

VOLTERA A Series

Installation and Setup Guide



A 300.2 A 600.2 A 300.4 A 600.4 Analog Amplifiers

Product Information Sources

- This guide covers installing and setting up the amplifier.
- Please see the product datasheets on Biamp.com for each Voltera amplifier's specifications.
- If you are installing the amplifier in an AV system managed by a Tesira DSP device, you will need a copy of the [Tesira Design Software](#). See page 18 for details.

Included in the Box

- 0.3" euroblock connector plugs for the amplified outputs (yellow)
 - 2 plugs for the 2-channel amps. 4 plugs for the 4-channel amps.
- 3.81mm audio input mating plugs
- Detachable IEC Power cord
- 4 adhesive feet
- 1 single device rack mounting bracket, 1 device rack mounting bracket, and 4 surface-mounting brackets.



Installation Considerations

- Install the device away from heat sources, such as vents, radiators, heat registers, and stoves.
- Do not exceed the maximum ambient operating temperature of 32° - 104° F (0° - 40° C).
- Avoid installing near water or steam.

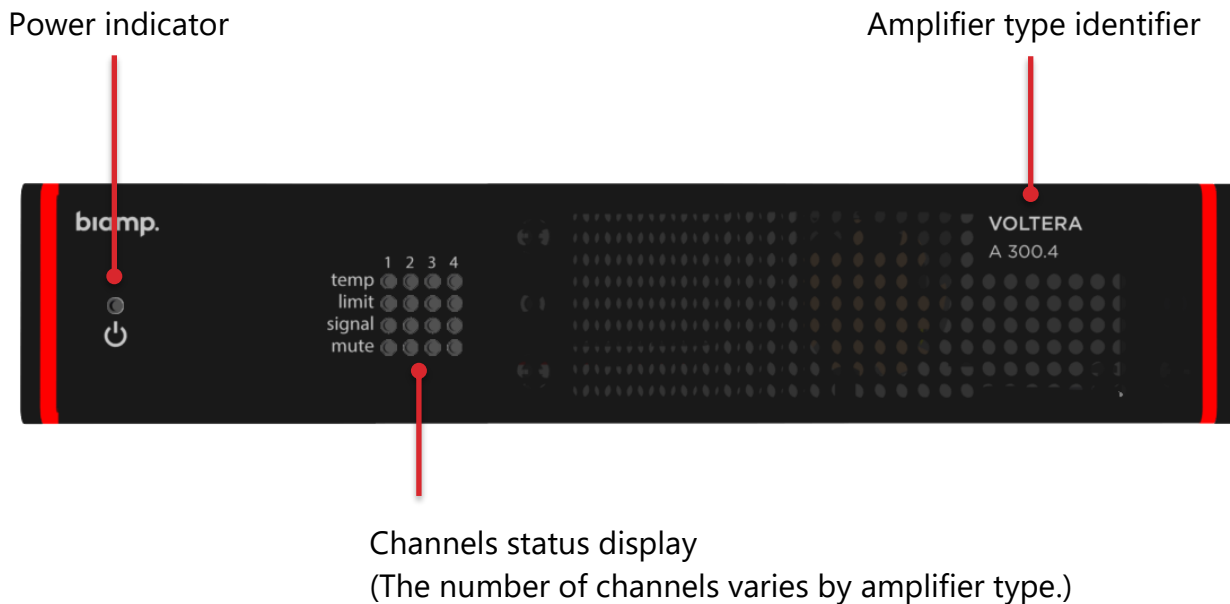

Device Layout

Front Panel







Front Panel LED Indicators

Power Indicator

-  Off The amplifier is off.
-  Green The amplifier is powered.
-  Yellow The amplifier is asleep.

Channel Status Indicators

	 Off	 Green	 Yellow	 Red
temp	Channel within safe temperature limits	N/A	Fan speed medium	Fan speed max
limit	Channel within safe limits	N/A	Channel limiting low to medium	Channel limiting high
signal	No signal	Signal present*	Signal 6 dB from maximum output	Signal 1 dB from max output
mute	Channel unmuted	N/A	N/A	Mute active

*A minimum signal strength of -56 dBu is required to register as present.

Back Panel Channel Status Indicators

Signal present is indicated with green. Yellow and red indicate the signal is strong enough to engage the limiter function. These states are also shown on the channel's front panel signal and limit indicators. See the chart above.

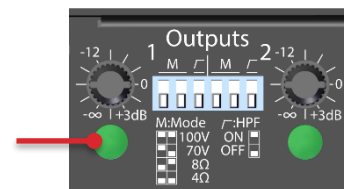

Firmware Version Indicator

The device's firmware version is identified using a sequence of lights on the Channel Status indicator LEDs representing two binary numbers.

- Read the LEDs from top to bottom.
- When an LED is on it represents a 1.
- When an LED is off it represents a 0.
- Channel 1 indicates the major version number.
- Channel 2 indicates the minor version number.

This example is displaying firmware version 1.5,

- Channel 1, only the mute LED is on, a binary of 0001, representing 1.
- Channel 2, the temp and signal LEDs are off whereas the limit and mute LEDs are on, a binary of 0101, representing 5.

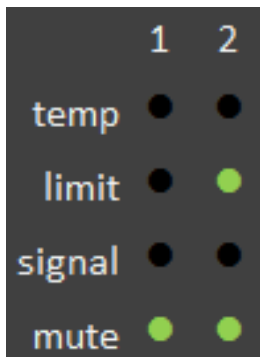

0 - 9 Binary representation:

0: 0000	5: 0101
1: 0001	6: 0110
2: 0010	7: 0111
3: 0011	8: 1000
4: 0100	9: 1001

Display the Firmware Version Indicator

Display the device's firmware version by booting it from a powered off state and the following will take place,

1. All the front panel LEDs flash green, then turn off briefly.
2. The device's firmware version displays, on channel 1 and 2, for 2 seconds.
3. All the front panel LEDs flash green briefly before the device returns to displaying normal channel statuses.

Note: If the device is held in sleep using the logic input, after the boot the device will remain in sleep mode and will not display the firmware version.

Firmware may be updated using the Voltera A Series firmware update tool, page 18.

A 300.2 and A 600.2 Back Panels

The amplifiers share an identical panel layout.

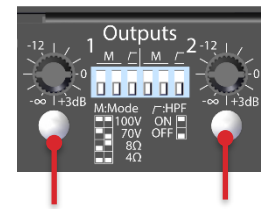
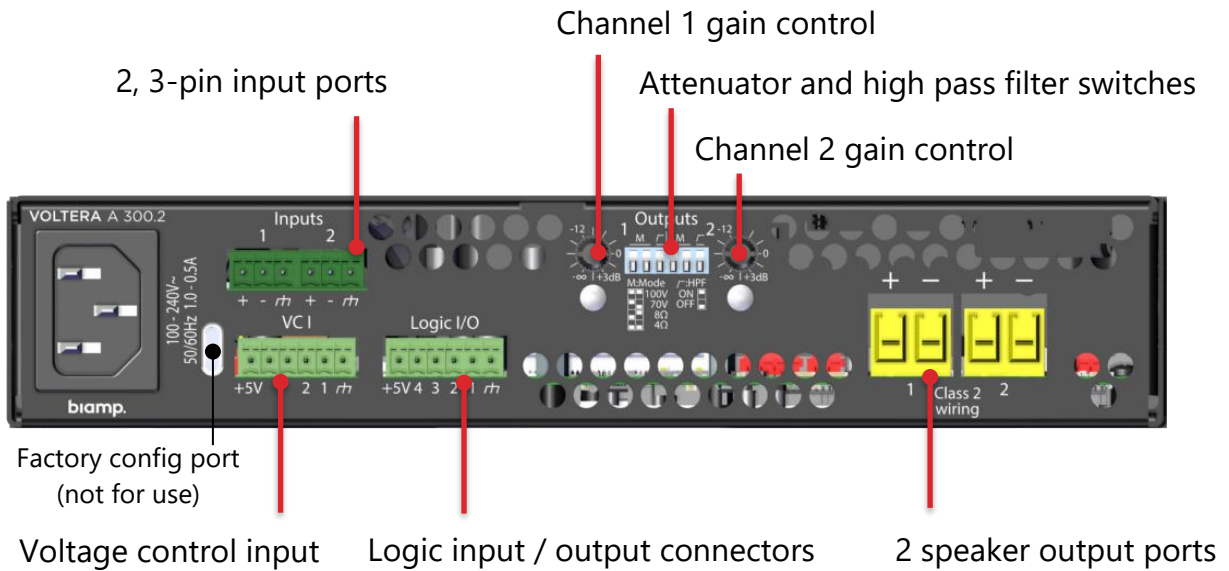

Limit / signal indicators

A 300.4 and A 600.4 Back Panels

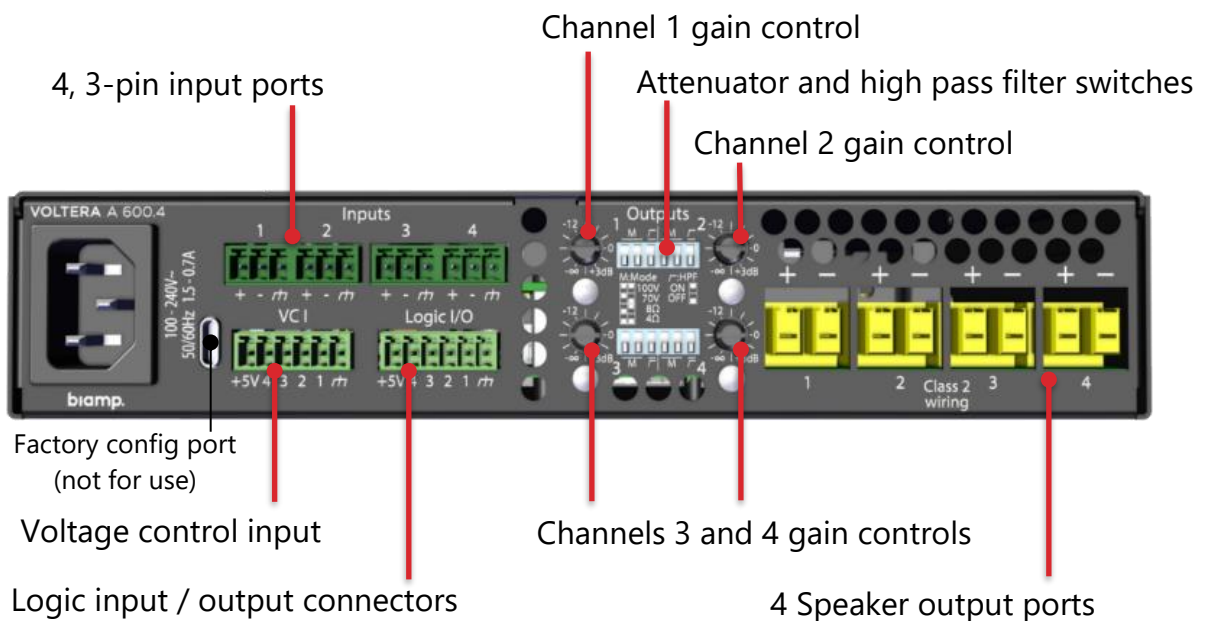

Included Mounting Brackets

1 Single-Device Rack Mounting Bracket



1 Device Rack Mounting Bracket



4 Surface Mounting Brackets



Installation and Setup Overview

Installation

Perform the procedures described in the Installation chapter to install the amplifier on a flat horizontal surface or in an AV equipment rack.

✓ Install in a location.

- Freestanding, page 8
- Surface mount, page 9
- A single amplifier in a 19-inch rack, page 10
- Dual amplifiers in a 19-inch rack, page 11

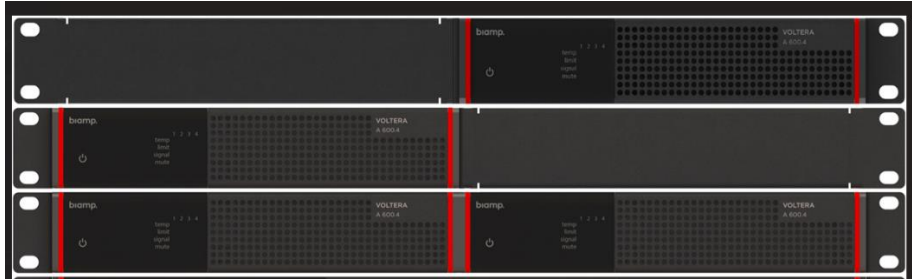

19-inch rack installation configurations using the included mounting brackets

✓ Connect the amplifier.

- Connect to its input, output, and other relevant devices in the system, page 13.
 - This section includes a description of the port functions and technical details.
 - Optional: Adjust the output gain levels.
 - Set the output power modes on each channel and set the High Pass Filter to on or off.
- Attach and plug in the power cord, page 17.

Amplifier Setup

Perform the procedures in the Setup chapter to configure the amplifier for use in a Tesira software-administered AV system.

✓ Configure the amplifier.

- Download the Tesira Design Software, page 18.
- Add the amplifier to the Tesira system and select its output speaker types, page 19.

Installation

Install Option: Freestanding

Place the amplifier on a flat horizontal surface.

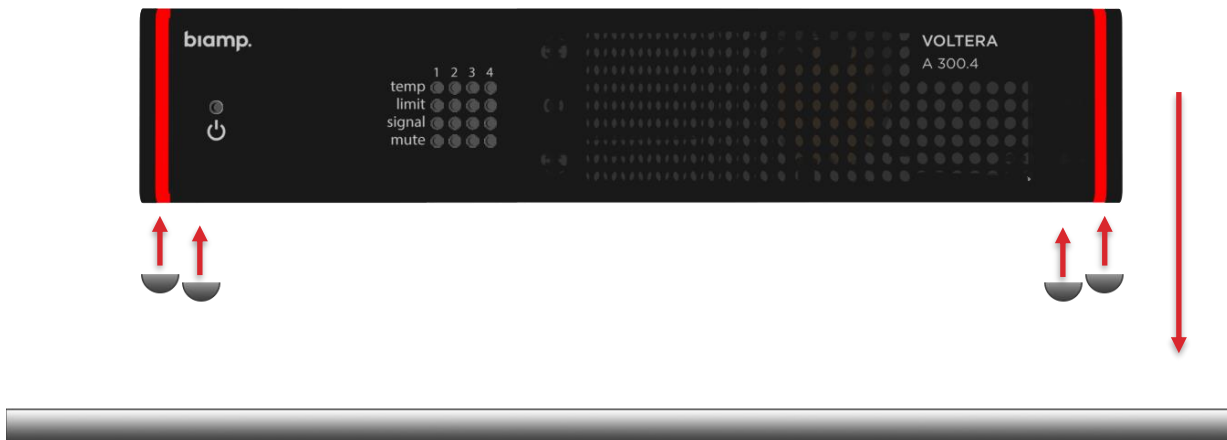

1. Verify the surface is flat and level, and that the amplifier's power cord and connections will be safely out of the way to avoid snagging, yanking, or crushing.
2. Attach the 4 included adhesive feet to the bottom of the amplifier. The 4 feet should be attached near the 4 corners.
3. Place the amplifier on the surface.

Advance to the connect the amplifier procedure on page 13.

Install Option: Surface Mount

Secure the amplifier to a flat surface using the surface mount brackets.

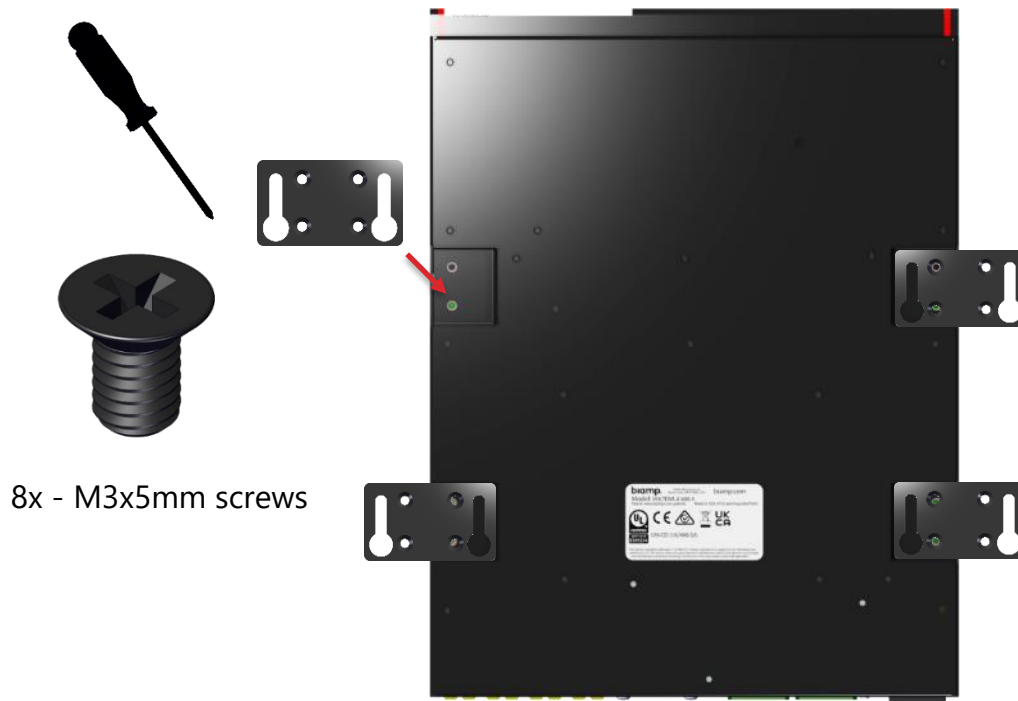

1. Verify the surface is flat and level, and that the amplifier's power cord and connections will be safely out of the way to avoid snagging, yanking, or crushing.
2. Use the included screws to fasten the 4 surface mounting brackets to the 4 attachment points on the bottom of the amplifier.

Note: Use only the provided M3 x 5mm screws. Using incorrect screws may damage the device.

3. Place the amplifier on the surface and fasten the mounting brackets to the surface.

Advance to the connect the amplifier procedure on page 13.

Install Option: A single amplifier in a 19-inch AV rack

Install a single amplifier by itself in an AV equipment rack using the included single-device mounting bracket and the device mounting bracket.

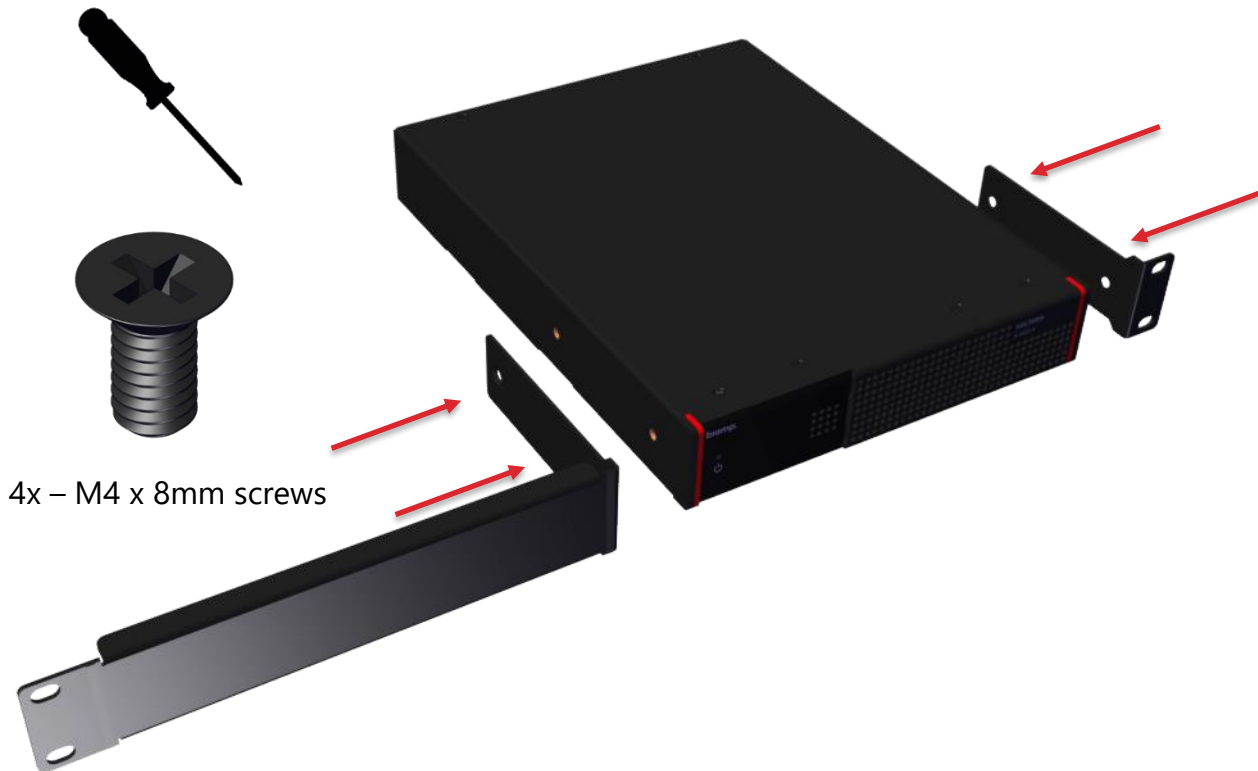

1. Verify the installation rack space meets the temperature and spacing requirements in the Installation Considerations section on page 2.
2. Attach the single-unit mounting bracket to the left or right side of the amplifier.
3. Attach the device mounting bracket to the opposite side of the amplifier.
4. Place the amplifier in the rack and use 2 of the included screws to secure the mounting plate to the rack.

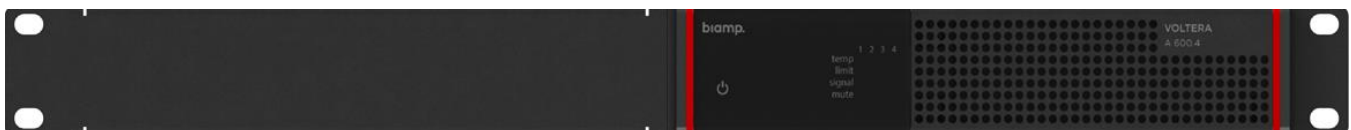

Advance to the Connect the Amplifier procedure on page 13.

Option: Dual devices in a 19-inch rack

Install two amplifiers side by side in a standard AV rack using the device mounting bracket included with each unit and two of the included surface mounting brackets.

1. Verify the installation rack space meets the temperature and spacing requirements in the Installation Considerations section on page 2.
2. Place both amplifiers side by side on their tops, with the bottom facing up. You are about to fasten the amplifiers together for installation, so their front panels must face in the same direction.

Note: Use only the provided M3 x 5mm screws. Using incorrect screws may damage the device.

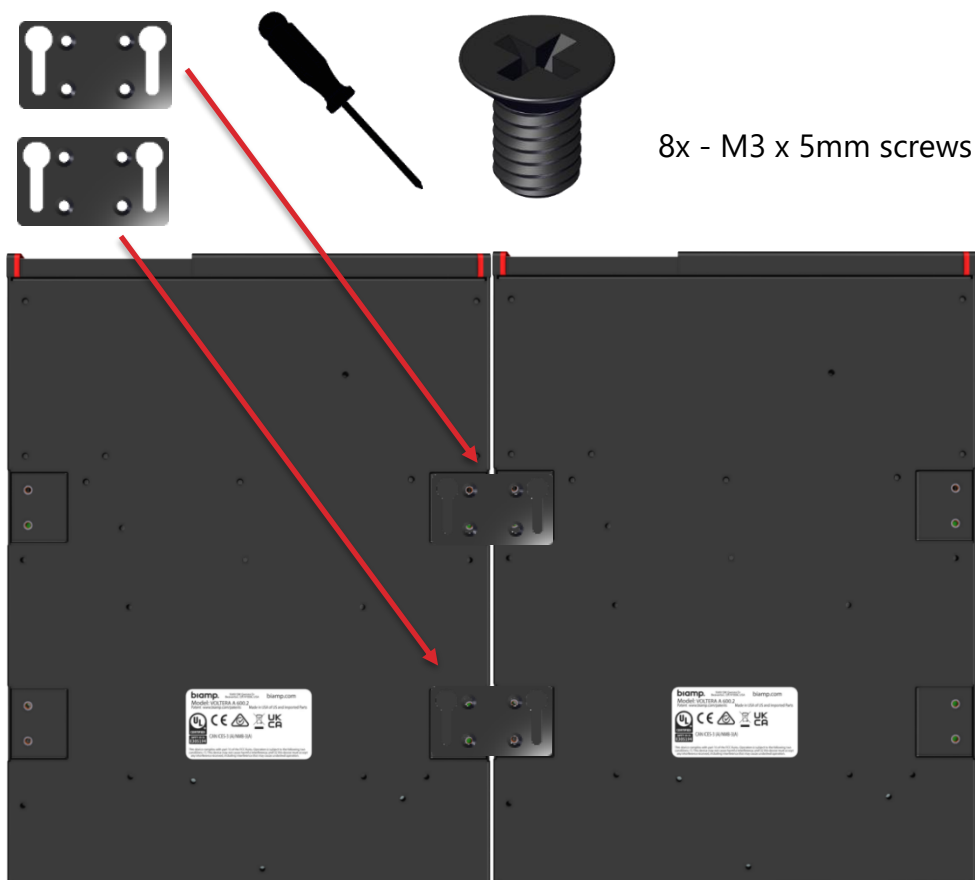

3. Attach 2 of the surface mounting brackets to the bottom of the 2 amplifiers on the surface-mount attachment points where the amplifiers meet. Each bracket should cover the adjoining mount points on both amplifiers.



4. Fasten the included device mounting bracket to the left side of the amplifier it came with. Then fasten the included device mounting bracket to the right side of the second amplifier.



5. Place the linked amplifiers in the rack and secure them in place.

Advance to the Connect the Amplifier procedure on page 13.

Connect the Amplifier and Set the Hardware Settings

Connect the amplifier to the input and output devices in the AV systems as well as any voltage control and input / output logic. See the descriptions in this section for the port functions.

Adjust the mode settings and turn on the high pass filter if required for your system.

Connect the Input Devices to the Input Ports

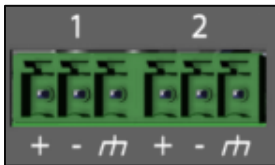

Connect input AV devices requiring signal boosting to line and speaker voltage levels to the 3-pin input ports.

Pitch: 3.81mm

Adjust the Output Gain

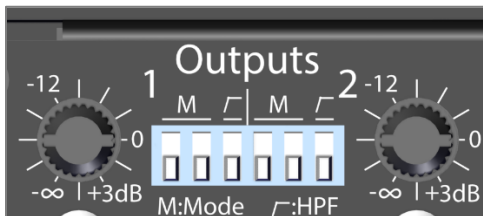

The default gain setting for each output channel is 0 dB. This provides a sensitivity of 4 dBu for rated program power. The gain can be adjusted from mute to +3 dB using the back panel dial control.

Limiter threshold: Increasing the gain over 0 dB also increases the limiter threshold for the channel. For example, +3 dB grants a doubled program power capacity on that channel.

Set the Output Mode and High Pass Filter

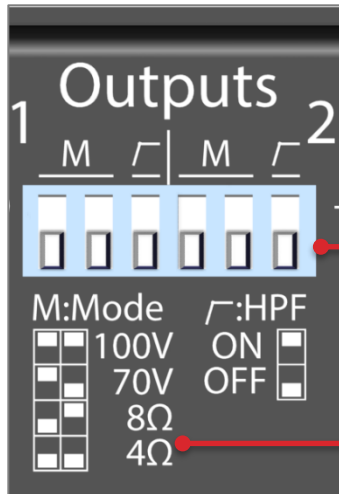

Switches: Each channel has 2 mode switches. These can be positioned in 4 combinations activating one of 4 output modes.

The \nearrow HPF switch is placed in either the ON or Off position.

Switch position diagram

Mode switches (M)

The 4 modes modify the gain structure and limiter thresholds.

- **100 Volts** - use this mode if the channel will drive a constant voltage 100 V circuit with peak power up to twice the nominal power.
- **70 Volts** - use this mode if the channel will drive a constant voltage 70 V circuit with peak power up to twice the nominal power.
- **8 Ω (ohm)** – use this setting if the loudspeaker will drive an impedance greater than 6 ohms.*
- **4 Ω (ohm)** - use this setting if the loudspeaker will drive an impedance lower than 6 ohms.*

*If power exceeding the rated program power is required, boost the gain trim above 0 dB. See page 13.

The Tesira Design Software can further assist in optimizing the amplifier's outputs.

High pass filter switch (HPF) \nearrow

- Adds 70Hz second-order high pass filtering when in the ON position.

Connections and Settings continued on the next page

Connect the Speakers to the Output Ports

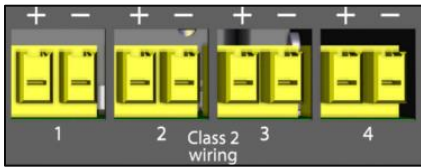

Keep the following points in mind.

- To minimize power loss, use a speaker cable of appropriate gauge for the load impedance.
- Use the supplied euroblock plugs to connect loudspeaker outputs.
- If stranded speaker wire is used, be sure to incorporate all strands into the connector, as stray strands can short to the adjacent terminal or chassis.
- Do not leave excessive bare wire outside the terminals, as this can lead to shorts.

Optional: Connecting the Volume Control Inputs

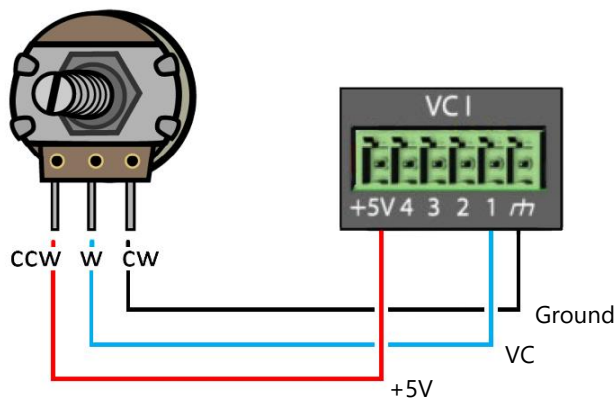

Note: Improperly wiring the potentiometer to the Voltera A may cause it to either function in reverse or not function.

Function: Output level adjustment. Provides 0V to 5V external volume control per input channel.

Pitch: 3.5mm

Recommended: 10k linear-taper potentiometer.

Potential: These ports are not potential-free.

A linear-taper potentiometer in the 5k-50k range is recommended. If a logarithmic (audio-tapered) potentiometer is used, the control will not seem to work evenly across the range.

The inputs do have noise filtering but for longer cable runs lower-value potentiometers in the 5k-10k range will have greater noise immunity.

Optional: Connecting the Logic Inputs and Outputs (I/Os)

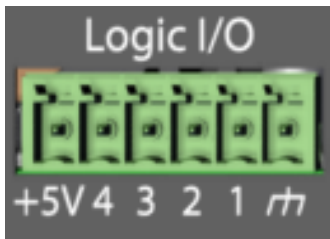

Pitch: 3.5mm

Pin Functions

Note – the pin functions are factory set.

- Pin 1 Input: Mute all
 - Active low
- Pin 2 Output: Health output
 - Fault exists if low
- Pin 3 Output: Sleep mode status
 - Unit asleep if low
- Pin 4 Input: Sleep mode
 - In sleep mode when low

Potential: These ports are not potential-free. External relays may be needed to prevent ground loops depending on the application.

Pin Data

- When activated, the I/O ports are tied to GND through a FET transistor.
 - Also known as an open drain or open collect function.
- +5V reference limited to 150mA

Plug in the Amplifier

Always use the detachable power cord that came with the amplifier or an identical replacement.



1. Attach the power cord to the power receptacle on the back of the amplifier.
2. Plug the connected power cord into the wall power outlet.

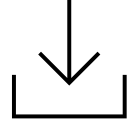

Amplifier Setup

For amplifiers being installed in a Tesira-managed AV system.

Downloading Tesira Design Software

You will need a copy of the Tesira Design Software when integrating the amplifier into an AV system managed by a Tesira DSP device such as a Tesira Server or a TesiraFORTÉ. The software enables the setup of a loudspeaker processing block preceding the amplifier in the system and provides help on configuring the output mode switches and gain settings for the loudspeakers.

Voltera A amplifiers can also be installed in non-Tesira systems. You do not need a copy of the Tesira Design Software for this type of system setup.

Download Site

The software can be downloaded from Biamp.com.

- Click here: [Tesira Software \(biamp.com\)](https://www.biamp.com/tesira-software)

Tesira Help System

The Tesira Software Help system provides instructions and overviews for using the Tesira Design software. It is typically embedded on digital Tesira system devices and can also be found online.

- [Tesira Help System \(Online\)](#)

Support Articles & Firmware Update Tool

Technical support articles for Tesira Software can be found on Biamp's Cornerstone knowledgebase support site.

- Click here: [Tesira - Biamp Cornerstone](#)

Cornerstone is also the location of the Voltera A Series firmware update tool.

- Click here: [Voltera A Amplifier firmware update tool - Biamp Cornerstone](#)

Training

Training courses for Tesira products and system core concepts are available online.

- Click here: [Biamp Training – In Person and Online Training, Certification Courses](#)

Configuring the Amplifier in a Tesira System

For Tesira-DSP-managed systems only. See the Tesira Help system described on the previous page for help configuring the speaker in the AV system.

1. Connect a computer with the Tesira software to the controller device for the AV system the amplifier is now installed in.
2. Use the Tesira software to add the amplifier to the AV system topology.
3. Select the speaker types the amplifier will output to.
4. Save and then upload the configuration file to the controller.



www.biamp.com



www.support.biamp.com

Support@biamp.com

9300 SW Gemini Drive Beaverton, OR 978008 USA

Warranty: biamp.com/legal/warranty-information

Safety & Compliance: biamp.com/compliance