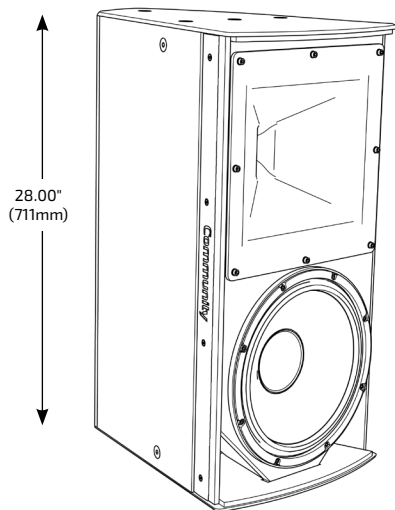

I SERIES
 Point Source 600

IP6-1122/66

 MEDIUM POWER 12-INCH TWO-WAY
 60° x 60° INSTALLATION LOUDSPEAKER

APPLICATIONS
MAIN PA (Small to Medium Size Venues)

 Houses of Worship · Auditoriums · Restaurants
 Meeting Rooms · Theaters · Corporate A/V Systems

DISTRIBUTED OR FILL (Larger Size Venues)

 Arenas · Stadiums · Night Clubs · Theaters
 Themed Entertainment · Larger Houses of Worship

DESCRIPTION

I SERIES Point Source 600 loudspeakers provide excellent acoustic performance, modular flexibility and elegant aesthetics for modern performance venues. Designed to support the goals of systems integrators and consultants both acoustically and mechanically, I SERIES includes a wide variety of arrayable, rotatable coverage patterns and a comprehensive selection of modular bracket systems that accelerate system design and system commissioning.

FEA-optimized ferrite motors, mechanically mirrored suspension and advanced cooling system combine to provide linear performance with minimal power compression. The custom long-excursion LF driver delivers deep bass response and a detailed midrange at maximum SPL levels. The HF driver delivers excellent sound quality from a hybrid diaphragm of deep drawn titanium and resonance-absorbing polyimide, coupled to a patented low compression, low resonance phase plug for very low distortion performance with abundant headroom.

The rotatable 13-inch (330mm) HF waveguide provides well-defined coverage and a smooth off-axis response that enhances arrayability. Individually voiced crossovers produce proper beamwidth matching transitions and identical sonic signatures, permitting horn patterns to be mixed throughout an installation. Additionally, user selectable single-amp or biamp operating modes expand application flexibility.

FEATURES

- Long excursion ferrite LF driver with FEA-optimized motor and symmetric movement suspension
- 3-inch voice coil, 1.4" exit HF driver; hybrid titanium/polyimide diaphragm on low compression phase plug
- Lightweight and compact with deep LF extension
- Large rotatable waveguide with individually voiced crossover, single amp / biamp selectable
- Innovative low profile modular bracket systems create elegant arrays with simplified installation

TECHNICAL SPECIFICATIONS¹

Operating Mode	Passive or Biamped with DSP		
Operating Environment	Indoor or Weather-Resistant Outdoor		
Operating Range²	38 Hz to 18.5 kHz		
Nominal Beamwidth (H x V)	60° x 60°, rotatable waveguide		
Transducers	LF 1 x 12" (305mm) ferrite driver, 2.5" (64mm) voice coil HF 1 x 1.4" (36mm) exit, 3" (76mm) voice coil, hybrid titanium/polyimide diaphragm, ferrite compression driver		
Continuous Power Handling³ @ Nominal Impedance	Passive*	69V	600W @ 8 ohms (2400W peak)
	LF	63V	500W @ 8 ohms (2000W peak)
	HF	24V	75W @ 8 ohms (300W peak)
Nominal Sensitivity⁴	Passive	@ 1W	@ 2.83V
	LF	95 dB	95 dB
	HF	108 dB	108 dB
Nominal Maximum SPL⁵ (Whole Space)	Passive	Peak	Continuous
	LF	129 dB	123 dB
	HF	128 dB	122 dB
	HF	133 dB	127 dB
Equalized Sensitivity⁶	System	@ 1W	@ 2.83V
		93 dB	93 dB
Equalized Maximum SPL⁷	System	Peak	Continuous
		127 dB	121 dB
Recommended Amplifiers	Passive	600W - 1200W @ 8 ohms, (69V - 98V)	
	LF	500W - 1000W @ 8 ohms, (63V - 89V)	
	HF	75W - 150W @ 8 ohms (24V - 35V)	

PHYSICAL

Input Connection	Indoor: (2) Screw terminal blocks (6-position) Outdoor: Sealed Gland Nut with 12ft (3.6m) 14 Ga. SJOW cable
Mounting Points	(15) M10 threaded rigging points
Environmental	Outdoor: IP55W per IEC 60529, MIL-STD-810G
Weight	65.0 lbs (29.5 kg) loudspeaker only
Dimensions H x W x D	28.00" x 14.50" x 17.70" (711 x 368 x 450 mm)
Finish	Refer to the Technical Drawing

OPTIONS

Accessories (Refer to BalancePoint™ Flyware Accessory Guide for complete listing)	<i>Rigging kits include:</i> BFR22: BalancePoint™ Fly Rails; IUB1122: U-Bracket; IVY1122: Vertical Yoke; IAF40/IAF55: Isometric Array Frames; VAB-BFR38: Sub Above Vert Array; HAB-BFR38: Sub/Dual 2-Way Horiz Array; HSB/VSB: Multiple Splay Brackets for Horiz/Vert Arrays with/without Sub Behind options; DFS: Downfill Splay Kit; DVS-BFR22: Dual Vert Splay Kit with BalancePoint™ Fly Rails; IUB1122WRG: Reinforced 3045S U-Bracket (Grey)
Configure-to-Order (CTO)	Custom color, Custom cable lengths on outdoor version

¹Rated continuous maximum input voltage at passive loudspeaker input may be higher than for directly connected transducers due to losses in the passive crossover. Voltages applied to the transducer terminals through the passive crossover shall always be the same or lower than the rated continuous voltage for each device.

AXIAL PROCESSED RESPONSE (dB)⁸

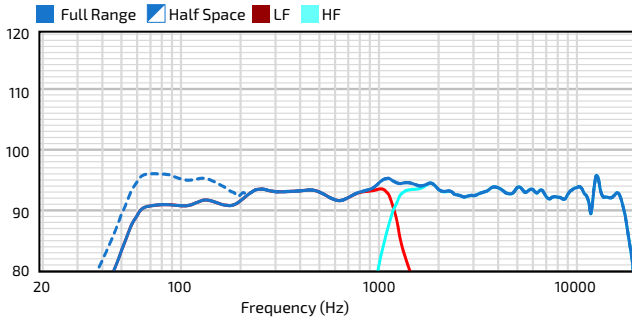

HORIZONTAL OFF-AXIS RESPONSE (dB)¹⁰

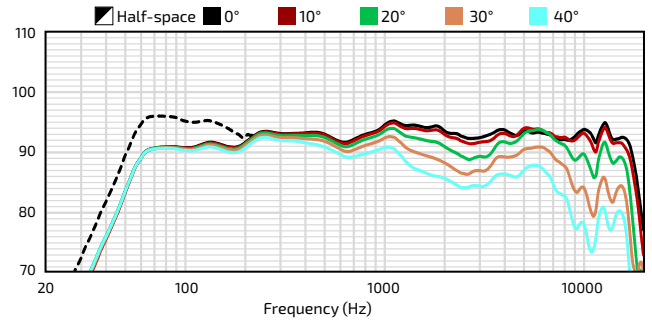

AXIAL SENSITIVITY (dB SPL)⁹

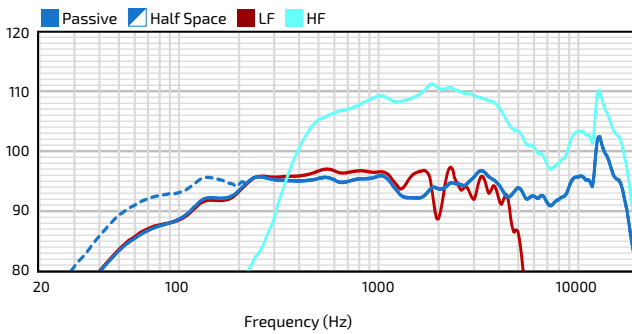

VERTICAL OFF-AXIS UP RESPONSE (dB)¹⁰

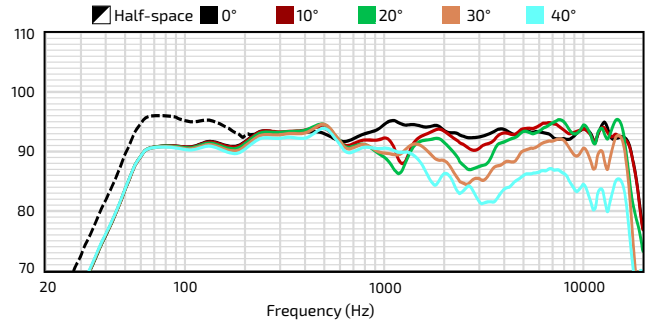

IMPEDANCE (Ohms)

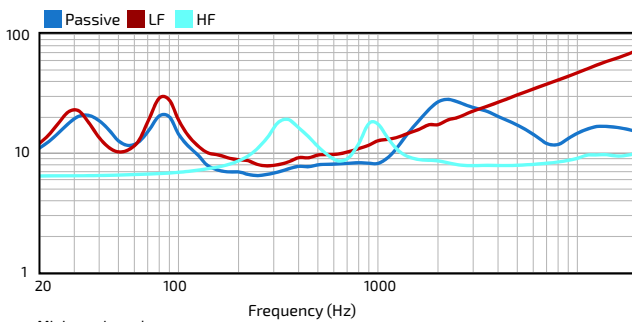

VERTICAL OFF-AXIS DOWN RESPONSE (dB)¹⁰

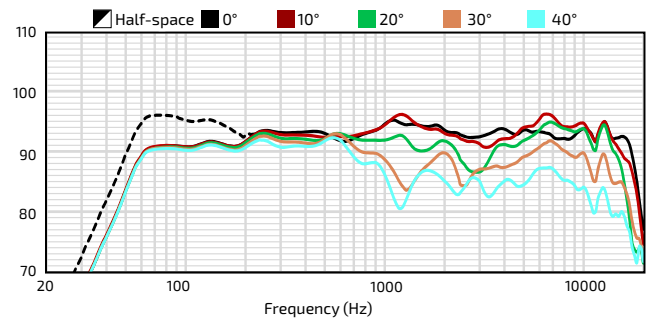

Minimum Impedance:
(Passive) 6.5 ohms @ 250 Hz, (LF) 7.8 ohms @ 280 Hz, (HF) 7.9 ohms @ 4500 Hz

DIRECTIVITY INDEX (dB)¹¹

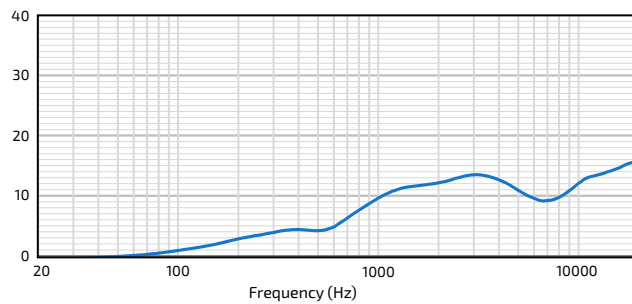

BEAMWIDTH (Degrees)¹²

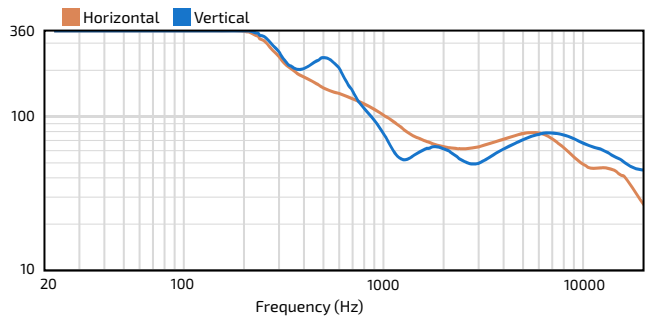

HORIZONTAL POLAR DATA (30dB Scale, 6dB per major division)

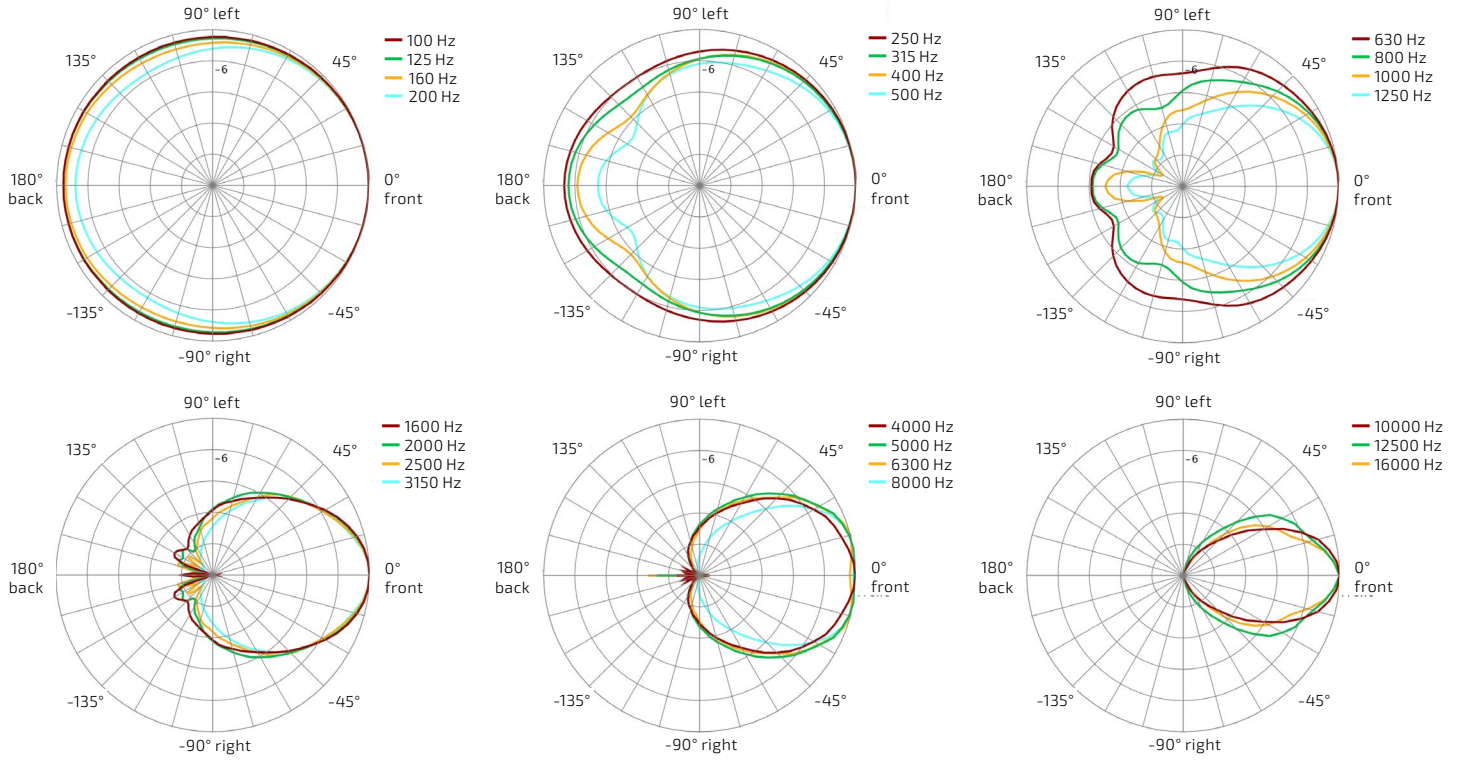

VERTICAL POLAR DATA (30dB Scale, 6dB per major division)

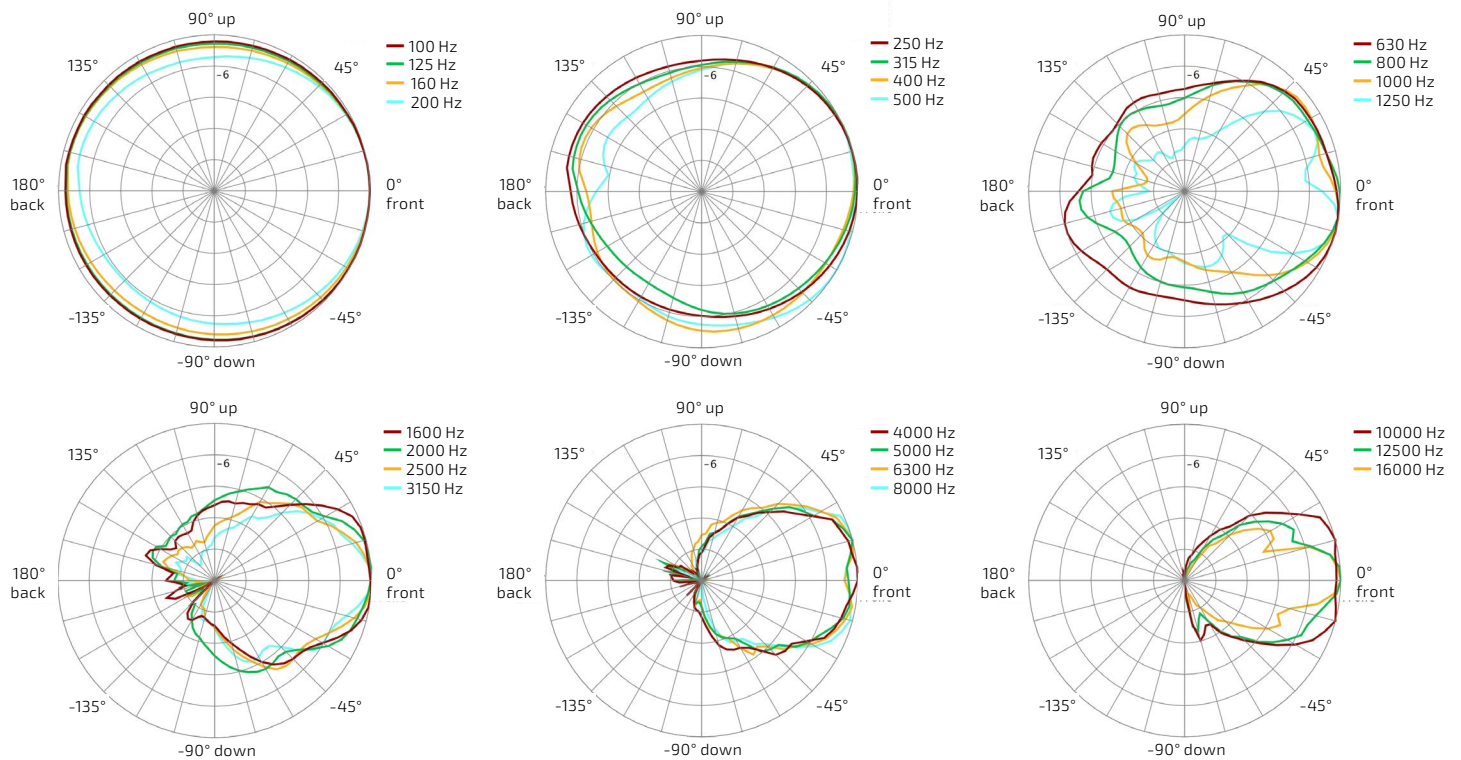

IP6-1122/66

MEDIUM POWER 12-INCH TWO-WAY
60° x 60° INSTALLATION LOUDSPEAKER

TECHNICAL DRAWING / DIMENSIONS / FINISH

H x W x D
28.00" x 14.50" x 17.70"
(711 x 368 x 450 mm)

Unit Weight
65.0 lbs (29.5 kg) loudspeaker only

Shipping Weight
74 lbs (33.6 kg)

Indoor Models:
Grille: Powder-coated perforated steel backed with color-matched acoustically transparent woven fabric. Black (RAL#9005) or White (RAL#9003)
Enclosure / Finish: Black (RAL#9004) or White (RAL#9003) low gloss, uniformly textured painted 15mm Baltic Birch plywood.

***Outdoor Models:**
Grille: Marine grade aluminum with zinc-rich dual-layer powder-coat, featuring NeverWet™ treated acoustically transparent woven black fabric backing. Grey (RAL#7047)
Enclosure / Finish: 15mm PolyGlas™, Grey, heavily textured industrial-grade exterior-rated coating. Black, White or Custom colors upon request.

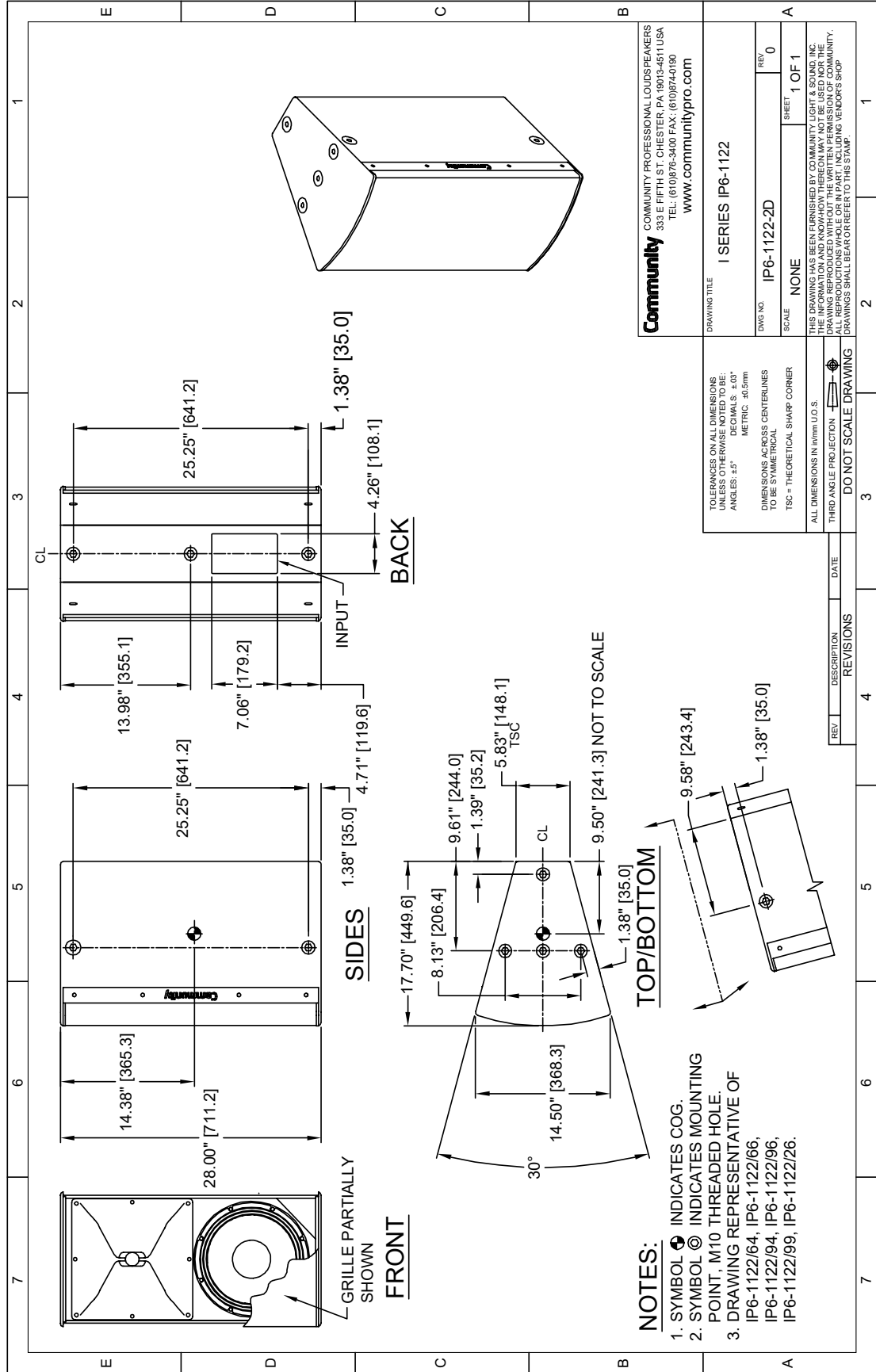

*Note: The outdoor model drawing is available at biamp.com - Input panel and mounting point locations and the unit weight may vary from indoor model (shown).

I SERIES

Point Source 600

IP6-1122/66

MEDIUM POWER 12-INCH TWO-WAY
60° x 60° INSTALLATION LOUDSPEAKER

CONNECTION DIAGRAMS

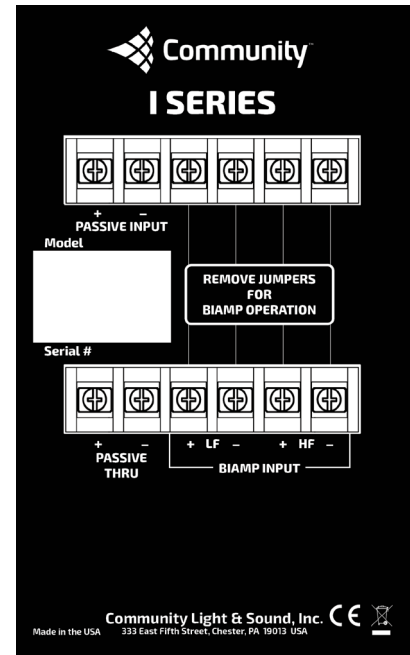
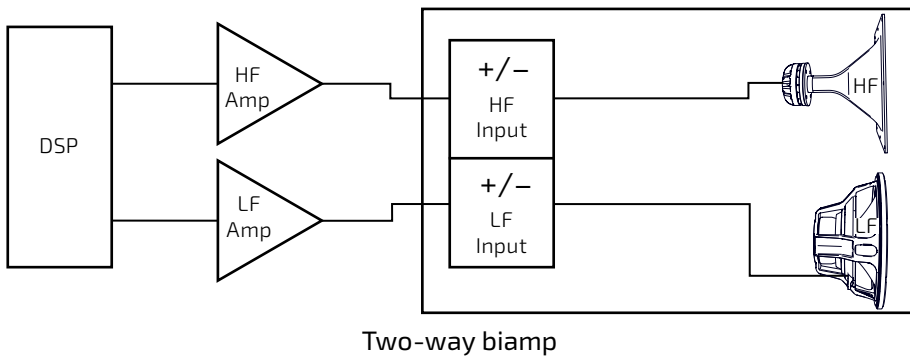
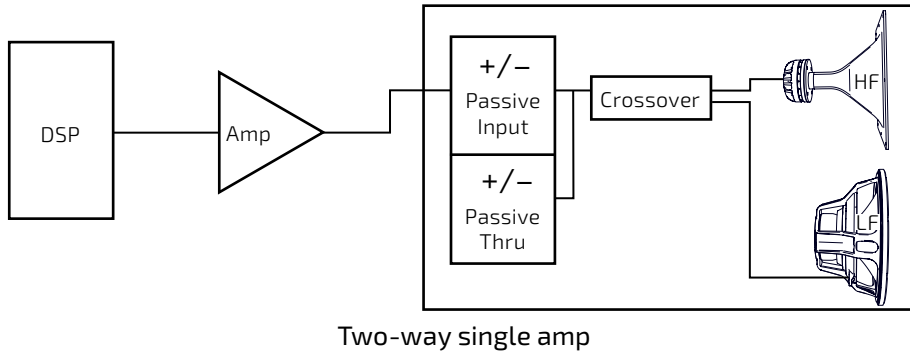

NOTES

- PERFORMANCE SPECIFICATIONS** All measurements are taken indoor using a time-windowed and processed signal to eliminate room effects, approximating an anechoic environment, a distance of 6.0 m. All acoustic specifications are rounded to the nearest whole number. An external DSP with settings provided by Community Professional Loudspeakers is required to achieve the specified performance; further performance gains can be realized using Community's dSPEC226 loudspeaker processor with FIR power response optimization.
- OPERATING RANGE** The frequency range in which the on-axis processed response remains within 10dB of the average SPL.
- CONTINUOUS POWER HANDLING** Maximum continuous input voltage (and the equivalent power rating, in watts, at the stated nominal impedance) that the system can withstand, without damage, for a period of 2 hours using an EIA-426-B defined spectrum; with recommended signal processing and protection filters.
- NOMINAL SENSITIVITY** Averaged SPL over the operating range with an input voltage that would produce 1 Watt at the nominal impedance and the averaged SPL over the operating range with a fixed input voltage of 2.83V, respectively; swept sine wave axial measurements with no external processing applied in whole space, except where indicated.
- NOMINAL MAXIMUM SPL** Calculated based on nominal / peak power handling, respectively, and nominal sensitivity; exclusive of power compression.
- EQUALIZED SENSITIVITY** The respective SPL levels produced when an EIA-426-B signal is applied to the equalized loudspeaker system at a level which produces a total power of 1 Watt, in sum, to the loudspeaker subsections and also at a level which produces a total voltage, in sum, of 2.83V to the loudspeaker subsections, respectively; each referenced to a distance of 1 meter.
- EQUALIZED MAXIMUM SPL** The SPL produced when an EIA-426-B signal is applied to the equalized loudspeaker system, at a level which drives at least one subsection to its rated continuous input voltage limit, referenced to a distance of 1 meter. The peak SPL represents the 2:1 (6dB) crest factor of the EIA-426-B test signal.
- AXIAL PROCESSED RESPONSE** The on-axis variation in acoustic output level with frequency of the complete loudspeaker system with recommended signal processing applied. 1/6 octave Gaussian smoothing applied.
- AXIAL SENSITIVITY** The on-axis variation in acoustic output level with frequency for a 1 Watt swept sine wave, referenced to 1 meter with no signal processing. 1/6 octave Gaussian smoothing applied.
- HORIZONTAL / VERTICAL OFF-AXIS RESPONSES** The loudspeaker's magnitude response at various angles off-axis, with recommended signal processing applied in the operating mode which utilizes the largest number of individually amplified pass bands. 1/6 octave Gaussian smoothing applied.
- DIRECTIVITY INDEX** The ratio of the on-axis SPL squared to the mean squared SPL at the same distance for all points within the measurement sphere for each given frequency; expressed in dB. 1/6 octave Gaussian smoothing applied.
- BEAMWIDTH** The angle between the -6dB points in the polar response of the loudspeaker when driven in the operating mode which utilizes the largest number of individually amplified pass bands. 1/6 octave Gaussian smoothing applied.

Data presented on this spec sheet represents a selection of the basic performance specifications for the model. These specifications are intended to allow the user to perform a fair, straightforward evaluation and comparison with other loudspeaker spec sheets. For a detailed analysis of this loudspeaker's performance, please download the GLL file and/or the CLF file from our website: biamp.com.

CAUTION: Installation of loudspeakers should only be performed by trained and qualified personnel. It is strongly recommended that a licensed and certified professional structural engineer approve the mounting design.