



PC 5T / PC 8T Plastic ceiling loudspeakers

TECHNICAL SPECIFICATIONS



PC 5T / PC8T

PC T - ABS plastic ceiling loudspeakers with built-in 100V transformer with power taps.

Excellent full range sound, used where a combination of high quality background music and public address are required. These loudspeakers are designed to be quickly and simply installed into false ceilings. Wide sound dispersion and innovative neutral design makes these loudspeakers useful in a variety of applications, restaurants, bars, cafes, shops, offices, moles and large public spaces for background music and speech announcements.

	PC 5T	PC 8T
Rated power	10 W	20 W
Transformer power taps	10 W - 5 W - 2,5 W - 1,25 W	20 W - 10 W - 5 W - 2,5 W
Sensitivity	88 dB (1 W/1 m)	88 dB (1 W/1 m)
Maximum SPL	98 dB (Pmax/1 m) at 15694 Hz	101 dB (Pmax/1 m) at 15249 Hz
Frequency response	90 Hz – 20 kHz	80 Hz – 20 kHz
Dispersion at 1000 Hz	120° conical	120° conical
Driver dimensions	5" (130 mm) woofer, 0,5" (13 mm) tweeter, coaxial	8" (200 mm) woofer, 0,5" (13 mm) tweeter, coaxial
Dimensions	ø 190 mm × 70 mm	ø 245 mm × 95 mm
Weight	1,1 kg	2,1 kg
Material	Plastic	Plastic
Colour	White (RAL 9016)	White (RAL 9016)

PC 5T

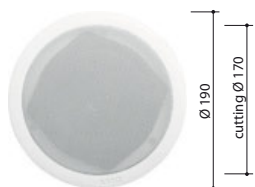

PC 8T

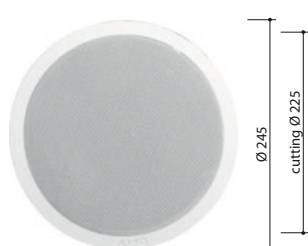

unit: mm



PC 8T Plastic ceiling loudspeakers

FREQUENCY DIAGRAMS

TECHNICAL SPECIFICATIONS

Rated power	20 W
Transformer power taps	20 W – 10 W – 5 W – 2,5 W
Sensitivity (1 m/1 W)	88 dB
Maximum SPL	101 dB
Driver impedance	8 Ohm
Frequency response	80 Hz – 20 kHz
Dispersion at 1000 Hz, degrees	120° conical
Driver dimensions	200 mm woofer, 13 mm tweeter, coaxial
Dimensions	ø 245 mm × 95 mm
Weight	2,1 kg
Material	Plastic
Colour	White (RAL 9016)

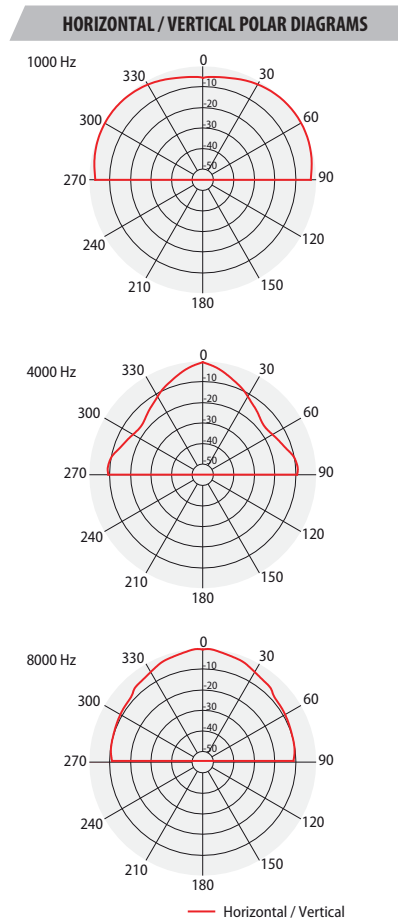
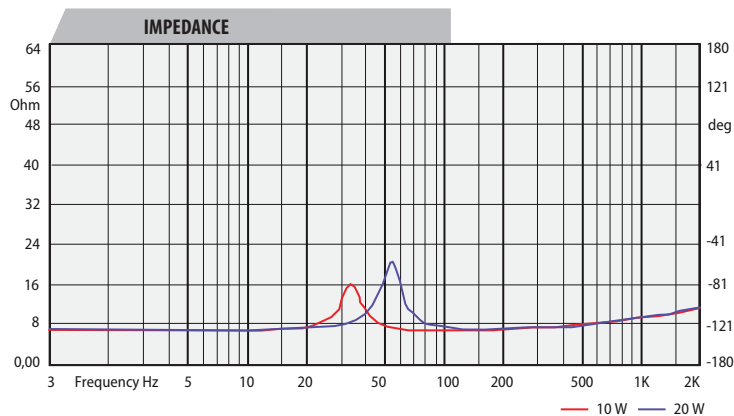
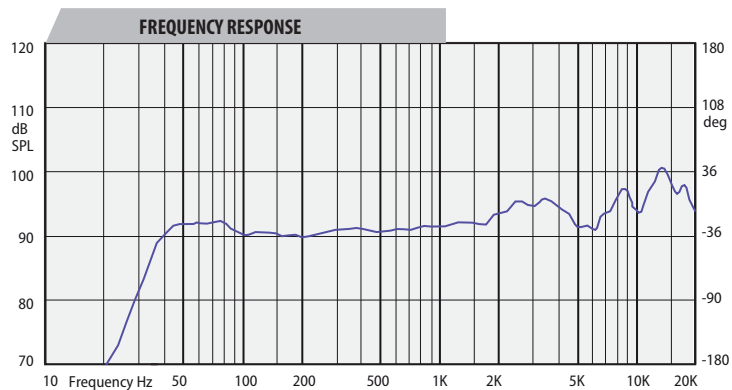

PC 5T Plastic ceiling loudspeaker

INSTALLATION MANUAL

- ① Cut out Ø 170 mm hole for PC 5T.

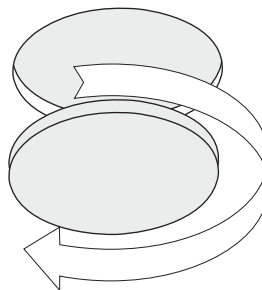

- ② Remove the front grill.

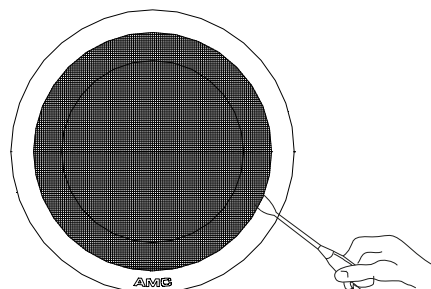

- ③ Connect speaker to signal line via block terminal.

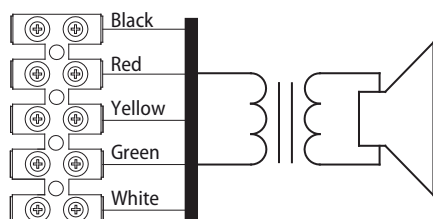

COLOR	PC 5T
Black	COM
Red	1.5 W
Yellow	2.5 W
Green	5 W
White	10 W

- ④ Carefully push speaker in the cut hole and fix the loudspeaker with mounting screws.

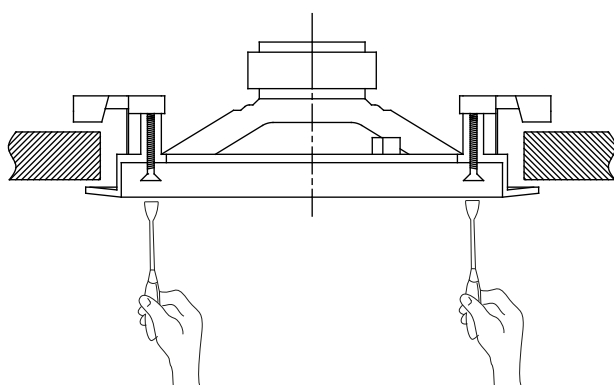

- ⑤ Mount the grill on the loudspeaker.