

PROFESSIONAL SERIES

SURFACE MOUNT WOOFER PS-S83WT



Introducing the Sonance Professional Series

From Sonance, the company that created the architectural audio category comes a range of professional loudspeakers that set a new benchmark in sound quality and aesthetics for commercial environments.

Sonance Professional Series includes a range of In-Ceiling, Pendant and Surface Mount Speakers that deliver unequalled fidelity, extremely low distortion, wide dispersion and a smooth power response. The range also shares consistent voicing, ensuring seamless sonic integration when used together throughout a space.

Sonance Professional Series PS-S83WT Surface-Mount Woofer features the Patented FastMount® bracket and front cable connection to speed up the installation process and provide a clean appearance.

The IPX4 rated construction features a weatherproof high-impact, extreme temperature resistant cabinet and corrosion-proof powder coated aluminum grille, lending itself perfectly in both indoor and outdoor applications.

An ultra-high-excursion 8" polypropylene woofer delivers effortless and impactful low bass extension and augmentation, at any sound pressure level.

Additionally, the Sonance PS-S83WT is certified for UL 1480.

Available in either black or white (paintable).

Features & Benefits

Performance

- Class-leading sensitivity & sonic performance
- Exceptional off-axis response
- Heavy-duty voice coil for longevity and reliability
- Full-fidelity transformer for uncompromised 70V/100V tonality
- Consistent voicing across product range

Aesthetics

- Clean and minimalistic design
- Available in black or white (paintable)

Installation

- FastMount® bracket system for easy installation
- Front-located cable connector and tap selector
- Connector and tap selector cover
- Corrosion-resistant powder coated aluminum grille

Applications

- Shopping Malls, Retail Spaces & Showrooms
- Restaurants, Bars & Lounges
- Galleries, Museums & Amusement Parks
- Casinos, Convention Centers & Hotels
- Houses of Worship & Educational Facilities
- Sporting Facilities
- Marinas, Piers & Wharfs



Specifications



PS-S83WT
WHITE

PS-S83WT
BLACK

SKU# 40146 (WHITE)

SKU# 40151 (BLACK)

LOUDSPEAKER

Frequency Range (-10dB):	32Hz – 300Hz
Frequency Range (-3dB):	50Hz – 150Hz
Power Capacity:	200 Watts Continuous Program Power 125 Watts Continuous Pink Noise
Nominal Sensitivity:	88dB
Nominal Coverage Angle:	180 degrees x 180 degrees coverage
Directivity Factor (Q):	N/A
Directivity (DI):	N/A
Rated Maximum SPL:	110dB @ 1 meter (3.3 feet) average, 116dB peak
Rated Impedance:	8 Ohms nominal, 6 Ohms minimum
Transformer Taps:	70V: 120W, 60W, 30W and 15W 100V: 120W, 60W and 30W
Crossover Point:	150Hz
Overall Dimension:	14.02" Height x 9.01" Width x 8.58" Depth (356mm x 229mm x 218mm)
Net Weight:	16.08 lbs (7.62kg) each
Shipping Weight:	21.49 lbs (9.75kg) each
Unit of Measure:	Each
Color:	Black or White
Grille:	Powder Coated Aluminum Friction Fit

TRANSDUCERS

LF Driver:	8" (203mm) Polypropylene Cone, Butyl Rubber Surround
HF Driver:	N/A

ENCLOSURE

Input Connectors:	Front-mounted four pin, Euroblock with loop output connections
Safety Agency:	UL 1480, UL 2239, NFPA 70
Mounting Bracket:	U-Bracket with Sonance FastMount
Environmental & UV:	Conforms to MIL-STD-810 for humidity, salt spray, temperature, IEC 529 IPX4 splash-proof rating

Included Accessories

- Euroblock Connector x 1
- FastMount Bracket x 1
- Terminal Cover x 1
- Grille x 1

Optional Accessories

- Replacement Grille White (pair) | 93166
- Replacement Grille Black (pair) | 93167

Performance Measurements

1 METER ON AXIS FREQUENCY RESPONSE

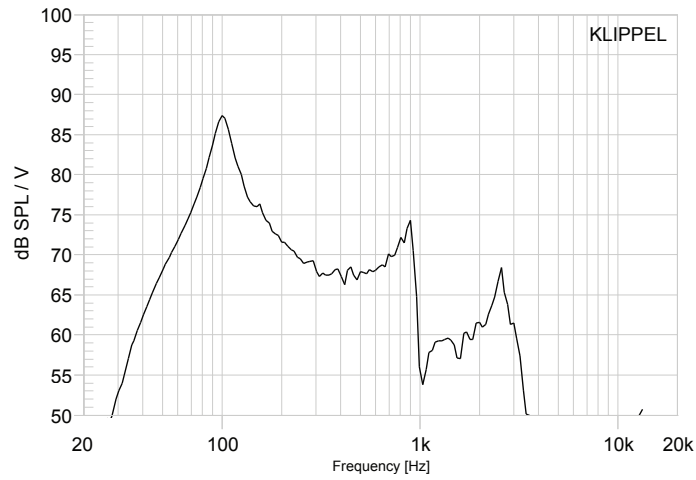

IMPEDANCE vs FREQUENCY

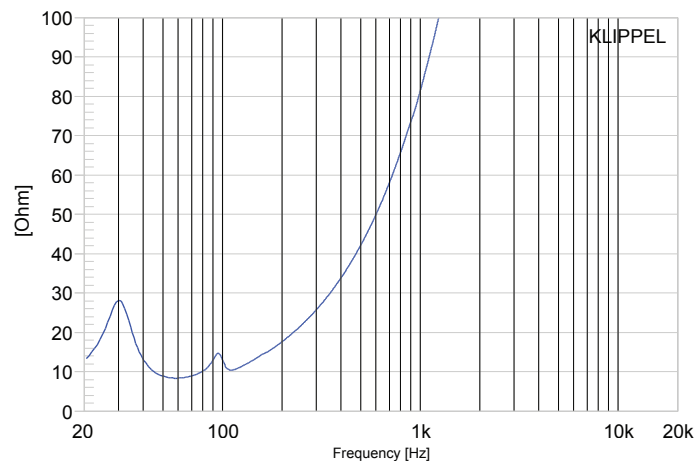

1 METER HORIZONTAL FREQUENCY RESPONSE

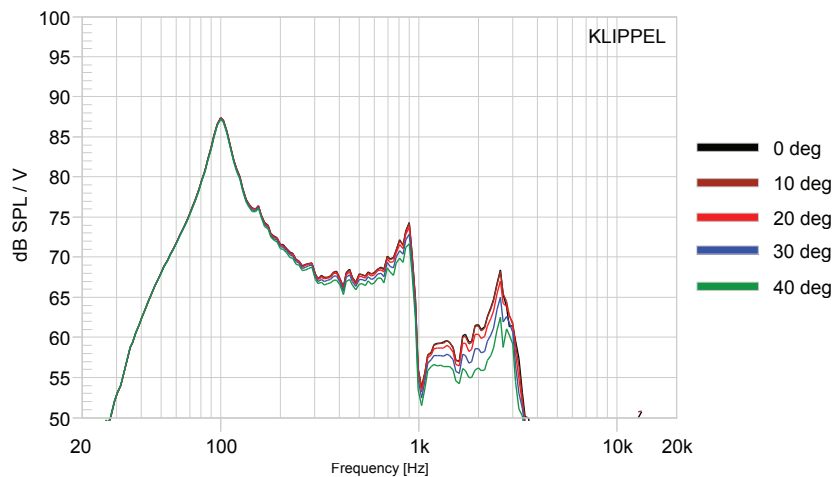

Performance Measurements

BEAMWIDTH vs FREQUENCY

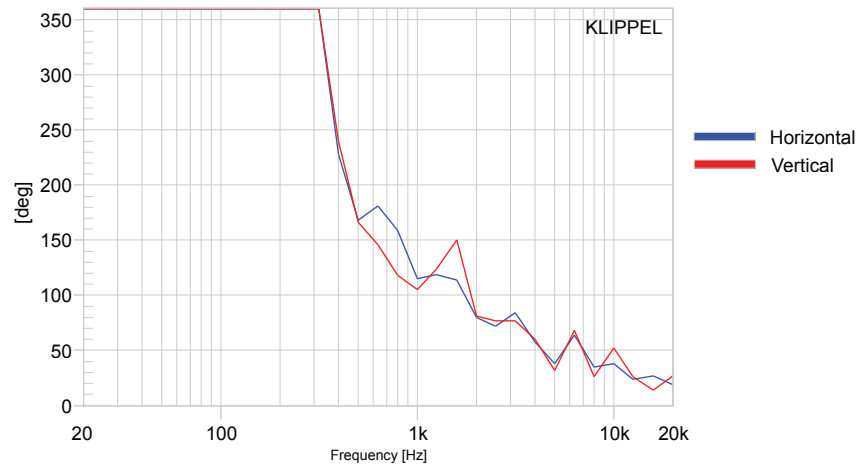

DIRECTIVITY INDEX vs FREQUENCY

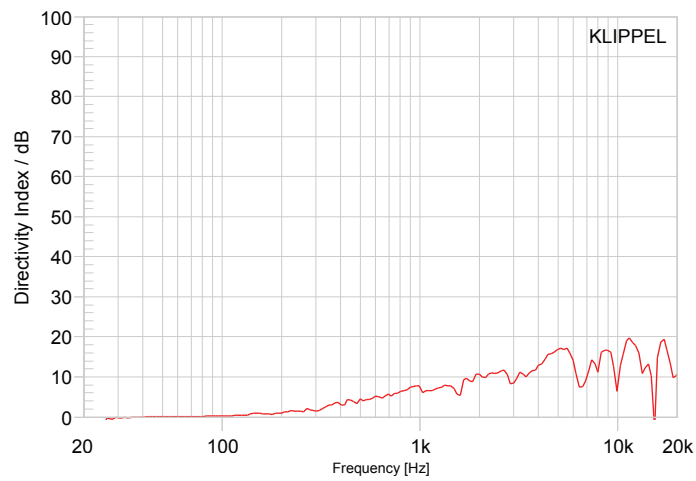

1 METER VERTICAL FREQUENCY RESPONSE

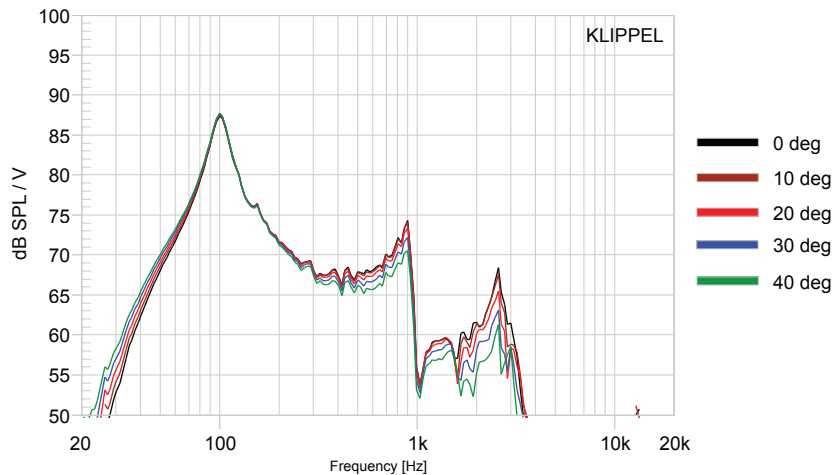

Polar Plots (1/3 Octave)

RATIO vs ANGLE

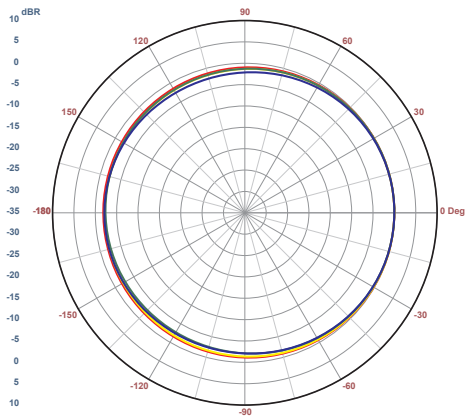

Curve	Freq	BW	Q	DI
Red	100.00	360	1.0	0.0
Yellow	125.00	360	1.0	0.0
Green	160.00	360	1.0	0.0
Blue	200.00	360	1.0	0.0

RATIO vs ANGLE

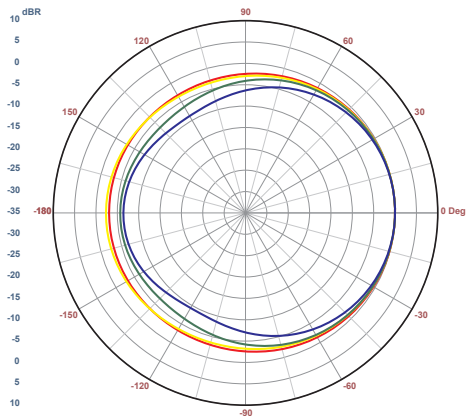

Curve	Freq	BW	Q	DI
Red	250.00	360	1.0	0.0
Yellow	315.00	360	1.0	0.0
Green	400.00	225	1.6	2.0
Blue	500.00	187	2.2	3.3

RATIO vs ANGLE

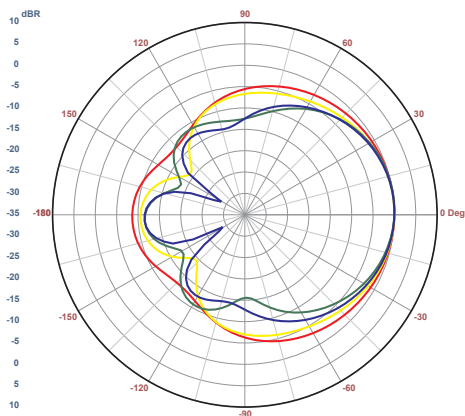

Curve	Freq	BW	Q	DI
Red	630.00	178	2.0	3.1
Yellow	800.00	153	2.4	3.7
Green	1.00K	102	3.5	5.5
Blue	1.25K	116	3.1	4.9

RATIO vs ANGLE

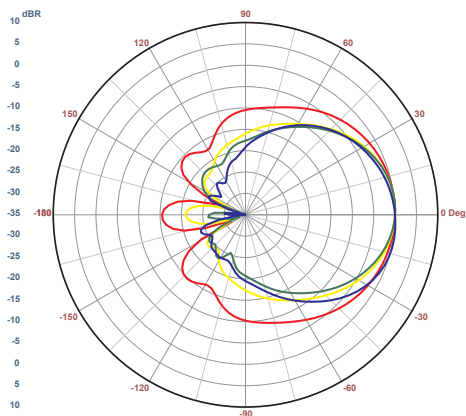

Curve	Freq	BW	Q	DI
Red	1.60K	113	3.2	5.0
Yellow	2.00K	76	4.7	6.7
Green	2.50K	69	5.2	7.2
Blue	3.15K	80	4.5	6.5

RATIO vs ANGLE

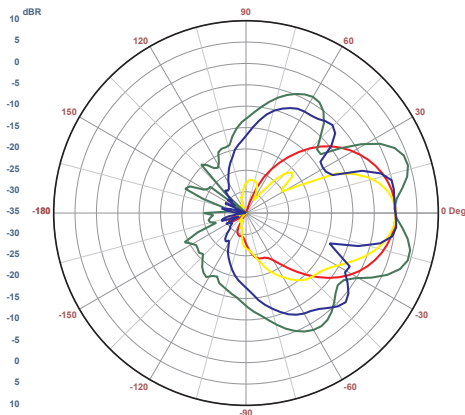

Curve	Freq	BW	Q	DI
Red	4.00K	55	6.6	8.2
Yellow	5.00K	36	9.9	10.0
Green	6.30K	62	5.8	7.7
Blue	8.00K	29	12.4	10.9

RATIO vs ANGLE

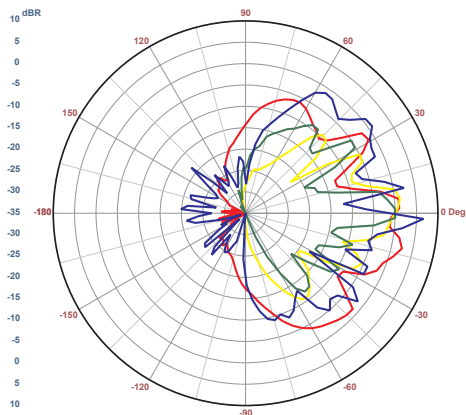

Curve	Freq	BW	Q	DI
Red	10.00K	36	9.9	10.0
Yellow	12.50K	25	14.1	11.5
Green	16.00K	15	24.8	13.9
Blue	20.00K	4	99.0	20.0

Polar Plots (1/3 Octave)

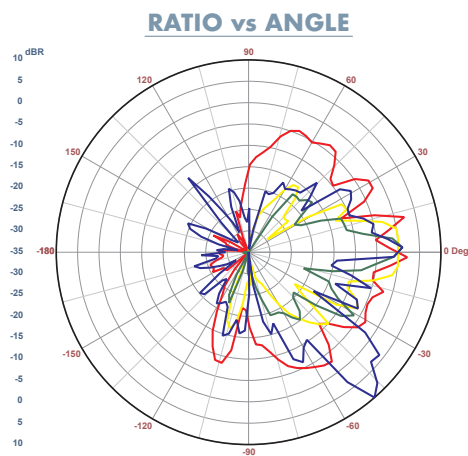
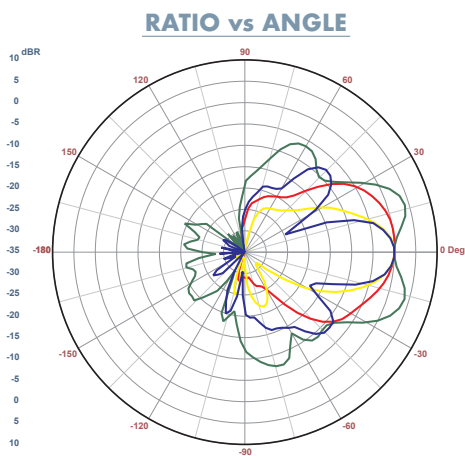
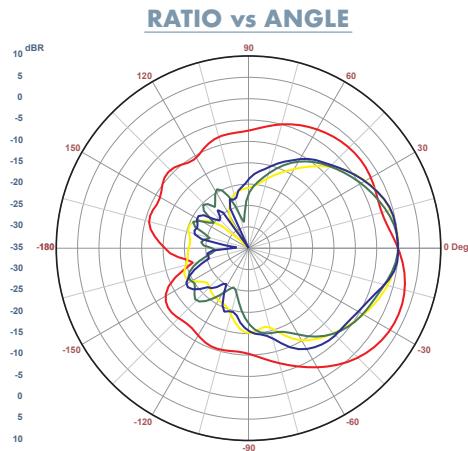
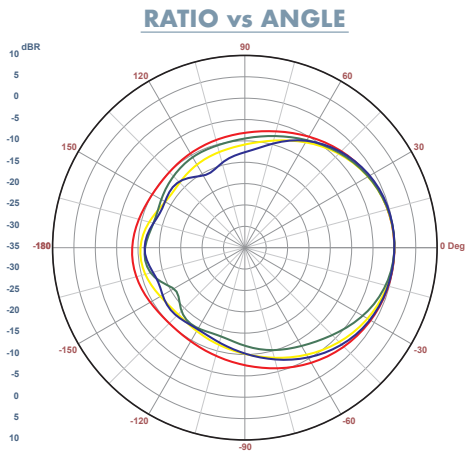
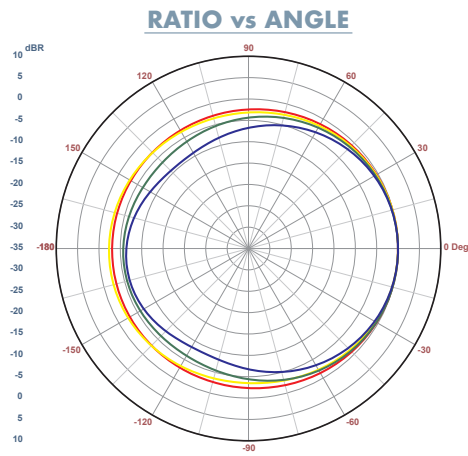
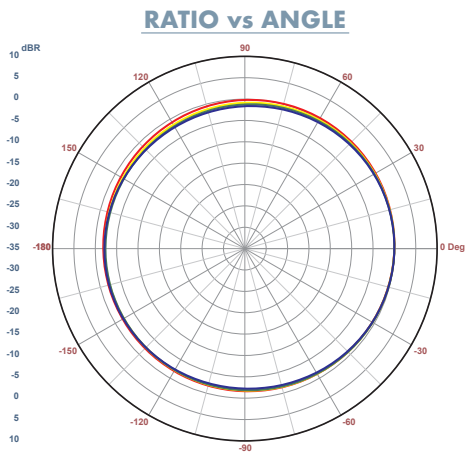

Dimensional Sketches Specifications

PS-S83WT Loudspeaker

Height: 14.02" (356mm)
 Width: 9.01" (229mm)
 Depth: 8.58" (218mm)

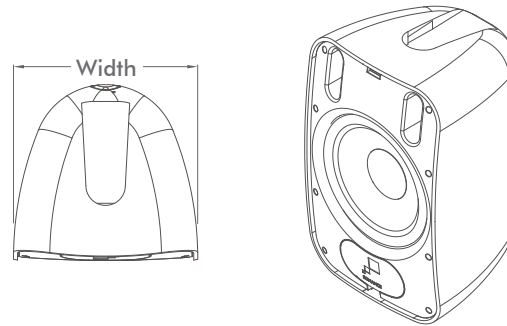
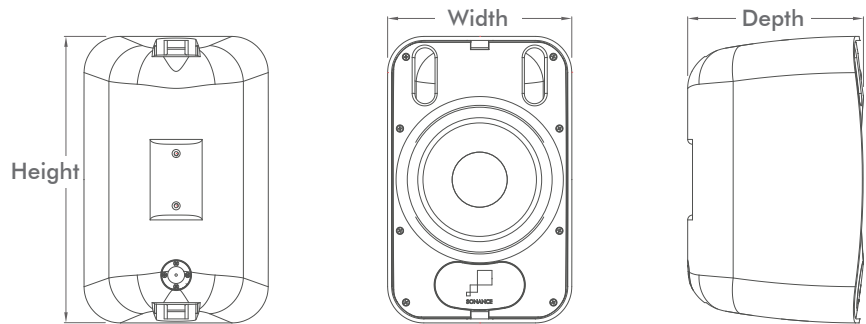

S8 Mounting Bracket

Height: 14.528" (369mm)
 Width: 4.527" (115mm)
 Depth
 Wall Mount: 9.37" (238mm)
 Depth
 Ceiling Mount: 10.315" (262mm)

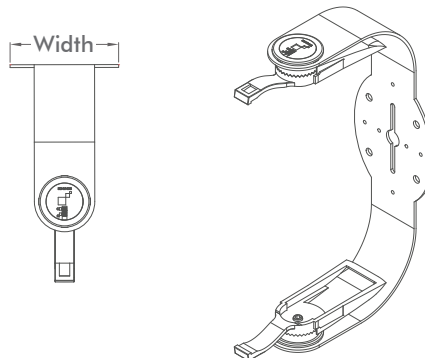
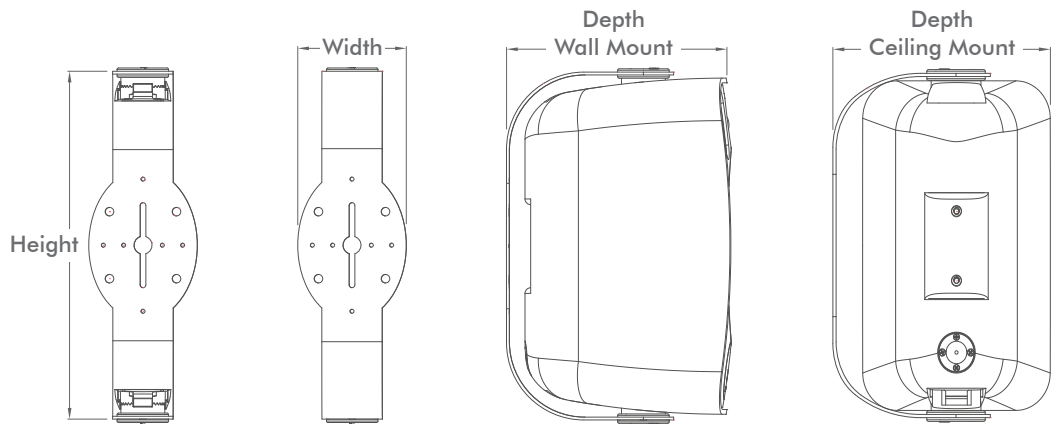

Architectural Specifications

The loudspeaker shall be of the two-way type comprising a single surface-mount injection-molded ABS enclosure containing one 8" (203mm) polypropylene cone, butyl rubber surround, ultra-high excursion low frequency transducer. It shall utilize a powder coated corrosion-resistant aluminum grille with friction-fit. Frequency range shall be 50Hz – 150Hz (-3dB). Total power handling shall be 125 Watts continuous pink noise and 200 Watts program. Sensitivity measured with 2.83 volts input at 1 meter on axis averaged between 50Hz – 150Hz shall be 88dB. The unit shall be supplied with a line-matching transformer suitable for 100 volt or 70 volt with a front-mounted control allowing user selectable power taps of 120W, 60W, 30W, and 15W (70V) and an 8 Ohm bypass. The speaker shall include a FastMount bracket that allows for a full 180° of pivot while keeping the speaker less than

1" from the mounting surface. Wire shall be terminated on the front of the enclosure via a four-pin Euroblock connector with loop-through and fed through a Protected Access Connection Terminal. The system shall be certified for UL 1480 (UEAY) and UL 2239 and conform to MIL-STD-810 for humidity, salt spray, temperature and UV IEC 529 and meet or exceed an IPX4 splash proof rating. External dimensions shall be 14.02" Height x 9.01" Width x 8.58" Depth (356mm x 229mm x 218mm). The total enclosure shall weigh 12 lbs. (5.44 kg) per unit. It shall share consistent voicing with other form factors and sizes within its product family so as to provide continuity of sonic signature when combined within a project. The loudspeaker shall be the Sonance Professional Series PS-S83WT. No other system shall be acceptable unless the above combined performance specifications are equaled or exceeded.

Safety Agency Compliance

Sonance Professional Series In-Ceiling Speaker are compliant with:

UL 1480 (UEAY): Standard For Safety For Speakers for Fire Alarm, Emergency, and Commercial and Professional Use.

NFPA 70: 2002 National Electrical Code

ENVIRONMENTAL AND UV: Conforms to Mil Spec 810 for humidity, salt spray, temperature, IEC 529 IP-X4 splash-proof rating.



Warranty, Remedy, Exclusions and Limitations (USA only)

Limited Warranty

Sonance warrants this product to the original purchaser to be free from defects in material and workmanship, under normal use and conditions, for a period of five (5) years from the date of original purchase as shown on the invoice.

The foregoing exclusive warranty gives you specific legal rights, and you may have other rights, which vary from state to state. This warranty applies exclusively to the original purchaser.

The exclusive warranty does not apply and is ineffective if:

1. The invoice fails to establish that the product was purchased from an authorized Sonance dealer or distributor;
2. The product was subjected to misuse, neglect, accident, or improper installation. (Damage to the product was caused by accident, abuse or misuse);
3. The product was modified, altered, or repaired by unauthorized personnel; or
4. The unit was not used as described in the installation and operating instructions.

Exclusive Remedy

Sonance agrees, at its option during the five (5) year warranty period, to repair any defect in material or workmanship or to furnish an equal product in exchange without charge to the purchaser, subject to the verification of the defect and proof of the date of purchase.

Warranty Exclusions and Damage Limitations

The exclusive warranty set forth above is in lieu of all other warranties, express or implied, including without limitation the implied warranties of merchantability and fitness for a particular purpose, which are expressly disclaimed. In no event, and under no circumstances or legal or equitable theory, shall Sonance be liable or responsible for any direct or indirect damages, consequential damages, loss, or injury, including without limitation, personal injury, bodily injury, property damage, emotional distress, death, real property or personal property damage, business interruption, costs of delay or lost profits arising from the product, whether based upon warranty, contract, negligence, strict product liability or other theory.

Associated Products

In-Ceiling Speakers

PS-C43RT In-Ceiling Speaker	40130
PS-C63RT In-Ceiling Speaker	40131
PS-C83RT In-Ceiling Speaker	40132
PS-C83RWT In-Ceiling Speaker	40133

Pendant Speakers

PS-P43T Pendant Speaker White	40134
PS-P63T Pendant Speaker White	40135
PS-P83T Pendant Speaker White	40136
PS-P83WT Pendant Speaker White	40137
PS-P43T Pendant Speaker Black	40138
PS-P63T Pendant Speaker Black	40139
PS-P83T Pendant Speaker Black	40140
PS-P83WT Pendant Speaker Black	40141

Surface Mount Speakers

PS-S43T Surface Mount Speaker White	40142
PS-S53T Surface Mount Speaker White	40143
PS-S63T Surface Mount Speaker White	40144
PS-S83T Surface Mount Speaker White	40145
PS-S43T Surface Mount Speaker Black	40147
PS-S53T Surface Mount Speaker Black	40148
PS-S63T Surface Mount Speaker Black	40149
PS-S83T Surface Mount Speaker Black	40150

DSP Amplifier

Sonamp DSP 2-750 Amplifier	93095
----------------------------	-------



©2017 Sonance. All rights reserved.
Sonance is a registered trademark of Dana Innovations.

Due to continuous product improvement, all features and specifications are subject to change without notice.
For the latest Sonance product specification information visit our website: www.sonance.com

SONANCE • 991 Calle Amanecer • San Clemente, CA 92673 USA
(949) 492-7777 • FAX: (949) 361-5151 • Technical Support: (949) 492-7777
www.sonance.com/professionalseries

02.22.18