

R-SERIES

UNPARALLELED MUSICALITY • SUPERIOR VOICE PROJECTION
LEGENDARY WEATHER-RESISTANCE

Community[®]



R-SERIES

THE UNDISPUTED CHOICE
OF AUDIO PROFESSIONALS WORLDWIDE

COMMUNITY FORGED A NEW PARADIGM FOR OUTDOOR LOUDSPEAKER PERFORMANCE OVER 15 YEARS AGO WITH THE INTRODUCTION OF THE R-SERIES. BY OFFERING FULL BANDWIDTH, HIGH OUTPUT VOICE AND MUSIC PROJECTION SYSTEMS FOR ANY SIZE OUTDOOR FACILITY, R-SERIES FREED SYSTEMS DESIGNERS AND VENUE OWNERS FROM THE LIMITATIONS ESTABLISHED PREVIOUSLY BY VOICE-ONLY SYSTEMS.

RAISING THE BAR

Since its beginning, R-Series has defined the performance standards of outdoor systems and satisfied the desire for "indoor quality sound" in outdoor installations. While R-Series raised the bar to make any system without high output, full bandwidth performance simply unacceptable, Community has continued to challenge the current standard by developing new outdoor technologies, and expanding the R-Series family over the years. Each generation of R-Series has added new solutions and improved upon past performance to exceed the ever higher expectations of audiences, venue operators, and systems designers.

NEXT GENERATION

The R-Series family now includes next-generation models which improve upon its legendary vocal intelligibility and music performance standards. In addition to providing new form factors, output levels, and even greater musical performance, Community has engineered better solutions to improve the already legendary weather-resistance, durability and sound quality of its enclosures and components. This new generation of R-Series loudspeakers complements the existing lineup by adding models that exhibit flatter passive frequency response, improved low frequency extension and higher output from the same footprint. Additional dispersion patterns, new input and cabling choices, built-in voicing options, and more attractive architectural enclosures are offered. Also available are premium performance, no-compromise versions of the most popular models, adding entirely new dimensions to the types of applications that can be served using R-Series loudspeakers.

PATTERN CONTROL

While R-Series products provide exceptional durability and protection outdoors, they are often the best choice for indoor applications as well. Most R-Series models utilize all horn-loaded designs, providing very high efficiency and output for all of the drivers, including the woofer(s). Horn-loading provides excellent pattern control in the lower frequencies, unlike traditional front-loaded woofer design loudspeakers. The pattern control provided by horn-loading makes R-Series the perfect choice for many indoor environments with difficult acoustic conditions, like long reverberation times or room geometries that cause a build-up of excess LF sound energy. In addition, many of the new next-generation R-Series models have been voiced specifically for premium music reproduction as its primary design goal, making them ideally suited for indoor music system applications.

APPLICATION DIVERSITY

As expectations of indoor and outdoor loudspeaker systems change, R-Series is continually evolving; building and improving upon its strengths, to provide the broadest variety of solutions available for nearly any application. The R-Series family now includes 31 models with multiple horn patterns, color choices and configure-to-order options. Ranging from shorter projection loudspeakers with wide coverage angles, to narrow dispersion, very long projection systems, the uses and applications of R-Series loudspeakers, singularly and in combination, is nearly unlimited, making the task of designing an acoustically effective sound system as easy as possible.

R-SERIES

12 FULL-RANGE MODELS, 3 SUBWOOFERS

31 OUTPUT, DISPERSION AND SIZE OPTIONS

UNMATCHED PROJECTION, CONTROL AND CLARITY



R6-51

PREMIUM MUSIC SOLUTIONS

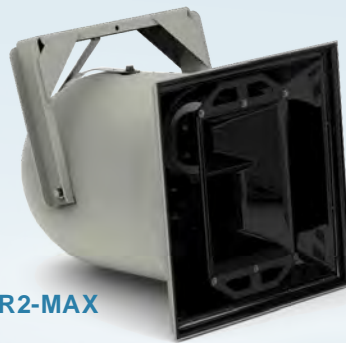

R2-MAX



R.5-MAX



R.35-3896



R.5COAX

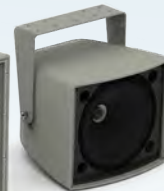

R.35COAX



R.15COAX

VOICE AND MUSIC SOLUTIONS

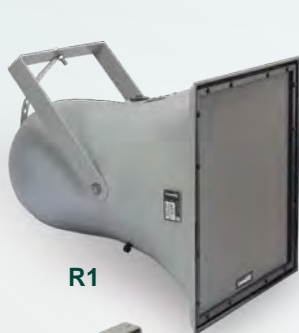

R1



R2



R.5HP



R.25



R.5

PAGING



RMG-200

RSH-462

| Models | Size | Projection Distance ¹ | Continuous Output (dB SPL) (Highest Representative Output) | Dispersion Patterns (HxV) | 2-Way | 3-Way | LF Pattern Control | Premium Vocal Intelligibility | LF Driver | MF Driver | HF Driver - Exit (Model) | Autoformer/Transformer | Enclosure |
|--------|------|----------------------------------|---|---------------------------|-------|-------|--------------------|-------------------------------|-----------|-----------|--------------------------|------------------------|-----------|
|--------|------|----------------------------------|---|---------------------------|-------|-------|--------------------|-------------------------------|-----------|-----------|--------------------------|------------------------|-----------|

| PREMIUM MUSIC SOLUTIONS | R.15COAX⁵ | Micro | S | 117 | 100° x 100° | ● | | ● | 6.5" | | 1.25" (CX254) | Included Autoformer | Paintable ABS |
|-------------------------|----------------------------------|---------------|-------|-----|-------------------------------------|---|---|---|-------------------------|---------------------|------------------|---------------------|--------------------|
| | R.35COAX⁵ | Ultra-Compact | S | 122 | 90° x 90° | ● | | ● | 10" | | 1.25" (CX254) | Included Autoformer | Paintable ABS |
| | R.35-3896⁵ | Ultra-Compact | S/M | 126 | 90° x 60° | | ● | ● | 8" HP ³ | 2 x CM2040 | 1" (CD254) | Included Autoformer | Paintable ABS |
| | R.5COAX | Compact | S | 119 | 60° x 60° 90° x 90° | ● | | ● | 12" | | 1" (UC1) | Optional | LLDPE ⁴ |
| | R.5-MAX | Compact | S/M/L | 131 | 60° x 60° 90° x 60° | ● | | ● | 12" HP ³ | | 1.4" | Accessory | LLDPE ⁴ |
| | R2-MAX (Biamp) | Large | M/L | 133 | 60° x 40° 60° x 60° 90° x 40° | | ● | ● | 2 x 12" HP ³ | M200HP ³ | 1.4" | N/A | Fiberglass |
| | R6-51⁶ (Biamp) | X-Large | VL | 138 | 50° x 10° | | ● | ● | 6 x 12" | M200 | 6 x 1" (HFE2) | N/A | Fiberglass |

| VOICE AND MUSIC SOLUTIONS | R.25-94 | Ultra-Compact | S | 120 | 90° x 40° | ● | | ● | 8" | | 0.75" (HF20) | Optional | LLDPE ⁴ |
|---------------------------|------------------------|---------------|-----|-----|---|---|---|---|---------|---------|-----------------|-----------|--------------------|
| | R.5 | Compact | S/M | 126 | 60° x 60° 90° x 40° 90° x 90° | ● | | ● | 12" | | 1" (UC1) | Optional | LLDPE ⁴ |
| | R.5HP (R.5HP-R) | Compact | M/L | 129 | 60° x 40° (15° uptilt) | | ● | ● | 12" | M200 | 1" (UC1) | Optional | LLDPE ⁴ |
| | R1 | Large | M/L | 128 | 60° x 40° 60° x 60° 90° x 40° | ● | | ● | 12" | | 1" (HFE2) | Accessory | Fiberglass |
| | R2⁶ | Large | L | 130 | 70° x 70° 90° x 40° 90° x 40° AS ² | | ● | ● | 2 x 12" | M200 | 1" (HFE2) | Accessory | Fiberglass |
| | | Large | L | 133 | 50° x 20° | | ● | ● | 2 x 12" | 2x M200 | 1" (HFE2) | Accessory | Fiberglass |

| PAGING | RMG-200 | Compact | L | 134 | 50° x 40° | | | ● | | M200 | | Optional | Fiberglass |
|--------|----------------|---------|----|-----|-----------|--|--|---|--|----------|--|-----------|------------|
| | RSH-462 | Large | VL | 143 | 60° x 20° | | | ● | | 4 x M200 | | Accessory | Fiberglass |

¹ S = Short; M = Medium; L = Long; VL = Very Long

² "AS" = "Asymmetrical"; horizontal pattern is 30 degrees narrower at the top of the horn than at the bottom (value stated).

³ "HP" = "High Performance" driver

⁴ "LLDPE" = Linear low density polyethylene plastic, not suitable for painting in outdoor environments.

⁵ R.15 and R.35 models feature terminal strip and NL4 inputs, plus a "Voice/Music" switch. All other models feature 12 ft. (3.6m) 16-2 gauge SJOW input cables.

⁶ 4 ohm systems, all other models are 8 ohm.

For a complete list of technical specifications for each model, please visit the Community website: www.communitypro.com

PREMIUM MUSIC SOLUTIONS

R.35-3896

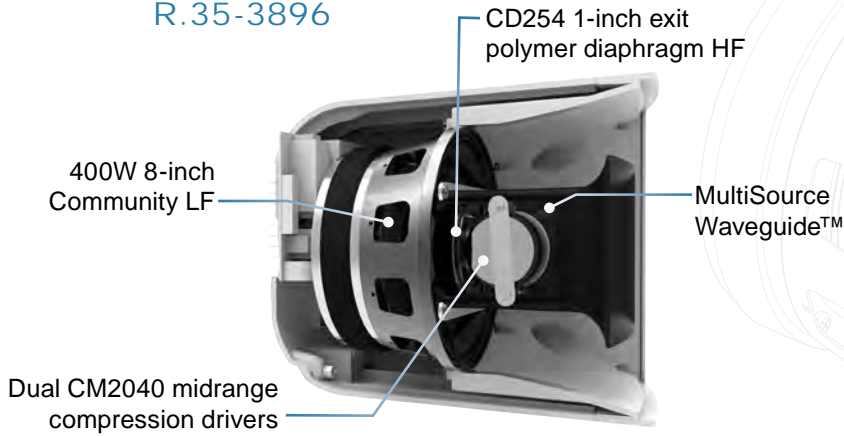

R.5-MAX

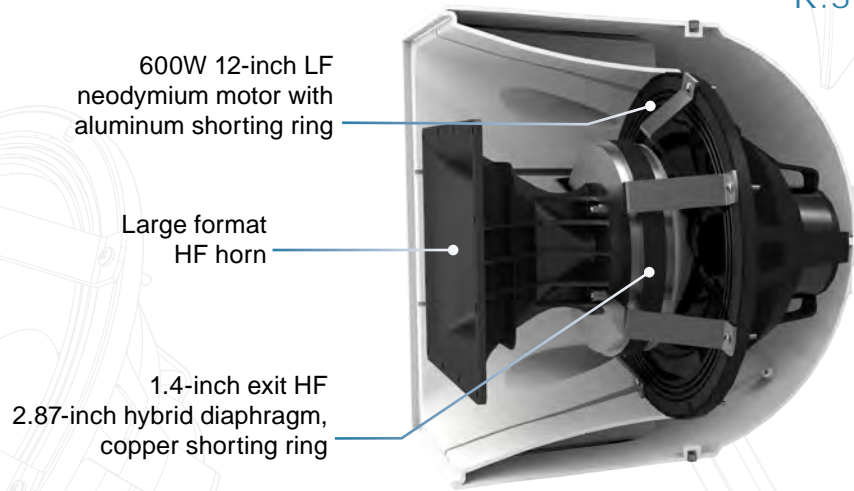

R2-MAX

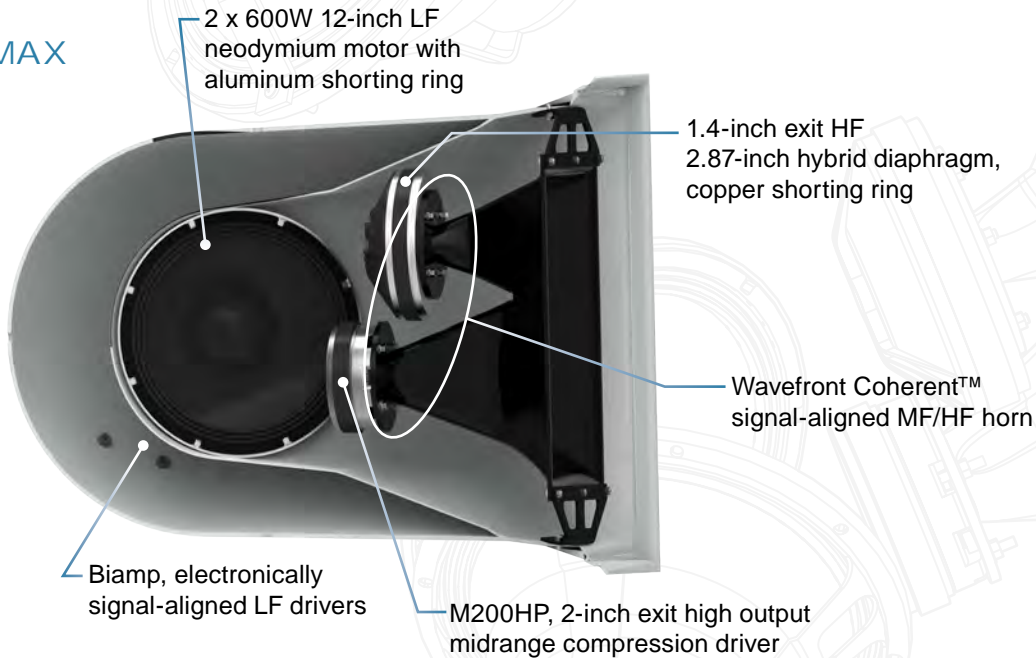

ENGINEERED PERFORMANCE

APPLICATION VERSATILITY

Everything you love about R-Series taken to the next level.

Designed to transcend the increasing performance expectations of audiences in contemporary venues, each model effortlessly delivers exceptionally high quality music reproduction in addition to providing the unsurpassed speech intelligibility and projection you expect from R-Series.

This is R-Series without compromise.

With extended flat frequency responses, signal-aligned premium transducers, a diverse range of model sizes, and some of the highest output levels in R-Series, these loudspeakers expand R-Series application possibilities into new dimensions.

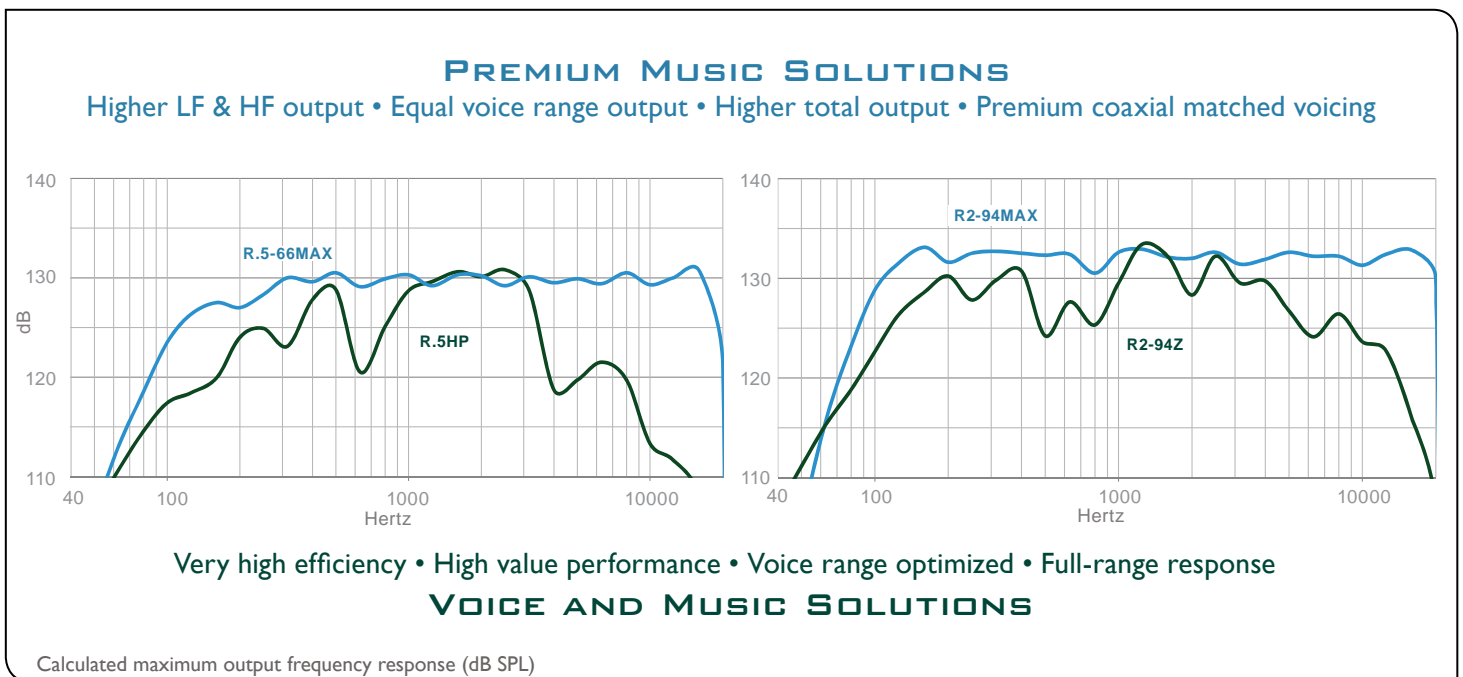

PREMIUM COAXIAL MATCHED VOICING



R.15COAX

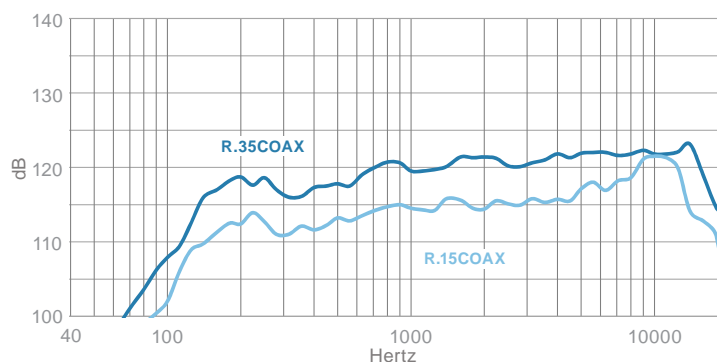

R.35COAX



PREMIUM MUSIC SOLUTIONS

R.15COAX 6.5-INCH FRONT-LOADED 2-WAY



Outstanding full-range music reproduction in a remarkably small enclosure. The large HF compression driver provides low distortion, high headroom and a very flat frequency response that requires no EQ. The sealed LF enclosure produces studio quality, non-resonant low frequency reproduction and the low 1.3 kHz crossover point ensures crisp, articulate music and voice reproduction. Its 100° x 100° conical dispersion is the widest in R-Series. The attractive, paintable ABS enclosure houses an included 120W autoformer and a Voice/Music response modification switch. *150W Cont., 94/195dB 1W/1m (Music/Voice Setting), 116/117 dB Max Output (Music/Voice setting), 8 ohms.*

☒ **Small Size, Big Performance**

☒ **Large HF Compression Driver**

R.35COAX 10-INCH FRONT-LOADED 2-WAY



Same outstanding voicing as the R.15COAX with deeper LF extension and up to 5dB higher output. The same large HF compression driver and low 1.3 kHz crossover point ensure identical flat, music-friendly voicing and crisp articulation in both models. The enclosure features extensive internal bracing, including weather-sealed 18mm wood inserts lining the walls to produce natural, uncolored bass and low-mid response. Features high output and 90° x 90° conical wide dispersion; an alternative to the R.25-94 or the larger R.5COAX. Attractive, paintable ABS enclosure houses an included 200W autoformer and Voice/Music switch. *200W Cont., 97/199 dB 1W/1m (Music/Voice Setting), 120/122 dB Max Output (Music/Voice Setting), 8 ohms.*

☒ **Flat Frequency Response**

☒ **Same High Output as R.25 and R.5COAX**

R.5COAX 12-INCH FRONT-LOADED 2-WAY



The largest member of the coaxial series, this loudspeaker features the same high sensitivity and high output as the R.35COAX, but with even greater LF extension. Community's exclusive LF driver and 1-inch exit horn-loaded compression driver produce a wide range, smooth musical frequency response with superb projection. The heavy wall, reinforced enclosure provides uncolored music reproduction and the best LF extension of all R-Series coaxial models. Available with a 90° x 90° dispersion pattern or the tighter 60° x 60° pattern for high ceiling or challenging acoustics applications. Internal 200W autoformer available. *200W Cont., 96/98 dB 1W/1m, 119/121 dB Max Output, 8 ohms.*

☒ **Excellent LF Extension**

☒ **Multiple Horn Patterns**

R.35-3896 8-INCH HIGH PERFORMANCE, HIGH OUTPUT HORN-LOADED 3-WAY



The innovative triaxial design delivers musical quality and detail better than many larger loudspeakers. Community's exclusive MultiSource Waveguide™ sums dual midrange compression drivers and a 1-inch exit HF driver into a single point source with a 90° x 60° dispersion pattern. Designed for premium quality music reproduction with exceptional clarity. Excellent choice for sightline-friendly, medium-projection sports venue music systems as a flatter, higher output alternative to R.25. Attractive, paintable ABS enclosure with included 200W autoformer and Voice/Music switch. *400W Cont., 98/100 dB 1W/1m (Music/Voice Setting), 124/126 dB Max Output (Music/Voice Setting), 8 ohms.*

☒ **MultiSource Waveguide™**

☒ **Stunning Music Quality and Vocal Clarity**

116-117 dB

120-122 dB

119-121 dB

124-126 dB

MAXIMUM CONTINUOUS OUTPUT AT 1 METER

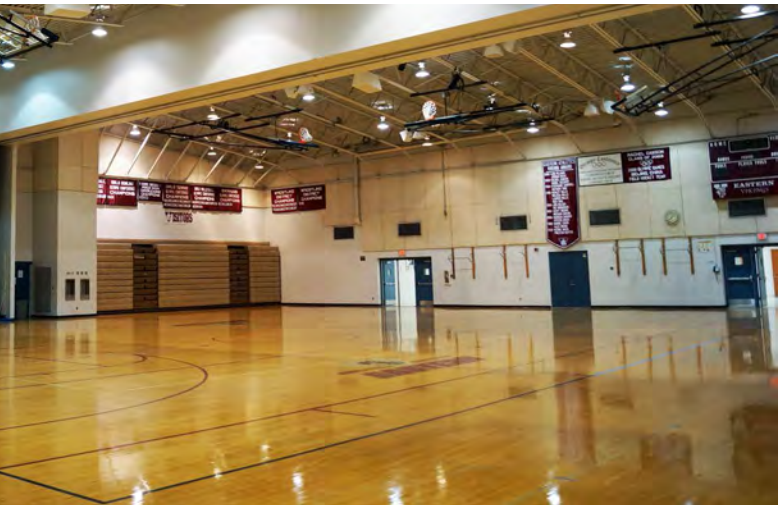
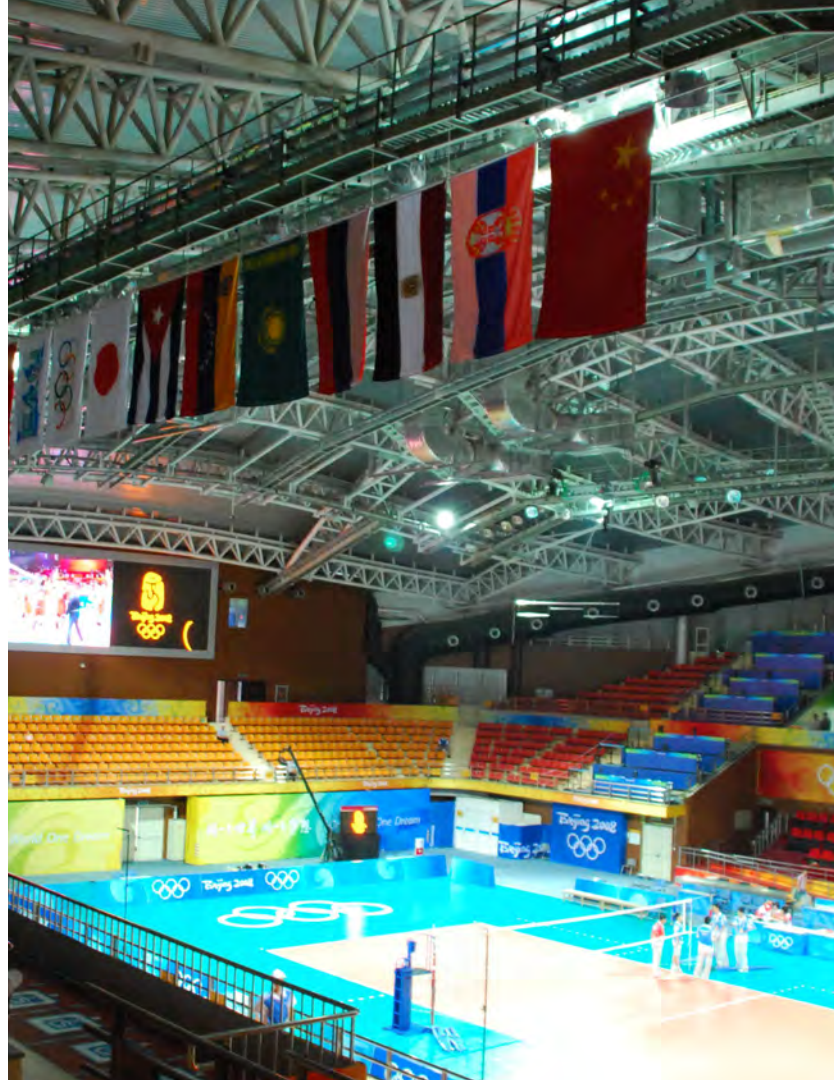

PREMIUM MUSIC SOLUTIONS

R.5-MAX 12-INCH PREMIUM PERFORMANCE, HIGH OUTPUT HORN-LOADED 2-WAY



Small size with large performance. Highest output full-range compact loudspeaker available. Delivers the same high output levels as many standard R2 models and exceeds the output of all R1 models while producing a flat, musical frequency response with exceptional dynamic range and detail. Large format, low distortion transducers ensure premium sound quality in any application, whether up close at poolside, or projecting long distances in world-class stadiums. True point source operation with passive crossover, available with 90°x60° or 60°x60° dispersion for challenging indoor acoustics or longer projection outdoor applications. 600W Cont., 102/103dB 1W/1m, 130/131dB Max Output, 8 ohms.

- ☒ **Very Flat Frequency Response**
- ☒ **Higher Output than R1 and R.5HP**

R2-MAX 2 x 12-INCH PREMIUM PERFORMANCE, HIGH OUTPUT HORN-LOADED 3-WAY



Legendary R2 pattern control and projection, with substantially upgraded acoustic performance. Precision engineered for premium music reproduction. Customized high output, large format HF and LF drivers are paired with Community's redesigned M200HP midrange compression driver and a large, signal-aligned, Wavefront Coherent™ MF/HF horn to produce the flattest frequency response and highest broadband output ever in an R2. Additionally, the dual neodymium LF drivers are electronically signal-aligned with the MF/HF horn, ensuring true point source performance and outstanding transient response behavior. Premium drivers and all-horn-loading results in extremely low distortion, exceptional dynamic range, unmatched vocal clarity and stunning musical detail with up to 3dB higher output than standard R2s. World-class performance for large stadiums, themed entertainment, or permanent music reinforcement applications outdoor or indoor. Three available dispersion patterns, 60°x40°, 60°x60° or 90°x40°. 1200W Cont., 103dB 1W/1m, 132/133dB Max Out., 8 ohms, Biamp.

- ☒ **Wavefront Coherent™ Alignment**
- ☒ **Flatter Response and Higher Output than R2**

R6-51 HIGH OUTPUT, HIGH POWER, 3-WAY MULTI-DRIVER VERTICAL ARRAY



The largest, highest output full-range R-Series model. Features six LF, MF and HF drivers in horn-loaded vertical arrays, designed to deliver a balanced, flat frequency response with a tightly controlled pattern for projection over very long distances. The large low frequency horn design generates exceptional LF extension and musical impact while reducing LF "spill" into surrounding areas by controlling directivity down to 200Hz. The passive Wavefront Coherent™ MF/HF horn is electronically signal-aligned with the LF drivers, resulting in excellent transient behavior and musical clarity. The exceptionally high sensitivity ensures detailed music reproduction with enormous dynamic range, very low distortion and up to 5dB higher output than an R2-MAX. Designed to deliver premium true point source performance in stadiums, end zone arrays and any other very long projection broadband music system. 1200W Cont., 109dB 1W/1m, 138dB Max Output., 4 ohms, Biamp.

- ☒ **Wavefront Coherent™ Alignment**
- ☒ **Highest Output R-Series Loudspeaker**

130-131dB

132-133dB

138dB

MAXIMUM CONTINUOUS OUTPUT AT 1 METER



VOICE AND MUSIC SOLUTIONS

R.25-94 8-INCH HORN-LOADED 2-WAY



Efficient vocal projection and directivity control. The horn-loaded LF driver delivers better low frequency pattern control, higher sensitivity, higher output, and better vocal projection than "typical" 8-inch two-way loudspeakers. The tight 40° HF vertical dispersion minimizes reflections, increasing vocal clarity over distance. Ideal for use in difficult acoustic environments requiring a small footprint, like stadium concourses and gymnasiums. Excellent supplemental reinforcement in larger R-Series systems at youth sports fields, community pools, or themed entertainment. Also may be used alone in smaller applications. Internal 200W autoformer available. 200W Cont., 97dB 1W/1m, 120dB Max Output, 8 ohms.

- ☒ **Compact Directivity Control**
- ☒ **Same High Output as R.35COAX and R.5COAX**

R.5 12-INCH HORN-LOADED 2-WAY



Excellent vocal projection and wideband directivity control. The large LF horn creates substantial pattern control, helping to reduce unwanted room reflections and improve vocal clarity in difficult acoustic environments. The large HF horn provides well-controlled midrange directivity and clear, articulate vocals. The high sensitivity, wide frequency response, and excellent projection capabilities over moderate distances make this loudspeaker ideal for many general purpose voice and music applications indoors or outdoors. Three available dispersion patterns: 60° x 60°, 90° x 40°, and 90° x 90°. Internal 200W autoformer available. 200W Cont., 101/103dB 1W/1m, 124/126dB Max Output, 8 ohms.

- ☒ **Full Bandwidth, Controlled Projection**
- ☒ **Same High Output as R.35-3896**

R1 12-INCH LARGE FORMAT HORN-LOADED 2-WAY



Very high sensitivity with LF directivity control to 400Hz. The large, deep LF horn and large diaphragm 1-inch exit HF driver provide greater HF extension and LF output than the R.5HP with similar voiceband output. Three available horn patterns, 60° x 40°, 60° x 60° or 90° x 40°, deliver excellent wideband directivity. A superb choice for excessively reverberant indoor sports venues and small to mid-sized outdoor stadiums. 200W Cont., 104/105dB 1W/1m, 127/128dB Max Output, 8 ohms.

- ☒ **Directivity Control to 400Hz**
- ☒ **Output similar to R.5MAX and R.5HP**

R.5HP 12-INCH HIGH OUTPUT VOICE BAND HORN-LOADED 3-WAY



Exceptionally high sensitivity, long projection compact loudspeaker. Maximizes vocal projection and intelligibility over distance by incorporating a Community M200 midrange compression driver on a coaxially mounted 60° x 40° horn, creating a focused directivity pattern with a pronounced response emphasis in the midrange voice band. The LF and HF contribute significantly to the response, resulting in effortless, realistic voice reproduction that is ideal for voice PA applications in stadiums, fair grounds, or auto racing tracks. Internal 200W autoformer available. 200W Cont., 106dB 1W/1m, 129dB Max Output, 8 ohms.

- ☒ **Voice Emphasized Focused Projection**
- ☒ **Higher Voiceband Output than R1**

R2 2 x 12-INCH LARGE FORMAT HORN-LOADED 3-WAY



Exceptional pattern control and vocal projection. Delivers very high sensitivity and very high output levels with LF directivity to 300Hz. Community's M200 midrange compression driver and the deep, low flare rate midrange horn produce legendary long distance vocal projection with exceptional vocal clarity and extremely low distortion. Wide bandwidth directivity control makes it the ideal choice for taming difficult acoustic environments or achieving precision coverage over long distances. Available in three symmetric (50° x 20°, 70° x 70° and 90° x 40°) and two asymmetric coverage patterns (40-70° x 40° and 60-90° x 40°). 400W Cont., 104-107dB 1W/1m, 130-133dB Max Output, 4 ohms.

- ☒ **Directivity Control to 300Hz**
- ☒ **Legendary Vocal Projection and Clarity**

120dB

124-126dB

127-128dB

129dB

130-133dB

MAXIMUM CONTINUOUS OUTPUT AT 1 METER



VOICE PROJECTION SOLUTIONS

PAGING AND EMERGENCY NOTIFICATION

RMG-200 VOICE RANGE ANNOUNCEMENT



Extremely efficient voice-range horn / driver system designed for long projection voice-range sound reinforcement, announcement and signaling applications. The 50° x 40° horn, driven by Community's M200 midrange compression driver, delivers focused, high-output sound projection from 400Hz to 8kHz with effortless vocal clarity and extremely low distortion. The rugged fiberglass construction and inherently weather resistant driver design ensure exceptional long-term durability and performance predictability. Includes a rotatable hot-dipped galvanized steel mounting bracket. Available with a 75W internal autoformer. *75W Cont., 115 dB 1W/1m, 134 dB Max Output, 11 ohms.*

RSH-462 EXPONENTIAL FOCUSEDARRAY™ HIGH LEVEL HORN SYSTEM



Community's highest efficiency, longest projection distance loudspeaker system. Designed for use in stand-alone voice-range sound reinforcement, announcement and signaling applications. Four inherently weather resistant M200 midrange compression drivers, mounted on Community's proprietary FocusedArray™ 60° x 20° exponential waveguide, provide extremely high-output sound reproduction from 400Hz to 8kHz with unrivaled vocal clarity and very low distortion. A robust, hot-dipped galvanized steel, locking mounting bracket is included. Ideal for very long projection voice and critical emergency warning notification systems. *300W Cont., 118 dB 1W/1m, 143 dB Max Output, 11 ohms.*

R.15COAX 6.5-INCH FRONT-LOADED 2-WAY

Provides a competitive value-added upgrade from low cost paging horns. Full-range performance, ideal for combined voice paging and background music systems.

- Small Size
- High Output
- 70V/100V Autoformer included



BASS AUGMENTATION SOLUTIONS

SUBWOOFERS

R.5SUB 12-INCH SUBWOOFER



Engineered to provide quality low frequency reproduction in a compact enclosure. It is sized identically to the other R.5s and can be flown or down-fired for flexible system configuration. It includes an internal low pass filter (120Hz, 12 dB/oct) and is available with an optional 200W internal transformer. It was designed to extend the low frequency response of small to mid-size R-Series systems at racetracks, sports venues, and in outdoor music systems. *200W Cont., 91 dB IW/1m, 114 dB Max Output, 6 ohms.*

R2SUB 2 x 12-INCH SUBWOOFER



R2SUBDF shown

High output low frequency reproduction in an R2 enclosure. Available in two versions, the standard R2SUB includes a rotatable mounting yoke. The R2SUBDF down-firing version includes four corner mounting brackets and has a vandal-resistant cable cover for protection from abrasion or tampering. It provides a higher output with better LF extension than the R.5SUB. Use the R2SUB to extend the low frequency response of any medium to large R-Series system; at racetracks, music amphitheaters, or outdoor sports venues. *400W Cont., 92/95 dB IW/1m, 118/121 dB Max Output, 4 ohms.*

R6-BASSHORN 6 x 12-INCH HORN-LOADED LF SYSTEM



The best choice for stadium and arena systems. Provides exceptionally high sensitivity, very high output low frequency extension for large, long projection systems. Sized identically to R6-51, it can be vertically or horizontally arrayed with either an R6-51 or additional R6-Basshorns for increased LF output, extension, and pattern control. It is ideal for augmenting the LF extension in outdoor stadiums and permanent outdoor music systems with R2, R2-MAX and R6-51 systems. *1200W Cont., 108 dB IW/1m, 139 dB Max Output, 4 ohms.*



HIGH PERFORMANCE BY DESIGN

MULTISOURCE WAVEGUIDE™

Dual midrange compression drivers and a 1-inch exit HF driver are summed into a coherent, signal-aligned point source. This innovative compact design produces the high output and low crossover point of a large diaphragm HF compression driver, but with lower distortion and superior transient response behavior.

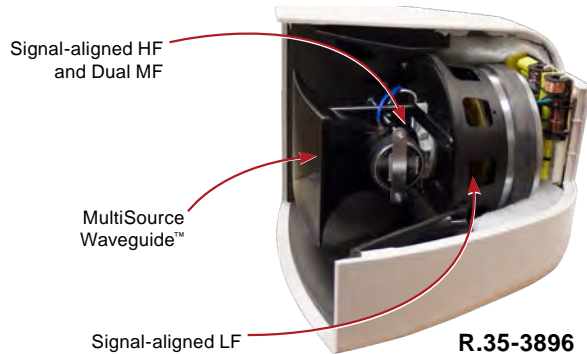

LOW FREQUENCY PATTERN CONTROL

Community understands that horns not only improve driver efficiency, but they also provide better low frequency pattern control in smaller enclosures than typical direct radiator designs. LF pattern control greatly increases intelligibility in indoor applications with difficult acoustics and helps maintain consistent voicing over distance in longer projection outdoor systems. R-Series includes larger models with control to 200Hz and compact models with control to 600Hz.

DYNA-TECH™ DRIVER PROTECTION CIRCUITRY

Using only the power of the amplifier, DYNA-TECH™ guards against transducer overdrive by instantaneously and dynamically reducing power to the system in a multi-stage approach that progressively dissipates the amplifier's output until it triggers a temporary shutdown. Full output is immediately restored by reducing drive levels to be within specified limits.

TRUE POINT SOURCE PERFORMANCE

Whether a coaxial direct radiator model with excellent low frequency extension or an all horn-loaded model with superior low frequency pattern control, all R-Series models share one common characteristic. Every R-Series loudspeaker features True Point Source performance, delivering a single, unified apparent source. The True Point Source arrangement provides realism, naturalness and superior localization of the sound. The coaxial and triaxial designs also eliminate any off-axis side-lobes that are typically created by non-point source arrangements.

SIGNAL-ALIGNED TRANSDUCERS

Traditional loudspeakers feature a front-loaded LF with the MF/HF on deep horns. The distance between the various drivers causes significant signal arrival time delay differences at the listener's ears and additional problems at passive crossover points. Nearly all R-Series loudspeakers place the MF/HF as close as possible to the LF drivers, providing noticeably improved time coherence and crossover linearity.



MULTIPLE OPTIONS

CONFIGURE-TO-ORDER (CTO) OPTIONS*

All R1, R2, and R2-MAX models are available with various standard Configure-to-Order options that can be added when required.

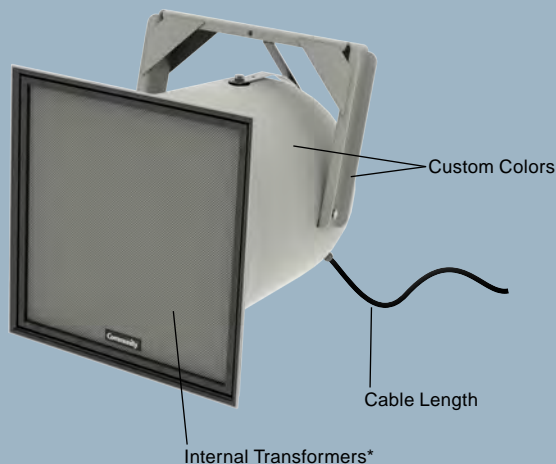

**Some options not available on all products*

STANDARD COLORS

All compact, ultra-compact, and micro size R-Series products (R.15 through R.5-MAX) are available in standard black, white and grey finishes at no additional charge. All larger R-Series loudspeakers are available in a grey finish. All standard color models include a color-matched grille and mounting yoke.



INCLUDED MOUNTING BRACKETS

All R-Series loudspeakers, except R6 models, are shipped with color-matched U-shaped yoke brackets for mounting the loudspeakers with rotational aiming on one axis. Many of the loudspeakers allow the bracket to be rotated on the enclosure 90° to accommodate the modification of dispersion pattern direction.

ADVANCED WEATHER-RESISTANCE

WEATHER-STOP™ GRILLES

Community pioneered the design and use of Weather-Stop™ Grille in the first R2 loudspeakers in 1998. Since then, we have continually refined the design using the latest materials and technologies available, to enhance performance and reliability. We have again become the first to introduce a number of innovative improvements to our original design, including dual-layer powder-coat (DLPC) technology, UV-resistant synthetic cloth mesh and most recently, NeverWet™.

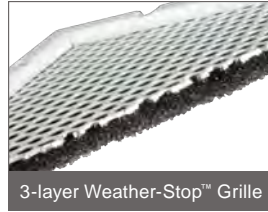

3-layer Weather-Stop™ Grille

ENVIROTECH™ COATINGS

All internal circuitry is protected from the elements with our proprietary Envirotech™ coating. Envirotech™ seals sensitive electronic components against the effects of moisture and corrosive or acidic airborne contaminants.

INNOVATIVE ENCLOSURE DESIGNS

Each new generation of R-Series loudspeakers brings evolutionary improvements in enclosure materials and techniques to provide the ultimate in outdoor weather-resistance, long-term durability, and audio performance. The largest R-Series loudspeakers use sealed, resonance-free, hand-laminated fiberglass enclosures. R.25 and R.5 models feature a lighter weight one-piece, internally reinforced, rigid linear low density polyethylene (LLDPE) plastic enclosures with outstanding resistance to temperatures and ultraviolet exposure. R.15 and R.35 models feature UV-treated, epoxy-joined, paintable high-impact ABS enclosures with extensive internal reinforcement for the best possible weather-resistance, sound reproduction, and application flexibility. All R-Series loudspeakers include a 15 year enclosure warranty.

NEVERWET™ *

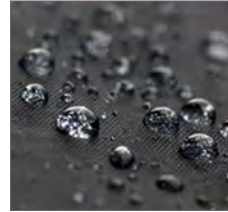

NeverWet™ is a superhydrophobic nano-technology coating that repels water at angles up to 170°. Community is the first loudspeaker manufacturer in the world using this technology. We apply NeverWet™ to all grilles and woofers in the R.15 and R.35 loudspeakers for superior protection from water ingress and driver damage.

* NeverWet is a registered trademark of NeverWet, LLC.

DUAL-LAYER POWDER-COAT

The steel grilles and yokes of all R-Series loudspeakers are treated with Community's proprietary dual-layer powder-coating process.

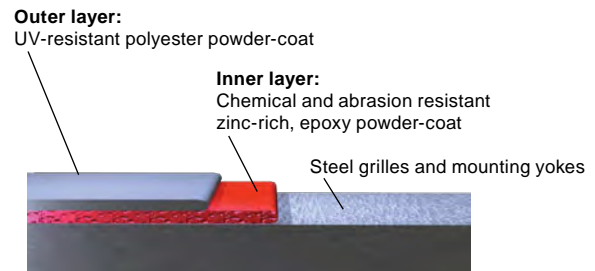

An inner layer of a zinc-rich epoxy powder-coat and an outer layer of a UV-resistant polyester powder-coat provide two layers of protection against abrasion and corrosion. The combination of epoxy and polyester powder-coats provides optimal protection for all circumstances and installations. Independent tests performed by the U.S. military and NASA demonstrated that a zinc-rich epoxy inner layer and a UV-protected outer color layer produced the best and longest lasting method of protecting steel structures from corrosion, pitting or other damage, and in many applications was superior to untreated 304SS for protection against performance and aesthetic degradation.

STANDARD ACCESSORIES



PMB-1RR
Pole Mount Bracket for a single loudspeaker; accommodates up to 90° of aiming down-tilt. Can also be used as an independent safety cable mounting point for any compact, or smaller, R-Series loudspeaker.



PMB-2RR
Pole Mount Bracket for single or dual loudspeakers. Features vertical down-tilt and left-to-right panning for each loudspeaker.

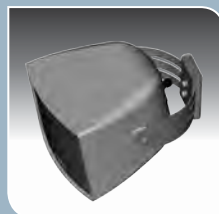

R-VTY15/35
Pan and tilt yoke system for R.15 and R.35 loudspeakers. Allows pan and tilt aiming of R.15 or R.35 loudspeaker while mounted to a solid surface.

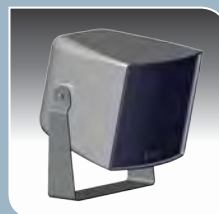

R-FRY35
Full rotation, wide stance yoke for all R.35 model loudspeakers that allows significant downward aiming of R.35 loudspeakers when the yoke is mounted beneath the enclosure.

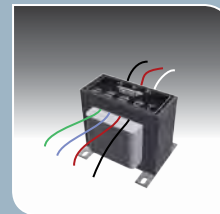

TRC400-8
External 400W transformer for use 8 ohm loudspeakers. Wattage taps of 400W/200W/100W @ 70V input, or 400W/200W @ 100V input. Recommended for use with all R.5-MAX models and the R.35-3896. TRC400, 4 ohm model also available.



DSPEC
A proprietary Digital Signal Processor developed to make the design and commissioning of Community Loudspeaker Systems fast and easy. Minimal setup and commissioning time.

MAXIMUM CONTINUOUS OUTPUT¹

| | | Model | Max dB SPL at 1m | 112 | 114 | 116 | 118 | 120 | 122 | 124 | |
|--------------------------------|--|-----------------------------------|------------------|-----|-----|-----|-----|-----|-----|-----|--|
| PREMIUM MUSIC SOLUTIONS | | R.15COAX ² | 116 / 117 | | | | | | | | |
| | | R.5COAX99 | 119 / 119 | | | | | | | | |
| | | R.35COAX ² | 120 / 122 | | | | | | | | |
| | | R.5COAX66 | 121 / 120 | | | | | | | | |
| | | R.35-3896 ² (70V-100V) | 121 / 123 | | | | | | | | |
| | | R.35-3896 ² (8Ω) | 124 / 126 | | | | | | | | |
| | | R.5-96MAX ³ | 129 / 130 | | | | | | | | |
| | | R.5-66MAX ³ | 130 / 131 | | | | | | | | |
| | | R2-94MAX ³ | 131 / 132 | | | | | | | | |
| | | R2-64MAX ³ | 132 / 133 | | | | | | | | |
| | | R2-66MAX ³ | 132 / 133 | | | | | | | | |
| | | R6-51 BIAMP ³ | 138 / 141 | | | | | | | | |

| | | | | | | | | | | | |
|----------------------------------|--|------------------|-----------|--|--|--|--|--|--|--|--|
| VOICE AND MUSIC SOLUTIONS | | R.25-94Z | 120 / 120 | | | | | | | | |
| | | R.5-99Z | 124 / 124 | | | | | | | | |
| | | R.5-94Z | 124 / 125 | | | | | | | | |
| | | R.5-66Z | 126 / 126 | | | | | | | | |
| | | R1-94Z | 127 / 128 | | | | | | | | |
| | | R1-64Z / R1-66Z | 128 / 129 | | | | | | | | |
| | | R.5HP | 129 / 130 | | | | | | | | |
| | | R2-77Z / R2-694Z | 130 / 131 | | | | | | | | |
| | | R2-94Z | 131 / 132 | | | | | | | | |
| | | R2-474Z | 132 / 133 | | | | | | | | |
| | | R2-52Z | 133 / 135 | | | | | | | | |

| | | | | | | | | | | | |
|----------------------|--|-------------|-----|--|--|--|--|--|--|--|--|
| PAGING / SUBS | | RMG-200 | 134 | | | | | | | | |
| | | RSH-462 | 143 | | | | | | | | |
| | | R.5SUB | 114 | | | | | | | | |
| | | R2SUB | 118 | | | | | | | | |
| | | R2SUBDF | 121 | | | | | | | | |
| | | R6-BASSHORN | 139 | | | | | | | | |

Premium Music and Vocal / Music Applications:

"Music-range" = Maximum continuous broadband output over stated spec sheet operating range.

"Voice-range" = Maximum continuous output over stated spec sheet "speech range", except where noted.

Paging / Subs:

"Voice Only Range" = Maximum continuous output over stated spec sheet operating range.

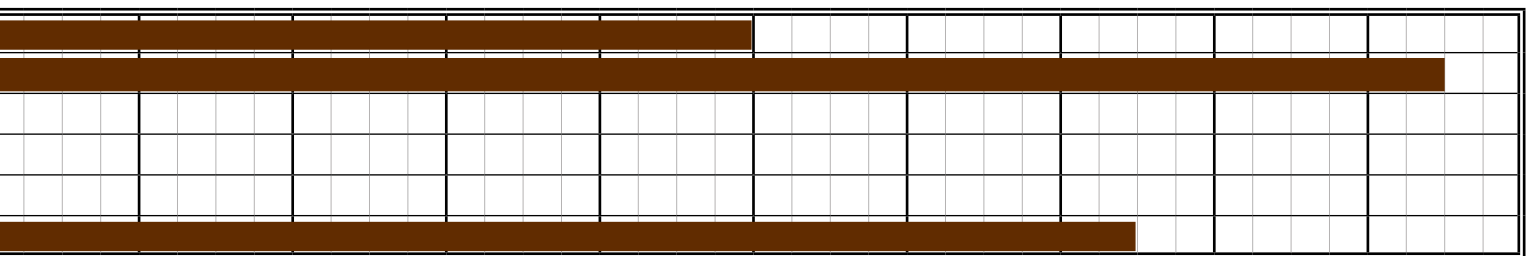
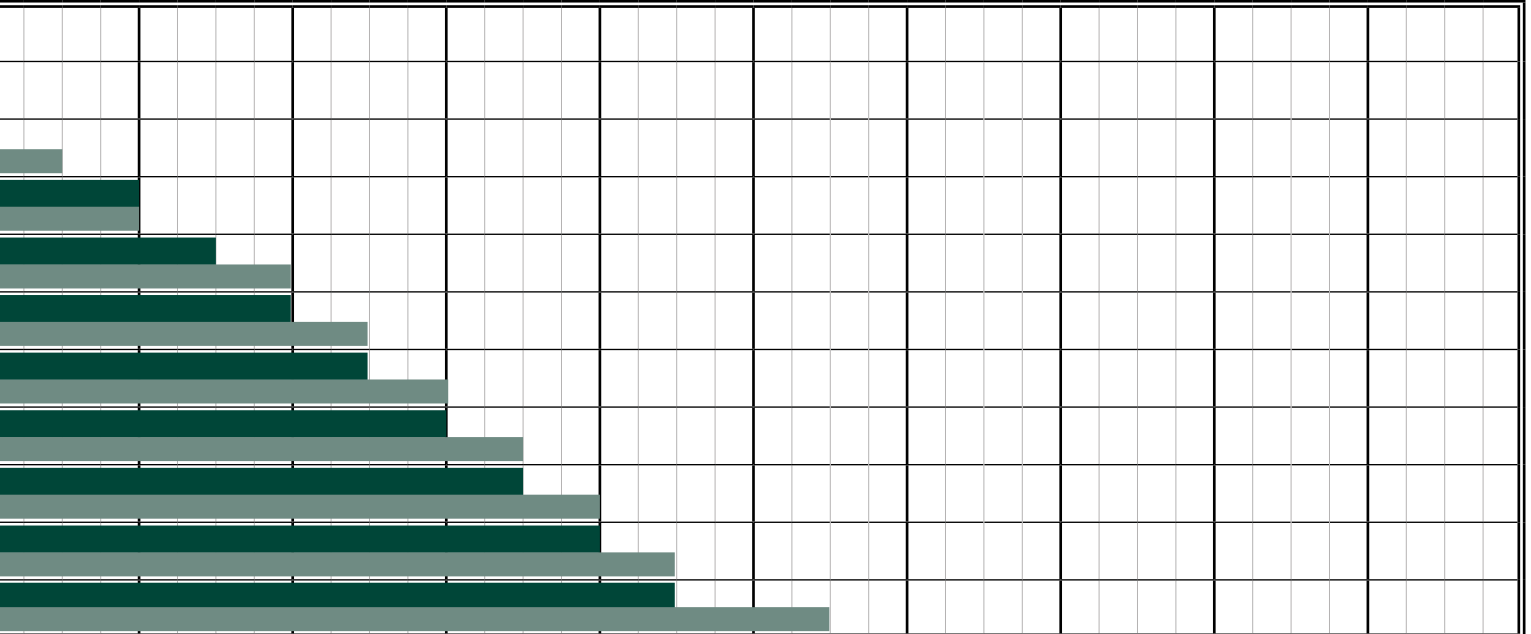
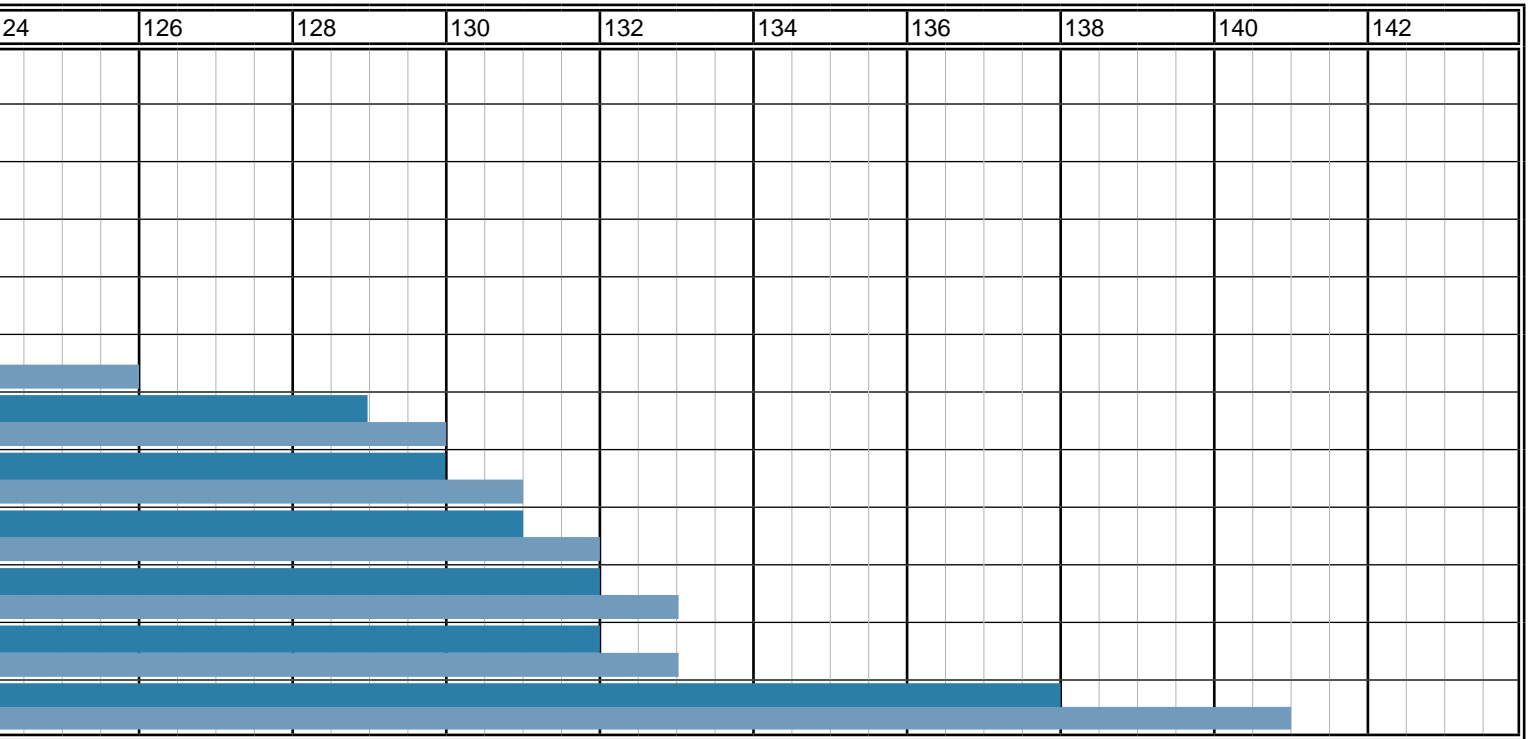

¹ Maximum calculated SPL (unweighted) at 1 meter, as stated on spec sheet.
² "Voice-range" for R.15 and R.35 models = Maximum continuous broadband output, Music/Voice switch in "Voice" position.
³ "Music-range" for R-MAX and R6 models = Maximum continuous broadband output over stated operating range with Equalization applied.
 "Voice-range" for R-MAX and R6 models = Maximum continuous broadband output over stated operating range without Equalization.

For a complete list of technical specifications for each model, please visit the Community website: www.communitypro.com

R-SERIES

APPLICATION SOLUTIONS



Unparalleled Musicality
Unsurpassed Performance
High Output
Superior Voice Projection
Legendary Weather-Resistance

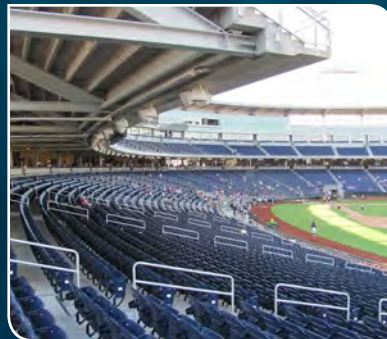

Community[®]

INNOVATIVE DESIGN. LEGENDARY SOUND.

Community Professional Loudspeakers
333 East Fifth Street
Chester, PA 19013-4511 USA
Phone (610) 876-3400 • Fax (610) 874-0190
info@communitypro.com

communitypro.com