

# Desono™ C-IC6 Ceiling Loudspeakers

## Installation & Operation Guide

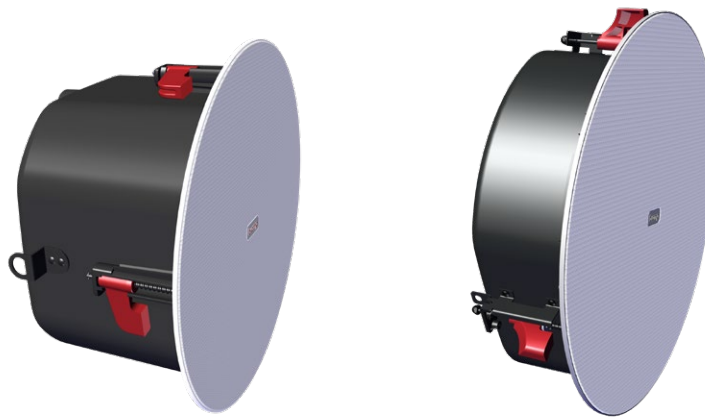

Models  
C-IC6, C-IC6LP

### PRODUCT INFORMATION

Desono C-IC6 Ceiling Loudspeakers are engineered and manufactured to be rugged and are carefully packed in sturdy cartons. However, it is wise to thoroughly inspect each unit after it has been removed from the packaging, as damage could occur during shipping.

All C-IC6 and C-IC6LP ceiling loudspeakers are shipped in pairs. Below is a representation of what is included. .

#### Box Contents:

C-IC6 / C-IC6LP Models:

- Ceiling loudspeakers and covers (2)
- Grilles (2)
- C-ring support plates (2)
- Cutout template (1) *C-IC6LP only*
- Paint masks (2) *C-IC6LP only*
- 24" (610 mm) Tile bridge rails (4)
- *Not Shown* - Euroblock connectors (2), Cable clamps (2) - *C-IC6LP only*, Documentation

#### C-IC6



#### C-IC6LP



A: 9300 S.W. Gemini Drive Beaverton, OR 97008 USA

W: [www.biamp.com](http://www.biamp.com)

# PRODUCT REPRESENTATION

## C-IC6

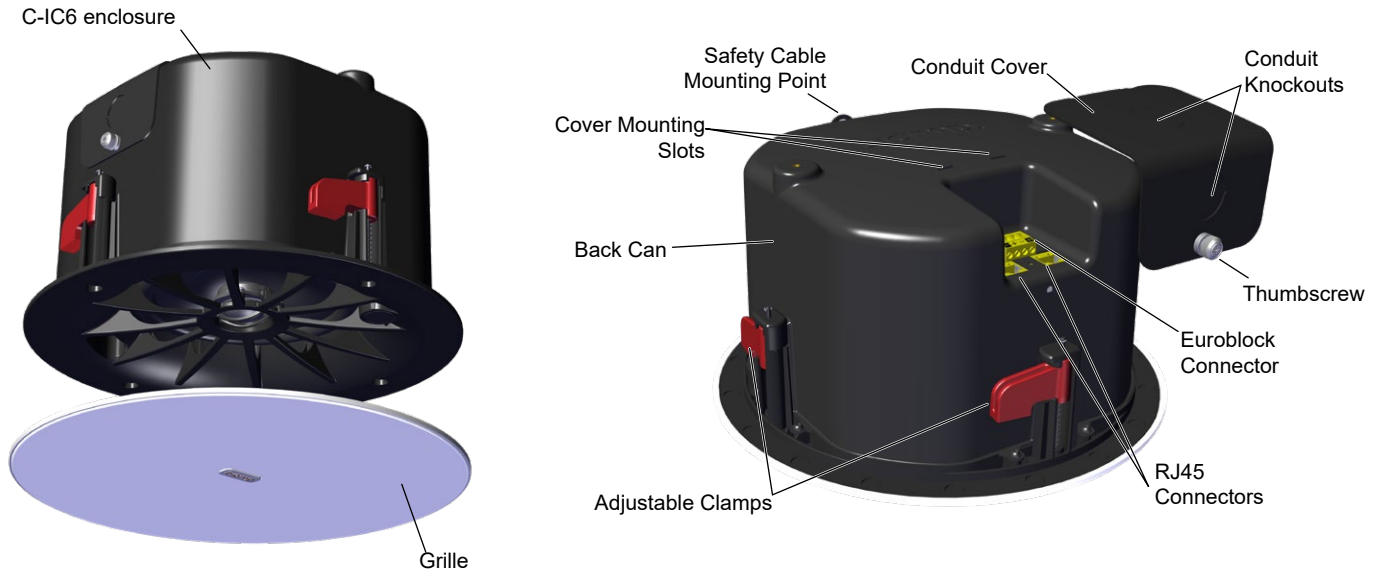

## C-IC6LP

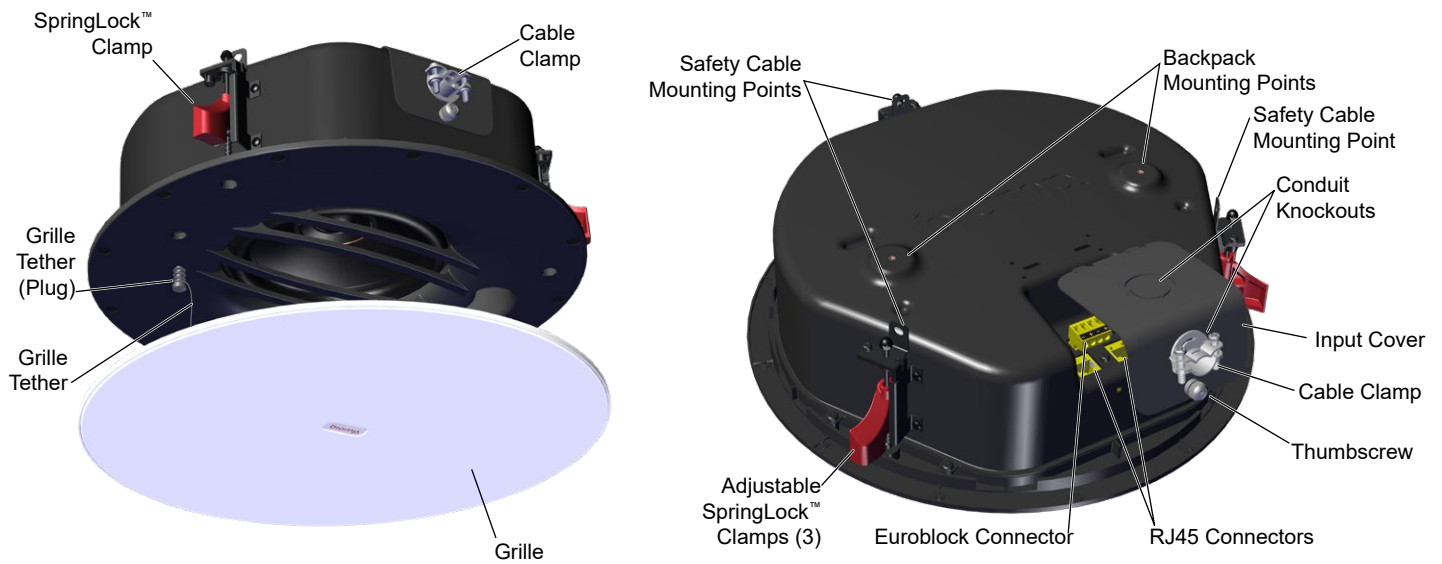

## RIGGING AND ELECTRICAL SAFETY



**IMPORTANT:** Please review the safety guide accompanying this product and these installation instructions prior to installing this loudspeaker.



**IMPORTANT:** The loudspeakers described in this manual are designed and intended to be mounted to differing building surfaces using a variety of rigging hardware, means and methods. Installation of loudspeakers should only be performed by trained and qualified personnel. All electrical connections must conform to applicable city, county, state, and national (NEC) electrical codes.



**DANGER:** It is possible to experience severe electrical shock from a power amplifier. Always make sure that all power amplifiers are in the "OFF" position and unplugged from an AC Mains supply before performing electrical work.



**CAUTION:** Installation of Biamp loudspeakers should only be performed by trained and qualified personnel. It is strongly recommended that a licensed and certified professional structural engineer approve the mounting. Severe injury and/or loss of life may occur if this product is improperly installed.



**DANGER:** It is advised that a safety cable be secured to a suitable load-bearing point separate from the primary loudspeaker mounting point, with as little slack as possible so as not to develop undue kinetic force if the primary mount were to fail.



**IMPORTANT:** This loudspeaker is approved for use in plenum air handling spaces.

# INSTALLATION

The C-IC6 ceiling loudspeaker models are designed to be installed with or without above ceiling access in drop ceilings. Prewiring and installation of optional New Construction Brackets (SPA-NCxxx) allows C-IC6 loudspeakers to be installed in new drywall ceilings. C-IC6 loudspeakers can be mounted in larger cutouts using optional ceiling trim rings (SPA-TR400).

 **NOTE:** All electrical installation connections for loudspeaker lines are subject to all applicable governmental building and fire codes. The selection of appropriate electrical hardware to interface with the loudspeaker lies solely with the installation professional. Biamp recommends that an appropriately licensed engineer, electrician, or other professional identify and select the appropriate conduit, fittings, wire, etc. for the installation.

## Installation in drop (suspended) ceiling (typical)

1. Run wires to the loudspeaker locations.
2. Remove the ceiling tile and use the C-ring or hole template to cut a hole in the center of the tile. Remove any debris from around the hole.
3. Place the tile rails on the grid and fit the C-ring tabs onto the rails. Secure the C-Ring to rails with screws (see detail below).
4. Reinstall the ceiling tile and align C-ring with the opening.

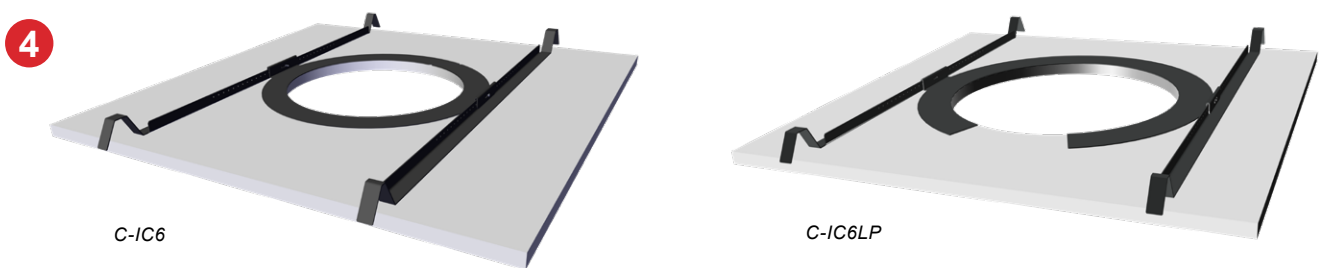
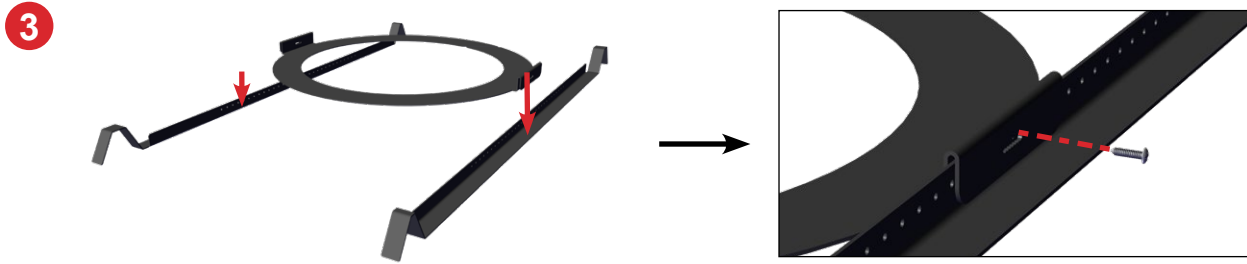
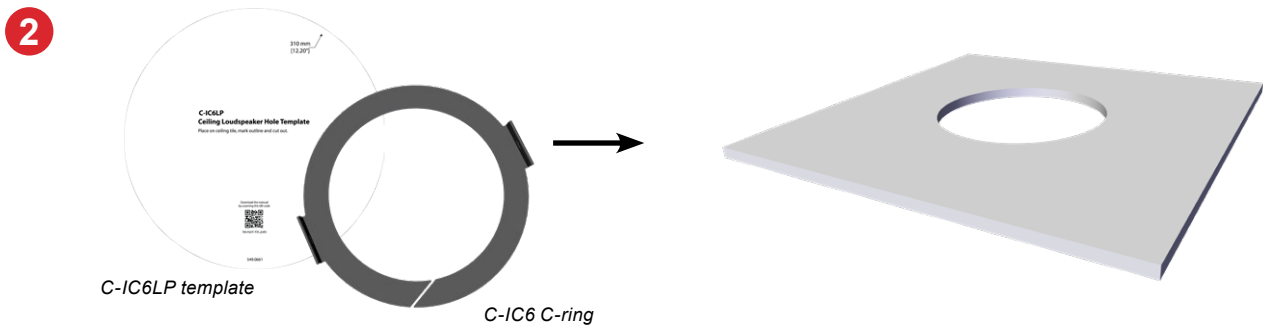

## Installation in a drop (suspended) ceiling with conduit

Prepare the ceiling tile as shown above. Access to the loudspeaker through an adjacent tile space is necessary to install the cover after the unit is installed in the ceiling tile. The included wiring cover has knockouts on the side and top (1/2" NPT (21.34mm), M20 (20.0mm), and PG13.5 (20.4mm)). Conduit fittings are not included. Use flexible conduit close to the loudspeaker to make alignment and connections easier. Run wires and conduit to the loudspeaker locations.

## INSTALLATION (continued)

### Installation Connections and Wiring

Biamp suggests using the cover with a cable clamp for wiring strain relief purposes.

5. Remove one of the knockouts from the cover and install the cable clamp (included with the C-IC6LP only).

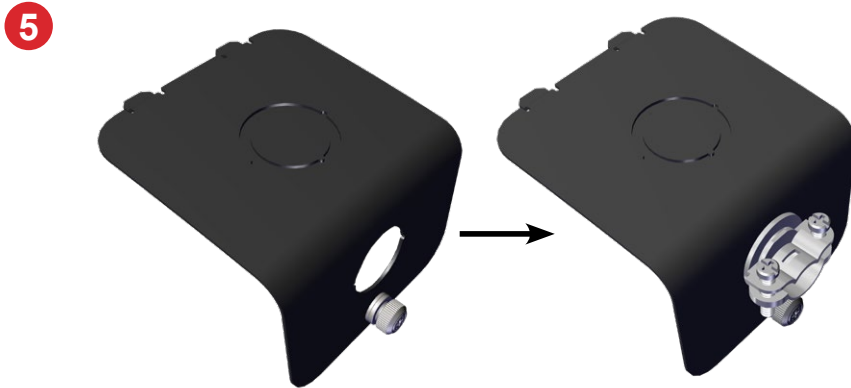

**Conduit installations:** Install a conduit fitting in the cover and wire per instructions.

**For Non-Conduit installations:** Use a cable clamp to secure the wiring to prevent accidental removal of the euroblock connector if the wires are pulled.

Install a cable clamp fitting in one of the knockouts and run cable through before wiring the connector. Tighten the clamp after the cover is installed to secure the wires.

6. Thread the cable or wires through the clamp and wire the euroblock connector as shown in Figures 1 and 2. Pay special attention to the labeled polarity. Loudspeakers may be daisy-chained by using the second set of terminals. The RJ45 ports may also be used for direct connection to Tesira devices.

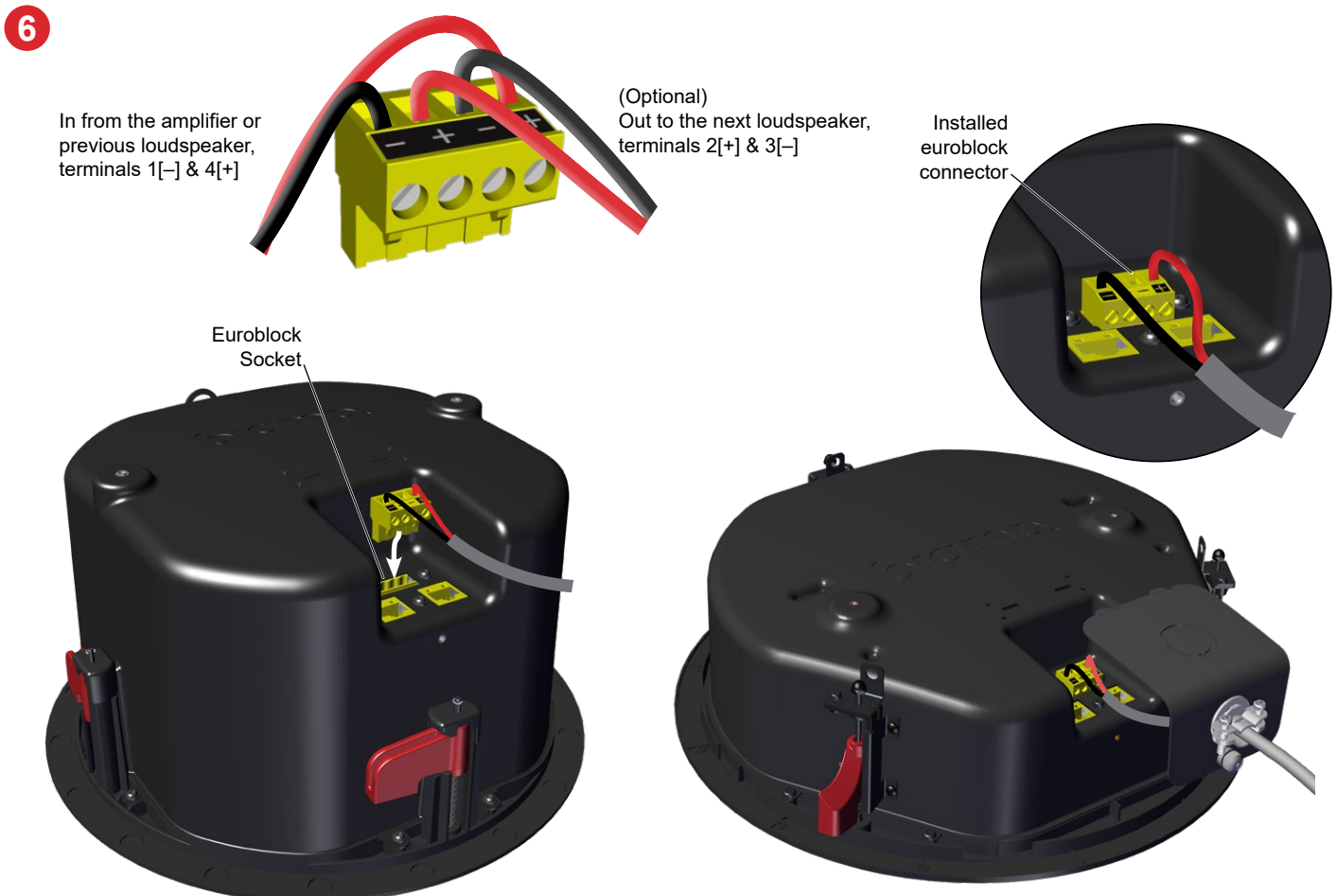

## INSTALLATION (continued)

### Installation in Ceiling

7. Install the cover. Insert the tabs into the slots and secure with the thumbscrew.
8. Tighten the clamp screws around the cable to provide strain relief.

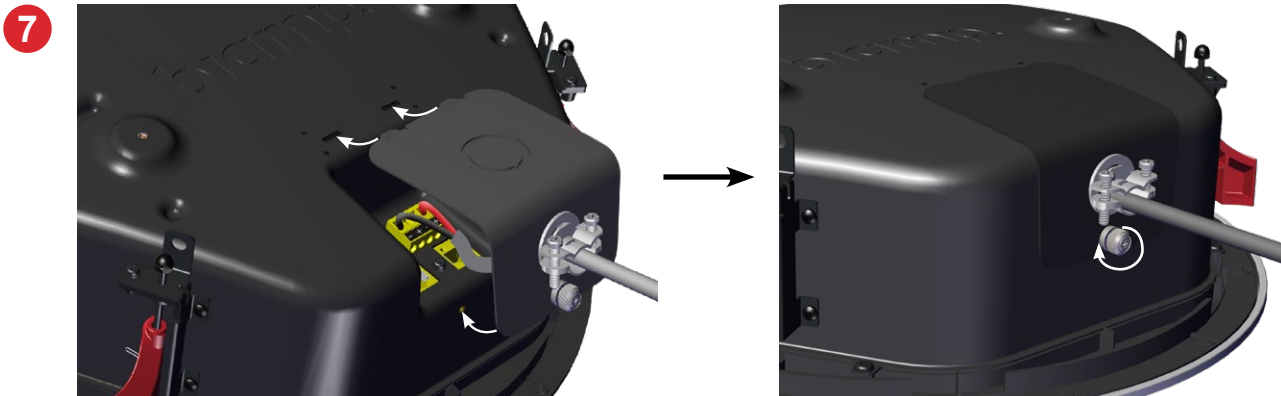

9. Secure a safety cable to the seismic safety tab. Make the cable as short as possible. Attach the cable to a secondary structural point directly above the seismic safety tab to minimize impact force and swing in the event of a ceiling failure.

**\*NOTE:** This can also be done after installing the unit if there is access in the ceiling.

10. **(C-IC6LP only)** If necessary, adjust spring clamps (with a Phillips head screwdriver) to allow slightly more space between the rim and the bottom of the spring clamp than the depth of the ceiling tile and C-ring together. The clamps should all be at the same height.

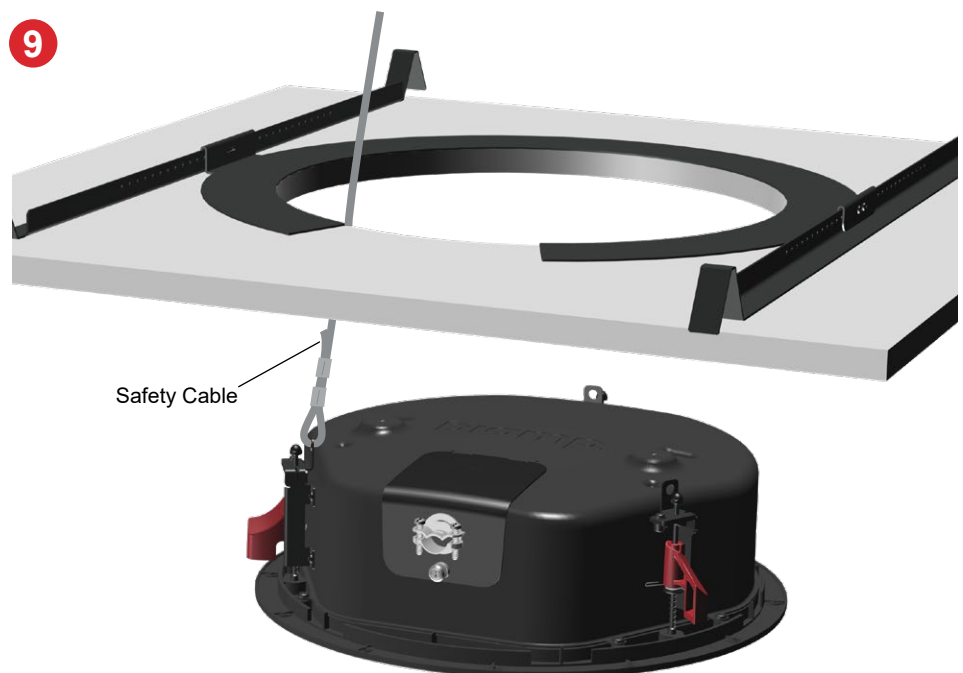

## INSTALLATION (continued)

The C-IC6LP's SpringLock™ clamps make installation easier since they will hold the unit in the ceiling once the clamps have cleared it and rotated back out. The C-IC6 must be fully supported until the clamps are screwed out and down.

11. **C-IC6LP:** Rotate loudspeaker clockwise as you insert it into the hole. This collapses the clamps as they move up through the hole (Figure 5 [a-d]). Once past the ceiling the clamps will spring out and prevent it from falling.

**C-IC6:** Insert the unit in the ceiling and support it until the clamps are screwed out and down in the next step. No rotation is necessary.

**IMPORTANT (both models):** The loudspeaker must be fully supported until the clamps are in their "out" position.

12. Push the loudspeaker up with the rim against the ceiling tile and tighten the screws (opposing sides first), to lower the clamps to secure it in the ceiling (Figure 5 a-e).

**NOTE:** Do not overtighten. If the ceiling tile is deformed, the grille may not stay on.

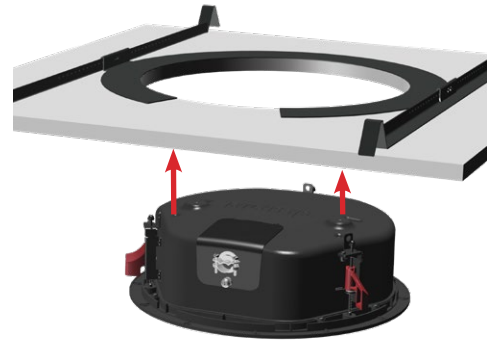

### C-IC6LP

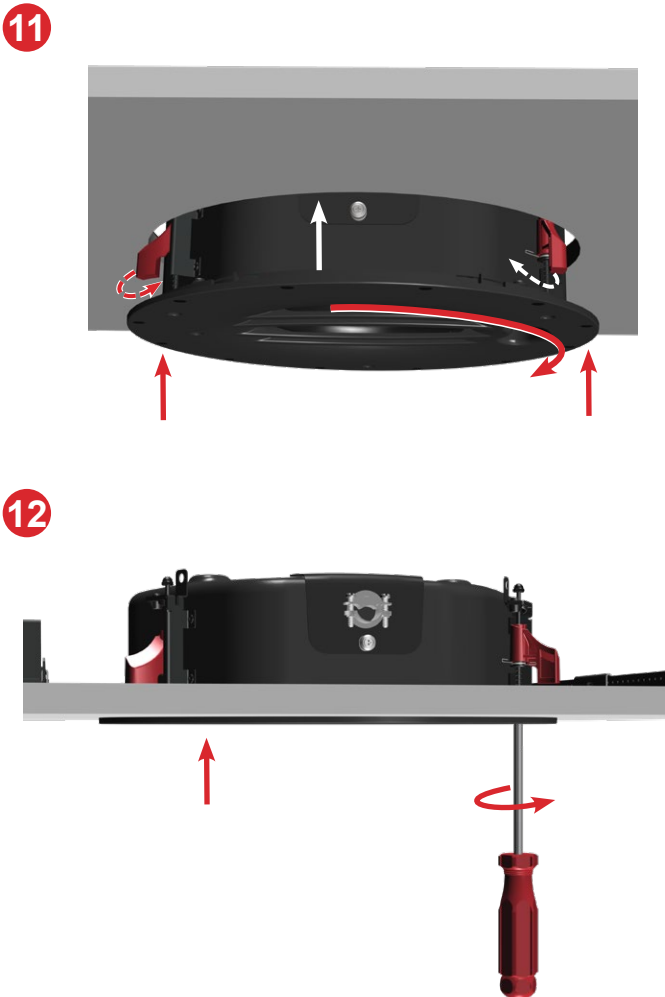

### C-IC6

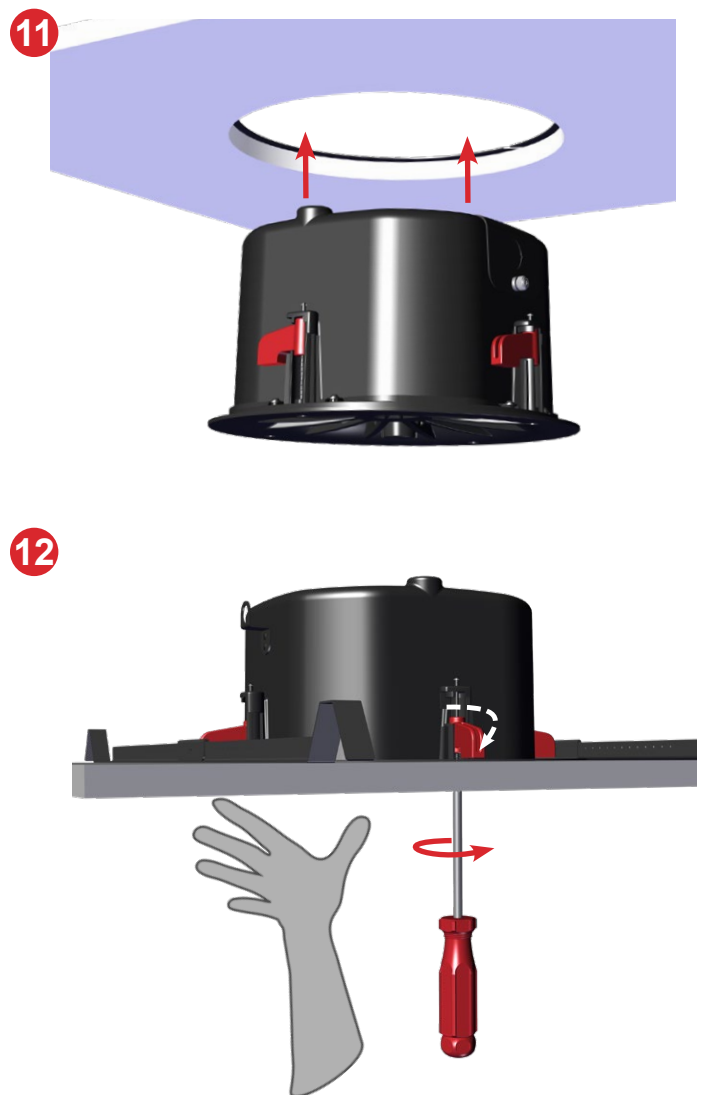

**IMPORTANT:** For closed ceiling applications all connections (wiring and safety cable) must be made (with the input cover installed) before inserting the unit in the ceiling.

## INSTALLATION (continued)

### Install Grille

13. C-IC6: (no plug tether, go to step 14)  
C-IC6LP: Fully insert the grille plug attached to the grille's safety tether into the empty hole in the loudspeaker face.
14. Place grille against the loudspeaker face. The magnets will hold it in place. Make sure the grille is fully seated on the loudspeaker face.

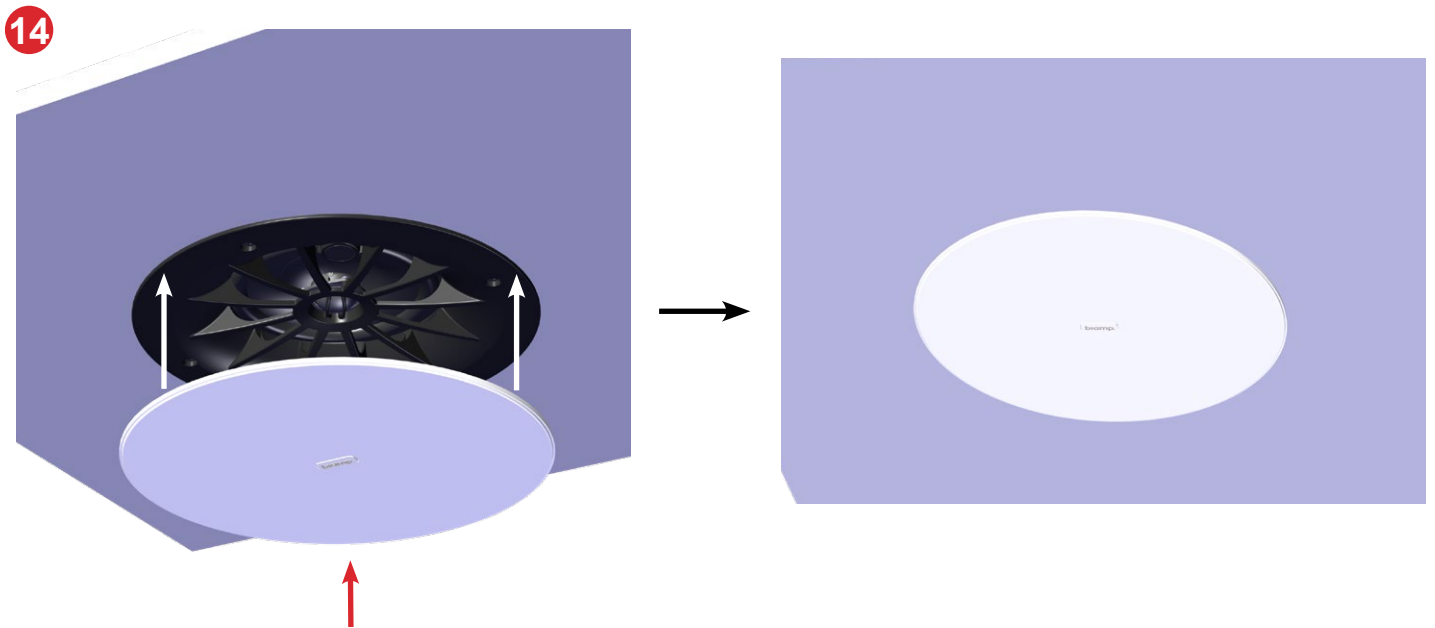
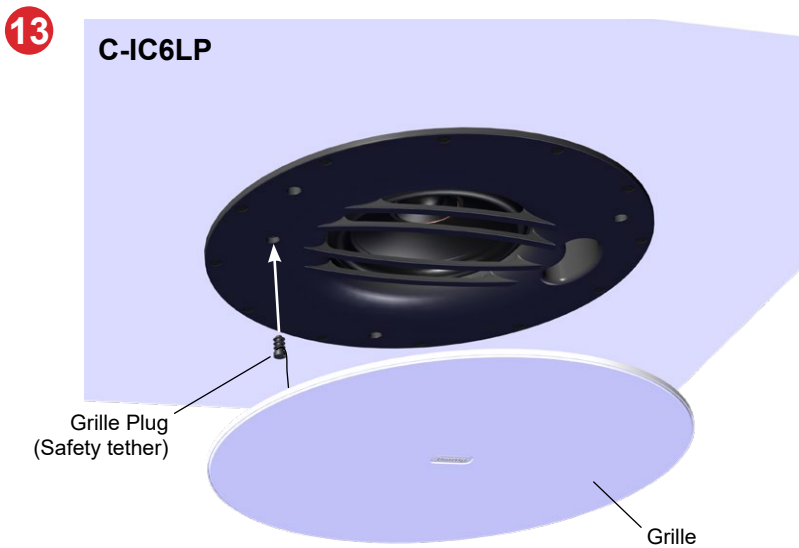

## INSTALLATION OPTIONS

### Installation in a drywall [sheet rock] ceiling

Adequate distance above the drywall must be available to accommodate the depth of the back can.

1. The appropriate size of new construction brackets (SPA-NCxxx) should be utilized and secured to the ceiling structure.  
**NOTE:** Use a stretched string or laser to align the brackets, rather than aligning to the truss.
2. Run wiring to each bracket location allowing sufficient length to allow for connection to the back can.
3. A safety cable should be attached to the structure with sufficient length to allow for connection to the back can.
4. Install the drywall and cut out the hole inside the bracket. Allow wires and cable to hang through the hole or be accessible in the ceiling.
5. After the ceiling is finished, install the loudspeaker (steps 5-12 of this guide - [pages 4-6](#)). Screwing down the clamps will secure the loudspeaker in the ceiling.
6. Finish the installation by installing the grille (steps 13-14 - [page 7](#)).

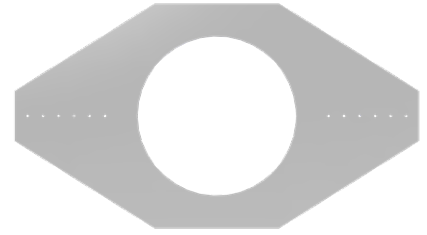

Model	Fits
SPA-NC400	C-IC6
SPA-NC500	C-IC6LP

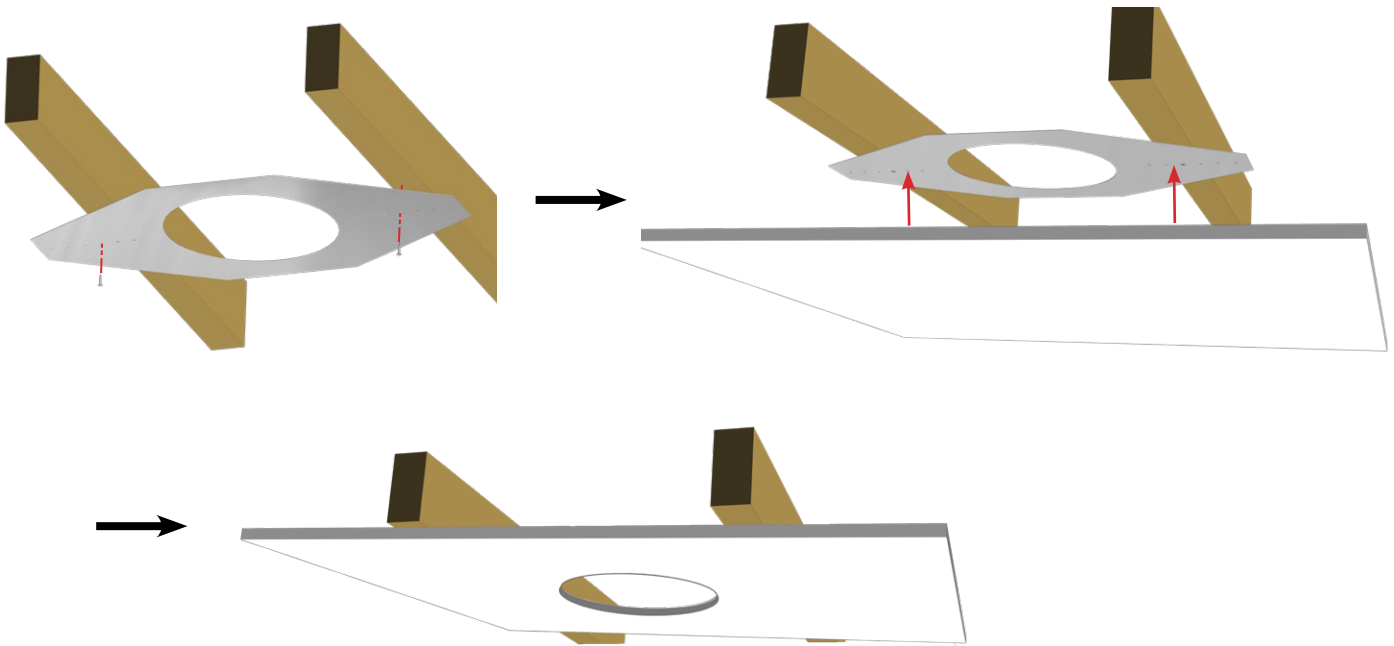



## LOUDSPEAKER REMOVAL

If there is a wired conduit connection to the loudspeaker, disconnect it first by removing the cover and terminal block or RJ cables.

Follow steps below to remove the loudspeaker from the ceiling (*C-IC6LP shown*).

1. Pull the grille down until the magnets let go, and remove the grille plug if applicable - C-IC6LP.
2. Loosen the clamps by turning each screw counter-clockwise until it stops. The clamp will travel up the screw and turn against the can. Repeat for all screws.



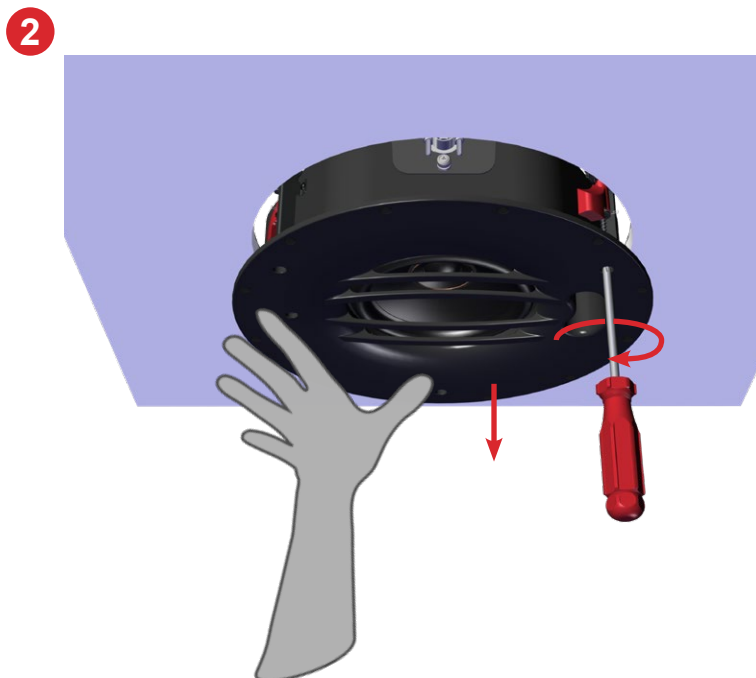
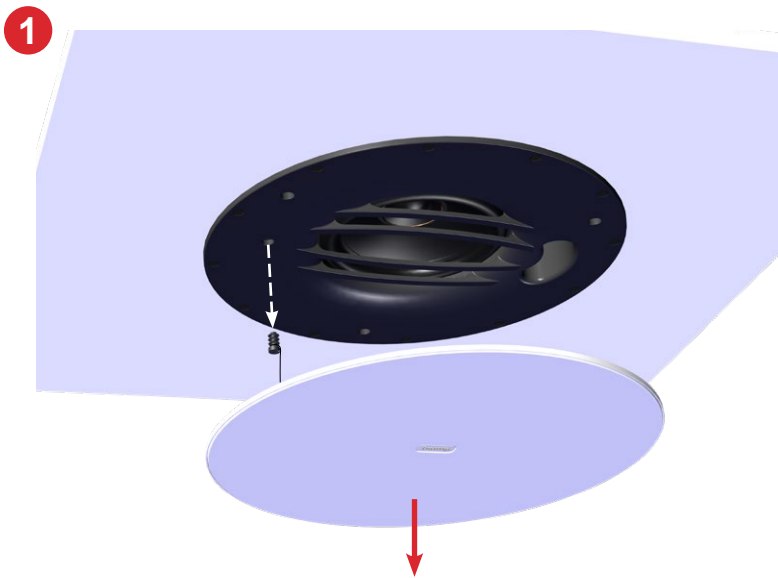

**CAUTION:** The loudspeaker must be fully supported as the clamps are turned to prevent it from falling as the clamps move up and in.

3. Remove the loudspeaker from the ceiling. Detach the safety cable (and wiring), if it wasn't removed previously.

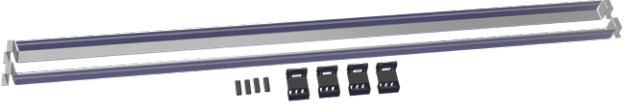

## DESONO CEILING ACCESSORIES

A variety of ceiling accessories are available to aid differing types of installations and applications. A complete reference guide noting part numbers and what they fit is available on the website as well as full installation guides for each type.

<b>SPA-GRB510</b>	Black accessory grilles for C-IC6LP	
<b>SPA-GHHxxx</b>	High humidity grilles	
<b>SPA-NCxxx</b>	New construction bracket for drywall or sheet rock ceilings.	
<b>SPA-RAIL48</b>	48" tile rails for installation in ceilings using 48" tiles	
<b>SPA-TR400</b>	Trim rings to allow C-IC6 models to fit in oversize holes	
<b>Desono BPAK</b>	Facilitates attachment of Tesira AMP-450BP, AMP-450P, TCM-X or TCM-XA to the top of either C-IC6 or C-IC6LP	

## PAINTING INSTRUCTIONS

The grille may be painted to match room decor. Do NOT paint the grille when on the loudspeaker. Remove the scrim material (cloth) prior to painting.

1. Purchase a citrus-based label/adhesive remover spray (PRF Label Off®, Goo Gone® or similar).
2. Pull the grille away from the face. Remove the tether plug from the face, do not bend the grille.
3. Gently pry the logo from the grille using a non-metallic tool, or fully mask the logo. Use a sharp knife to trim the masking material close to the edges of the masked areas.
4. Remove the grille cloth (scrim material) by spraying all of the fabric with the adhesive remover.
5. Wait a few minutes to allow the fabric to fully absorb the spray.
6. Carefully peel off the grille cloth, taking care not to rip or stretch the fabric.
7. Once the cloth and logo have been removed, some glue residue may remain on the grille. If so, apply additional adhesive remover to remove the glue.
8. Thoroughly clean and degrease the grille before painting. Do not use a solvent (see Cautions above).
9. Paint the grille with several light coats of spray paint at twice the recommended distance from the grille. Do not clog the grille perforations with paint.
10. Allow the paint to fully dry and cure.
11. If necessary, reattach the grille cloth. Use a light coat of simple spray adhesive. Avoid clogging the grille perforations with any adhesive.
12. Press and smooth the cloth on the grille.
13. Reattach the tether plug.
14. Reattach the logo if required.
15. Attach the grille to the loudspeaker per the installation instructions.



**CAUTION:** NEVER use abrasives, gasoline, kerosene, acetone, methyl ethyl ketone (MEK), paint thinner, harsh detergents or other chemicals on the loudspeaker. These chemicals and agents may permanently damage the finish. Some are also toxic and highly flammable.

**IMPORTANT:** Do not bend or damage the grille on removal or reinstallation.

**IMPORTANT:** Blocking the grille holes with paint or getting any paint on the drivers or internal parts will affect loudspeaker performance and void the warranty.

## CONTACT US

**Email:** [support@biamp.com](mailto:support@biamp.com)

**Web:** [support.biamp.com](https://support.biamp.com)

**Warranty:** [biamp.com/legal/warranty-information](https://biamp.com/legal/warranty-information)

**Safety & Compliance:** [biamp.com/compliance](https://biamp.com/compliance)



**A:** 9300 S.W. Gemini Drive Beaverton, OR 97008 USA

**W:** [www.biamp.com](https://www.biamp.com)

1JUN2023