



Multi Amplifier Remote Control (MARC) Software

QUICK START GUIDE 1.0.0



DYNACORD

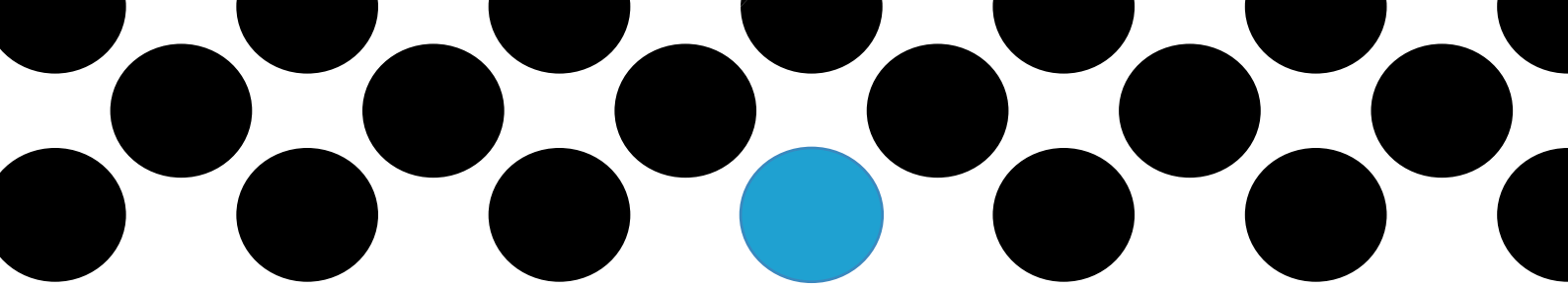

Welcome to Dynacord's Multi Amplifier Remote Control (MARC) Quick Start Guide.

We want you to get the most from your Dynacord amplifiers and encourage you to explore the additional ReadMe file provided with your software.

This Quick Start Guide is intended to help you get comfortable with basic set-up, work flow and outline good working practices.

This Quickstart Guide will cover:

- Getting Started
- Prepare a Project Offline
- Going Online with an existing Project
- Online Operation and Supervision
- General Topics

GETTING STARTED

Hardware and operating system

The Multi Amplifier Remote Control (MARC) software will work on computers with a Windows operating system. Minimum requirements are:

- Operating System: Windows 7, Windows 8.1, Windows 10
- CPU: 64 bit dual core @ 2.0GHz
- Screen resolution (min): 1024x748 pixel
- 4GB Memory
- USB 2.0 port.

The installed software package will require about 116MB on the hard disc drive. Please see the ReadMe file for detailed installation instructions.

USB connections

All L and C series amplifiers have a USB 2.0 port on the rear.

How to connect to a single amplifier

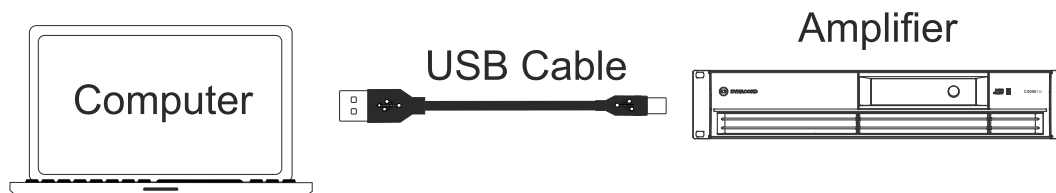

A single amplifier can be connected with a USB (type-A, type-B) cable to a computer.

How to connect multiple amplifiers

If you want to control multiple amplifiers simultaneously as a system, you can use “off-the-shelf” USB hubs* that use an external power supply.

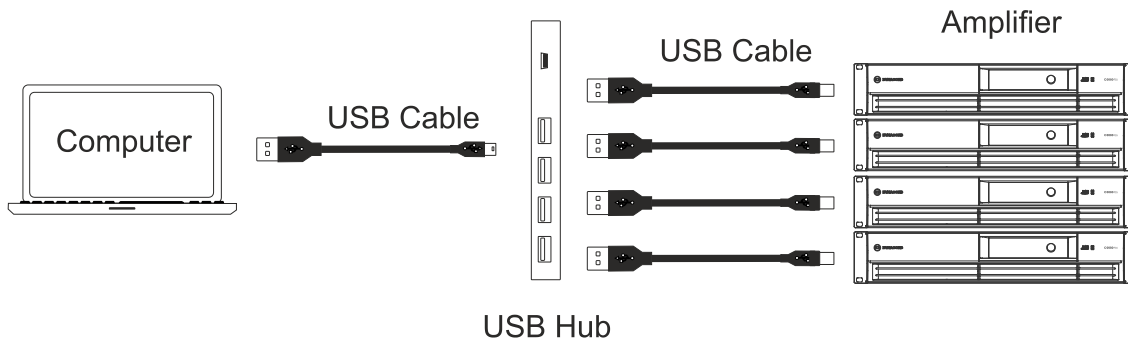

How to extend range for USB control

The USB standard is restricted to a cable length of 5 meters (15 ft). If you want to control amplifiers over a wider distance, you can use USB range extenders*. These extenders boost the USB signal and allow with a LAN cable distances up to 50 meters (150ft)**. A USB range extender consists of a transmitter and a receiver. The transmitter is connected to the PC on a USB port, while the receiver has one or multiple USB ports to connect the amplifiers.

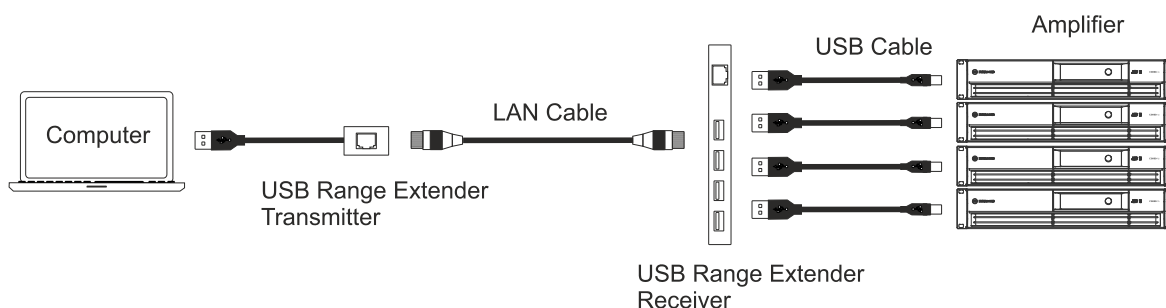

* We have tested successfully various makes and models, but can't guarantee for all.

** Actual range depends on manufacturer's specification, 50m is typical.

It is also possible to use multiple range extenders if the amplifiers are placed in different locations.

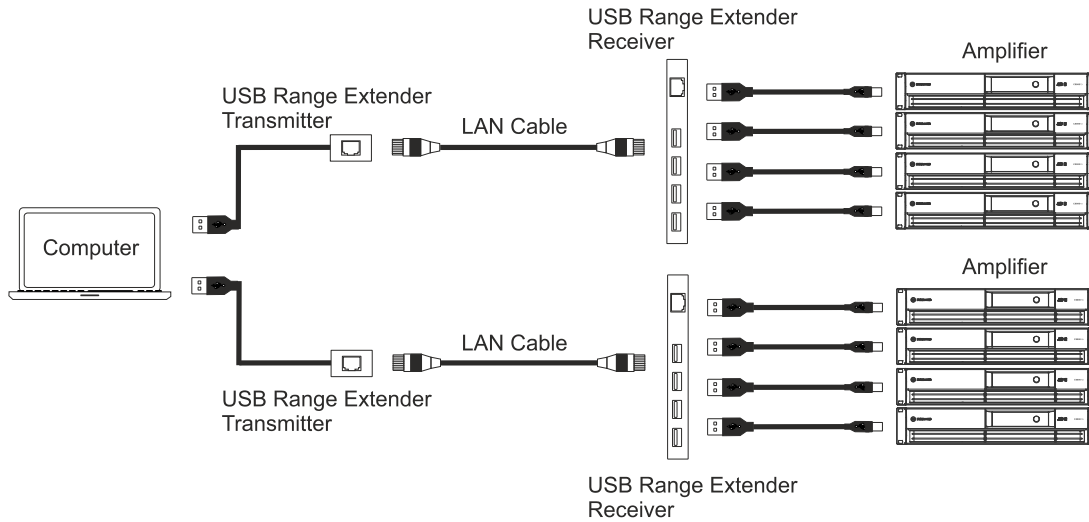

If you need to use more range extenders than you have USB ports on the computer, it is also possible to use a USB hub before a range extenders.

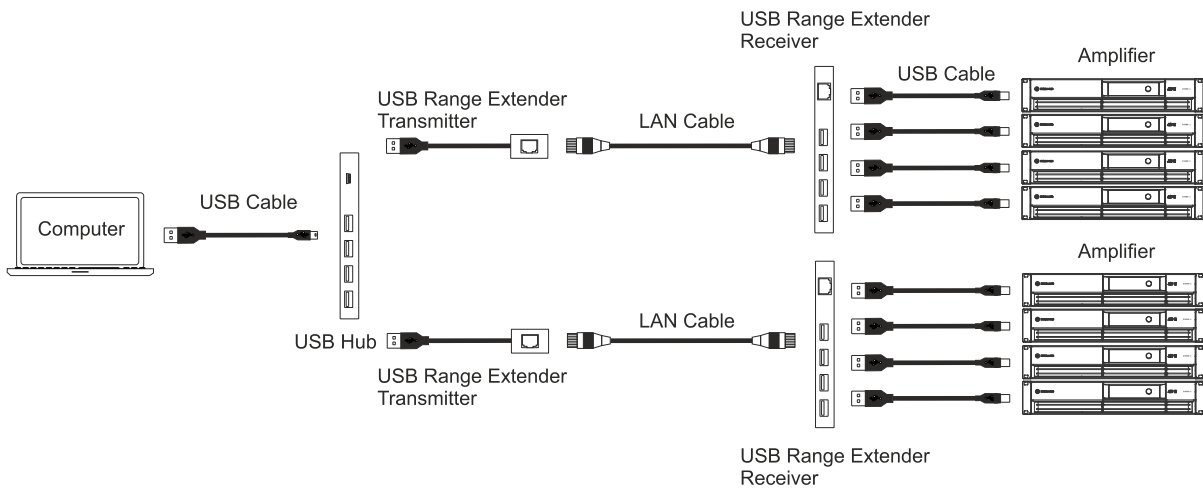

PREPARE A PROJECT OFFLINE

The Multi Amplifier Remote Control (MARC) software allows preparing a project file to configure and control a system of up to 8 L or C series amplifiers offline.

Start Multi Amplifier Remote Control (MARC) by double click on the icon on your desktop or in your program menu. The software will start with the: Home Screen.

NOTE:
FOR INSTALLATION NOTES PLEASE SEE THE README FILE.

Home Screen

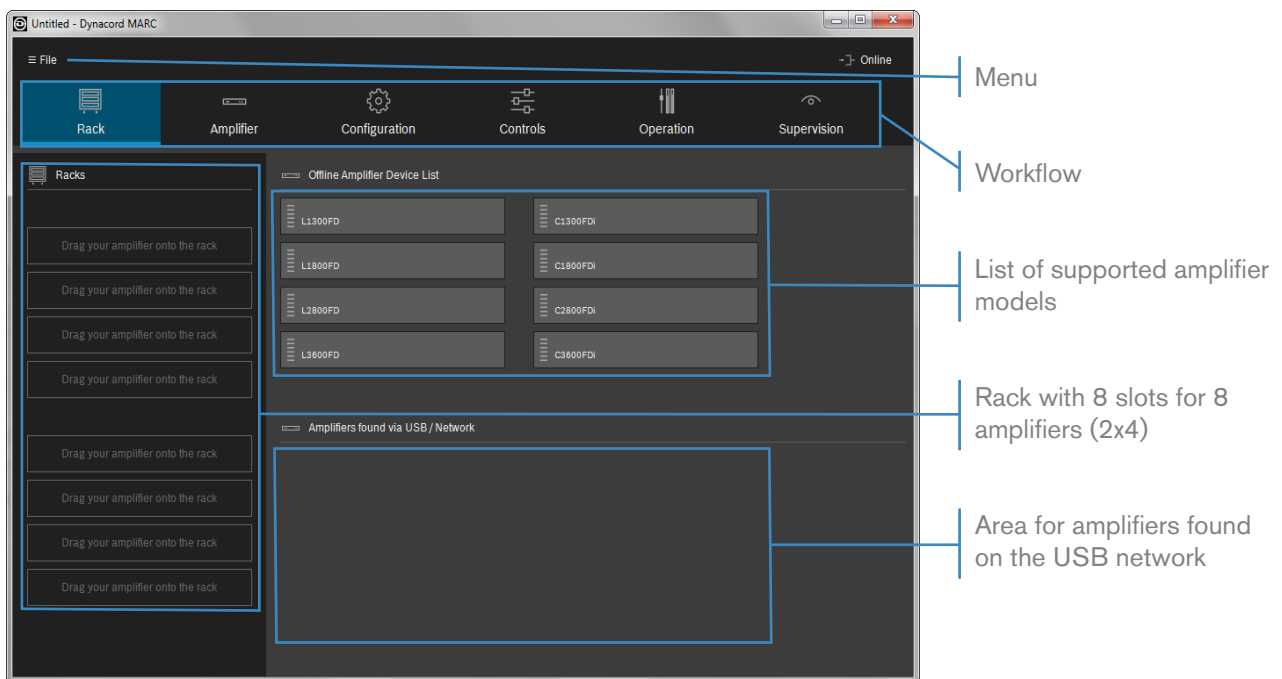

In the menu you find: New, Load, Save and Save as, Settings, Quick Start Guide and Exit. See chapter 5 for more details about the file menu.

The screenshot above is offline, with no amplifiers connected, so nothing is shown as "Amplifiers found via USB/ Network".

Start the Design

NOTE:

THE SOFTWARE WILL ONLY OPERATE AMPLIFIERS THAT ARE PLACED IN THE RACK.

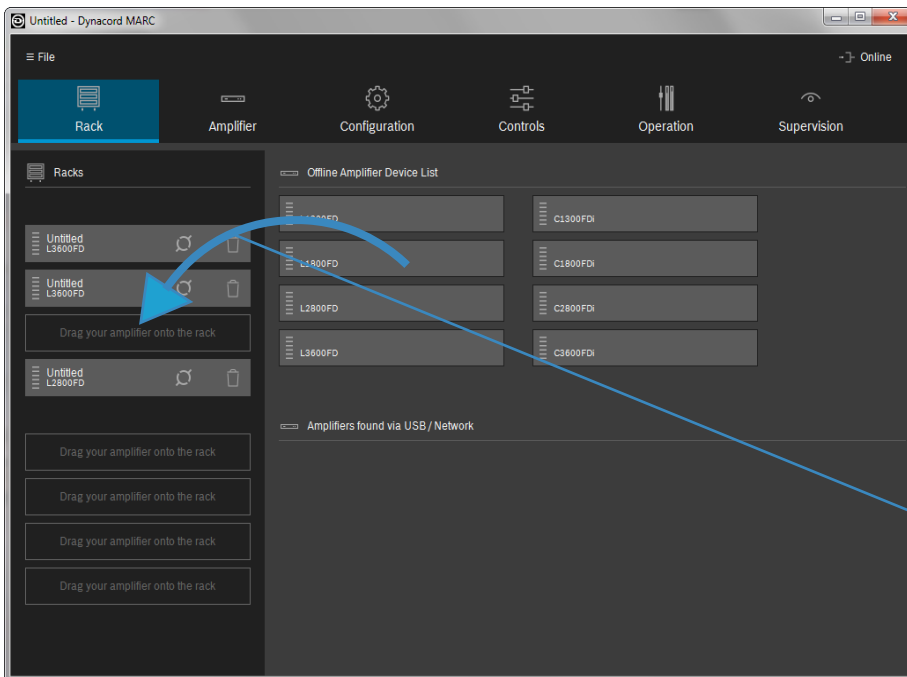

Drag and drop the amplifier models you intend to use from the Offline Amplifier Device List into the rack. Click on the trash icon to delete an amplifier from the rack.

Amplifier View - Configure the individual amplifiers

Select one amplifier after the other to label and set operation mode (normal or bridged mode)

You can label the amplifier for easier identification

Amplifier model and active preset shown

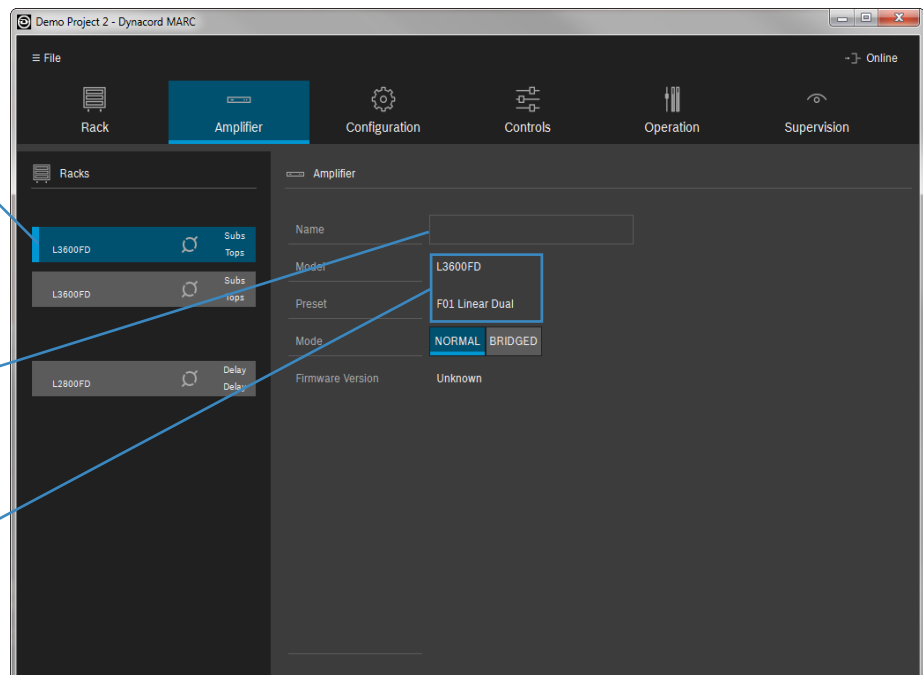

NOTE:

IF AMPLIFIERS ARE CONNECTED TO THE COMPUTER, THIS PAGE WILL ALSO SHOW THE ACTUAL FIRMWARE VERSION OF THE SELECTED AMPLIFIER. BELOW YOU WILL FIND THE UPDATE FUNCTION FOR FIRMWARE. IF NO AMPLIFIER IS CONNECTED (THIS EXAMPLE), THIS INFORMATION IS NOT SHOWN.

Configuration Groups - Load or create speaker settings, input routing

Warning Sign indicates that no amplifiers channels have been selected yet.

Label for configuration group = all amplifier channels that shall use the same speaker setting

Input Routing for all selected amplifier channels

Load speaker setting from file library

Use channel output processing (EQs, X-over, Delay, Limiter) for custom settings

Configuration groups contain all amplifier channels that shall use the same speaker setting.

This has no relation as to how you like to control the amplifier channels later (see control groups). The purpose is to save time and work consistently when multiple channels are connected to the same speaker type and hence require the same settings. A warning sign will show when no amplifier channels are assigned to a configuration group.

On this page you also select the input routing for all amp channels in the configuration group. Make sure that your wiring will follow what you select in software.

Input Routing A or B:

Use the signal on input A/B for the selected amp channels

Input Routing A+B:

Use a sum of signals connected to inputs A and B

Input Routing Stereo:

Puts input A to channel A and input B to channel B

NOTE:

WHEN USING A+B, THE SIGNAL IS +6DB HIGHER BECAUSE OF SUMMING. DEPENDING ON SPEAKER CONFIGURATIONS YOU MIGHT HAVE TO ADJUST LEVELS MANUALLY.

Below an example for a configuration group for speaker setting from the library.

Create a configuration group

Configure group label: "Tops" (could also be the speaker model/bandpass)

Input routing, e.g., both channels will be fed from input A

Selecting the amplifier channels of that group, e.g. all channels labeled "Tops"

Delete a configuration group

Add another configuration group

Use the "+" button to add another configuration group

File name of loaded speaker setting

Set upper and lower limit for load monitoring

NOTE:

THE README FILE WILL PROVIDE AN OVERVIEW ABOUT THE AVAILABLE SPEAKER SETTINGS AND THEIR DIRECTORIES AS THEY MIGHT CHANGE WITH REVISION OF THE SOFTWARE.

Shown above are four configuration groups (Tops, Subs, Delay, Config Group 4).

Once amplifier channels have been assigned to a configuration group, they disappear from the available channels – one amplifier channel can only be part of one configuration group.

If you assigned the wrong channels by mistake, you can delete the group and create a new one, or just deselect the wrong channels.

The upper and lower load limits determine the „Open“ and „Short“ warnings on the supervision page. The values can vary with the actual application depending on actual load. The default values of 1 Ohm (<1 Ohm will be shown as short) and 30 Ohms (>30 Ohms will be shown as „Open“) are good starting points and work for most low impedance application with standard cabling.

Use a configuration group for speakers without a factory speaker setting

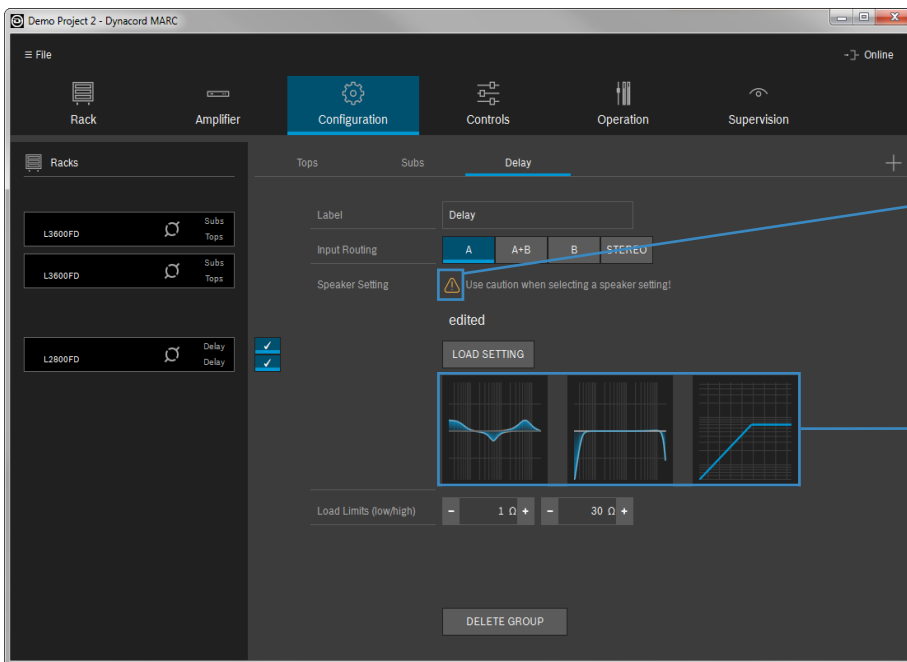

Warning message speaker settings, click symbol for further details

Use local editor of output DSP for speakers that don't require a dedicated speaker setting

From left to right you have EQ, X-Over and Limiter.

If you use speakers that don't require a dedicated speaker setting, you can manually edit the output EQ / X-Over / Limiter DSP blocks by clicking on the "preview" of EQ, X-Over and limiter.



Use caution when selecting a speaker setting. Loading or creating a speaker setting that does not fit to the connected loudspeakers may damage them.

NOTE:

IF YOU HAVE ALREADY ASSIGNED A SPEAKER SETTING FROM LIBRARY, YOU CAN'T ACCESS THE LOCAL EDITOR.

Quick Start Guide - PREPARE A PROJECT OFFLINE



You can activate a filter by clicking and moving the number in the frequency curve, or in the EQ selector.

Edit by dragging the filter point with the mouse or by typing in the "Frequency" and "Gain" values.

If you edit a parameter the value is shown in orange color: hit enter to confirm the value.

The available filters are the same as used in DSP600 or RCM26/28 DSP.

6 filters, choice of: Hi-Pass, Lo-Shelv, PEQ, Hi-Shelv, Lo-Pass, Allpass

When you select a filter its default state is in "bypass": you see the intended frequency response as a line. If you deactivate "bypass", the resulting response of the filter will be shown as shaded area.



NOTE:

YOU CAN CHANGE THE VERTICAL RESOLUTION OF THE DISPLAY (DB SCALE) WITH THE MOUSE WHEEL.

X-Over Section: Hi-Pass and Lo-Pass (Linkwitz-Riley 12dB, 24dB, Butterworth/Bessel 12dB, 18dB, 24dB, underdamped 12dB, 6dB slope) gain trim, polarity, alignment delay.

Make sure the limiter "BYPASS" button is off if you want the limiter to be active and protect your speaker system.

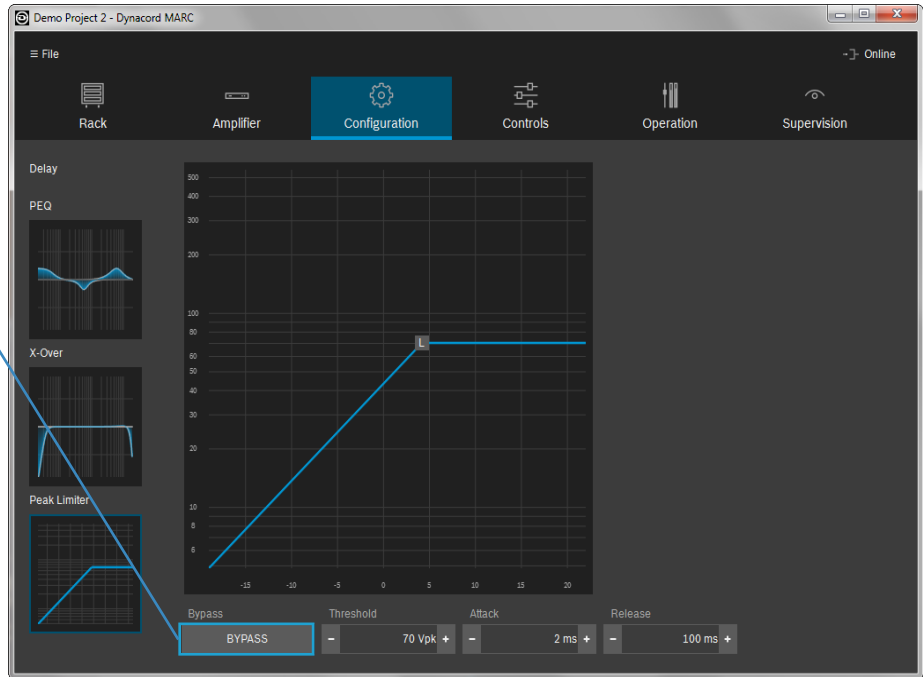

Peak-Limiter: You can enter values for threshold, attack and release. The limiter is only active if "Bypass" is deactivated.

Control Groups

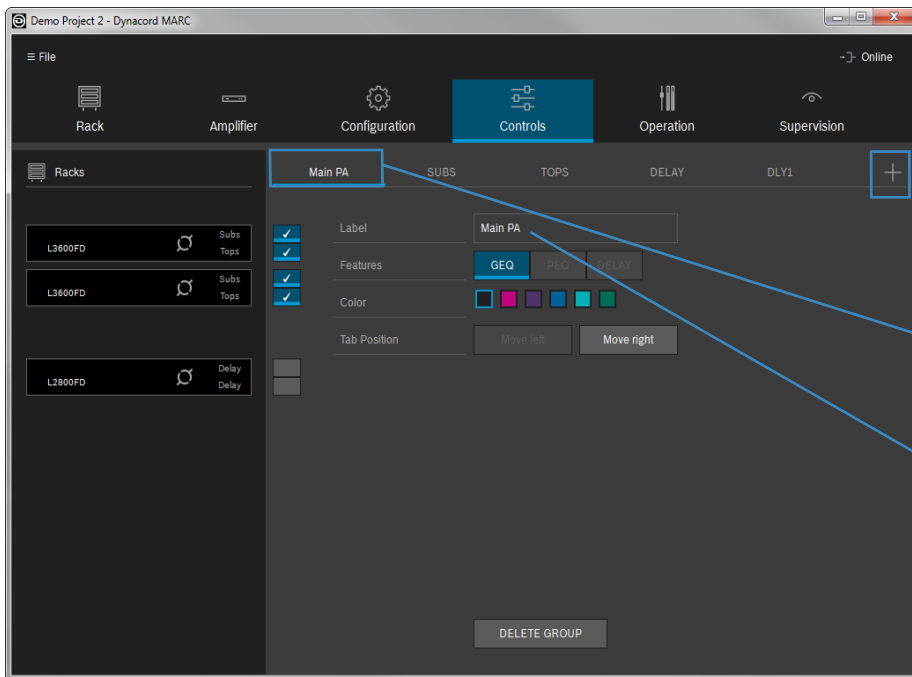

Hit "+" to add another control group

Control Group Tab

Control Group Label

Control groups are virtual groups that link parameters from amplifier channels to control them simultaneously (e.g. a control group Main PA might contain all channels with subs and tops, but not the delay speakers).

Creating control groups in Multi Amplifier Remote Control (MARC) software provides a lot of flexibility to cope with the individual requirements of the application. By default a control group links level, mute and VU metering (input and output) for the assigned amplifier channels on one control template.

Each group can have one or more control function blocks in addition: 5-band PEQ, 31-band GEQ or output delay (up to 650ms). A selectable control function (GEQ, PEQ, DELAY) of an amp channel can only be assigned to exactly one Control Group.

Creating a Control Group

Select amp channels that belong to the Control Group

Select control function block for this group, e.g. PEQ and Delay

Select a color code for this group

Example above is showing a group “Subs” with assigned channels A of the first two amplifiers. PEQ and Delay are selected as common control function blocks for all “Sub” channels.

You can create up to 16 control groups. An amp channel can be assigned to multiple Control Groups for level control. However, the GEQ, PEQ and DELAY features of each channel can each be controlled by at most one Control Group.

Quick Start Guide - PREPARE A PROJECT OFFLINE

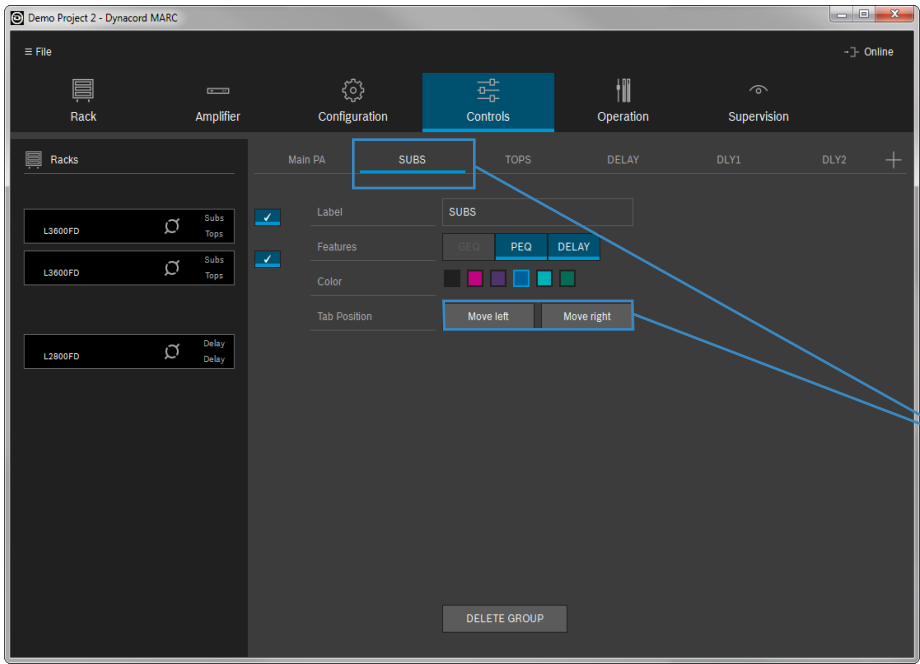

Control groups are listed from left to right as they get created. Use the "Move Left/Right" button to move a selected control group to the left/right.

Operation - Controlling the System (offline)



Control Group label with color coding

Control Group function blocks

Control Group level fader and input/output metering (max.)

Control Group Mute

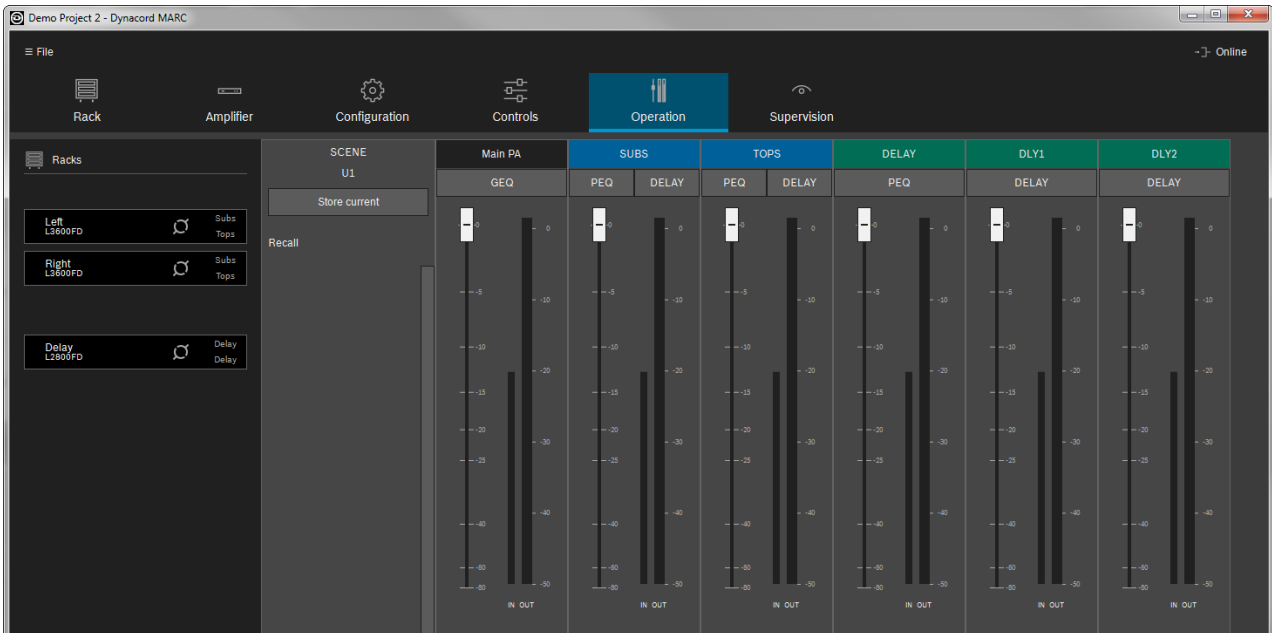

The example with six control groups shown above has the following assignments:

GROUP	AMPLIFIER			CONTROL FUNCTION BLOCKS		
	Left	Right	Delay	GEQ	PEQ	Delay
Main PA	Ch A & B	Ch A & B		X		
Subs	Ch A	Ch A			X	X
Tops	CH B	Ch B			X	X
Delay			Ch A & B		X	
Delay1			Ch A			X
Delay2			Ch B			X

This allows individual PEQs and delays for tops and subs to compensate for physical distance and required tuning, as well as a common “master” fader, mute, VU metering and GEQ for the entire main PA.

The two delay lines (one amp channel each) have independent delays to compensate for different locations, while the “delay master” provides a PEQ, fader, mute and VU metering, effecting both together.

Should the application require different assignments, it’s very easy to create different groups or assign the control function groups differently.

If amplifier channels are assigned to multiple control groups, the levels for faders work relative while the VU metering is showing the max. value of any of the controlled channels. Be aware that the group level may (and usually will) differ from the amp channel levels. Individual channel levels are shown with green line markers along the group fader scale.

Quick Start Guide - PREPARE A PROJECT OFFLINE



Green lines show individual channel levels

Flag on Mute for "Main PA" because not all channels in this group (e.g. SUBS) are muted

Mute or Unmute are always executed for amplifier channels assigned to the control group. If a channel is assigned to multiple groups, always the last action is followed. Depending on channel assignment this can cause an "error flag" on a mute button, indicating that some group members have been unmuted since the group mute was activated.

Operation - GEQ, PEQ and Delay for Control Groups

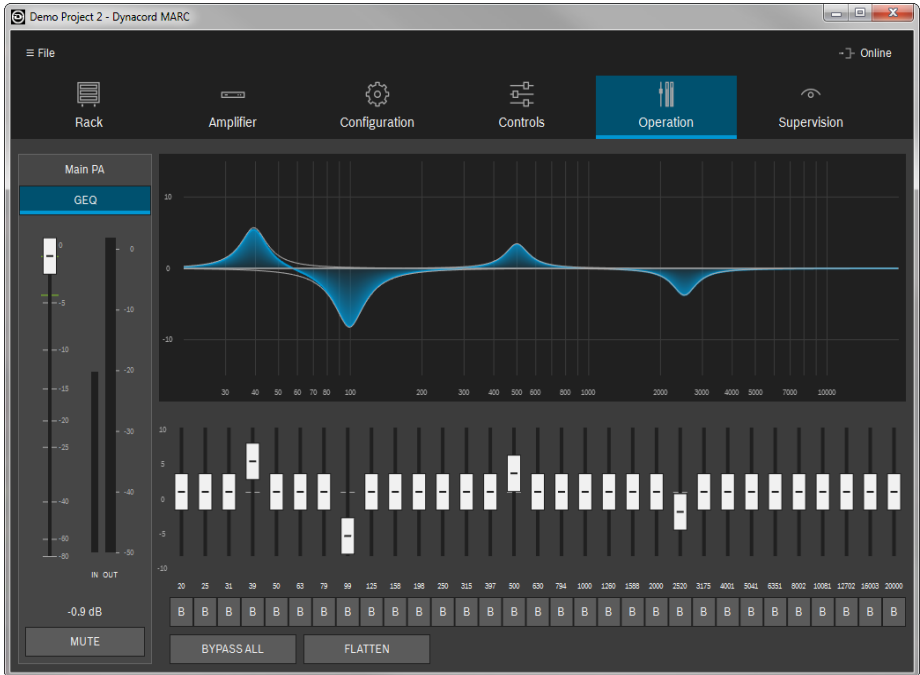

31-band graphical equalizer (GEQ): B allows bypass of an individual filter. Display resolution can be adjusted with right mouse click and scroll. Group level, mute and metering are available on the left side. Flatten puts all filters back to 0, double-clicking a fader will reset to the 0dB position, a bypass makes the GEQ inactive.



Shaded area is showing filter active

5-band parametric equalizer (PEQ): Filters can be edited by mouse, scroll wheel or entering parameter values. While editing via mouse and scroll wheel are instantaneously, editing numeric values (figures turn to orange) needs to be confirmed with “Enter”.

If a delay has been assigned to this group, it is shown on top. Editing by moving the speaker or entering a numeric value.

Scene Manager - Save and Recall User Presets for the System

Multi Amplifier Remote Control (MARC) software also allows to save different settings for one system into the amplifiers. This is very common if you have different operation modes that require a different level, different EQ or some muted channels on the same system.

To store your current system setting to a User Preset on your amplifiers: under “Scene” hit “Store current”!

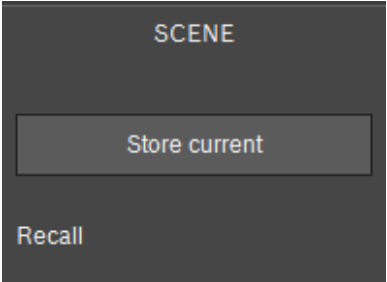

NOTE:
YOU CAN USE THESE USER PRESETS/SCENES ALSO LIKE MUTE GROUPS, E.G. ONE PRESET CAN INCLUDE ALL CHANNELS MUTED.

Quick Start Guide - PREPARE A PROJECT OFFLINE

You can then label the presets (scene) and select the user preset number you want to have it stored.

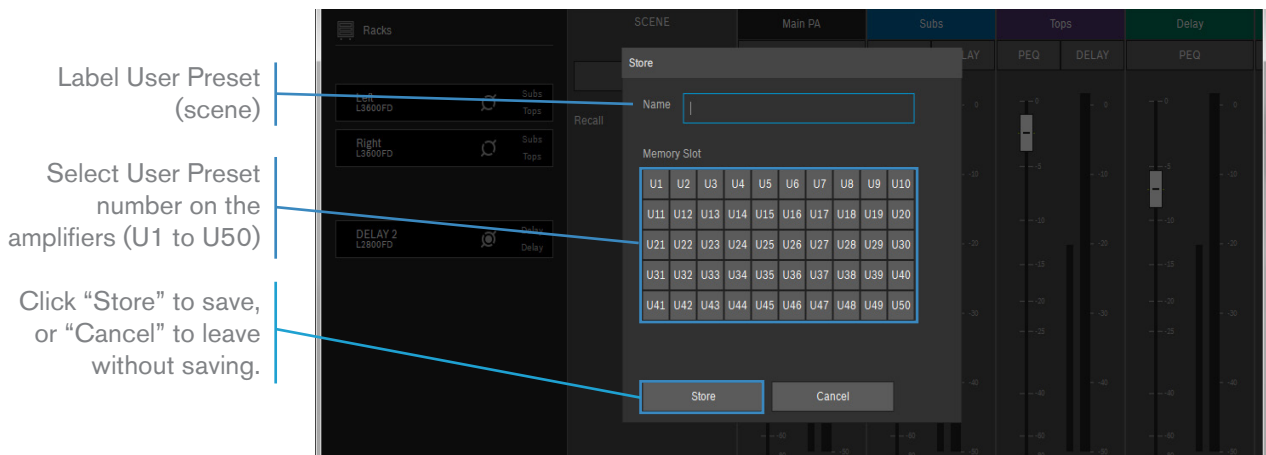

As soon as you select a User Preset number (U01 to U50) and click "Save", the current setting with the label in the display is saved in the project files while all the actual parameter settings are saved into all connected amplifiers and the project file.

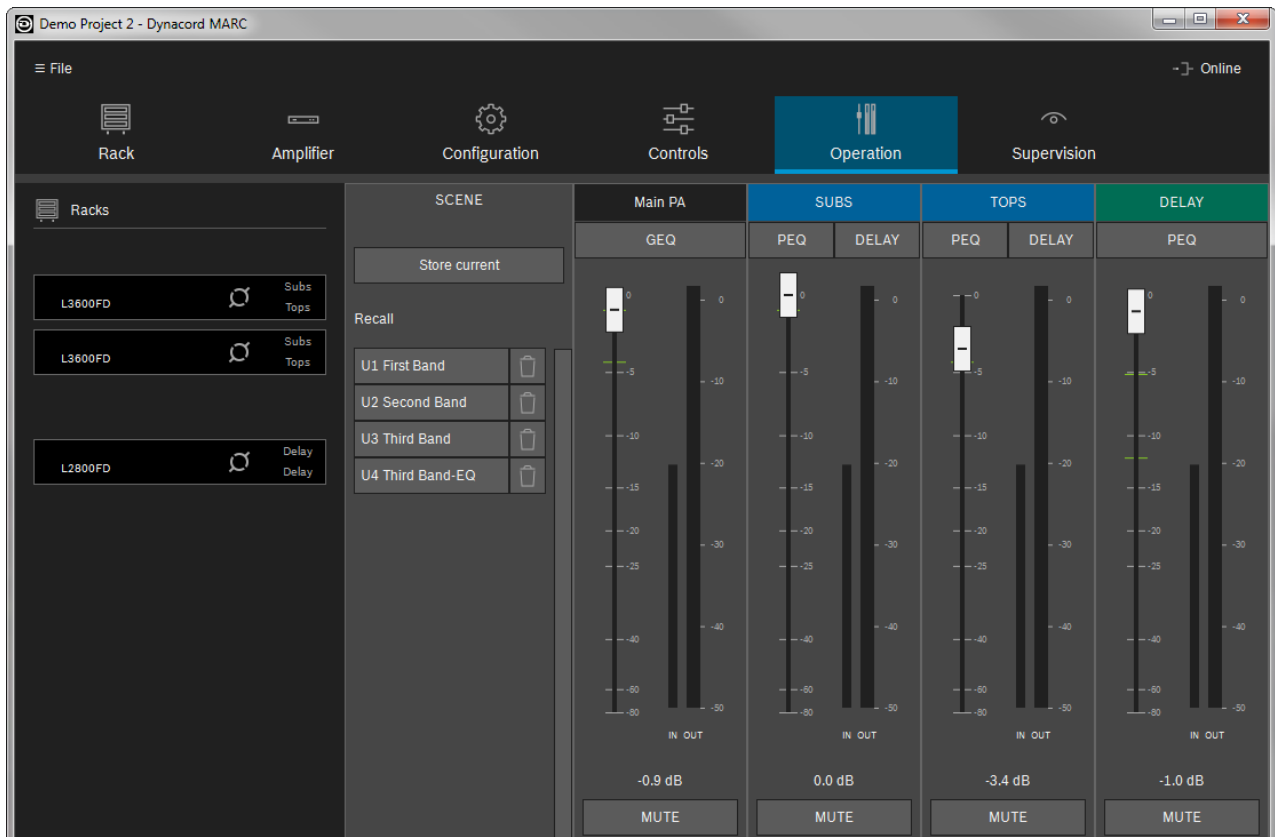

The User Presets are listed next to the Control Group operation panels. To recall a preset just click on the label (you will get asked to confirm the recall), to delete a user preset just click the trash icon.

Save your project File

Once all your settings are done, open the main menu to save the project file on your hard disk.

Save Project file: save to create a new or update the current project

Save as: create a copy of the current project file

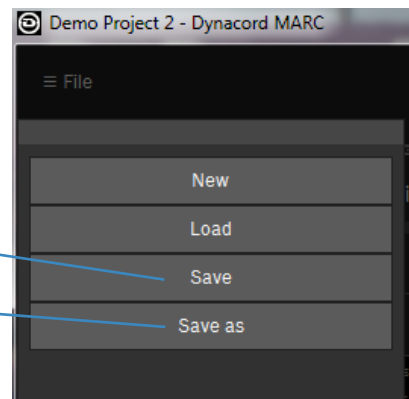

GOING ONLINE WITH AN EXISTING PROJECT

Start Multi Amplifier Remote Control (MARC) software and open your project file. The first action now is to match the physical amplifiers on the network with the templates in the project file.

Matching Amplifiers

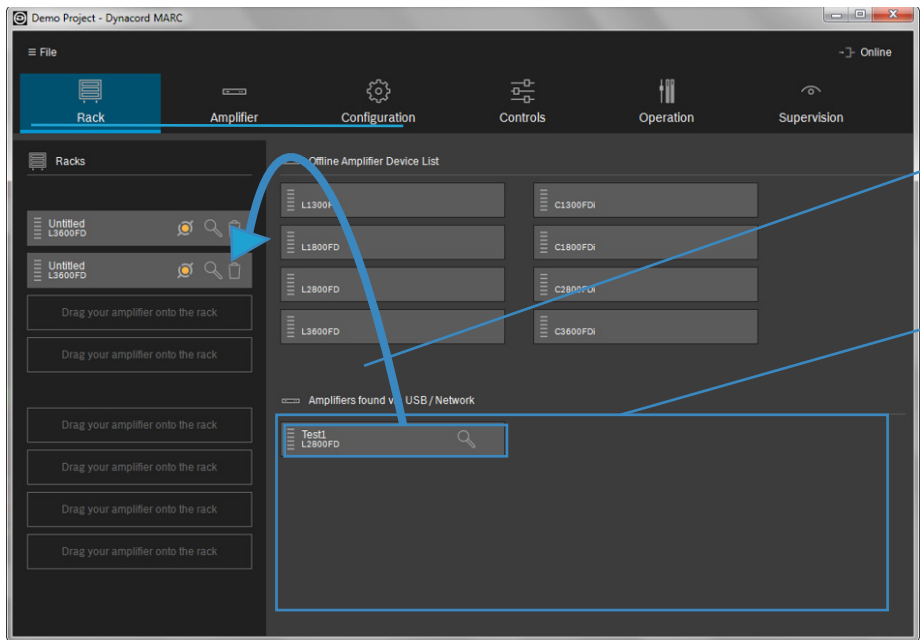

Drag and drop the physical amplifier to the rack amplifier

Amplifiers found on the network will be shown here

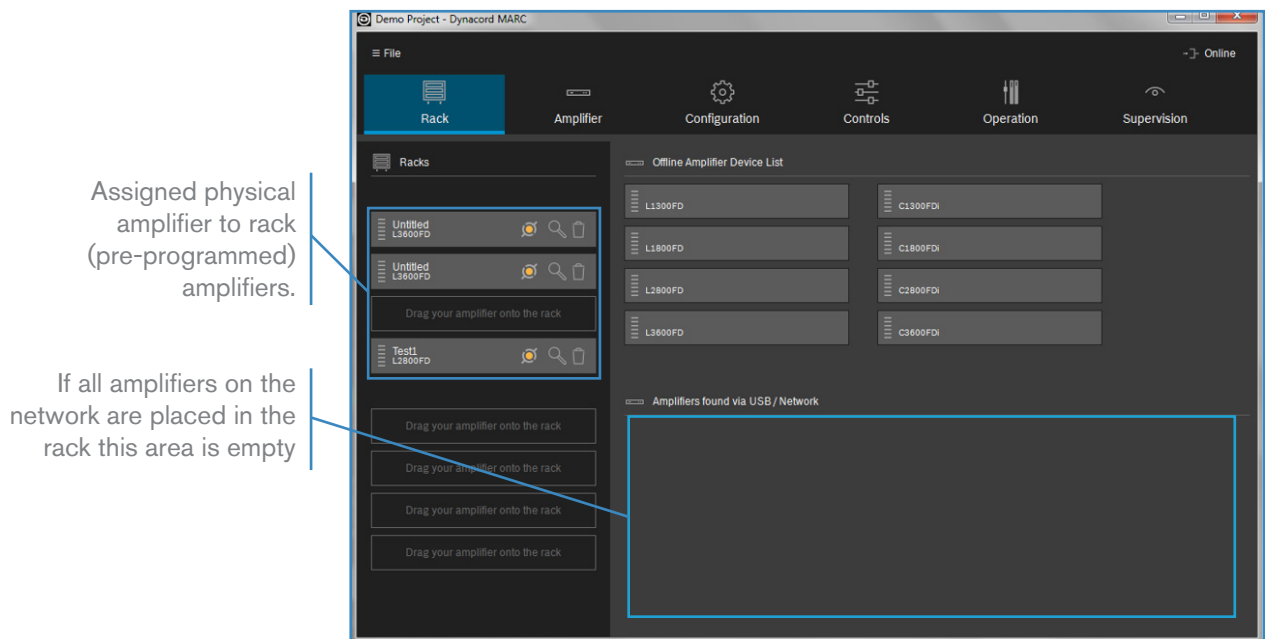

Assigned physical amplifier to rack (pre-programmed) amplifiers.

If all amplifiers on the network are placed in the rack this area is empty

Once a physical amplifier gets matched with an amplifier in the rack (pre-programmed) this is shown by the yellow “active” icon.



You can use the find function to check if you have matched the correct amplifier in the rack. As soon as you click on the magnifying glass icon the amplifier's LCD display will flash displaying the slot number in the rack (1 to 8, top down). In this example it should show “Slot 4”. The L3600FD you want to use for left PA shall be in slot 1 and for right PA in slot 2.

NOTE:

THIS STEP IS VERY IMPORTANT - PLEASE PAY ATTENTION THAT YOU ASSIGN THE PRE-PROGRAMMED AMPLIFIERS TO THE INTENDED AMPLIFIER THAT IS WIRED WITH YOUR SPEAKERS. MIXING UP AMPLIFIERS CAN CAUSE BAD PERFORMANCE AND DAMAGE TO YOUR SPEAKER SYSTEM!

Going Online

Click on the gray “Online” button on the right upper corner. You’ll get prompted this message:

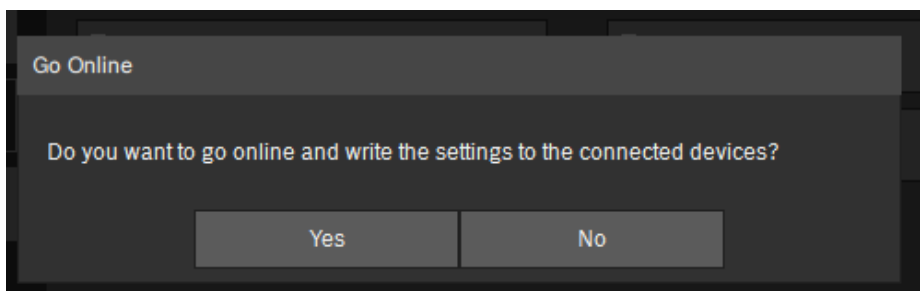

Click on the Yes button if you want to go online, writing all the current project data to your amplifiers.

ONLINE OPERATION AND SUPERVISION

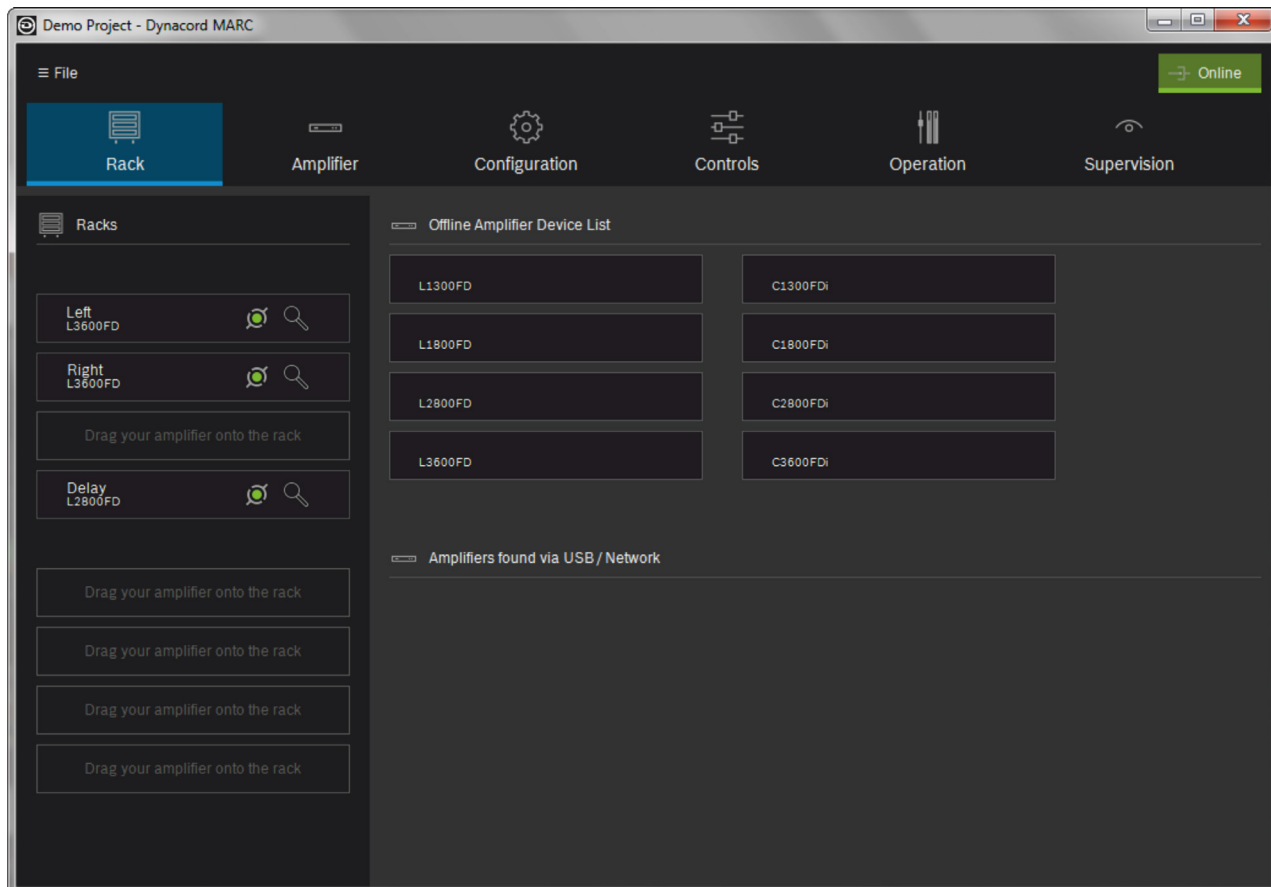

The upper right "Online" icon will turn green and a remote power on/off button will be displayed (C series only) and the yellow "active" icon on the amplifiers will turn green as well. Now all amplifiers have the configuration you prepared offline in your project file.



If you click on “Operation”, you can now start controlling your amplifiers in real time. If signal is present, the VU metering will display input and output signals.

If you have created user presets in your project file, you can now use them to recall, as well as create new ones. For live application this can be very useful to have settings for different acts on stage. In installed systems one can prepare a system that shall be remotely changed via GPI (C series only) with a common switch between two operation modes – not using the software. For set-up of the GPI please refer to the manual of C series.

NOTE:

AS LONG AS YOU STAY ONLINE YOU WON'T BE ABLE TO CHANGE YOUR SPEAKER CONFIGURATION. IF YOU WANT TO DO THAT, YOU NEED TO GO OFFLINE FIRST.

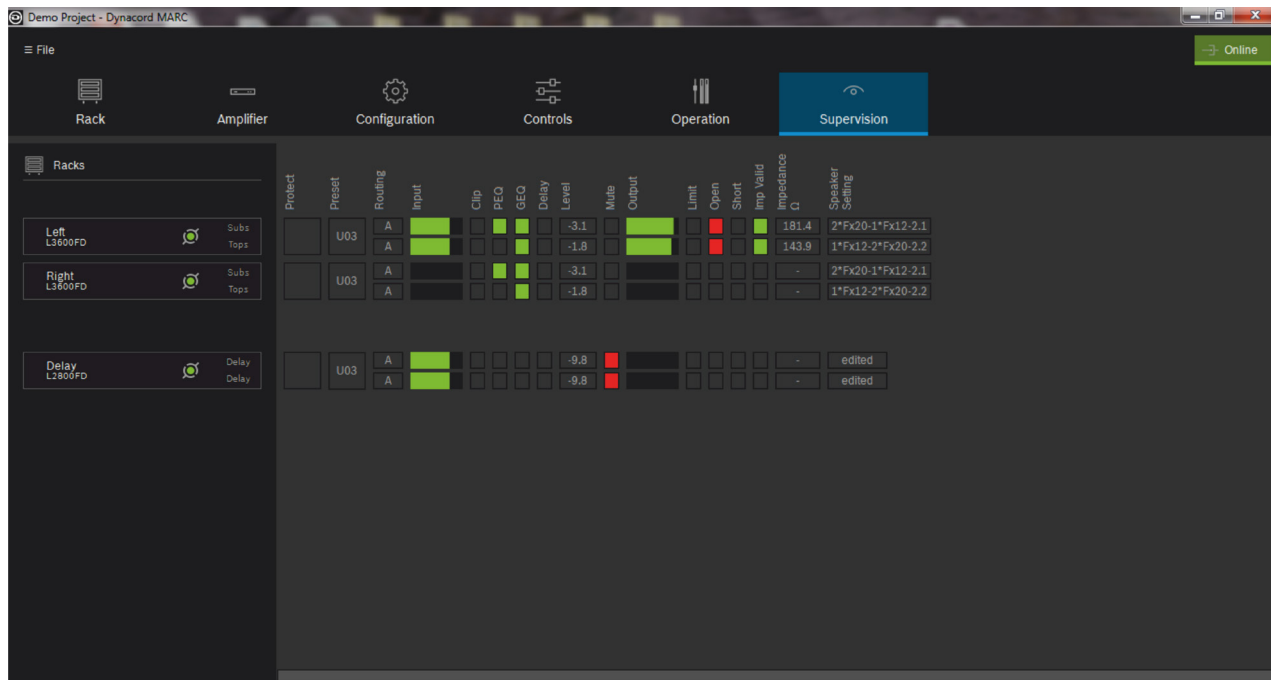

The supervision page is showing for all amplifiers:

health (protect status), current user preset, input routing and metering with clip indication, use of PEQ, GEQ, Delay, Level, Mute, output metering and limit, open/short detection, current load (average) in Ohms and name of the loaded factory speaker setting or a manually created output signal processing.

GENERAL TOPICS

Menu and Settings

If you click on “File”, the below menu will show up.

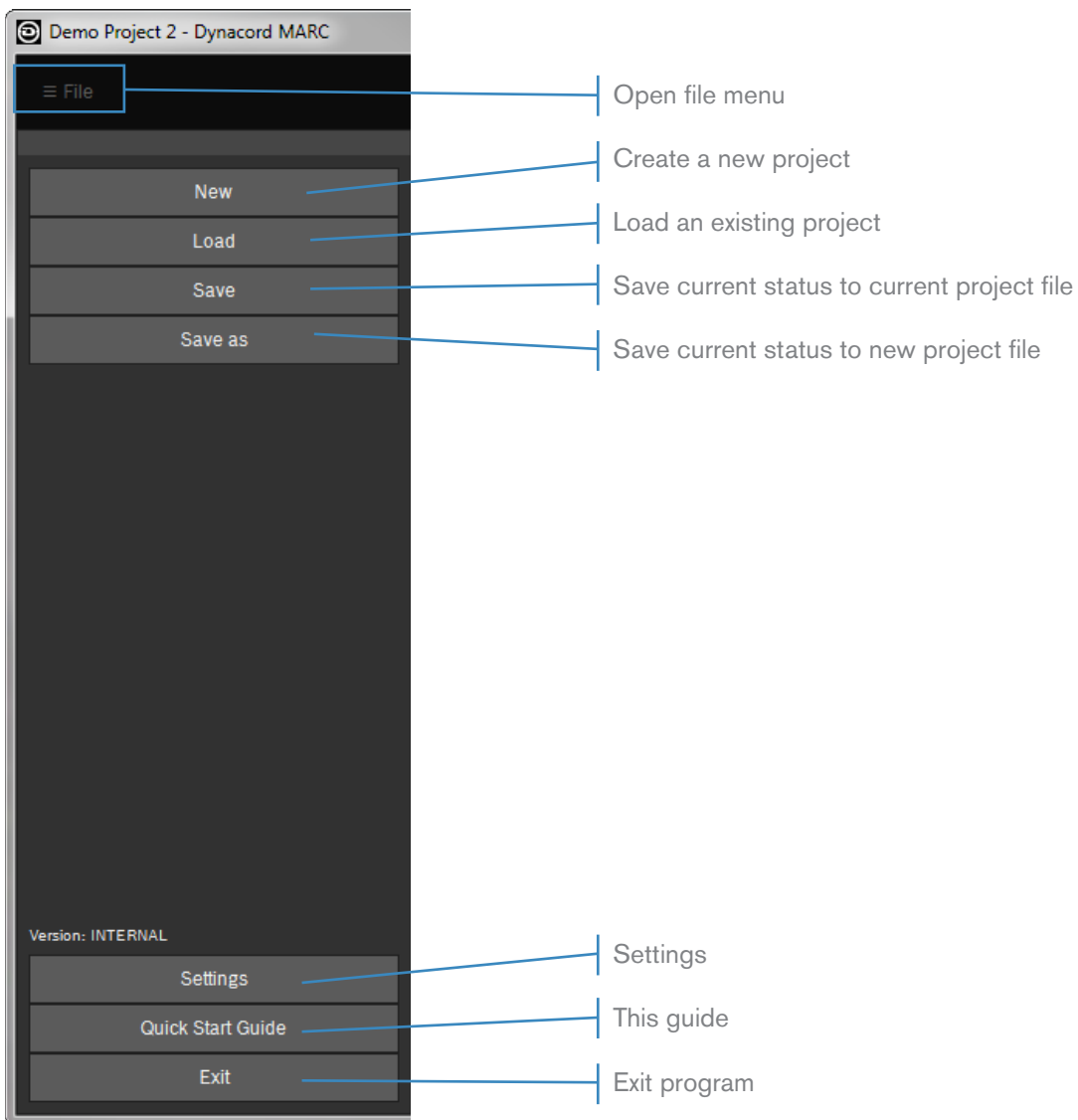

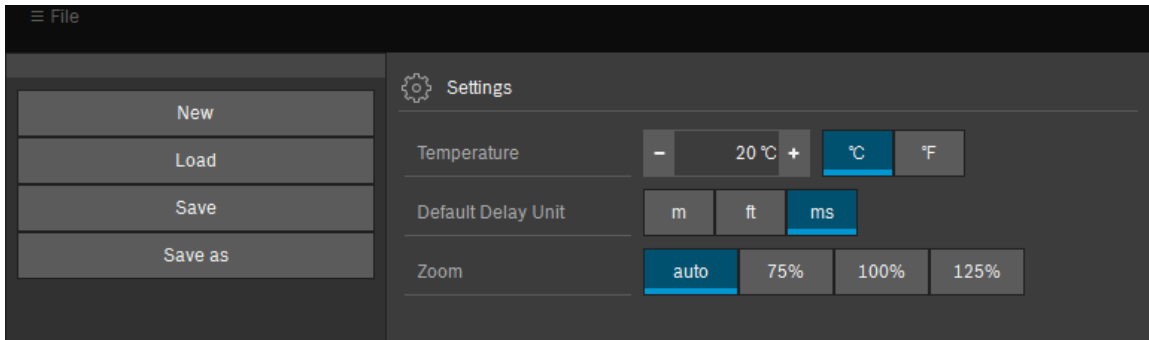

Settings will let you adjust temperature for delay calculation, default delay units and zoom factor (size) of the MARC program.

Firmware Update

The Multi Amplifier Remote Control (MARC) software package always includes the actual amplifier firmware version. Please check the corresponding ReadMe file for version numbers and details.

We recommend that you check the firmware version of your amplifiers and update it to the newest available firmware version. To update firmware start the software and:

1. Connect the amplifier to the computer via USB cable
2. Power on the amplifier - the amplifier will be automatically detected and show up in the field: "Amplifiers found via USB/ Network".
3. Click and hold the amplifier and move it over to the rack on the left side and release the mouse ("drag and drop") - the amplifier will now show with a yellow icon.
4. Go to the Amplifier tab in the top menu and select the amplifier (single click).
5. The amplifier details will now be displayed including the current firmware version.
6. On the bottom you will find the button: "Upload".
7. Press the button to upload new firmware to this amplifier
8. You will be prompted when the update has been finished. The new firmware version will be shown in the display of the amplifier page. During the firmware update the amplifier will power-cycle to reboot with the new firmware.

Firmware update will only work in offline mode. When you are online you can see the firmware version but not the option to update. We recommend to use a short USB cable directly connected to the amp without hubs and range extenders. You can connect multiple amplifiers at once but only update the firmware device by device.



DYNACORD

enjoy

working with your sound system driven by Dynacord's L or C series amplifiers with the Multi Amplifier Remote Control (MARC) software.

Bosch Sicherheitssysteme GmbH

Robert-Bosch-Ring 5

85630 Grasbrunn

Germany

www.dynacord.com

© Bosch Sicherheitssysteme GmbH 2017