



Google Hangouts Meet Certified Design Template

Large Meeting Room – Parlé Microphones TCM-X

This tech note shows how Biamp Tesira hardware and Google Hangouts Meet can be integrated to support a large meeting room space. In this document a large meeting room is defined as a meeting space about 15' x 28' (4.5M x 8.5M).

Equipment list

Below is the list of Biamp equipment used in this system configuration:

- 1 - TesiraFORTÉ AVB VT4
 - Audio DSP
- 1 - Tesira TCM-XA
 - Beamtracking ceiling microphone with 2-channel amplifier
- 1 - Tesira TCM-XEX
 - Beamtracking expansion ceiling microphone
- 1 - Tesira EX-UBT
 - USB connection to Google Hangouts Meet System
- 4 - Desono C-IC6
 - 6.5" ceiling mounted loudspeaker
- 1 – TesiraCONNECT TC-5
 - 5 port AVB expansion box

Other System Requirements:

- 1 - [Google Hangouts Meet Kit](#)
- 10 - Network cable (CAT5e or better) for inter-Biamp hardware connection
- 1 - Interconnect cables required for specified Google Hangouts Meet Kit
- 1 - Computer running the Biamp Room Deployment Tool

Optional: Connection to building LAN for remote AV device setup and monitoring

Equipment installation

The diagram below provides an example of typical installation locations for the required hardware and may vary based on room layout. The [Parlé Ceiling Microphone Calculator](#) and [Desono Speaker Calculator](#) have been created to assist with determining the proper microphone and speaker quantities and locations for a given space.

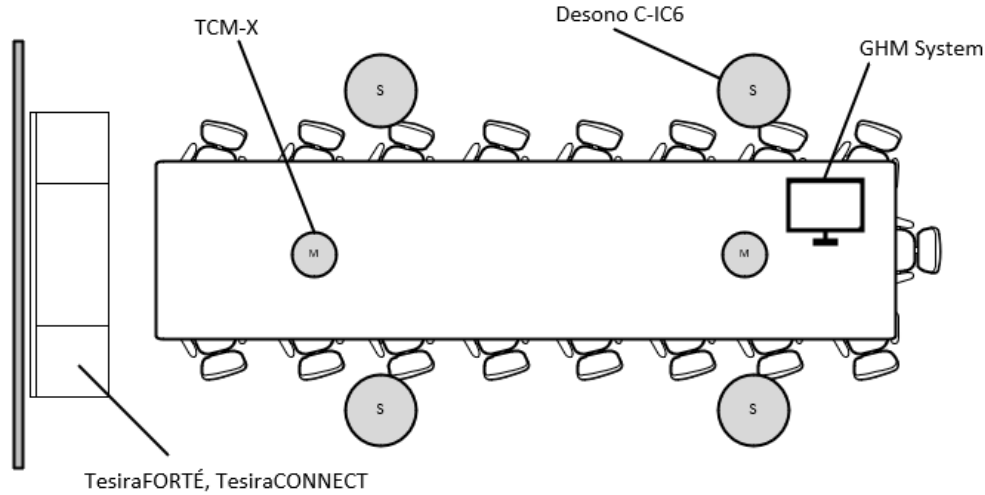

*It is recommended that a qualified AV integrator be utilized for installation and configuration of all hardware. For assistance locating an integrator, please contact Biamp Systems

Connect the hardware components as outlined in the diagram below.

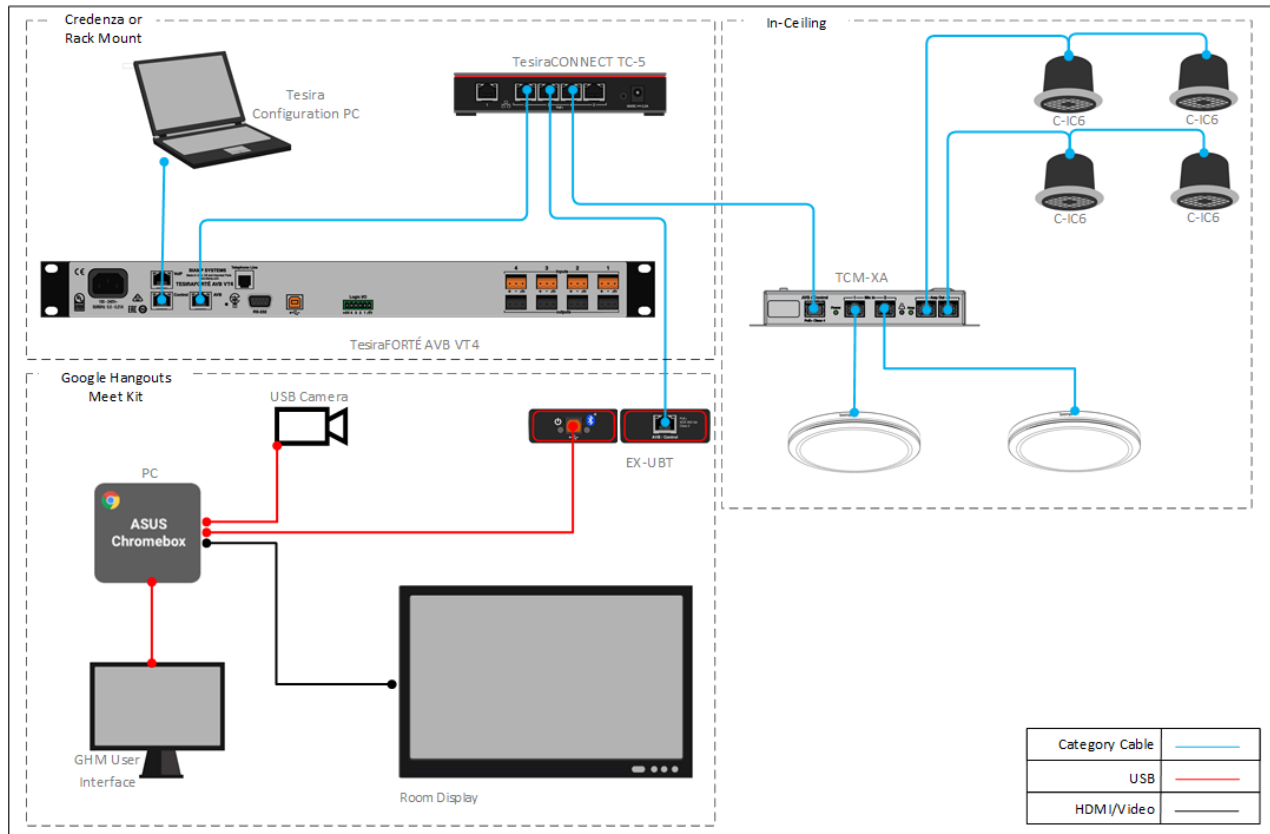



Installing the Configuration

The following sections will detail the configuration and setup of Tesira pro AV hardware with a Google Hangouts Meet system.

1. Unzip the downloaded package.



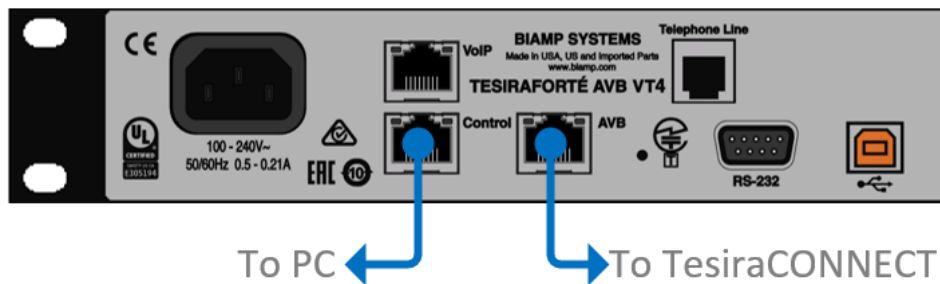

NOTE: All files will need to remain in the same directory they are extracted to for proper operation.

 TCM-X GHM Large Meeting Room  Compressed (zipped) Folder

2. Connect a computer directly to the control port of the TesiraFORTÉ AVB VT4.
 - a. The computer must have an IP address in the same subnet as the TesiraFORTÉ. The TesiraFORTÉ IP address can be verified on the front panel of the device.



3. Launch the Biamp Room Deployment Tool.

<input type="checkbox"/> Name	Type	Size
 Additional	File folder	
 Assemblies	File folder	
 eula	Adobe Acrobat D...	148 KB
<input checked="" type="checkbox"/>  RoomDeploymentTool	Application	437 KB
 RoomDeploymentTool.exe.config	CONFIG File	2 KB

4. Confirm device discovery
 - a. When launched, the Biamp Room Deployment Tool will automatically discover the connected devices and populate the Serial Number field.
 - b. If no device information is displayed, please verify the computer's IP address is in the same subnet as the TesiraFORTÉ by looking at the FORTÉ's front panel and **Rescan**.

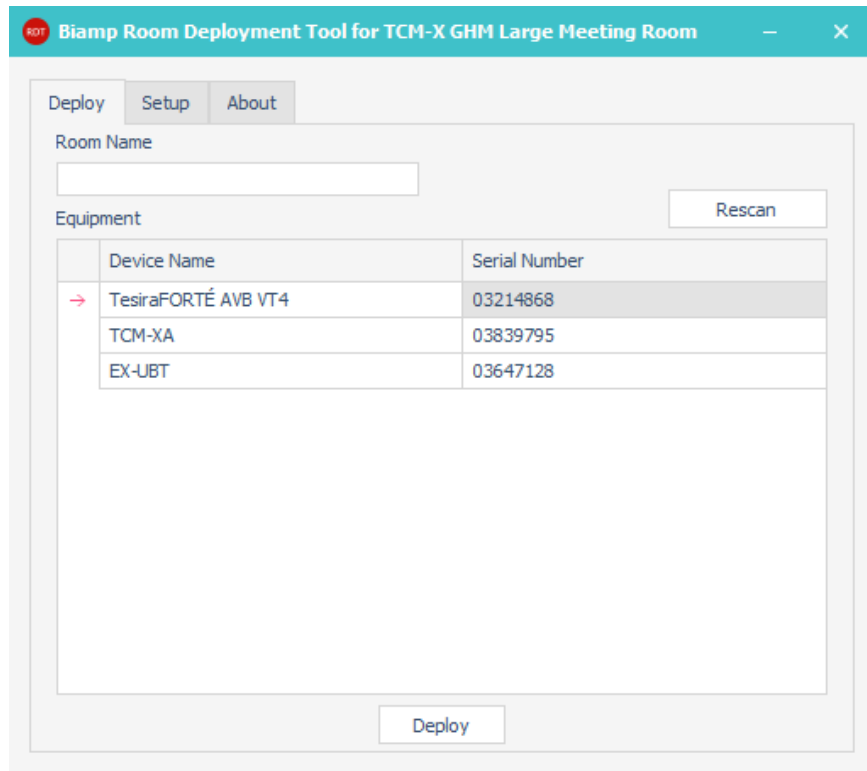

5. Enter a **Room Name** for this system.

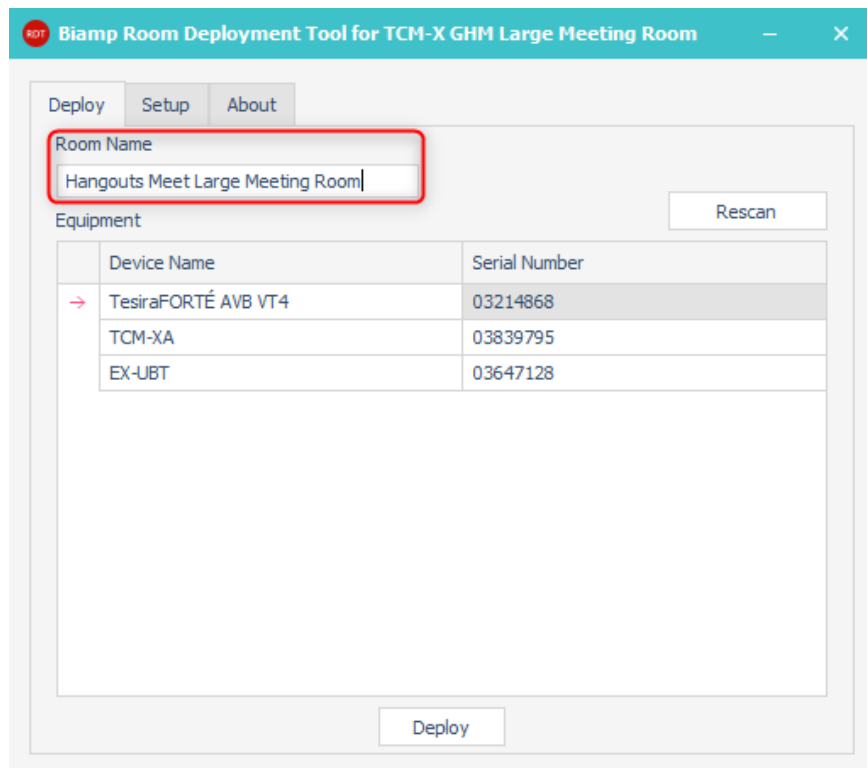

6. Click **Deploy**.

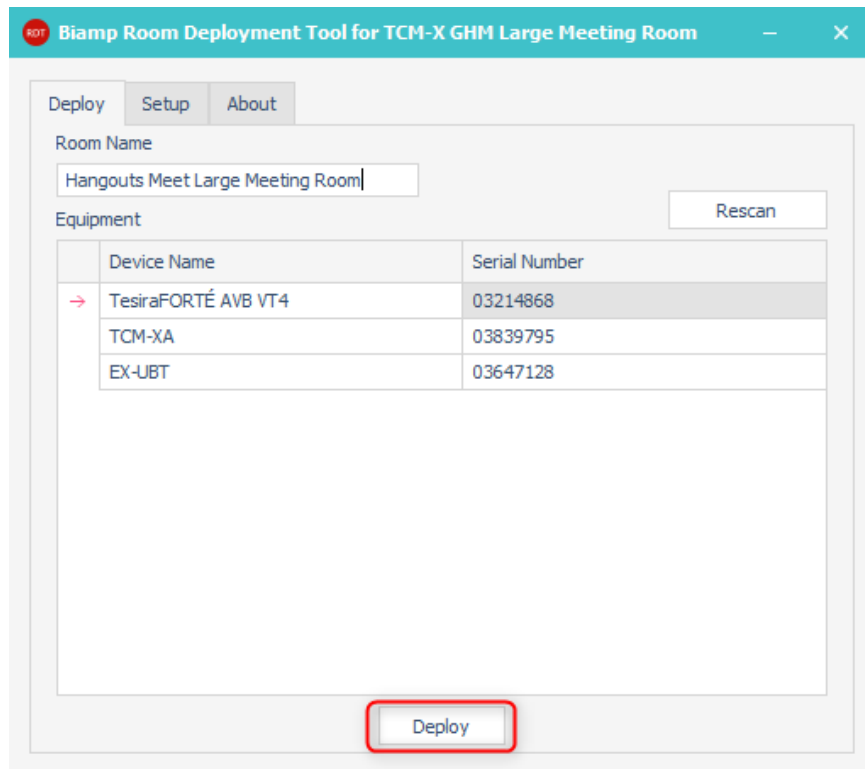

Setting the audio device from the Google Hangouts Meet User Interface

Setup and deployment of specific Google Hangouts Meet hardware may vary, please see manufacturer documentation for proper operation. The Biamp Tesira system enumerates as a USB audio peripheral device when connected to any Google Hangouts Meet room system.

1. Navigate to the **Settings** menu on the user interface.



- From the **Features** menu, use the dropdowns to select the EX-UBT.

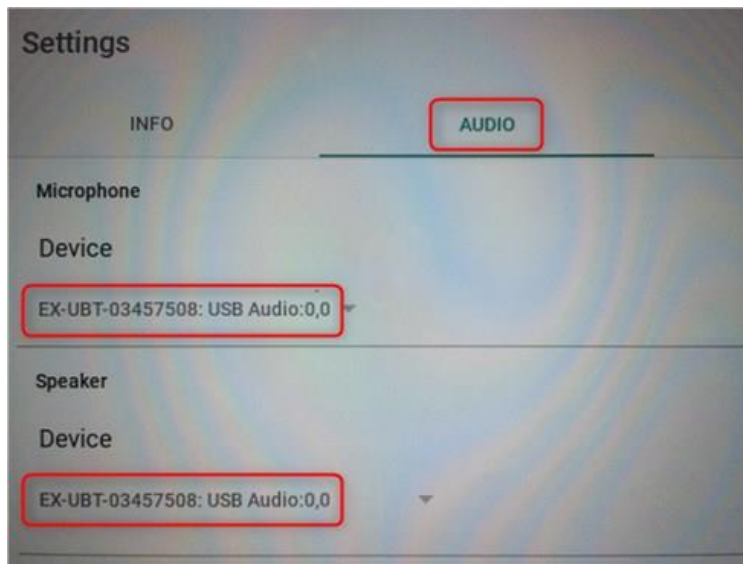

Testing and System Adjustments

The default settings within this configuration file will cover most scenarios. However, controls have been provided to adjust common settings. The following section will provide steps to verify and optimize performance. To start this process, join a meeting from the Google Hangouts Meet room system with a far end participant and navigate to the Setup tab of the Room Deployment Tool.

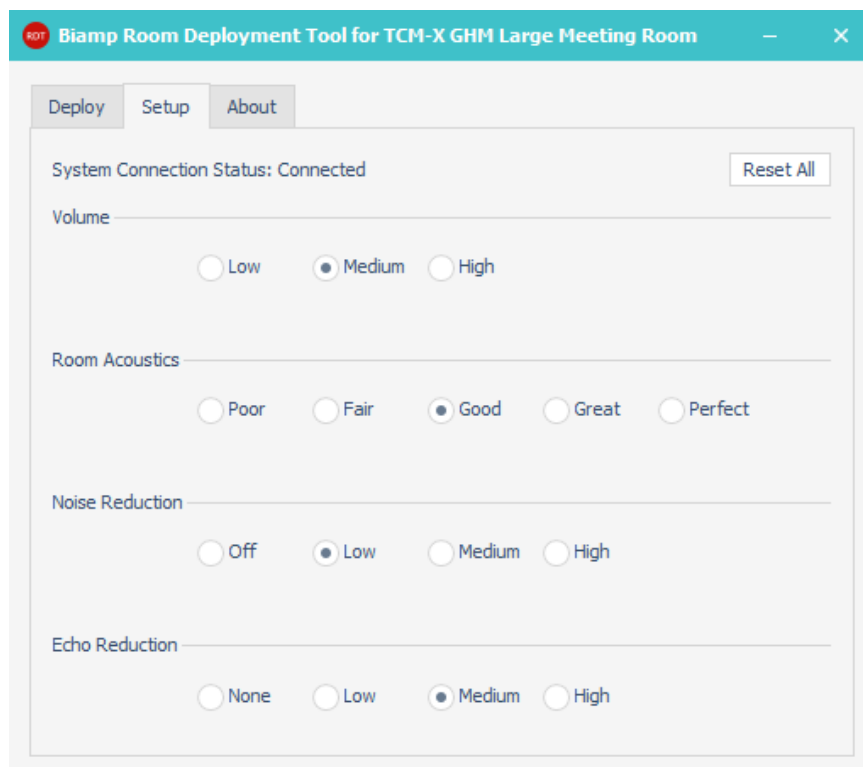

The following adjustment is made from inside the meeting room.

Setting the meeting start volume

The volume of the far end participant is controlled from the Google Hangouts Meet user interface. By default, the volume control will set to 60% when a meeting is started. The following steps are used to optimize the incoming far end volume at this default startup.

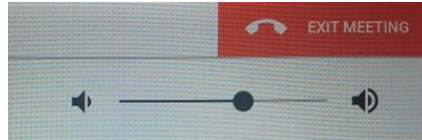

1. Navigate to the Volume section. The default setting is **Medium**.
2. Have the far end participant speak. If that volume is acceptable, proceed to the Equalization section.

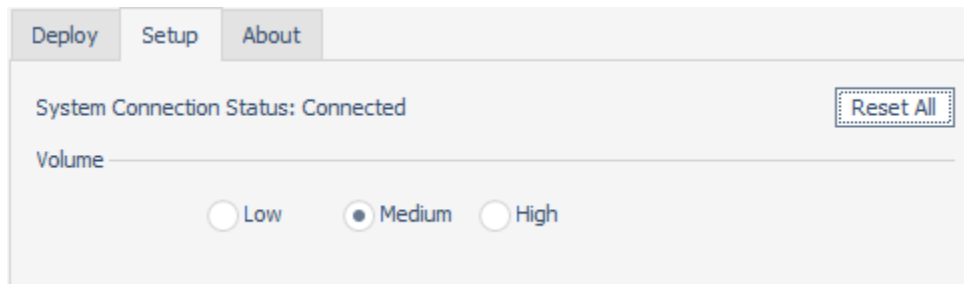

3. If the far end level is too quiet, select **High** and retest.
4. If the far end is too loud, select **Low** and retest.

The following adjustments are made from the far end of the meeting room.

Room Acoustics adjustments

Room Acoustics settings correspond to quality of the acoustical environment in which the TCM-X microphones are installed. These are identified by a range of Poor to Perfect. Each option will optimize the quality of the microphone signal being sent to the far end under the specific acoustic conditions.

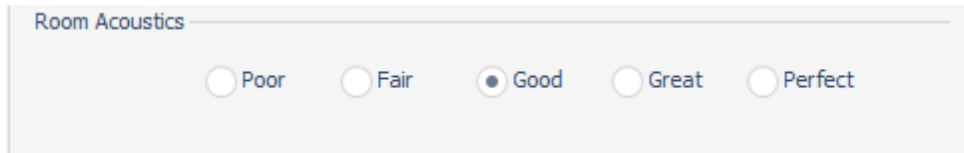

Two primary factors that identify which category a room may fall into are noise and reverb. Noise may come from sources such as HVAC or other building mechanical systems and can make it difficult for the far end to distinguish voices over the level of noise in a room. Rooms with many reflective surfaces such as conference room tables, windows, glass walls, or hard ceilings can sound reverberant and create intelligibility issues with the signal being sent to the far end.

For more information on the noise and reverb thresholds for each room setting, please refer to the following link – [Room Acoustics Setting](#). If measurements are not available for the room, use the following process.

1. Start at the default setting of **Good** and listen to the audio transmitting from the room to the far end. If this sounds acceptable, also test with **Great** and **Perfect**, using the highest setting that produces the desired results.

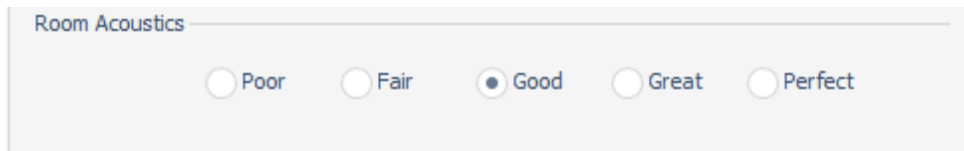

2. If **Good** is undesirable, test with **Fair** and **Poor**, again, using the highest setting that produces the desired results

Noise reduction adjustments

Noise Reduction (NR) is intended to reduce steady-state background noises, such as HVAC systems, fans, motors, or other mechanical devices that may be picked up by the conferencing microphones and transmitted to the far end.

1. If the default **Low** setting provides acceptable performance, proceed to the Echo Reduction section.

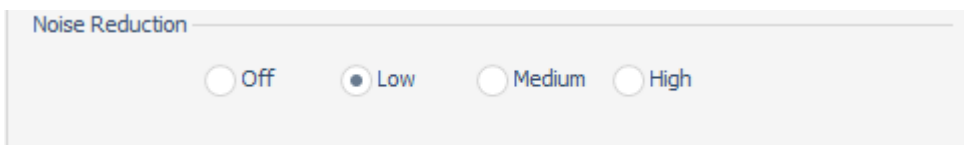

2. If background noise is undesirable, increase noise reduction to **Medium**.
3. If background noise is still undesirable, increase noise reduction to **High**. This should only be used in extreme situations.

Note: Set noise reduction to **Off** to hear the room with no reduction in place. This can provide a good reference on the amount of noise that is being removed from the signal.

Echo reduction adjustments

These echo adjustments can be used to eliminate any residual echo that may be heard by the far end participants while speaking. The lowest setting that produces acceptable results should be used.

1. With the default **Medium** setting selected, speak from the far end and listen for any words or portions of words that are echoed back.

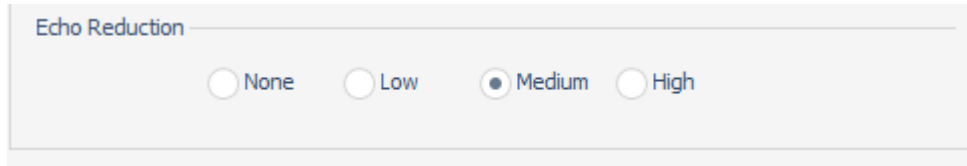

2. If no echo is heard at **Medium**, retest with **Low** and **None**, using the lowest acceptable setting.
3. If echo is heard at **Medium** select **High** and retest. If echo is still heard at High it is possible that room acoustics are not optimal, or the ceiling microphones are installed too close to the ceiling loudspeakers. Additional room tuning or installation changes beyond the capabilities of this tool may be required. Contact your Biamp dealer and/or certified Tesira programmer if this is the case.

Note: An Echo Reduction setting of **Low** is typically the lowest setting that will be used; however, testing with this set to **None** can provide a good reference for the effect that NLP (non-linear processing) is having on the signal.

After running through the Noise and Echo adjustments, it can be helpful to revisit the Room Acoustics adjustments and audition the impact that these three settings have on each other.

Appendix

HID communication logic

The EX-UBT synchronizes privacy mute state and volume control with Google Hangouts Meet. This is achieved through Human Interface Device (HID) communication.

When audio is muted from the user interface, the ceiling mic LEDs will change red to indicate this muted state. Unmuting from the user interface will return the LEDs to green.

The LEDs on the TCM-X ceiling microphone will light when a USB connection is made to an active host. This can be used as a troubleshooting tool. If the LEDs are not lit, please check the USB connection and ensure that the EX-UBT has been selected as the Microphone and Speaker for Conferencing from within the Google Hangouts Meet settings menu.

Networking details

This system deployment use of [PoE+](#) powered endpoints. The TesiraCONNECT provides all necessary resources to support these communications.

- The TesiraCONNECT TC-5 requires no configuration to support device communications and will provide all necessary power to PoE powered devices.
- A standard network cable (Cat5 or higher) to connect the TCM-X microphones with the plenum box
 - Do not exceed 33ft or 10m on this link
 - This is a proprietary digital audio link, not compatible with Ethernet
- Note that the TesiraFORTE is the only device that will require an IP address and is set to DHCP by default.

Microphone and speaker placement

Microphone placement

Even though the TCM-X beamtracking microphones use state of the art technology to track a person's voice, while reducing unwanted background noise, the laws of physics can't be ignored when deciding on the right placement of a microphone. A good signal-to-noise ratio is key in every part of the audio signal chain and for a typical microphone pickup scenario, this translates to avoiding large distances between the mic and the talker.

- Keep the distance to the talker as short as possible.
- Keep the distance to the ceiling speakers as high as possible.
- Stay away from noise sources like projector fans and air vents.

Parlé Ceiling Microphone Calculator

The [Parlé Calculator](#) can be used as design and estimation tool for determining the number of microphones needed for a given space. Audio recordings have also been provided that allow you to listen to the performance of the microphone under a given set of acoustical conditions.

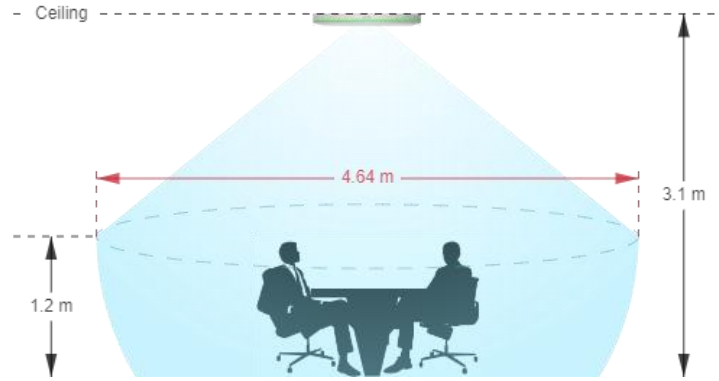

Speaker placement

Placing speakers in a room can be as equally critical as finding the right spot for a microphone. An ideal positioning of multiple ceiling speakers will achieve an even SPL coverage and a good speech intelligibility across the entire room.

Desono Speaker Calculator

The [Desono speaker calculator](#) can aid in determining the correct number and proper location in which the ceiling speakers should be located.

