

PREZONE2

Installation & Operation Guide



PRODUCT DESCRIPTION

The PREZONE2 is a professional audio device designed to accept audio signals from multiple sources and supply two distinct zones of audio outputs from these sources. The device may be controlled from the front panel user interface, wall control panels, Ethernet capable devices with a web browser, or an external control system using RS232.

FEATURES

- Emergency Input
- 2 Mono Mic/Line Inputs
- 2 Stereo Output Zones
- 2 Zone Selective Paging Input with Chime
- 4 Stereo Line Inputs
- Wall Panel Control
- Auto Standby
- Ethernet and RS232
- Control Priority Output
- Includes Adhesive Labels for Zone & Source Identification
- Webapp Control
- CE marked, UL listed and RoHS compliant

IMPORTANT SAFETY / COMPLIANCE INFO

 Class 2 wiring: to reduce the risk of electric shock, the external wiring connected to the terminals marked with “class 2 wiring” requires installation of class 2 wiring by an authorized/trained person or by using ready-made leads or cords.

 This unit has NOT been designed for use in mobile applications, such as: mobile discobars, mobile PA systems, live bands and audio rental systems. Using it in such applications will lead to product damage and safety risks.

 Do not remove or defeat the ground prong on the power cord, as this will constitute a shock hazard. Equipment should be connected to a mains socket outlet with a protective earthing connection. This plug is the main disconnecting device and should remain readily operable. There are no user interchangeable parts. Please contact Biamp Technical Support or your local distributor for all service requirements.

Further safety and compliance information may be found at:

www.biamp.com/compliance

Warranty information may be found at:

www.biamp.com/legal/warranty-information



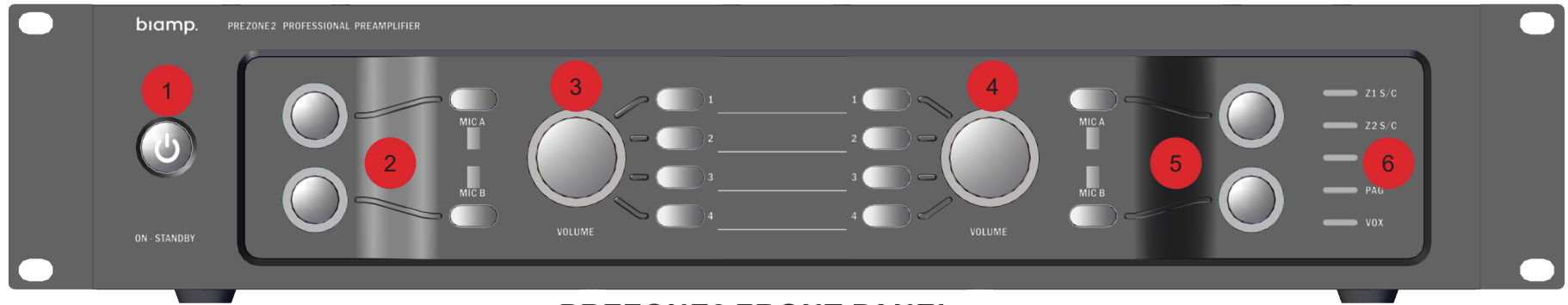

PREZONE2 FRONT PANEL

PREZONE2 Front Panel Controls

The PREZONE2 front panel features a power/standby button, controls for two distinct zones of audio outputs and an array of LEDs that give status of numerous functions of the device. Rotary encoders (volume controls) feature LED indication of the actual volume level. Adhesive labels may be applied to indicate zone sources and outputs.

1. Standby

Initiates or disables manual standby mode. Indicates status of standby mode.

2. Zone 1 Volume Control

Rotary volume controls and mute button for microphones A/B in Zone 1

3. Zone 1 Input Source Selection & Volume Control

Rotary volume control for 4 audio input source selection in Zone 1. User-defined labels for audio source and output.

4. Zone 2 Input Source Selection & Volume Control

Rotary volume control for 4 audio input source selection in Zone 2. User-defined labels for audio source and output.

5. Zone 2 Volume Control

Rotary volume controls and mute button for microphones A/B in Zone 2

6. LED Status Indicators

LED	DESCRIPTION	GREEN	ORANGE	RED
S/C Z1	Zone 1 Signal Present/ Clip	Signal Present	N/A	Clipping Condition Present
S/C Z2	Zone 2 Signal Present/ Clip	Signal Present	N/A	Clipping Condition Present
EMG	Emergency Mode	N/A	Active	N/A
PAG	Paging Mode	Active	N/A	N/A
VOX	Mic A VOX Override Active	Active	N/A	N/A

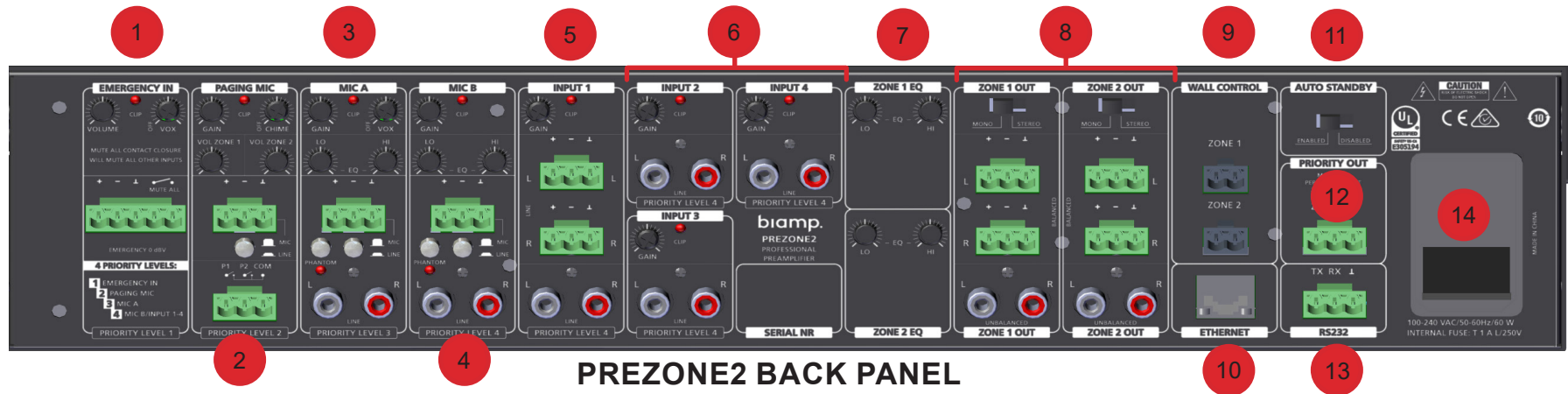

PREZONE2 BACK PANEL

PREZONE2 Back Panel Connections

The back panel features numerous inputs and outputs as well as equalizers for both zones, connections for wall controllers, Ethernet and RS232. All inputs are designated by priority level (1 - 4). For specific instructions on controls, connections and wiring, see "Back Panel Wiring and Connections" on page 5.

1. Emergency Input

The Emergency Input has the highest priority level of the inputs and will mute all other audio when active.

When the emergency mode is active, it is indicated by the front panel LED (EMG), the EMG indicator on the webapp and a RS232 notification. Activating the emergency input will disable standby mode and activate the priority output for both zones.

The emergency input may be activated by a contact closure or an audio signal that exceeds the VOX threshold level. If an audio signal is applied and VOX mode active, it will also be sent to both audio zones.

2. Paging Mic Input

The Paging Mic input has the 2nd highest priority of all inputs. Paging is zone-specific and each zone may be paged independently or simultaneously. Paging overrides all audio in the active zones except the Emergency Input.

A paging chime may be set to activate prior to the paging mic being active.

Paging mic status is indicated by front panel LED (PAG), the PAG indicator on the webapp and a RS232 notification. Activating the paging mode will also activate the priority output of the selected zone(s).

3. MIC A Input

MIC A input has the 3rd highest* priority of all inputs. The input connection accepts a balanced microphone or line level audio signal via the Euroblock connector and a stereo line level via RCA connectors. A pushbutton allows switching between MIC and LINE (Euroblock).

NOTE: MIC A priority level may be disabled by turning the VOX level to the OFF position. If disabled, MIC A is summed with the MIC B / Line Inputs.

The RCA input is stereo, but a mono sum will be fed to the stereo zone output.

GAIN and HI LO EQ may be adjusted via control knobs. An LED indicates any clipping condition.

Phantom power (48 V) may be applied to the balanced Euroblock via the phantom power pushbutton switch.

VOX, when activated, will attenuate all lower priority sources (MIC B and Inputs 1-4) by 30 dB.

4. MIC B Input

MIC B input has the 4th (lowest) priority of all inputs. The input connection accepts a balanced microphone or line level audio signal via the Euroblock connector and a stereo line level via RCA connectors. A pushbutton allows switching between MIC and LINE (Euroblock).

The RCA input is stereo, but a mono sum will be fed to the stereo zone output.

GAIN and HI LO EQ may be adjusted via control knobs. An LED indicates any clipping condition.

Phantom power (48 V) may be applied to the balanced Euroblock via the phantom power pushbutton switch.

5. Input 1

The input connection accepts a balanced microphone or line level audio signal via the Euroblock connector and a stereo line level via RCA connectors.

Gain may be adjusted via a control knob. An LED indicates any clipping condition.

Both input connections may be used at the same time and will be summed together.

6. Input 2-4

These input connections accept stereo inputs using unbalanced RCA connectors.

Gain may be adjusted via a control knob. An LED indicates any clipping condition.

7. Zone 1&2 EQ

Audio equalization (HI and LO tone controls) for Zone 1 and 2 outputs.

8. Zone 1&2 OUT

Stereo audio output for zones 1 and 2. The mono/stereo switch allows the output to be configured as a mono or stereo output. Balanced Euroblock and unbalanced RCA connectors are available and active at the same time.

9. Wall Control

Allows connecting two DIWAC or D-DIWAC wall panels, one for each zone, to allow control of source selection and volume control for each zone.

10. Ethernet

RJ45 connector that allows Ethernet access, control and configuration. This may be connected to a network or an individual device using standard CAT5e (or better) cable.

11. Auto Standby

Enables/Disables auto standby mode.

12. Priority Out

3-pin Euroblock connector with two 24 VDC priority signals. Active when either the Emergency Input or Paging is active to the zone connected. Overrides external volume controls present on speaker lines so emergency or paging messages are audible, regardless of physical volume control status.

13. RS232

3-Pin Euroblock connector that allows the PREZONE2 to be controlled from an external device.

14. Main Power Input Switch & Fuse

3-prong mains power cord connection, power on/off switch and mains fuse (T1AL/250V glass tube).

Installation and Connections

The PREZONE2 may be rack-mounted (requires 2RU of rackspace) or placed on a flat surface to meet design/space requirements as needed.

For rack-mounting, the PREZONE2 comes with two removable rack-ears (Figure 1).

For surface mounting, the PREZONE2 is equipped with removable rubber feet.

When installing in a rack, always install the lower attachment hardware first to avoid damaging equipment.

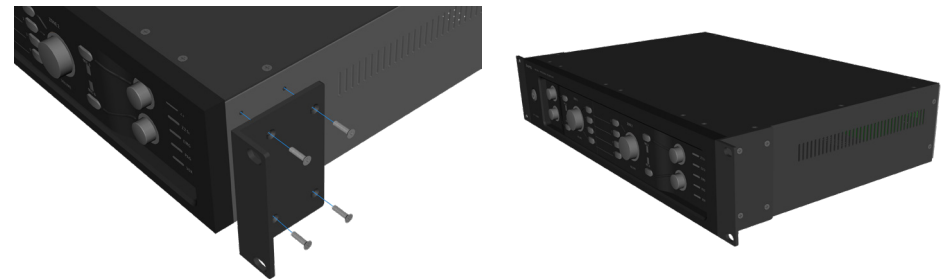

Figure 1. Rack Ear Installation

CAUTION

Operating temperature range of the PREZONE2 is -4° F to 104° F (-20° C to 40° C). Be aware of conditions in an enclosed rack that may cause the temperature to exceed ambient room conditions.

NOTE: When installing in a rack space, leaving a 1/2 rack gap at top and bottom of the unit will help ensure adequate ventilation and prevent overheating.

Back Panel Wiring and Connections

The section that follows gives information about wiring/connecting and operation of select inputs and outputs on the back panel.

Wiring - Emergency Input

1. See Figure 2. Connect a balanced 0 dBV line level emergency input audio signal to the Euroblock connector.
2. If available, connect the emergency contact to the "mute all" connection. The contact must be "potential free" (a relay or switch contact that does not carry any voltage.)
3. Alternatively, activate the VOX circuitry by turning the VOX control until there is an audible "click".
4. Turn the VOX control up while playing music until the VOX circuit is activated. The VOX and the 'mute all' switch have the same function: they will mute all other sources and "wake" the unit from standby (auto standby and manual button standby).
5. The emergency level can be set with the volume control.
6. Lower the level of the emergency signal at the source to avoid distortion if the clip LED illuminates when the emergency signal is present.

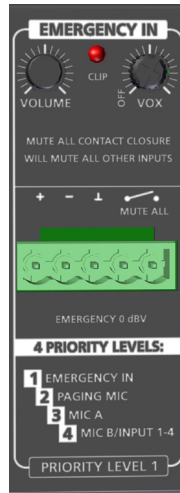

Figure 2. Emergency Input

Wiring - Paging Mic Input

1. See Figure 3. Connect the microphone - the Euroblock accepts balanced microphone or line level signals.
2. Set the MIC / LINE switch accordingly.
3. Adjust the gain control so the clip LED does not illuminate when the signal is at the highest level.
4. Adjust zone volume controls as required.
5. When paging is active, all other sources except Emergency Input are muted.

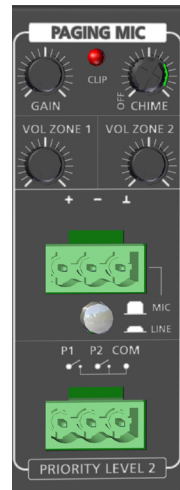

Figure 3. Paging Mic

6. If the Chime level is set to OFF, the paging mic will be live immediately upon activation. Otherwise the chime will play in the selected zone(s) at the volume set prior to the mic going live.

Wiring - MICPAT-2 & MICPAT-D to Paging Mic Input

If connecting a MICPAT-2 paging station to a PREZONE2, users may send paging messages to both zones, either together or independently.

MICPAT-2 Wiring

1. Connect the MICPAT-2 to the PREZONE2 as shown in Figure 4a.
2. The MIC/LINE switch is typically set to LINE, however it may be set to MIC for greater sensitivity, but take care to avoid clipping.

If connecting a MICPAT-D paging station to a PREZONE2, users may send paging messages to both zones together.

MICPAT-D Wiring

1. Connect the MICPAT-D to the PREZONE2 as shown in Figure 4b.
2. The MIC/LINE switch is typically set to LINE, however it may be set to MIC for greater sensitivity, but take care to avoid clipping.

NOTE: Refer to the appropriate MICPAT manual for further details on set up and use of the paging stations.

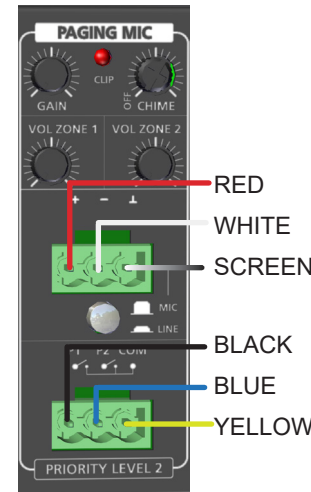

Figure 4a. MICPAT-2 Wiring

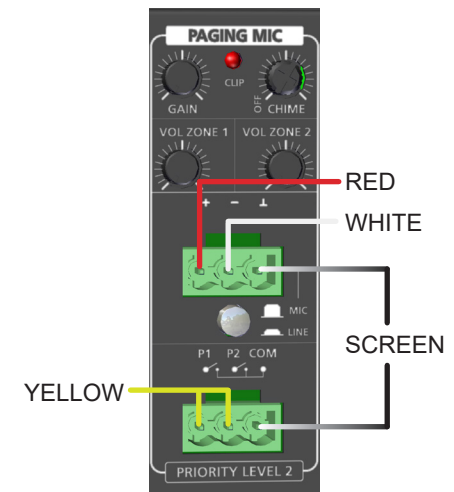

Figure 4b. MICPAT-D Wiring

Wiring - MIC A Input/MIC B Input

1. See Figure 5. Connect the microphone - the Euroblock accepts balanced microphone or line level signals; the RCA jacks accept line level signals.
2. Set the MIC/LINE switch accordingly.
NOTE: if the balanced input is left open, LINE should be selected to eliminate input noise.
3. The stereo unbalanced input signals are mono, summed and merged with the balanced input into one signal which may be sent to all zone outputs.
4. Phantom power (48 V) may be applied to the balanced Euroblock by pushing the phantom power switch.
5. Adjust the gain control so the clip LED does not illuminate when the signal is at the highest level.
6. Adjust EQ as needed.
7. If necessary, activate the VOX circuitry by turning the VOX level control until there is an audible “click” (*MIC A Input only*).
8. When activated, the VOX circuit will attenuate all lower priority sources (MIC B, Input 1-4) by 30 dB in the zone(s) where MIC A is enabled.
9. Volume may be set using the front panel level control. MIC Input A or B may be activated by pressing the respective MIC A or B select switch on the front panel.



Figure 5. Mic A & B

Wiring - Inputs 1-4

1. See Figure 6. Connect source inputs as required. Input 1 has Euroblock connectors that accept balanced line level signals and RCA jacks that accept line level signals. Inputs 2-4 accept RCA only. Inputs 2-4 accept RCA only.

NOTE: the balanced and unbalanced signals are summed, while keeping the stereo signal. Both inputs (Input 1) may be used at the same time.

2. Adjust the gain control so the clip LEDs do not illuminate when the signal is at the highest level.

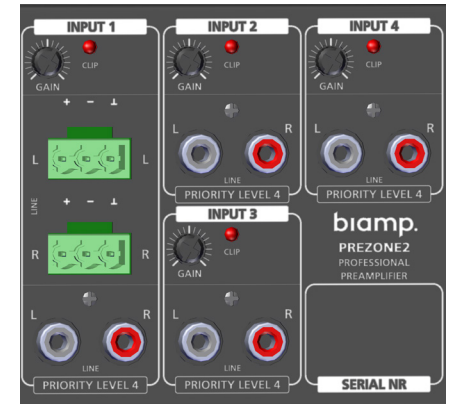

Figure 6. Inputs 1 - 4

Wiring and EQ - Zones 1 and 2

1. See Figure 7. Connect stereo outputs to either the balanced Euroblock or unbalanced RCA connectors for Zones 1 or 2. Stereo or Mono may be selected.
2. LO and HI tone controls may be adjusted via EQ knobs for either zone.

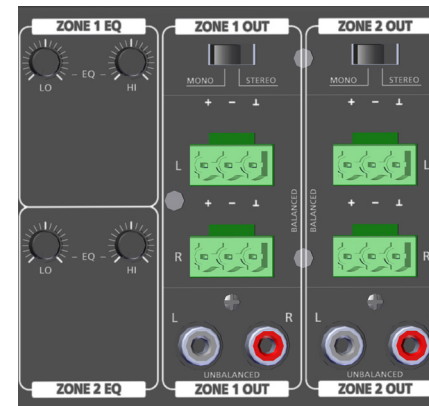

Figure 7. Zone Outputs & EQ

Back Panel Wiring and Connections (continued)

Wiring - D-DIWAC and DIWAC Wall Controls

1. The PREZONE2 is compatible with the D-DIWAC and DIWAC wall controls. Connect wall controls from the appropriate zones via connectors on the back panel as shown in Figure 8.
2. The maximum cable length per wall control is 1640 ft. (500m) using CAT6 cable (half the conductors used at each pin of the connector) or 16 AWG, 2 Conductor (16/2) loudspeaker cable.
3. Volume and audio source selection may be controlled independently for Zones 1 and 2 via the wall controllers. Only one wall control panel may be connected per zone.

NOTE: Data and power are carried across both wire connections, therefore there is no specific polarity on the 2-pin Euroblock connectors.

Wiring - Ethernet

1. See Figure 8. Connect the PREZONE2 to a network via a router or directly to an individual device with CAT5e or better cable.
2. Once connected, users have several options to access a fully-responsive webapp to operate the PREZONE2. See "Network Connections" for more information on network configuration and accessing the webapp control page.



Figure 8. Wall Control & Ethernet

Wiring - Priority Out

1. See Figure 9. Connect the 3-pin Euroblock to the override relay in any line-in volume controls wired in the loudspeaker line for Zones 1 and/or 2, as required.
2. These signals will become active when either the emergency system or paging is active to the zone controlled.
3. A priority signal overrides the external volume control so emergency/paging messages are heard, regardless of the physical state of the volume control.

NOTE: Do not use the priority output continually at full power.

Wiring - RS232

1. See Figure 9. Connect an external device to the PREZONE2 via the RS232 connection. RS232 serves as a text command interface with the following port parameters:
 - baud rate: 115200
 - 8 data bits
 - 1 stop bit
 - no parity
2. See "RS232 Control" for more information on using text command protocol with the PREZONE2.

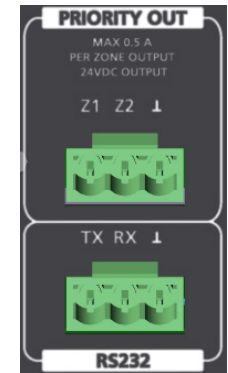

Figure 9. Priority Out & RS232

Back Panel Wiring and Connections (continued)

Standby Modes

The PREZONE2 has two standby modes: Manual and Auto.

Manual Standby Mode

If auto standby is set to DISABLED on the back panel, push the on/standby button to enter standby mode. When in standby mode, the front panel on/standby button will not be lit. The webapp will indicate the device is in standby mode and the displays of any connected DIWAC wall panels will turn off.

The device will exit standby mode if:

- Any front panel button is pushed
- Emergency Mode is activated
- The back power switch is cycled on/off (or mains power is otherwise interrupted)

NOTE: *the device will enter standby mode by pushing the front panel standby button, regardless of the auto standby setting.*

Auto Standby Mode

See Figure 10. If auto standby is set to ENABLED on the back panel, the PREZONE2 will enter standby if no audio is present (less than -40dB) on all selected inputs for 10 minutes. The device will not enter standby if Emergency or Paging modes are active.

When auto standby is active, the front panel On/Standby button LED will pulse on and off. Any connected DIWAC wall panels will indicate that auto standby is active.

The device will exit auto standby mode if:

- An audio signal above -40dB is applied to a previously-selected input
- Any front panel button is pushed (including the On/Standby button)
- A connected DIWAC wall panel button is pushed
- Emergency or Paging Mode is activated
- The back power switch is cycled on/off (or mains power is interrupted)
- An external SET command is received via RS232

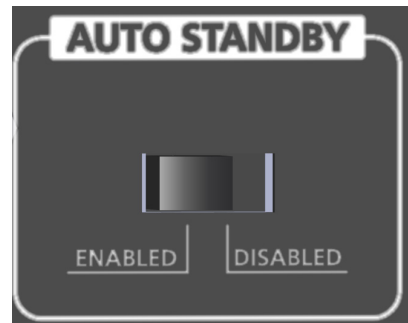

Figure 10. Auto Standby Switch

Network Connections

The PREZONE2 may be operated via the built-in webapp by connecting the PREZONE2 to a controlling device via a network connection.

The PREZONE2 will automatically obtain an IP address and configure. In a routed network, the PREZONE2 will obtain an IP address via DHCP. In a switch network or direct connection to a controlling device, the PREZONE2 will auto-generate a link-local address.

Factory default hostname is 'prezone2,' which may be changed in the webapp (connecting via hostname is the most reliable way to connect to the PREZONE2)

Further information on PREZONE2 connections and Zero Network Configurations can be found on support.biamp.com.

Connect to the Webapp via Switched or Routed Network

The PREZONE2 webapp may be accessed via PC/Laptop or mobile device, depending on the network configuration. PREZONE2 uses a standard called 'Zero Configuration Networking,' which allows the device to fully configure itself.

1. See Figures 11-13 for connection options. Use the configuration suitable to design and network requirements.
2. Once the PREZONE2 is connected in one of the configurations shown, open a web browser on a PC or mobile device and enter the hostname in the address bar.
 - a. Regardless of the connection type (wired/wireless), the controlling device must be on the same network infrastructure as the PREZONE2.
3. If a DNS server is available, enter the hostname in the browser as follows: "prezone2/". Press enter.
4. If no DNS server is available or the PREZONE2 is connected to a switched network, use mDNS to connect by entering the hostname in the browser bar as follows: "prezone2.local/". Press enter.
5. Another option to connect is by entering the IP address directly into the browser bar (use of a 3rd party application can be used to find the IP address).
6. The PREZONE2 webapp will now be available via the connected device. Multiple devices may connect to the PREZONE2 simultaneously.

NOTE: *Android devices do not allow ".local" searches from the browser. If using an Android device, use a local DNS server to resolve the hostname to the IP address. If no DNS server is available, enter the IP address directly into the web browser bar.*

Network Diagrams

The following diagrams give basic information about network connections.

Figure 11 shows a direct Ethernet connection from the PREZONE2 through the router to a PC. PREZONE2 will auto-configure and automatically obtain an IP address.

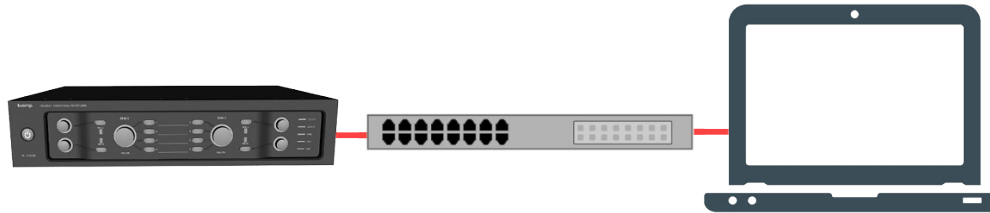

Figure 11. Direct Ethernet Connection via Router

Figure 12 shows a direct connection from the PREZONE2 through the router and wireless connections of various devices. PREZONE2 will auto-configure and automatically obtain an IP address.



Figure 12. WiFi Connection via Router

Figure 13 shows a direct connection from the PREZONE2 to a PC via Ethernet. This connection does not require any manual IP settings (link-local - both devices auto negotiate).

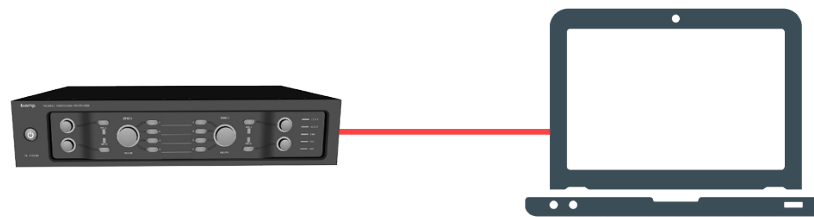

Figure 13. Direct Ethernet Connection

PREZONE2 Webapp

Once the PREZONE2 is connected to a network and is accessible via PC or mobile device, the webapp may be used to control features and functions of the PREZONE2. The primary components of the webapp are the control page and the settings page.

The table that follows gives device, operating system and browser combinations that have been tested and are supported. Other configurations not listed here are likely to function properly but have not been tested.

Device	Operating System	Web Browser
Windows PC	Windows 7 & 10	Chrome & Firefox
Android phone & tablet	Android 8, 9 & 10	Chrome & Firefox
iPhone, iPad & iPad Pro	iOS 12 & 13	Chrome & Safari

Note: Microsoft Edge is currently not supported.

Control Page

The Control page provides Zone, MIC and Source controls as well as status indications such as clipping, paging and emergency mode status.

See Figure 14 below for an example of the Control page:

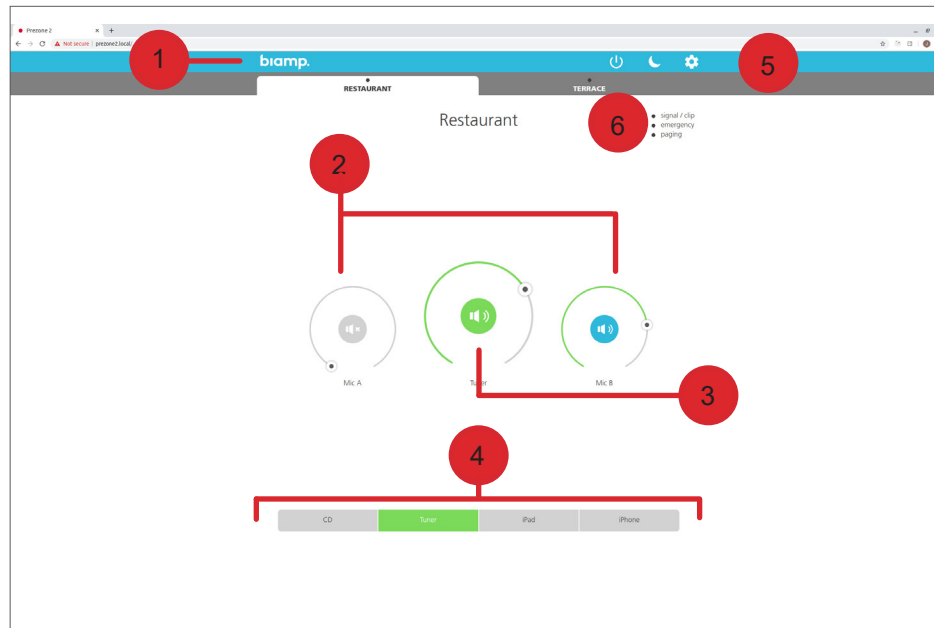

Figure 14. Webapp Settings Page

1. Zone Selection Tabs

The zone selection tabs enable control of either Zone 1 or 2. Both zone tabs have controls for mic volume, source selection and volume and give status of clipping, paging and emergency mode status.

2. MIC A and B Controls

The MIC A and B rotary dials control the level of the respective microphone input of the zone selected. The loudspeaker icon in the middle of the dial turns the microphone on or off.

3. Line Level Control

This rotary level control adjusts the volume of the selected source. The loudspeaker icon in the middle of the dial turns the source audio on or off.

4. Line Source Selection

Allows selecting the input for the current zone; only one source may be selected at a time.

5. Power, Night Mode and Settings

- Power Button - puts the PREZONE2 in Standby Mode.
- Night Mode - changes the color scheme so the PREZONE2 display is more suitable (dimmer) for dark locations.
- Settings - enters the settings page. See "Settings Page" for information.

6. Status Indicators

- Signal / Clip - illuminated green when a signal is present; illuminated red when the signal is clipping in the selected zone.
- Paging - illuminated green when a paging announcement is active in the selected zone.
- Emergency - illuminated green when emergency mode is active

LEDs on the front panel will reflect the level, selection and status in the webapp and vice-versa. For example, when adjusting the volume control for Zone 1 in the webapp, the LED around the Zone 1 knob will adjust accordingly.

PREZONE2 Webapp (continued)

Settings Page

The Settings page is accessed by clicking the gear icon at the top of the Control page. Users are presented with the screen shown in Figure 15.

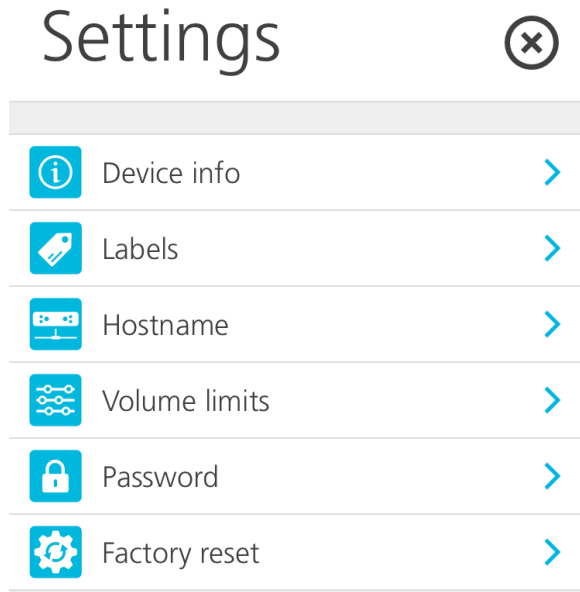

Figure 15. Webapp Settings Page

1. Device Info
 - Gives general device information like device name, hostname, IP address, software version, serial number and MAC address.
2. Labels
 - Allows editing the names of each zone, microphone or input from their default value. Letters, numbers, hyphens and spaces are allowed (ASCII character set).
3. Hostname
 - Allows changing the hostname by changing the device name. Note that identical hostnames on a local network are not allowed; if a conflict is present, the hostname will automatically be appended with '-a' or '-b' etc., until the conflict is resolved. Therefore it is possible the device name and hostname may not match.
4. Volume Limits
 - Allows adjusting minimum and maximum level controls for MIC A, MIC B and Line music levels for each zone via a volume limit slider. There must be a minimum 10% difference between the minimum and maximum volume levels.
5. Password
 - A password can be added to limit access to the settings page.
6. Factory Reset
 - This allows a full factory reset of the device. All settings will be erased and returned to the factory default settings and the device will automatically restart when performing a factory reset.

NOTE: A factory reset may also be accomplished via RS232 command and a button sequence. See *Factory Reset* for more information.

Factory Reset

Resetting the PREZONE2 to its factory default settings may be accomplished via the webapp as described previously, an RS232 command, or by the button sequence that follows:

Power on the device while holding the following buttons:

- MIC A Selection Zone 1
- MIC B Selection Zone 1
- Front Standby Button

A factory reset will occur when the buttons are released (the device will reboot).

RS232 Control

The RS232 control port allows controlling the PREZONE2 via an external device using text command protocol.

The protocol uses SET and GET as the first part of the command structure. SET may be used to change values in the device while GET may be used to gather information about the device.

GET and SET must be followed by details of the items to be controlled or queried. Basic rules and tips for successful RS232 communication are below. <CR> indicates a carriage return.

- A valid command is always answered with Ok <CR> <LF>
- An invalid command is always answered with ERROR <CR> <LF>
- All commands must end with <CR>, <LF> or <CR> <LF> depending on the controlling device and program being used.
- Only ASCII characters are allowed (UTF-8 is not supported).
- Keywords are *not* case-sensitive.
- The commanding device must wait for a response (Ok <CR> <LF> or Error <CR> <LF>) before sending a command that changes the same setting.

Test Command Examples

Text Command	Action/Response
set zone 2 selected input 3 <CR>	Selects a source in Zone 2
set zone 1 input volume 60 <CR>	Changes the audio level in Zone 1
set zone all mica inc volume 5 <CR>	Increments the MIC A level in both zones
get zone 2 micb onoff <CR>	Checks the status of MIC B in Zone 2. Response will indicate if the mic is on or off.
get system info <CR>	Gets all settings of the PREZONE2. Response will be a list of all current device settings and other info.

Notifications

External devices will receive PREZONE2 state notifications via RS232. If a device parameter changes, a message will be sent out over RS232 to the external device. This can be a volume update or a signal / clip LED change. These notifications are normal ASCII text and are similar to the text commands except they do not contain the SET or GET keyword. All notifications will end with <CR> <LF>.

Using the notifications is highly recommended over polling the PREZONE2 from the external device via get messages.

Figure 16 gives possible text commands. By following the connections from the left to right, valid commands may be created.

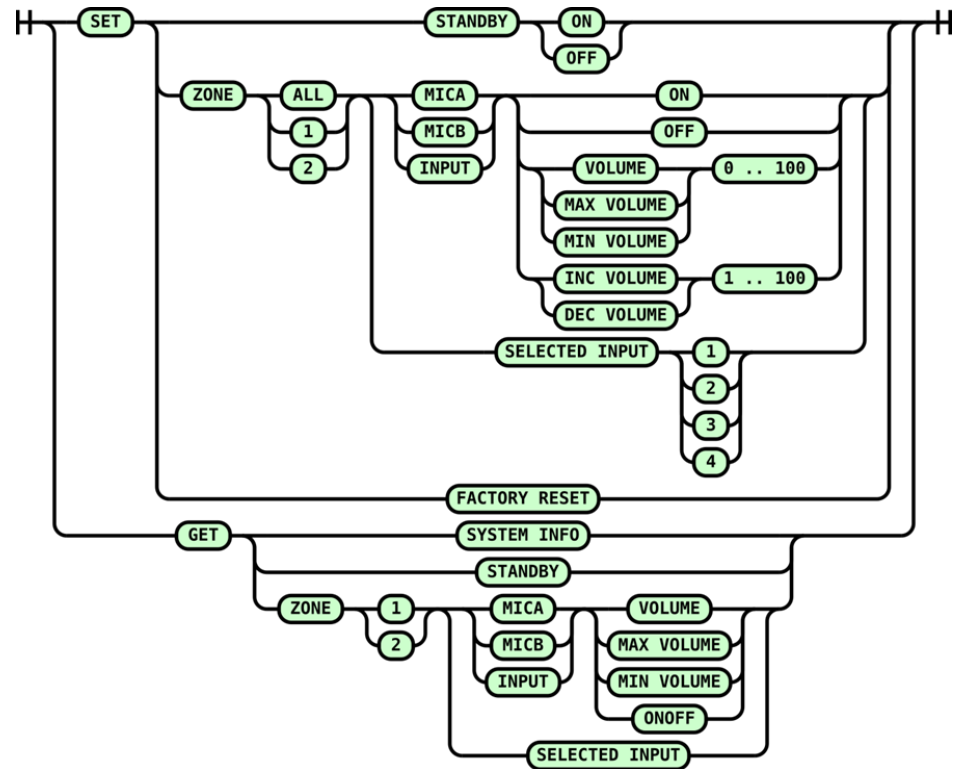

Figure 16. RS232 Text Command Diagram

PREZONE2 Block Diagram

Figure 17, below gives a signal flow block diagram of the PREZONE2. The key at the bottom right shows which blocks are located on the front and back panels, respectively.

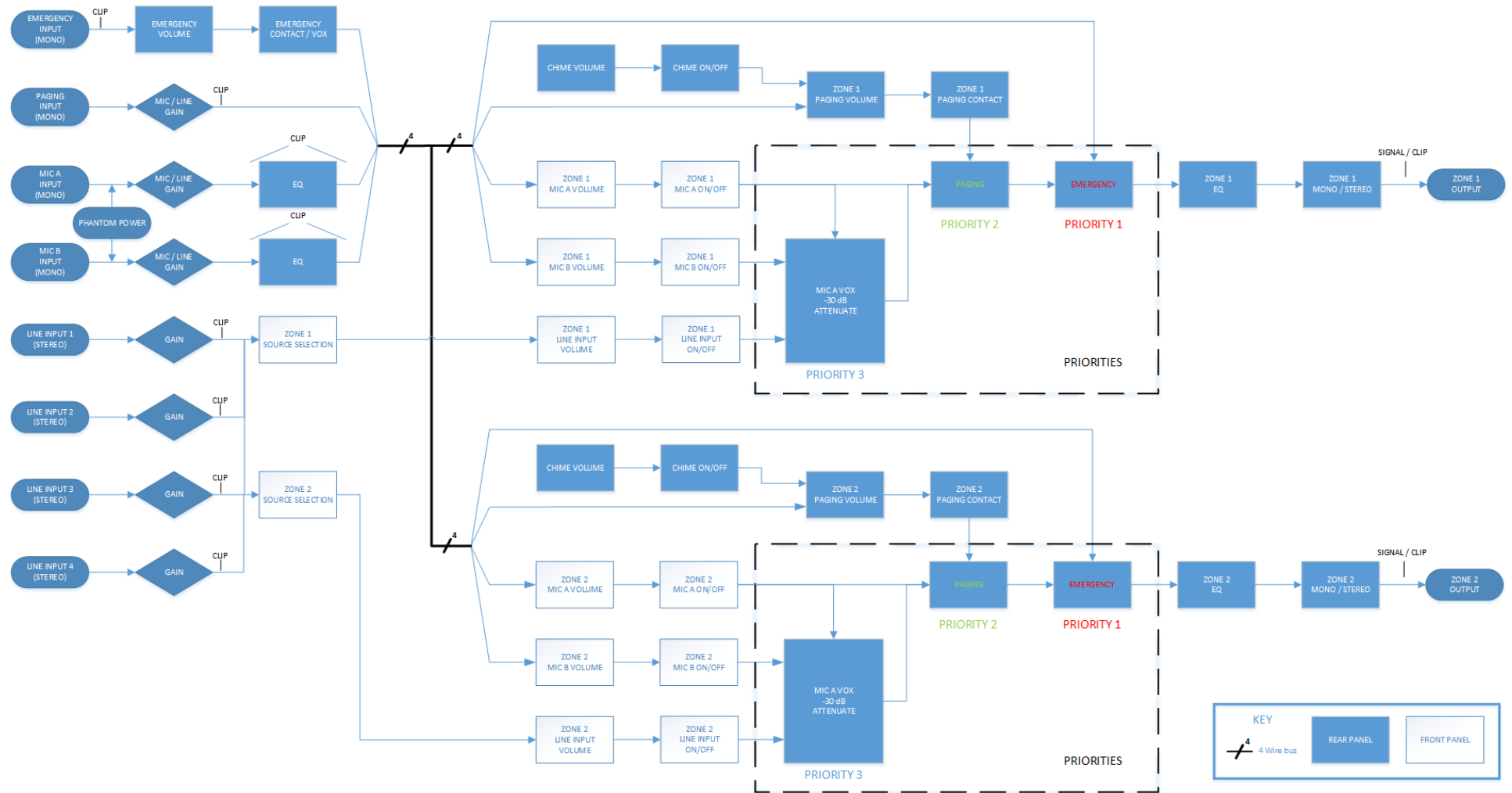

Figure 17. Signal Flow Diagram

Firmware Upgrade

Firmware may be updated on the PREZONE2 by downloading the upgrade package located on www.biamp.com/downloads. A PC running Windows™ is required (32 and 64 bit supported).

The PC must be connected to the PREZONE2 via the RS232 port on the back of the device. The user will need an RS232 connector (if the PC has an RS232 port) or a USB to RS232 connector. See Figure 18 for a connection diagram.

1. Click [this link](#) to automatically download the firmware upgrade tool.
2. Unzip the contents. The file contains the .exe firmware upgrade tool and two PDF files (troubleshooting guide and release notes).
3. Double click the .exe file and install it on the PC that will be connected to the PREZONE2. A shortcut will be installed on the desktop by default.
4. Connect the PC to the PREZONE2 RS232 port via an appropriate connector as shown in Figure 18.
5. Power on the PREZONE2.
6. Double-click the Firmware upgrade application on the PC.
7. The user will be presented with the following screen:

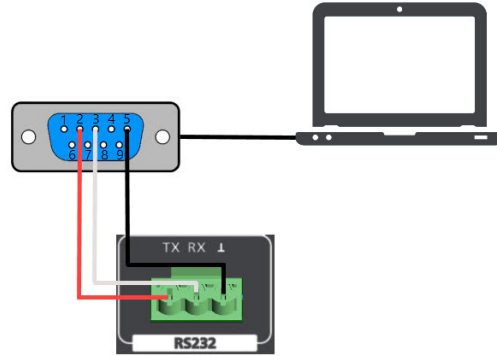

Figure 18. RS232 Wiring

8. Choose the serial port that the USB to RS232 is connected to.
9. Click 'Connect' and follow the on-screen instructions.
10. Once the upgrade is complete, power down the PREZONE2 and disconnect the USB to RS232 connector.

Firmware Upgrade Troubleshooting

Common problems and solutions are listed in the table below. For a comprehensive list of troubleshooting tips and other content to assist with a successful firmware upgrade, see the README PDF in the firmware upgrade package.

Problem	Try This
No serial port listed in the tool drop-down.	<ul style="list-style-type: none"> • Check the physical connections. • Make sure drivers are current for the USB to RS232 connector (if used).
PREZONE2 is powered-on but appears non-functional.	<ul style="list-style-type: none"> • Power cycle the unit (wait 10 seconds between powering on after turning it off.) • If the device still does not boot properly after a power cycle, try updating the firmware again.
Connections appear normal, but upgrade fails.	<ul style="list-style-type: none"> • Use an RS232 terminal session to verify proper connection (see README PDF for detailed troubleshooting steps.)
PREZONE2 is verified to be connected properly and the upgrade fails.	<ul style="list-style-type: none"> • Power cycle the unit (wait 10 seconds between powering on after turning it off.) • Disconnect/reconnect the USB/RS232 connection. • Try a different USB port on the PC. • Try a new USB/RS232 connector (quality and stability of the connection may be a factor.)

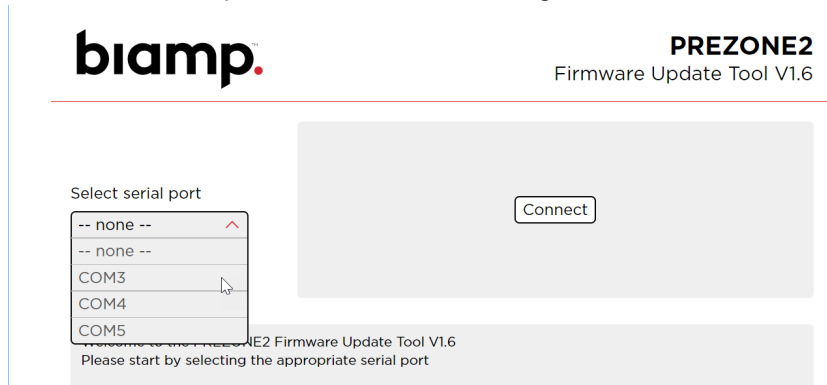

CONTACT US

Email

support@biamp.com

Web

support.biamp.com



Note: Every effort has been made to ensure that the information contained in this manual was complete and accurate at the time of printing. However, due to ongoing technical advances, changes or modifications may have occurred that are not covered in this manual. The latest version is available at www.biamp.com.



A: 9300 S.W. Gemini Drive Beaverton, OR 97008 USA

W: www.biamp.com

JUL 2020