

# **PTZ Optics 12x 3G-SDI (GEN 2)**



## **User Manual**

**Model Nos: PT12X-SDI-GY-G2 & PT12X-SDI-WH-G2**

**V1.7**

**(English)**

Please check [PTZOPTICS.com](http://PTZOPTICS.com) for the most up to date version of this document

Rev 1.7 8/20

## Preface

Thank you for using the HD Professional Video Conferencing Camera. This manual introduces the function, installation and operation of the HD camera. Prior to installation and usage, please read the manual thoroughly.

## Precautions

This product can only be used in the specified conditions in order to avoid any damage to the camera:

- Don't subject the camera to rain or moisture.
- Don't remove the cover. Removal of the cover may result in an electric shock. In addition to voiding the warranty. In case of abnormal operation, contact the manufacturer.
- Never operate outside of the specified operating temperature range, humidity, or with any other power supply than the one originally provided with the camera.
- Please use a soft dry cloth to clean the camera. If the camera is very dirty, clean it with diluted neutral detergent; do not use any type of solvents, which may damage the surface.

## Note

This is an FCC Class A Digital device. As such, unintentional electromagnetic radiation may affect the image quality of TV in a home environment.

## Warranty

PTZOptics includes a limited parts & labor warranty for all PTZOptics manufactured cameras. Warranty lengths are shown below. The warranty is valid only if PTZOptics receives proper notice of such defects during the warranty period. PTZOptics, at its option, will repair or replace products that prove to be defective. PTZOptics manufactures its hardware products from parts and components that are new or equivalent to new in accordance with industry standard practices.

	Serial Number	Warranty
(White)	AE1231999 and before	3 year warranty
	AF0101001 and after	5 year warranty
(Gray)	BE1231999 and before	3 year warranty
	BF0101001 and after	5 year warranty





Share Your Vision

## Table of Contents

<a href="#">Supplied Accessories</a> .....	1
<a href="#">Notes</a> .....	1
<a href="#">Quick Start</a> .....	2
<a href="#">Features</a> .....	4
<a href="#">Product Specifications</a> .....	5
<a href="#">Back of the Camera</a> .....	7
<a href="#">IR Remote Controller</a> .....	8
<a href="#">Using the IR Remote Controller</a> .....	10
<a href="#">Dimensional Drawings</a> .....	13
<a href="#">RS-232 Interface</a> .....	14
<a href="#">VISCA Command List</a> .....	16
<a href="#">Menu Settings</a> .....	30
<a href="#">Exposure</a> .....	30
<a href="#">Color</a> .....	31
<a href="#">Image</a> .....	31
<a href="#">P/T/Z</a> .....	31
<a href="#">Noise Reduction</a> .....	32
<a href="#">Setup</a> .....	32
<a href="#">Communication Setup</a> .....	33
<a href="#">Restore Default</a> .....	33
<a href="#">Network Connection</a> .....	34
<a href="#">Setting up a Network Video Stream</a> .....	35
<a href="#">Additional Network Info</a> .....	37
<a href="#">Camera Web Interface</a> .....	38
<a href="#">Live</a> .....	38
<a href="#">Directional Arrows</a> .....	38
<a href="#">Video</a> .....	39
<a href="#">Image</a> .....	40
<a href="#">Audio</a> .....	40
<a href="#">System</a> .....	40
<a href="#">Network</a> .....	41
<a href="#">Information</a> .....	43
<a href="#">Language</a> .....	43
<a href="#">Network Camera Control Protocol</a> .....	43
<a href="#">Photobooth Functionality</a> .....	46
<a href="#">Maintenance and Troubleshooting</a> .....	48

## Supplied Accessories

When you unpack your camera, check that all the supplied accessories are included:

- Camera ..... 1
- AC Power Adaptor..... 1
- Power Cord..... 1
- RS232 Cable..... 1
- IR Remote Controller ..... 1
- Quick Start Guide ..... 1
- AAA Batteries..... 2

## Notes

### ● Electrical Safety

Installation and operation must be in accordance with national and local electric safety standards. Do not use any power supply other than the one originally supplied with this camera.

### ● Polarity of power supply

The power supply output for this product is 12VDC with a maximum current supply of 2A. Polarity of the power supply plug is critical and is as follows.



### ● Handling

- Avoid any stress, vibration, or moisture during transportation, storage, installation and operation.
  - Do not lift or move the camera by grasping the camera head. Do not turn the camera head by hand. Doing so may result in mechanical damage.
  - Do not expose camera to any corrosive solid, liquid, or gas to avoid damage to the cover which is made of a plastic material.
  - Ensure that there are no obstacles in the tilt or pan ranges of the camera lens.
  - Never power camera on before installation is complete.
- **Do not dismantle the camera** - The manufacturer is not responsible for any unauthorized modification or dismantling.

## Quick Start

**Step 1.** Please check that all connections are correct before powering on the camera.

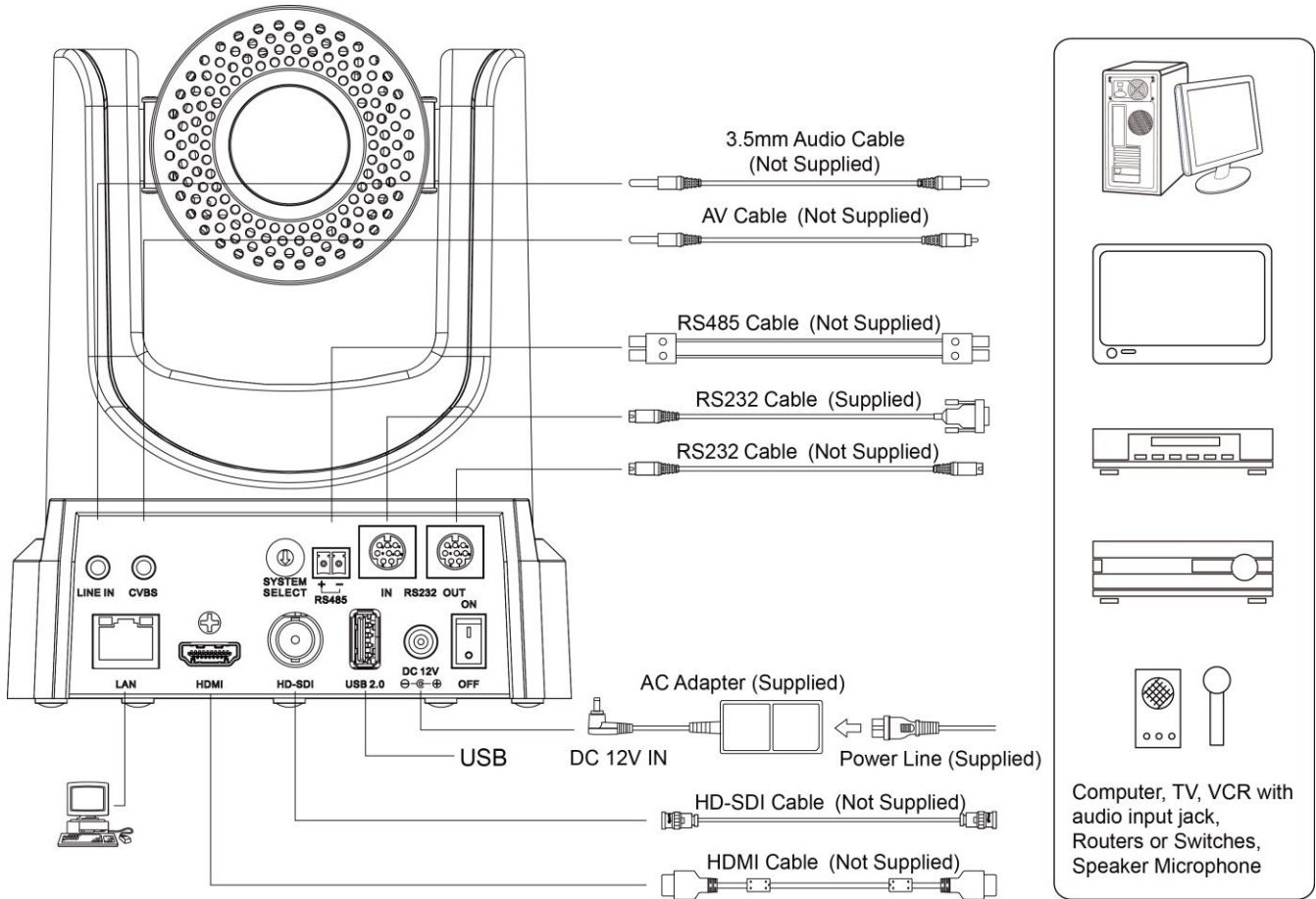

**Step 2.** Set the system select switch for your desired video output resolution and frame rate.

For many applications, setting 0 (1080p-60) will provide the best overall performance.

For highest possible resolution, use setting 0 (1080p-60) or 6 (1080p-30), however your actual realized frame rate may be limited to a lower value than 60 fps by your software, hardware, and/or network connection.

**NOTE:** After changing this dial, you need to restart the camera to see the effect. Turn the camera off then on.

VIDEO SYSTEM			
0	1080p60	8	720p30
1	1080p50	9	720p25
2	1080i60	A	1080p59.94
3	1080i50	B	1080i59.94
4	720p60	C	1080p29.97
5	720p50	D	576i
6	1080p30	E	480i
7	1080p25	F	720p59.94

**CAUTION:** After changing the system (rotary) switch, you need to restart the camera to take effect.

**CAUTION:** A, B, C, & F Broadcast frame rate options are considered BETA features and may not be supported by all platforms

**Step 3.** Press the Switch ON button on the rear of the camera, the power LED will illuminate.

**Step 4.** The Pan-Tilt mechanism will rotate the lens to the maximum position of top right after the camera starts, then it will return to the “center”. The process of initialization is now complete.

(Note: If the position preset 0 has been stored, the position preset 0 will be called up after initialization in lieu of “center”)

**Step 5. (Optional)** If you want to restore the factory default settings, press [MENU] button to display the OSD menu. Select the item [MENU] -> [RESTORE DEFAULT] -> [Restore]. Set the value [Yes], press [HOME] button to restore the factory default settings. Or when using the IR remote, press [\*] + [#] + [6] in succession to restore to factory default settings.

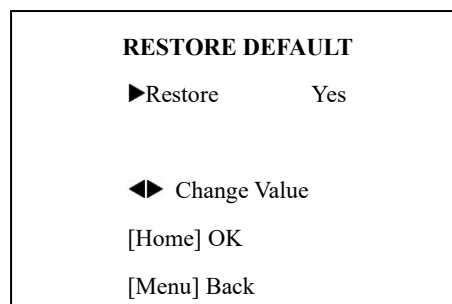

## Features

- Image Sensor
  - Panasonic 1/2.7", 2.07 million effective pixels, HD CMOS sensor
  - Olympus high quality telephoto lens supporting 12X optical zoom and optional 16X digital zoom
  - Full HD 1920x1080p resolution up to 60 frames per second
  - 2D & 3D noise reduction with our latest “low noise CMOS sensor”
  - 0.05 Lux @ F1.8 AGC On
  - Wide angle 72.5° horizontal field of view
  - Dynamic Range Control (DRC) for higher image quality and detail across simultaneously well lit and shadowed scenes.
  - Image Freeze to temporarily pause the video while calling presets (so viewers won't see camera movement)
  - High SNR (signal to noise ratio) of the CMOS sensor ( $\geq 55\text{dB}$ ), combined with 2D & 3D noise reduction algorithms, effectively reduces noise, even under low illumination conditions.
- Video Outputs
  - Simultaneous IP network streaming, 3G-SDI, and HDMI video outputs.
  - 3G-SDI High Definition video output up to 60 frames per second
  - HDMI 1.3 High Definition video output up to 60 frames per second
  - RTSP, RTMP, & RTMPS streaming using H.264, H.265, & MJPEG
  - Line level audio embedding over IP network stream & HDMI. Uses AAC audio encoding for better sound quality and lower bandwidth usage.
  - Support for ultra-high FPS mode 1280x720p @ 120 frames per second over IP network stream.
  - Supports non-simultaneous CVBS (composite video) output via 3.5mm connector (480i or 576i)
- Control and Settings
  - PTZOptics VISCA over IP
  - IR Remote Control
  - Web-based IP remote control interface
  - RS232 & RS485 VISCA, Pelco-D, & Pelco-P control
- Installation
  - Standard 1/4-20 female thread for camera mounting
  - Power over Ethernet – Supports 802.3af
  - 12VDC 2A Power Supply provided for non-PoE infrastructure
- Warranty
  - 5-year warranty

## Product Specifications

<b>Model</b>	PT12X-SDI-GY-G2 and PT12X-SDI-WH-G2
<b>Type</b>	PTZOptics 3G-SDI HD 1080p Color Video Camera (GEN 2)
<b>Features</b>	
Video System	1080p-60/50/30/25/59.94*/29.97* 1080i-60/50/59.94* 720p-60/50/59.94* CVBS: 576i, 480i *Broadcast frame rates are considered BETA features and may not be supported by all platforms
Sensor	1/2.7", CMOS, Effective Pixel: 2.07M
Scanning Mode	Progressive
Lens	12x, f3.5mm ~ 42.3mm, F1.8 ~ F2.8
Digital Zoom	16x
Minimal Illumination	0.05 Lux (@F1.8, AGC ON)
Shutter	1/30s ~ 1/10000s
White Balance	Auto, Indoor, Outdoor, One Push, Manual, VAR
Backlight Compensation	Support
Digital Noise Reduction	2D & 3D Digital Noise Reduction
Video S/N	≥55dB
Horizontal Angle of View	6.9° ~ 72.5°
Vertical Angle of View	3.9° ~ 44.8°
Horizontal Rotation Range	±170°
Vertical Rotation Range	-30° ~ +90°
Pan Speed Range	1.7° ~ 100°/s
Tilt Speed Range	1.7° ~ 69.9°/s
Image Flip	Support
Image Mirror	Support
Image Freeze	Support
PoE	Support (802.3af)
Face Detection	Not Supported
Local Storage	Not Supported
Number of Preset	255
Preset Accuracy	0.1°
<b>Input/Output Interface</b>	
HD Output	1 x HDMI: Version 1.3
	1 x 3G-SDI: BNC type, 800mVp-p, 75Ω, Along to SMPTE 424M standard
	1 x RJ45 IP Network streaming 10/100/1000 Ethernet port
SD Output	1 x CVBS: 3.5mm jack, 1Vp-p, 75Ω
Network Interface	1 x RJ45: 10/100/1000M Adaptive Ethernet ports





Share Your Vision

Audio Input	1-ch 3.5mm audio interface, Line In (IP Network stream only)(Unbalanced stereo)
USB	1 x USB2.0: type A jack
Communication Interface	1 x RS-232 IN: 8pin Min DIN, Max Distance: 30m, Protocol: VISCA/Pelco-D/Pelco-P
	1 x RS-232 OUT: 8pin Min DIN, Max Distance: 30m, Protocol: VISCA network use only
	1 x RS-485: 2pin Phoenix port, Max Distance: 1200m, Protocol: VISCA/Pelco-D/Pelco-P
Power Jack	JEITA type (DC IN 12V)
<b>IP Video Features</b>	
Video Compression	H.264 / H.265 / M-JPEG
Video Stream	Two (2) IP video output streams available
First Stream Resolutions	1920x1080, 1280x720, 1024x576, 960x540, 640x480, 640x360
Second Stream Resolutions	1280x720, 1024x576, 720x480, 720x408, 640x360, 480x270, 320x240, 320x180
Video Bit Rate	32Kbps ~ 102400Kbps
Bit Rate Type	Variable Rate, Fixed Rate
Frame Rate	50Hz: 1 FPS ~ 50 FPS, 60Hz: 1 FPS ~ 60 FPS
Audio Compression	AAC
Audio Bit Rate	96Kbps, 128Kbps, 256Kbps
Supported Protocols	TCP/IP, HTTP, RTSP, RTMP, DHCP, Multicast, etc.
<b>Generic Specification</b>	
Input Voltage	JEITA type (DC IN 12V) or RJ45 via PoE 802.3af
Current Consumption	1.0A (Max)
Operating Temperature	14°F ~ 104°F [-10°C ~ 40°C]
Storage Temperature	-40°F ~ 140°F [-40°C ~ 60°C]
Humidity Range	10% - 80%
Power Consumption	12W (Max)
MTBF	>30000h
Size in. (W x D x H)	5.6" W x 6.7" D x 6.5" H (7.88" H max height w/ tilt)
Size mm. (W x D x H)	142mm W x 169mm D 164mm H (189mm H max height w/ tilt)
Camera Weight	3.20 lbs. [1.45 kg]
Box Weight	5.4 lbs. [2.45 kg]

## Back of the Camera

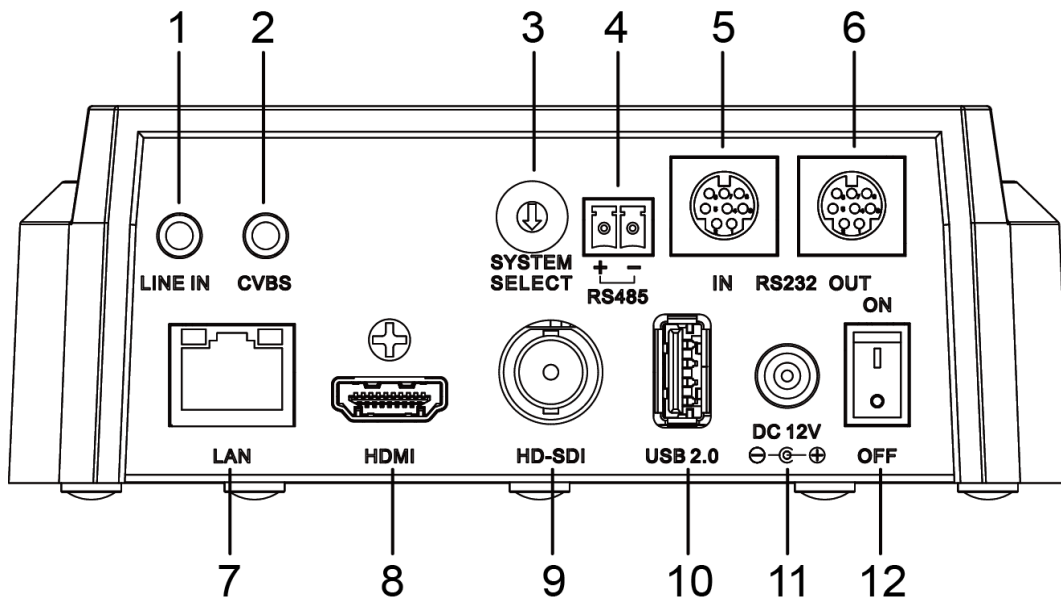

- |  |   |
|--|---|
| 1. Audio LINE IN Interface (IP Stream & HDMI only) | 7. Network (IP streaming and control)             |
| 2. CVBS (composite video SD) Interface             | 8. HDMI 1.3 (Digital Video Output)                |
| 3. System select dial (resolution)                 | 9. 3G-SDI (Serial Digital Video Output)           |
| 4. RS485 jack                                      | 10. USB 2.0 (*no video out* Future - USB Storage) |
| 5. RS232 IN jack                                   | 11. DC 12V power jack                             |
| 6. RS232 OUT jack (pass through for daisy chain)   | 12. Power switch                                  |

# IR Remote Controller

## 1. Standby Button

Press this button to enter standby mode. Press it again to enter normal mode.

NOTE: Power consumption in standby mode is approximately half of the normal mode.

## 2. Position Buttons

To set preset or call preset.

## 3. \* Button

For multiple function.

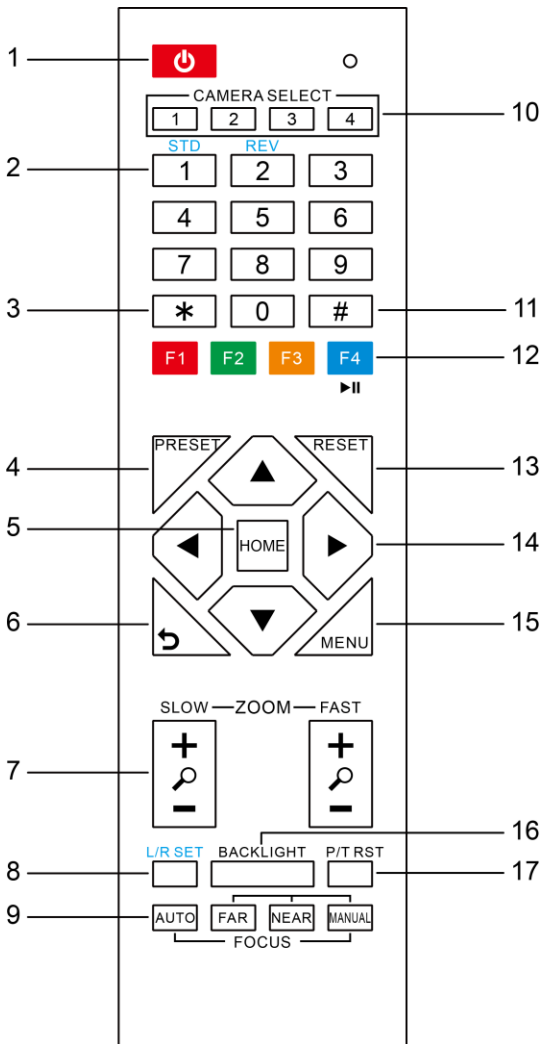

## 4&13. Set/Clear Preset Buttons

Set preset: Store a preset position

[PRESET] + Numeric button (0-9): Setting a corresponding numeric key preset position

NOTE: Preset 0 - 9 via remote control and the rest from web, keyboard and the serial port.

Clear preset: Erase a preset position [RESET] + Numeric button (0-9), or: [\*] + [#] + [RESET]: Erase all presets

## 5&14. Pan/Tilt Control Buttons

Press the arrow buttons to perform panning and tilting. Press the [HOME] button to face the camera back to front.

## 6. Return Button

Press the button to back previous menu.

## 7. Zoom Buttons

Zoom+: Zoom In (Slow and fast speed)

Zoom-: Zoom Out (Slow and fast speed)

## 8. L/R Set Button

Set the left & right direction of the remote control.

[L/R Set] + [1]: Normal direction.

[L/R Set] + [2]: Left and right direction will be reversed.

## 9. Focus Buttons

Used for focus adjustment.

Press [AUTO] to adjust the focus on the center of the object automatically. To adjust the focus manually, press the [MANUAL] button, and adjust it with [Far] (focus on far object) and [Near] (focus on near object).

## 10. Camera Address Select Buttons

Press the button corresponding to the camera which you want to operate with the remote controller.

## 11. # Button

For multiple function.

## 12. Multiple Function Buttons

Function 1. Set camera IR address

Press 3 keys contiguously can set camera IR address as follow:

[\*] + [#] + [F1]: Address 1

[\*] + [#] + [F2]: Address 2

[\*] + [#] + [F3]: Address 3

[\*] + [#] + [F4]: Address 4

Function 2. Image freezing function

Press [F4] to start the freeze function. The word "Freeze" displays on the upper left corner. After five seconds, the display disappears automatically (though the freeze feature continues). To cancel the freeze, press the [F4] key the word "Unfreeze" displays on the upper left corner. After five seconds, the display disappears automatically.

## 15. Menu Setting

Menu button: Press this button to enter or exit the OSD menu.

## 16. Backlight Button

Backlight button: Press this button to enable the backlight compensation. Press it again to disable the backlight compensation.

NOTE: Effective only in auto exposure mode.

NOTE: If there is a light behind the subject, the subject will appear dark. In this case, press the backlight ON / OFF button. To cancel this function, press the backlight ON / OFF button.

## 17. P/T RST Button

Press the button to self-calibrate pan and tilt once again.

### Shortcuts for some 'Set' Functions

[\*] + [#] + [1]: Display OSD menu in English

[\*] + [#] + [3]: Display OSD menu in Chinese

[\*] + [#] + [4]: Show IP address

[\*] + [#] + [6]: Quickly restore the default settings

[\*] + [#] + [8]: Show the camera version

[\*] + [#] + [9]: Quickly set mount mode (flip / normal)

[\*] + [#] + [MANUAL]: Resets IP information

[#] + [\*] + [4]: Enable Dynamic IP addressing

[#] + [\*] + [#] + [1]: Sets IP address to 192.168.100.81

[#] + [\*] + [#] + [2]: Sets IP address to 192.168.100.82

[#] + [\*] + [#] + [3]: Sets IP address to 192.168.100.83

[#] + [\*] + [#] + [4]: Sets IP address to 192.168.100.84

[#] + [\*] + [#] + [5]: Sets IP address to 192.168.100.85

[#] + [\*] + [#] + [6]: Sets IP address to 192.168.100.86

[#] + [\*] + [#] + [7]: Sets IP address to 192.168.100.87

[#] + [\*] + [#] + [8]: Sets IP address to 192.168.100.88

[#] + [\*] + [#] + [9]: Sets IP address to 192.168.100.89

[#] + [\*] + [#] + [0]: Sets IP address to 192.168.100.80

## Using the IR Remote Controller

When the camera is operational, you can use the remote controller to perform panning, tilting, zooming and focusing, as well as store and call back preset positions.

Button Instructions:

1. In these instructions, ‘press the button’ means to press and release. A special note will be given if holding a button down for more than one second is required.

2. When a button-combination is required, do it in sequence (not simultaneously). For example, ‘[\*] + [#] + [F1]’ means press [\*] first and then press [#] and then press [F1].

### 1. Pan/Tilt Control

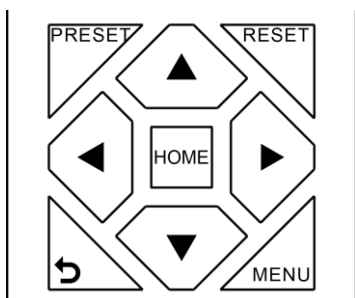

- Tilt up: Press [▲]
- Tilt down: Press [▼]
- Pan left: Press [◀]
- Pan right: Press [▶]
- Face the camera back to front: Press [HOME]

**Press and hold** the up/down/left/right buttons, to keep panning or tilting from slow to fast, (until the camera reaches the mechanical limit). The camera stops as soon as the button is released.

### 2. Zoom Control

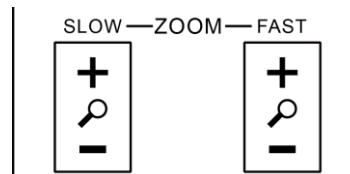

Zoom Out: press [+] button under FAST or SLOW

Zoom In: press [-] button under FAST or SLOW

**Press and hold** the button, to keep zooming in or out (until the lens reaches the mechanical limit). The lens stops as soon as the button is released.

### 3. Focus Control

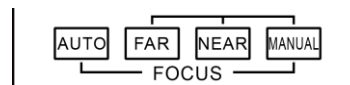

**AUTO:** Change focus mode to AF, which allows the camera to adjust the focus automatically on the center of the image.

**MANUAL:** Change focus mode to MF, which allows the user to adjust the focus manually (see FOCUS FAR & FOCUS NEAR).

**FOCUS FAR:** Press [FAR] button (NOTE: Effective only in MANUAL focus mode)

**FOCUS NEAR:** Press [NEAR] button (NOTE: Effective only in MANUAL focus mode)

**Press and hold** the FOCUS [FAR] or FOCUS [NEAR] button, allows for continuous adjustment, stopping as soon as the button is released.

#### 4. BACKLIGHT. L/R SET and P/T RST Controls

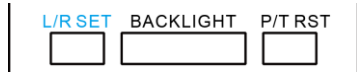

Reverse Pan controls direction: Press and hold [L/R SET] button while pressing [1] aka [STD] button for normal pan controls. Press and hold [L/R SET] button while pressing [2] aka [REV] button for reversed pan controls.

Backlight Compensation Control: Press [BACKLIGHT] button to enable backlight compensation. Press it again to disable backlight compensation. (Note: Backlight is only effective in full auto exposure mode)

Pan Tilt Control Self Calibration: Press [P/T RST] button to recalibrate the Pan and Tilt limits.

#### 5. Standby Control



Press [ ] button to put camera in ‘standby’ mode. In standby mode the camera will provide no image, respond to no commands and use less than half its normal power. Press [ ] button again to put camera in normal mode.

#### 6. Presets - Setting and Clearing

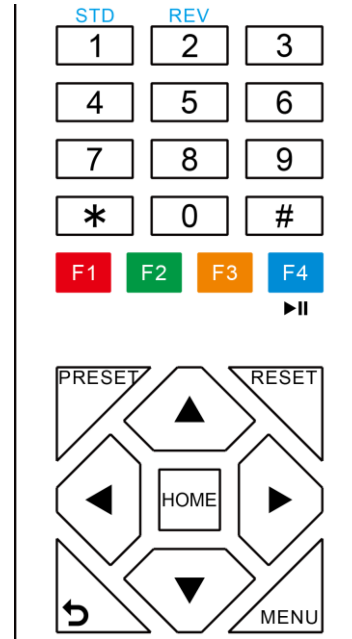

1. To store a preset position: The user should manually setup the desired shot using the Pan Tilt and Zoom controls. Press the [PRESET] button first and then press the numeric button [0-9] to which you want to assign the shot. Ten total preset positions (0-9) are available from the IR remote control (255 available via RS232/RS485/IP Interfaces).

2. To erase the memory content of a preset position: The user should press the [RESET] button first and then press the numeric button 0-9 associated with that preset.

**Note:**

Pressing [\*] + [#] + [RESET] in sequence will erase all presets in the memory.

### 7. Recalling Presets

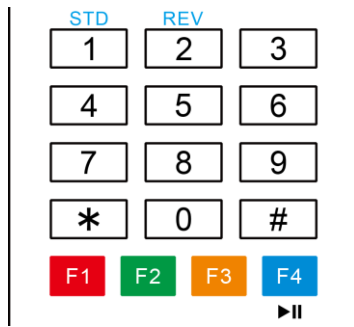

Pressing any of the numeric buttons [0-9] directly will recall a stored preset position and settings.

**Note:**

No action will be executed if a specific numeric preset position has not yet been saved.

### 8. Camera Selection

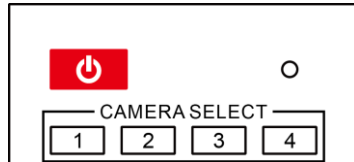

Press the [1-4] button corresponding to the camera with the IR address that you want to operate. This allows for up to 4 cameras to be operated via the same IR remote in the same room.

### 9. Camera IR Address Set



Press 3 buttons in the sequence shown below to set/change the camera’s IR address. This allows up to 4 cameras to be controlled from the same IR remote control. Be sure that only one camera is picking up the IR signal when you perform this function. If multiple cameras receive the command, they will all change to the new address.

Address 1: [\*] + [#] + [F1]

Address 2: [\*] + [#] + [F2]

Address 3: [\*] + [#] + [F3]

Address 4: [\*] + [#] + [F4]

### 10. Image Freeze



Press the [▶||] button to freeze or unfreeze the video image. This can be useful while recalling presets to hide camera motion from your viewers.

## Dimensional Drawings (mm)

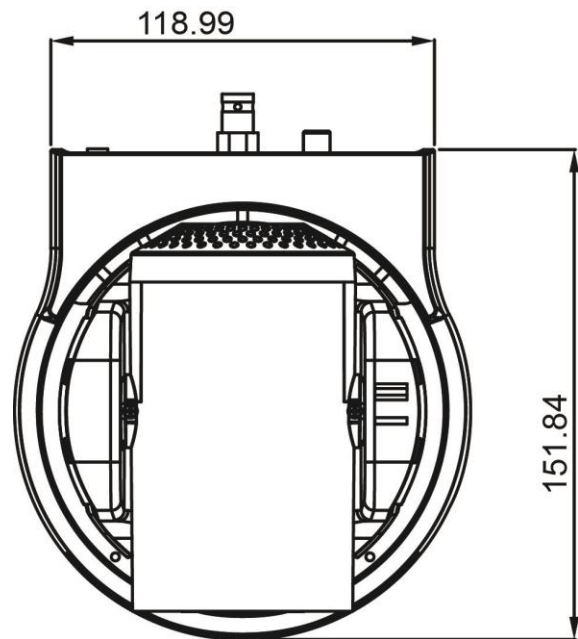
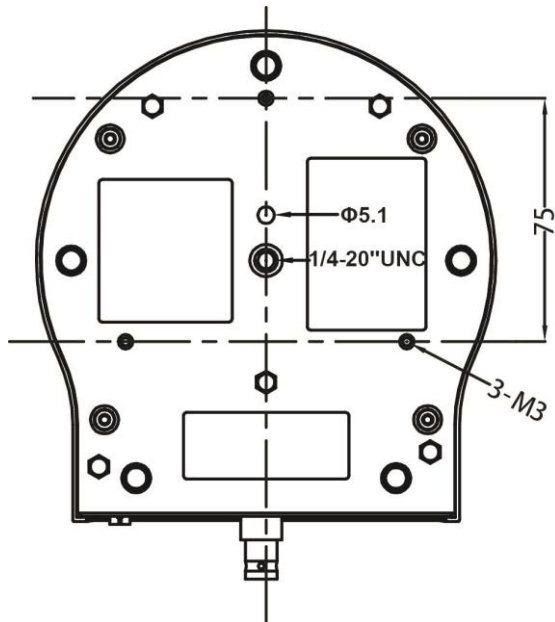
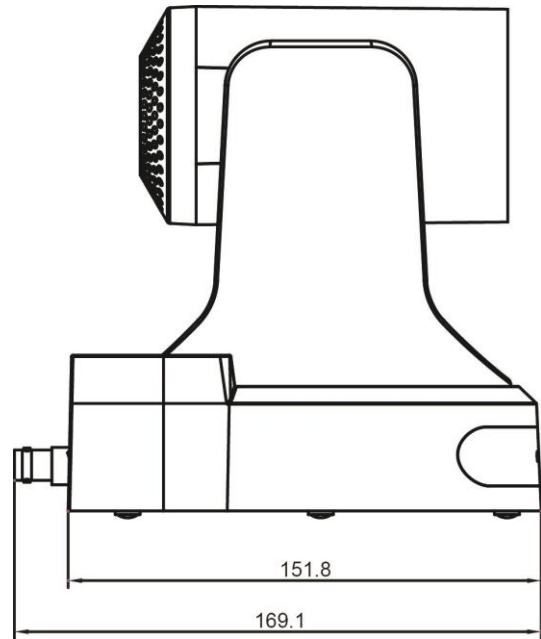
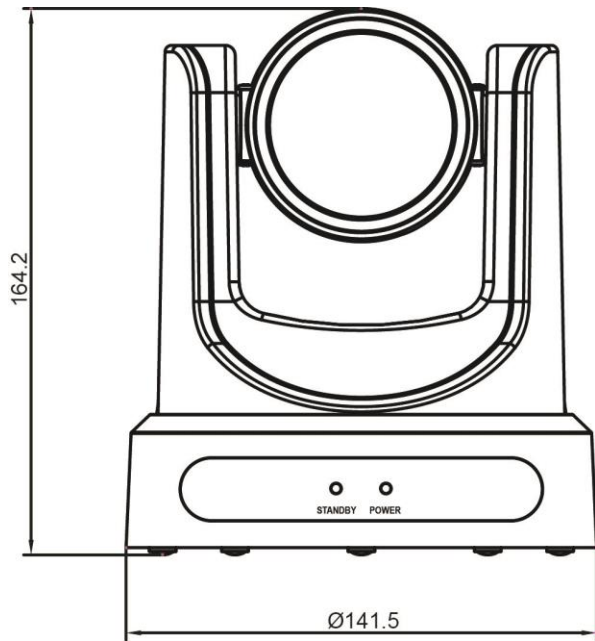



## RS-232 Interface

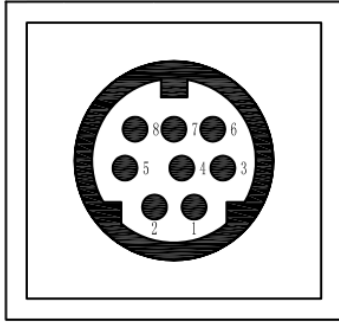

No.	Function
1	DTR
2	DSR
3	TXD
4	GND
5	RXD
6	GND
7	IR OUT
8	NC

### Camera      PC/Controller DB-9

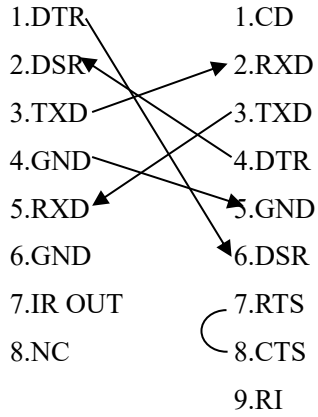

### For Control Daisy Chain

#### 1<sup>st</sup> Camera      2<sup>nd</sup> Camera Mini DIN

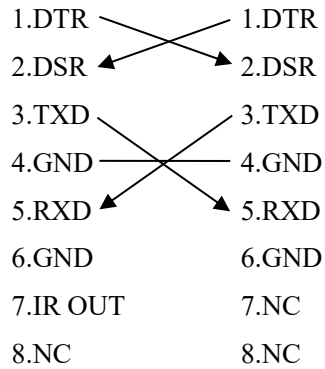

## Serial Communication Control

In default working mode, the camera is able to connect to a VISCA controller with an RS232C serial interface.

➤ **RS232 Communication Control**

The camera can be controlled via RS232. The parameters of RS232C are as follows:

Baud rate: 2400, 4800 or 9600 bps.

Start bit: 1 bit.

Data bit: 8 bits.

Stop bit: 1 bit.

Parity bit: none.

➤ **RS485 Communication Control**

The camera can be controlled via RS485, Half-duplex mode, with support for VISCA, Pelco-D or Pelco-P protocol.

The parameters of RS485 are as follows:

Baud rate: 2400, 4800 or 9600 bps.

Start bit: 1 bit.

Data bit: 8 bits.

Stop bit: 1 bit.

Parity bit: none.

# VISCA Command List

## Part 1: Camera-Issued Messages

ACK/Completion Message			
Command	Function	Command Packet	Comments
ACK/Completion Messages	ACK	z0 4y FF (y: Socket No.)	Returned when the command is accepted.
	Completion	z0 5y FF (y: Socket No.)	Returned when the command has been executed.

Error Messages			
Command	Function	Command Packet	Comments
Error Messages	Syntax Error	z0 60 02 FF	Returned when the command format is different or when a command with illegal command parameters is accepted.
	Command Buffer Full	z0 60 03 FF	Indicates that two sockets are already being used (executing two commands) and the command could not be accepted when received.
	Command Canceled	z0 6y 04 FF (y: Socket No.)	Returned when a command which is being executed in a socket specified by the cancel command is canceled. The completion message for the command is not returned.
	No Socket	z0 6y 05 FF (y: Socket No.)	Returned when no command is executed in a socket specified by the cancel command, or when an invalid socket number is specified.
	Command Not Executable	z0 6y 41 FF (y: Execution command Socket No. Inquiry command: 0)	Returned when a command cannot be executed due to current conditions. For example, when commands controlling the focus manually are received during auto focus.

z = Camera Address + 8

**Part 2: VISCA Command List**

Command	Function	Command Packet	Comments
CAM_Power	On	8x 01 04 00 02 FF	Power ON/OFF
	Off	8x 01 04 00 03 FF	
CAM_Zoom	Stop	8x 01 04 07 00 FF	
	Tele (Standard)	8x 01 04 07 02 FF	
	Wide (Standard)	8x 01 04 07 03 FF	
	Tele (Variable)	8x 01 04 07 2p FF	p = 0(low) - 7(high)
	Wide (Variable)	8x 01 04 07 3p FF	
	Direct	8x 01 04 47 0p 0q 0r 0s FF	pqrs: Zoom Position
CAM_Focus	Stop	8x 01 04 08 00 FF	
	Far (Standard)	8x 01 04 08 02 FF	
	Near (Standard)	8x 01 04 08 03 FF	
	Far (Variable)	8x 01 04 08 2p FF	p = 0(low) - 7(high)
	Near (Variable)	8x 01 04 08 3p FF	
	Direct	8x 01 04 48 0p 0q 0r 0s FF	pqrs: Focus Position
	Auto Focus	8x 01 04 38 02 FF	AF On/Off
	Manual Focus	8x 01 04 38 03 FF	
	Auto/Manual	8x 01 04 38 10 FF	
	Focus Lock	8x 0a 04 68 02 FF	Prevents any other operation or command from adjusting the current focus state
Focus Unlock	8x 0a 04 68 03 FF		
CAM_WB	Auto	8x 01 04 35 00 FF	Normal Auto
	Indoor mode	8x 01 04 35 01 FF	Indoor mode
	Outdoor mode	8x 01 04 35 02 FF	Outdoor mode
	OnePush mode	8x 01 04 35 03 FF	One Push WB mode
	Manual	8x 01 04 35 05 FF	Manual Control mode
	Color Temperature	8x 01 04 35 20 FF	Color Temperature mode
	OnePush trigger	8x 01 04 10 05 FF	One Push WB Trigger
CAM_RGain	Reset	8x 01 04 03 00 FF	Manual Control of R Gain
	Up	8x 01 04 03 02 FF	
	Down	8x 01 04 03 03 FF	
	Direct	8x 01 04 43 00 00 0p 0q FF	pq: R Gain
CAM_Bgain	Reset	8x 01 04 04 00 FF	Manual Control of B Gain
	Up	8x 01 04 04 02 FF	
	Down	8x 01 04 04 03 FF	
	Direct	8x 01 04 44 00 00 0p 0q FF	pq: B Gain
CAM_ColorTemp	Reset	8x 01 04 20 00 FF	Default ColorTemperature setting
	Up	8x 01 04 20 02 FF	
	Down	8x 01 04 20 03 FF	

	Direct	8x 01 04 20 0p 0q FF	pq: Color Temperature position 0x00: 2500K ~ 0x37: 8000K
CAM_AE	Full Auto	8x 01 04 39 00 FF	Automatic Exposure mode
	Manual	8x 01 04 39 03 FF	Manual Control mode
	Shutter priority	8x 01 04 39 0A FF	Shutter Priority Automatic Exposure mode
	Iris priority	8x 01 04 39 0B FF	Iris Priority Automatic Exposure mode
	Bright	8x 01 04 39 0D FF	Bright Mode(Manual control)
CAM_Iris	Reset	8x 01 04 0B 00 FF	Iris Setting
	Up	8x 01 04 0B 02 FF	
	Down	8x 01 04 0B 03 FF	
	Direct	8x 01 04 4B 00 00 0p 0q FF	pq: Iris Position
CAM_Shutter	Reset	8x 01 04 0A 00 FF	Default Shutter setting
	Up	8x 01 04 0A 02 FF	
	Down	8x 01 04 0A 03 FF	
	Direct	8x 01 04 4A 00 00 0p 0q FF	pq: Shutter Position
CAM_Bright	Reset	8x 01 04 0D 00 FF	Bright Setting
	Up	8x 01 04 0D 02 FF	
	Down	8x 01 04 0D 03 FF	
	Direct	8x 01 04 0D 00 00 0p 0q FF	pq: Bright Position
CAM_ExpComp	On	8x 01 04 3E 02 FF	Exposure Compensation On/Off
	Off	8x 01 04 3E 03 FF	
	Reset	8x 01 04 0E 00 FF	Exposure Compensation Amount Setting
	Up	8x 01 04 0E 02 FF	
	Down	8x 01 04 0E 03 FF	
	Direct	8x 01 04 4E 00 00 0p 0q FF	pq: ExpComp Position
CAM_BackLight	On	8x 01 04 33 02 FF	Back Light Compensation On/Off
	Off	8x 01 04 33 03 FF	
CAM_Flicker	-	8x 01 04 23 0p FF	p: Flicker Settings (0: Off, 1: 50Hz, 2: 60Hz)
CAM_PictureEffect	Off	8x 01 04 63 00 FF	Picture Effect Setting
	B&W	8x 01 04 63 04 FF	
CAM_Memory	Reset	8x 01 04 3F 00 pp FF	pp: Memory Number (=0 to 127)
	Set	8x 01 04 3F 01 pp FF	
	Recall	8x 01 04 3F 02 pp FF	
Preset Recall Speed	Preset Speed	8x 01 06 01 p FF	p: speed grade, the values are (0x01~0x18)
CAM_LR_Reverse	On	8x 01 04 61 02 FF	Image Flip Horizontal On/Off
	Off	8x 01 04 61 03 FF	
CAM_PictureFlip	On	8x 01 04 66 02 FF	Image Flip Vertical On/Off
	Off	8x 01 04 66 03 FF	
CAM_ColorGain	Direct	8x 01 04 49 00 00 00 0p FF	p: Color Gain setting 0h (60%) to Eh (200%)
Pan_tiltDrive	Up	8x 01 06 01 VV WW 03 01 FF	VV: Pan speed 0x01 (low speed) to 0x18 (high)



Share Your Vision

	Down	8x 01 06 01 VV WW 03 02 FF	speed) WW: Tilt speed 0x01 (low speed) to 0x14 (high speed) YYYY: Pan Position ZZZZ: Tilt Position
	Left	8x 01 06 01 VV WW 01 03 FF	
	Right	8x 01 06 01 VV WW 02 03 FF	
	Upleft	8x 01 06 01 VV WW 01 01 FF	
	Upright	8x 01 06 01 VV WW 02 01 FF	
	DownLeft	8x 01 06 01 VV WW 01 02 FF	
	DownRight	8x 01 06 01 VV WW 02 02 FF	
	Stop	8x 01 06 01 VV WW 03 03 FF	
	AbsolutePosition	8x 01 06 02 VV WW 0Y 0Y 0Y 0Y 0Z 0Z 0Z 0Z FF	
	RelativePosition	8x 01 06 03 VV WW 0Y 0Y 0Y 0Y 0Z 0Z 0Z 0Z FF	
	Home	8x 01 06 04 FF	
	Reset	8x 01 06 05 FF	
Pan_tiltLimitSet	LimitSet	8x 01 06 07 00 0W 0Y 0Y 0Y 0Y 0Z 0Z 0Z 0Z FF	W: 1 UpRight 0: DownLeft YYYY: Pan Limit Position ZZZZ: Tilt Position
	LimitClear	8x 01 06 07 01 0W 07 0F 0F 0F 07 0F 0F 0F FF	
CAM_Brightness	Direct	8x 01 04 A1 00 00 0p 0q FF	pq: Brightness Position
CAM_Contrast	Direct	8x 01 04 A2 00 00 0p 0q FF	pq: Contrast Position
CAM_Flip	Off	8x 01 04 A4 00 FF	Single Command For Video Flip
	Flip-H	8x 01 04 A4 01 FF	
	Flip-V	8x 01 04 A4 02 FF	
	Flip-HV	8x 01 04 A4 03 FF	
CAM_SettingSave	Save	8x 01 04 A5 10 FF	Save Current Setting
CAM_AWBSensitivity	High	8x 01 04 A9 00 FF	High
	Normal	8x 01 04 A9 01 FF	Normal
	Low	8x 01 04 A9 02 FF	Low
CAM_AFZone	Top	8x 01 04 AA 00 FF	AF Zone weight select
	Center	8x 01 04 AA 01 FF	
	Bottom	8x 01 04 AA 02 FF	
CAM_ColorHue	Direct	8x 01 04 4F 00 00 00 0p FF	p: Color Hue 0h (-14 degrees) to Eh (+14 degrees)
OSD_Control	Open / Close	8x 01 04 3F 02 5F FF	
	Navigate Up	8x 01 06 01 0E 0E 03 01 FF	
	Navigate Down	8x 01 06 01 0E 0E 03 02 FF	
	Navigate Left	8x 01 06 01 0E 0E 01 03 FF	
	Navigate Right	8x 01 06 01 0E 0E 02 03 FF	
	Enter	8x 01 06 06 05 FF	
	Return	8x 01 06 06 04 FF	
CAM_NDIMode	High	8x 0B 01 01 FF	



Share Your Vision

	Medium	8x 0B 01 02 FF	
	Low	8x 0B 01 03 FF	
	Off	8x 0B 01 04 FF	
CAM_MulticastMode	Multicast Mode	8x 0B 01 23 0p FF	p=1: On, p=2: Off
CAM_PTZMotionSync	PTZ Motion Sync On	8x 0A 11 13 02 FF	
	PTZ Motion Sync Off	8x 0A 11 13 03 FF	
	MS Lower Speed Limit	8x 0A 11 14 pq FF	pq: speed stage
CAM_UACStatus	Toggle USB Audio	8x 2A 02 A0 04 0p FF	p=2: On, p=3: Off

### Part 3: VISCA Query Command List

Inquiry Command List			
Command	Command packed	Inquiry Packet	Comments
CAM_PowerInq	8x 09 04 00 FF	y0 50 02 FF	On
		y0 50 03 FF	Off (Standby)
		y0 50 04 FF	Internal power circuit error
CAM_ZoomPosInq	8x 09 04 47 FF	y0 50 0p 0q 0r 0s FF	pqrs: Zoom Position
CAM_FocusAFMode Inq	8x 09 04 38 FF	y0 50 02 FF	Auto Focus
		y0 50 03 FF	Manual Focus
CAM_FocusPosInq	8x 09 04 48 FF	y0 50 0p 0q 0r 0s FF	pqrs: Focus Position
CAM_WBModeInq	8x 09 04 35 FF	y0 50 00 FF	Auto
		y0 50 01 FF	Indoor mode
		y0 50 02 FF	Outdoor mode
		y0 50 03 FF	OnePush mode
		y0 50 05 FF	Manual
		y0 50 20 FF	ColorTemperature Mode
CAM_RGainInq	8x 09 04 43 FF	y0 50 00 00 0p 0q FF	pq: R Gain
CAM_BGainInq	8x 09 04 44 FF	y0 50 00 00 0p 0q FF	pq: B Gain
CAM_AEModeInq	8x 09 04 39 FF	y0 50 00 FF	Full Auto
		y0 50 03 FF	Manual
		y0 50 0A FF	Shutter priority
		y0 50 0B FF	Iris priority
		y0 50 0D FF	Bright
CAM_ShutterPosInq	8x 09 04 4A FF	y0 50 00 00 0p 0q FF	pq: Shutter Position
CAM_IrisPosInq	8x 09 04 4B FF	y0 50 00 00 0p 0q FF	pq: Iris Position
CAM_BrightPosInq	8x 09 04 4D FF	y0 50 00 00 0p 0q FF	pq: Bright Position
CAM_ExpCompModeInq	8x 09 04 3E FF	y0 50 02 FF	On
		y0 50 03 FF	Off
CAM_ExpCompPosInq	8x 09 04 4E FF	y0 50 00 00 0p 0q FF	pq: ExpComp Position



Share Your Vision

CAM_BacklightMode Inq	8x 09 04 33 FF	y0 50 02 FF	On
		y0 50 03 FF	Off
CAM_Nosise2DMode Ing	8x 09 04 50 FF	y0 50 02 FF	Auto Noise 2D
		y0 50 03 FF	Manual Noise 3D
CAM_Nosise2DLevel	8x 09 04 53 FF	y0 50 0p FF	Noise Reduction (2D) p: 0 to 5
CAM_Noise3DLevel	8x 09 04 54 FF	y0 50 0p FF	Noise Reduction (3D) p: 0 to 8
CAM_FlickerModeIn q	8x 09 04 55 FF	y0 50 0p FF	p: Flicker Settings(0: OFF, 1: 50Hz, 2: 60Hz)
CAM_ApertureModel nq (Sharpness)	8x 09 04 05 FF	y0 50 02 FF	Auto Sharpness
		y0 50 03 FF	Manual Sharpness
CAM_ApertureInq (Sharpness)	8x 09 04 42 FF	y0 50 00 00 0p 0q FF	pq: Aperture Gain
SYS_MenuModeInq	8x 09 06 06 FF	y0 50 02 FF	On
		y0 50 03 FF	Off
CAM_PictureEffectM odeInq	8x 09 04 63 FF	y0 50 02 FF	Off
		y0 50 04 FF	B&W
CAM_LR_ReverseInq	8x 09 04 61 FF	y0 50 02 FF	On
		y0 50 03 FF	Off
CAM_PictureFlipInq	8x 09 04 66 FF	y0 50 02 FF	On
		y0 50 03 FF	Off
CAM_ColorGainInq	8x 09 04 49 FF	y0 50 00 00 00 0p FF	p: Color Gain setting 0h (60%) to Eh (200%)
Pan-tiltPosInq	8x 09 06 12 FF	y0 50 0w 0w 0w 0w 0z 0z 0z 0z FF	www: Pan Position zzz: Tilt Position
CAM_GainLimitInq	8x 09 04 2C FF	y0 50 0q FF	p: Gain Limit
CAM_AFSensitivityI nq	8x 09 04 58 FF	y0 50 01 FF	High
		y0 50 02 FF	Normal
		y0 50 03 FF	Low
CAM_BrightnessInq	8x 09 04 A1 FF	y0 50 00 00 0p 0q FF	pq: Brightness Position
CAM_ContrastInq	8x 09 04 A2 FF	y0 50 00 00 0p 0q FF	pq: Contrast Position
CAM_FlipInq	8x 09 04 A4 FF	y0 50 00 FF	Off
		y0 50 01 FF	Flip-H
		y0 50 02 FF	Flip-V
		y0 50 03 FF	Flip-HV
CAM_AFZone	8x 09 04 AA FF	y0 50 00 FF	Top
		y0 50 01 FF	Center
		y0 50 02 FF	Bottom
CAM_ColorHueInq	8x 09 04 4F FF	y0 50 00 00 00 0p FF	p: Color Hue setting 0h (- 14 degrees) to Eh (+14 degrees)





Share Your Vision

CAM_AWBSensitivityInq	8x 09 04 A9 FF	y0 50 00 FF	High
		y0 50 01 FF	Normal
		y0 50 02 FF	Low
CAM_UACInq	8x 2A 02 A0 04 FF	y0 50 02 FF	On
		y0 50 03 FF	Off

Block Inquiry Command List			
Command	Command packed	Inquiry Packet	Comments
CAM_LensBlockInq	8x 09 7E 7E 00 FF	y0 50 0u 0u 0u 0u 00 00 0v 0v 0v 0v 00 0w 00 FF	uuuu: Zoom Position vvvv: Focus Position w.bit0: Focus Mode 1: Auto 0: Manual
CAM_CameraBlockInq	8x 09 7E 7E 01 FF	y0 50 0p 0p 0q 0q 0r 0s tt 0u vv ww 00 xx 0z FF	pp: R_Gain qq: B_Gain r: WB Mode s: Aperture tt: AE Mode u.bit2: Back Light u.bit1: Exposure Comp. vv: Shutter Position ww: Iris Position xx: Bright Position z: Exposure Comp. Position
CAM_OtherBlockInq	8x 09 7E 7E 02 FF	y0 50 0p 0q 00 0r 00 00 00 00 00 00 00 00 00 FF	p.bit0: Power 1:On, 0:Off q.bit2: LR Reverse 1:On, 0:Off r.bit3~0: Picture Effect Mode
CAM_EnlargementBlockInq	8x 09 7E 7E 03 FF	y0 50 00 00 00 00 00 00 0p 0q rr 0s 0t 0u FF	p: AF sensitivity q.bit0: Picture flip(1:On, 0:Off) rr.bit6~3: Color Gain(0h(60%) to Eh(200%)) s: Flip(0: Off, 1:Flip-H, 2:Flip-V, 3:Flip-HV) t.bit2~0: NR2D Level u: Gain Limit

Note: The [x] in the above table is the camera address, [y] = [x + 8].

**Part 4: VISCA over IP Command List**

Command	Function	Command Packet	Comments
CAM_Power	On	81 01 04 00 02 FF	Power ON/OFF
	Off	81 01 04 00 03 FF	
CAM_Zoom	Stop	81 01 04 07 00 FF	
	Tele (Standard)	81 01 04 07 02 FF	
	Wide (Standard)	81 01 04 07 03 FF	
	Tele (Variable)	81 01 04 07 2p FF	p = 0(low) - 7(high)
	Wide (Variable)	81 01 04 07 3p FF	
	Direct	81 01 04 47 0p 0q 0r 0s FF	pqrs: Zoom Position
CAM_Focus	Stop	81 01 04 08 00 FF	
	Far (Standard)	81 01 04 08 02 FF	
	Near (Standard)	81 01 04 08 03 FF	
	Far (Variable)	81 01 04 08 2p FF	p = 0(low) - 7(high)
	Near (Variable)	81 01 04 08 3p FF	
	Direct	81 01 04 48 0p 0q 0r 0s FF	pqrs: Focus Position
	Auto Focus	81 01 04 38 02 FF	AF On/Off
	Manual Focus	81 01 04 38 03 FF	
	Auto/Manual	81 01 04 38 10 FF	
	Focus Lock	81 0a 04 68 02 FF	Prevents any other operation or command from adjusting the current focus state
Focus Unlock	81 0a 04 68 03 FF		
CAM_WB	Auto	81 01 04 35 00 FF	Normal Auto
	Indoor mode	81 01 04 35 01 FF	Indoor mode
	Outdoor mode	81 01 04 35 02 FF	Outdoor mode
	OnePush mode	81 01 04 35 03 FF	One Push WB mode
	Manual	81 01 04 35 05 FF	Manual Control mode
	Color Temperature	81 01 04 35 20 FF	Color Temperature mode
	OnePush trigger	81 01 04 10 05 FF	One Push WB Trigger
CAM_RGain	Reset	81 01 04 03 00 FF	Manual Control of R Gain
	Up	81 01 04 03 02 FF	
	Down	81 01 04 03 03 FF	
	Direct	81 01 04 43 00 00 0p 0q FF	pq: R Gain
CAM_Bgain	Reset	81 01 04 04 00 FF	Manual Control of B Gain
	Up	81 01 04 04 02 FF	
	Down	81 01 04 04 03 FF	
	Direct	81 01 04 44 00 00 0p 0q FF	pq: B Gain
CAM_ColorTemp	Reset	81 01 04 20 00 FF	Default ColorTemperature setting
	Up	81 01 04 20 02 FF	
	Down	81 01 04 20 03 FF	

	Direct	81 01 04 20 0p 0q FF	pq: Color Temperature position 0x00: 2500K ~ 0x37: 8000K
CAM_AE	Full Auto	81 01 04 39 00 FF	Automatic Exposure mode
	Manual	81 01 04 39 03 FF	Manual Control mode
	Shutter priority	81 01 04 39 0A FF	Shutter Priority Automatic Exposure mode
	Iris priority	81 01 04 39 0B FF	Iris Priority Automatic Exposure mode
	Bright	81 01 04 39 0D FF	Bright Mode(Manual control)
CAM_Iris	Reset	81 01 04 0B 00 FF	Iris Setting
	Up	81 01 04 0B 02 FF	
	Down	81 01 04 0B 03 FF	
	Direct	81 01 04 4B 00 00 0p 0q FF	pq: Iris Position
CAM_Shutter	Reset	81 01 04 0A 00 FF	Default Shutter setting
	Up	81 01 04 0A 02 FF	
	Down	81 01 04 0A 03 FF	
	Direct	81 01 04 4A 00 00 0p 0q FF	pq: Shutter Position
CAM_Bright	Reset	81 01 04 0D 00 FF	Bright Setting
	Up	81 01 04 0D 02 FF	
	Down	81 01 04 0D 03 FF	
	Direct	81 01 04 0D 00 00 0p 0q FF	pq: Bright Position
CAM_ExpComp	On	81 01 04 3E 02 FF	Exposure Compensation On/Off
	Off	81 01 04 3E 03 FF	
	Reset	81 01 04 0E 00 FF	Exposure Compensation Amount Setting
	Up	81 01 04 0E 02 FF	
	Down	81 01 04 0E 03 FF	
	Direct	81 01 04 4E 00 00 0p 0q FF	pq: ExpComp Position
CAM_BackLight	On	81 01 04 33 02 FF	Back Light Compensation On/Off
	Off	81 01 04 33 03 FF	
CAM_Flicker	-	81 01 04 23 0p FF	p: Flicker Settings (0: Off, 1: 50Hz, 2: 60Hz)
CAM_PictureEffect	Off	81 01 04 63 00 FF	Picture Effect Setting
	B&W	81 01 04 63 04 FF	
CAM_Memory	Reset	81 01 04 3F 00 pp FF	pp: Memory Number (=0 to 127)
	Set	81 01 04 3F 01 pp FF	
	Recall	81 01 04 3F 02 pp FF	
Preset Recall Speed	Preset Speed	81 01 06 01 p FF	p: speed grade, the values are (0x01~0x18)
CAM_LR_Reverse	On	81 01 04 61 02 FF	Image Flip Horizontal On/Off
	Off	81 01 04 61 03 FF	
CAM_PictureFlip	On	81 01 04 66 02 FF	Image Flip Vertical On/Off
	Off	81 01 04 66 03 FF	
CAM_ColorGain	Direct	81 01 04 49 00 00 00 0p FF	p: Color Gain setting 0h (60%) to Eh (200%)
Pan_tiltDrive	Up	81 01 06 01 VV WW 03 01 FF	VV: Pan speed 0x01 (low speed) to 0x18 (high



Share Your Vision

	Down	81 01 06 01 VV WW 03 02 FF	speed) WW: Tilt speed 0x01 (low speed) to 0x14 (high speed) YYYY: Pan Position ZZZZ: Tilt Position
	Left	81 01 06 01 VV WW 01 03 FF	
	Right	81 01 06 01 VV WW 02 03 FF	
	Upleft	81 01 06 01 VV WW 01 01 FF	
	Upright	81 01 06 01 VV WW 02 01 FF	
	DownLeft	81 01 06 01 VV WW 01 02 FF	
	DownRight	81 01 06 01 VV WW 02 02 FF	
	Stop	81 01 06 01 VV WW 03 03 FF	
	AbsolutePosition	81 01 06 02 VV WW 0Y 0Y 0Y 0Y 0Z 0Z 0Z 0Z FF	
	RelativePosition	81 01 06 03 VV WW 0Y 0Y 0Y 0Y 0Z 0Z 0Z 0Z FF	
	Home	81 01 06 04 FF	
	Reset	81 01 06 05 FF	
Pan_tiltLimitSet	LimitSet	81 01 06 07 00 0W 0Y 0Y 0Y 0Y 0Z 0Z 0Z 0Z FF	W: 1 UpRight 0: DownLeft YYYY: Pan Limit Position ZZZZ: Tilt Position
	LimitClear	81 01 06 07 01 0W 07 0F 0F 0F 07 0F 0F 0F FF	
CAM_Brightness	Direct	81 01 04 A1 00 00 0p 0q FF	pq: Brightness Position
CAM_Contrast	Direct	81 01 04 A2 00 00 0p 0q FF	pq: Contrast Position
CAM_Flip	Off	81 01 04 A4 00 FF	Single Command For Video Flip
	Flip-H	81 01 04 A4 01 FF	
	Flip-V	81 01 04 A4 02 FF	
	Flip-HV	81 01 04 A4 03 FF	
CAM_SettingSave	Save	81 01 04 A5 10 FF	Save Current Setting
CAM_AWBSensitivity	High	81 01 04 A9 00 FF	High
	Normal	81 01 04 A9 01 FF	Normal
	Low	81 01 04 A9 02 FF	Low
CAM_AFZone	Top	81 01 04 AA 00 FF	AF Zone weight select
	Center	81 01 04 AA 01 FF	
	Bottom	81 01 04 AA 02 FF	
CAM_ColorHue	Direct	81 01 04 4F 00 00 00 0p FF	p: Color Hue 0h (-14 degrees) to Eh (+14 degrees)
OSD_Control	Open / Close	81 01 04 3F 02 5F FF	
	Navigate Up	81 01 06 01 0E 0E 03 01 FF	
	Navigate Down	81 01 06 01 0E 0E 03 02 FF	
	Navigate Left	81 01 06 01 0E 0E 01 03 FF	
	Navigate Right	81 01 06 01 0E 0E 02 03 FF	
	Enter	81 01 06 06 05 FF	
	Return	81 01 06 06 04 FF	
CAM_NDIMode	High	81 0B 01 01 FF	



Share Your Vision

	Medium	81 0B 01 02 FF	
	Low	81 0B 01 03 FF	
	Off	81 0B 01 04 FF	
CAM_MulticastMode	Multicast Mode	81 0B 01 23 0p FF	p=1: On, p=2: Off
CAM_PTZMotionSync	PTZ Motion Sync On	81 0A 11 13 02 FF	
	PTZ Motion Sync Off	81 0A 11 13 03 FF	
	MS Lower Speed Limit	81 0A 11 14 pq FF	pq: speed stage
CAM_UACStatus	Toggle USB Audio	81 2A 02 A0 04 0p FF	p=2: On, p=3: Off

### Part 5: VISCA over IP Query Command List

Inquiry Command List			
Command	Command packed	Inquiry Packet	Comments
CAM_PowerInq	81 09 04 00 FF	90 50 02 FF	On
		90 50 03 FF	Off (Standby)
		90 50 04 FF	Internal power circuit error
CAM_ZoomPosInq	81 09 04 47 FF	90 50 0p 0q 0r 0s FF	pqrs: Zoom Position
CAM_FocusAFMode Inq	81 09 04 38 FF	90 50 02 FF	Auto Focus
		90 50 03 FF	Manual Focus
CAM_FocusPosInq	81 09 04 48 FF	90 50 0p 0q 0r 0s FF	pqrs: Focus Position
CAM_WBModeInq	81 09 04 35 FF	90 50 00 FF	Auto
		90 50 01 FF	Indoor mode
		90 50 02 FF	Outdoor mode
		90 50 03 FF	OnePush mode
		90 50 05 FF	Manual
		90 50 20 FF	ColorTemperature Mode
CAM_RGainInq	81 09 04 43 FF	90 50 00 00 0p 0q FF	pq: R Gain
CAM_BGainInq	81 09 04 44 FF	90 50 00 00 0p 0q FF	pq: B Gain
CAM_AEModeInq	81 09 04 39 FF	90 50 00 FF	Full Auto
		90 50 03 FF	Manual
		90 50 0A FF	Shutter priority
		90 50 0B FF	Iris priority
		90 50 0D FF	Bright
CAM_ShutterPosInq	81 09 04 4A FF	90 50 00 00 0p 0q FF	pq: Shutter Position
CAM_IrisPosInq	81 09 04 4B FF	90 50 00 00 0p 0q FF	pq: Iris Position
CAM_BrightPosInq	81 09 04 4D FF	90 50 00 00 0p 0q FF	pq: Bright Position
CAM_ExpCompModeInq	81 09 04 3E FF	90 50 02 FF	On
		90 50 03 FF	Off
CAM_ExpCompPosInq	81 09 04 4E FF	90 50 00 00 0p 0q FF	pq: ExpComp Position



Share Your Vision

CAM_BacklightMode Inq	81 09 04 33 FF	90 50 02 FF	On
		90 50 03 FF	Off
CAM_Nosise2DMode Ing	81 09 04 50 FF	90 50 02 FF	Auto Noise 2D
		90 50 03 FF	Manual Noise 3D
CAM_Nosise2DLevel	81 09 04 53 FF	90 50 0p FF	Noise Reduction (2D) p: 0 to 5
CAM_Noise3DLevel	81 09 04 54 FF	90 50 0p FF	Noise Reduction (3D) p: 0 to 8
CAM_FlickerModeIn q	81 09 04 55 FF	90 50 0p FF	p: Flicker Settings(0: OFF, 1: 50Hz, 2: 60Hz)
CAM_ApertureModel nq (Sharpness)	81 09 04 05 FF	90 50 02 FF	Auto Sharpness
		90 50 03 FF	Manual Sharpness
CAM_ApertureInq (Sharpness)	81 09 04 42 FF	90 50 00 00 0p 0q FF	pq: Aperture Gain
SYS_MenuModeInq	81 09 06 06 FF	90 50 02 FF	On
		90 50 03 FF	Off
CAM_PictureEffectM odeInq	81 09 04 63 FF	90 50 02 FF	Off
		90 50 04 FF	B&W
CAM_LR_ReverseInq	81 09 04 61 FF	90 50 02 FF	On
		90 50 03 FF	Off
CAM_PictureFlipInq	81 09 04 66 FF	90 50 02 FF	On
		90 50 03 FF	Off
CAM_ColorGainInq	81 09 04 49 FF	90 50 00 00 00 0p FF	p: Color Gain setting 0h (60%) to Eh (200%)
Pan-tiltPosInq	81 09 06 12 FF	90 50 0w 0w 0w 0w 0z 0z 0z 0z FF	www: Pan Position zzzz: Tilt Position
CAM_GainLimitInq	81 09 04 2C FF	90 50 0q FF	p: Gain Limit
CAM_AFSensitivityI nq	81 09 04 58 FF	90 50 01 FF	High
		90 50 02 FF	Normal
		90 50 03 FF	Low
CAM_BrightnessInq	81 09 04 A1 FF	90 50 00 00 0p 0q FF	pq: Brightness Position
CAM_ContrastInq	81 09 04 A2 FF	90 50 00 00 0p 0q FF	pq: Contrast Position
CAM_FlipInq	81 09 04 A4 FF	90 50 00 FF	Off
		90 50 01 FF	Flip-H
		90 50 02 FF	Flip-V
		90 50 03 FF	Flip-HV
CAM_AFZone	81 09 04 AA FF	90 50 00 FF	Top
		90 50 01 FF	Center
		90 50 02 FF	Bottom
CAM_ColorHueInq	81 09 04 4F FF	90 50 00 00 00 0p FF	p: Color Hue setting 0h (- 14 degrees) to Eh (+14 degrees)

CAM_AWBSensitivityInq	81 09 04 A9 FF	90 50 00 FF	High
		90 50 01 FF	Normal
		90 50 02 FF	Low
CAM_UACInq	81 2A 02 A0 04 FF	90 50 02 FF	On
		90 50 03 FF	Off

### Part 6: Pelco-D Protocol Command List

Function	Byte1	Byte2	Byte3	Byte4	Byte5	Byte6	Byte7
Up	0xFF	Address	0x00	0x08	Pan Speed	Tilt Speed	SUM
Down	0xFF	Address	0x00	0x10	Pan Speed	Tilt Speed	SUM
Left	0xFF	Address	0x00	0x04	Pan Speed	Tilt Speed	SUM
Right	0xFF	Address	0x00	0x02	Pan Speed	Tilt Speed	SUM
Zoom In	0xFF	Address	0x00	0x20	0x00	0x00	SUM
Zoom Out	0xFF	Address	0x00	0x40	0x00	0x00	SUM
Focus Far	0xFF	Address	0x00	0x80	0x00	0x00	SUM
Focus Near	0xFF	Address	0x01	0x00	0x00	0x00	SUM
Set Preset	0xFF	Address	0x00	0x03	0x00	Preset ID	SUM
Clear Preset	0xFF	Address	0x00	0x05	0x00	Preset ID	SUM
Call Preset	0xFF	Address	0x00	0x07	0x00	Preset ID	SUM
Auto Focus	0xFF	Address	0x00	0x2B	0x00	0x01	SUM
Manual Focus	0xFF	Address	0x00	0x2B	0x00	0x02	SUM
Query Pan Position	0xFF	Address	0x00	0x51	0x00	0x00	SUM
Query Pan Position Response	0xFF	Address	0x00	0x59	Value High Byte	Value Low Byte	SUM
Query Tilt Position	0xFF	Address	0x00	0x53	0x00	0x00	SUM
Query Tilt Position Response	0xFF	Address	0x00	0x5B	Value High Byte	Value Low Byte	SUM
Query Zoom Position	0xFF	Address	0x00	0x55	0x00	0x00	SUM
Query Zoom Position Response	0xFF	Address	0x00	0x5D	Value High Byte	Value Low Byte	SUM

**Part 7: Pelco-P Protocol Command List**

Function	Byte1	Byte2	Byte3	Byte4	Byte5	Byte6	Byte7	Byte8
Up	0xA0	Address	0x00	0x08	Pan Speed	Tilt Speed	0xAF	XOR
Down	0xA0	Address	0x00	0x10	Pan Speed	Tilt Speed	0xAF	XOR
Left	0xA0	Address	0x00	0x04	Pan Speed	Tilt Speed	0xAF	XOR
Right	0xA0	Address	0x00	0x02	Pan Speed	Tilt Speed	0xAF	XOR
Zoom In	0xA0	Address	0x00	0x20	0x00	0x00	0xAF	XOR
Zoom Out	0xA0	Address	0x00	0x40	0x00	0x00	0xAF	XOR
Focus Far	0xA0	Address	0x00	0x80	0x00	0x00	0xAF	XOR
Focus Near	0xA0	Address	0x01	0x00	0x00	0x00	0xAF	XOR
Set Preset	0xA0	Address	0x00	0x03	0x00	Preset ID	0xAF	XOR
Clear Preset	0xA0	Address	0x00	0x05	0x00	Preset ID	0xAF	XOR
Call Preset	0xA0	Address	0x00	0x07	0x00	Preset ID	0xAF	XOR
Auto Focus	0xA0	Address	0x00	0x2B	0x00	0x01	0xAF	XOR
Manual Focus	0xA0	Address	0x00	0x2B	0x00	0x02	0xAF	XOR
Query Pan Position	0xA0	Address	0x00	0x51	0x00	0x00	0xAF	XOR
Query Pan Position Response	0xA0	Address	0x00	0x59	Value High Byte	Value Low Byte	0xAF	XOR
Query Tilt Position	0xA0	Address	0x00	0x53	0x00	0x00	0xAF	XOR
Query Tilt Position Response	0xA0	Address	0x00	0x5B	Value High Byte	Value Low Byte	0xAF	XOR
Query Zoom Position	0xA0	Address	0x00	0x55	0x00	0x00	0xAF	XOR
Query Zoom Position Response	0xA0	Address	0x00	0x5D	Value High Byte	Value Low Byte	0xAF	XOR



## Menu Settings

### 1. MENU

Press the [MENU] button to display the On Screen Display menu on the normal screen, using the arrow button to move the cursor to the item to be set. Press the [HOME] button to enter the corresponding sub-menu.

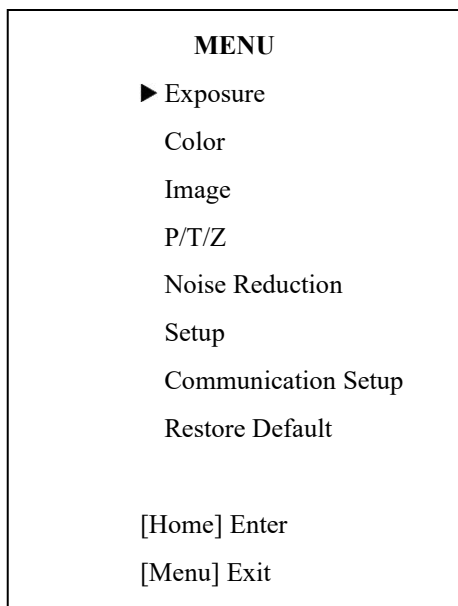

### 2. EXPOSURE

Move the main menu cursor to [EXPOSURE], and press the [HOME] key to enter the exposure page, as shown in the following figure.

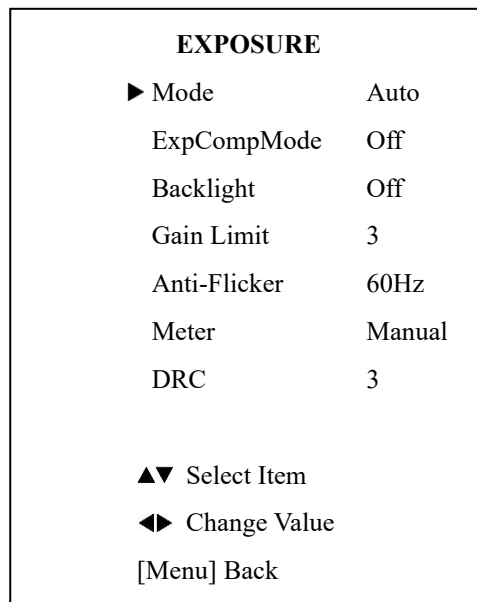

**Exposure Mode:** Modes include: Auto, Manual, SAE, AAE, Bright

**ExpCompMode:** Exposure compensation mode, optional items: On, Off (Effective only in Auto mode).

**ExpComp:** Exposure compensation value, optional items: -7~7 (Effective only when ExpCompMode is On).

**Backlight:** Set the backlight compensation, optional items: On, Off (Effective only in Auto mode).

**Bright:** Intensity control, optional items: 00 ~ 17 (Effective only in Bright mode).

**Gain Limit:** Maximum gain limit, optional items: 0 ~ 15 (Effective only in SAE, AAE, & Bright mode).

**Anti-Flicker:** Anti-flicker, optional items: Off, 50Hz, 60Hz (Effective only in Auto, AAE, & Bright mode).

**Shutter:** Shutter value, optional items: 1/30, 1/60, 1/90, 1/100, 1/125, 1/180, 1/250, 1/350, 1/500, 1/725, 1/1000, 1/1500, 1/2000, 1/3000, 1/4000, 1/6000, 1/10000 (Effective only in SAE & Manual mode).

**DRC:** Dynamic Range Control strength, optional items: 0 ~ 8.

### 3. COLOR

Move the main menu cursor to [COLOR], and press the [HOME] key to enter the color page, as shown in the following figure.

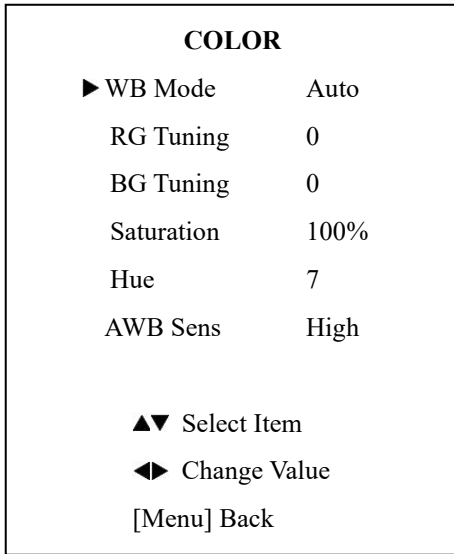

**WB-Mode:** Modes include: Auto, Indoor, Outdoor, One Push, Manual, VAR.

**R Gain:** Red gain, optional items: 0~255  
(Effective only in Manual mode).

**B Gain:** Blue gain, optional items: 0~255  
(Effective only in Manual mode).

**colortemp:** Optional items: 2500K ~ 8000K  
(Effective only in VAR mode).

**RG Tuning:** Red gain tuning, optional items: -10 ~ +10.

**BG Tuning:** Blue gain tuning, optional items: -10 ~ +10.

**Saturation:** optional items: 60% ~ 200%.

**Hue:** Chroma adjustment, optional items: 0 ~ 14.

**AWB Sens:** The white balance sensitivity, optional items: Low, Normal, High.

(Effective only in Auto & One Push mode)

### 4. IMAGE

Move the main menu cursor to [IMAGE], and press the [HOME] key to enter the image page, as shown in the following figure.

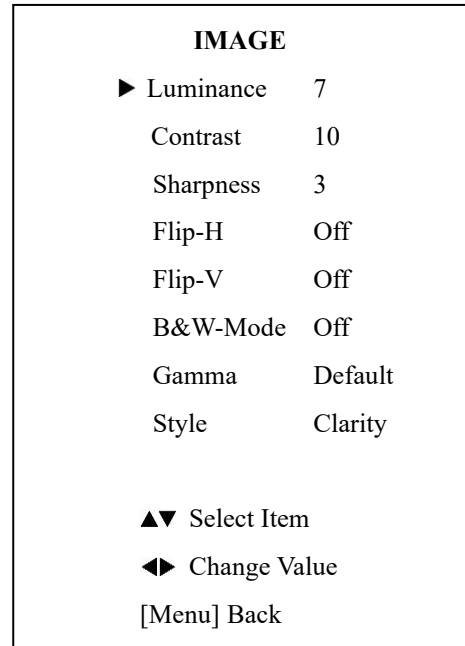

**Luminance:** Brightness adjustment, optional items: 0 ~ 14.

**Contrast:** Contrast adjustment, optional items: 0 ~ 14.

**Sharpness:** Sharpness adjustment, optional items: 0 ~ 14

**Flip-H:** Image flipped horizontally, optional items: On, Off.

**Flip-V:** Image Flip Vertical, optional items: On, Off.

**Gamma:** Optional items: Default, 0.45, 0.5, 0.56, 0.63.

**Style:** Optional items: Clarity, Norm, 5S, Soft, & Bright

### 5. P/T/Z

Move the main menu cursor to [P/T/Z], and press the [HOME] key to enter the P/T/Z page, as shown in the following figure.

P/T/Z	
▶ SpeedByZoom	On
AF-Zone	Center
AF-Sense	High
L/R Set	STD
Display Info	On
Image Freeze	Off
Digital Zoom	Off
Call Preset Speed	12
Pre Zoom Speed	5
▲▼ Select Item	
◀▶ Change Value	
[Menu] Back	

NOISE REDUCTION	
▶ NR2D-Level 1	
NR3D-Level 3	
▲▼ Select Item	
◀▶ Change Value	
[Menu] Back	

**SpeedByZoom:** The depth of field scale switch, optional items: On, Off

**AF-Zone:** Interested in focusing area, optional items: Top, Center, Bottom

**AF-Sense:** Automatic focusing sensitivity options, optional items: Low, Normal, High

**L/R Set:** Optional items: STD, REV

**Display Info:** Displays camera information upon startup, optional items: On, Off

**Image Freeze:** Temporarily freeze image during preset call, optional items: On, Off

**Digital Zoom:** Increase zoom level with electronic zoom, optional items: Off, 2x, 4x, 8x, 16x

**Call Preset Speed:** Preset call speed, optional items: 1 ~ 24

**Pre Zoom Speed:** Preset Zoom Speed, optional items: 0 ~ 7

## 6. NOISE REDUCTION

Move the main menu cursor to [NOISE REDUCTION], and press the [HOME] key to enter the noise reduction page, as shown in the following figure.

**NR2D Level:** 2D noise reduction, optional items: Close, Auto, 1 ~ 5.

**NR3D Level:** 3D noise reduction, optional items: Off, 1 ~ 8.

## 7. SETUP

Move the main menu cursor to [SETUP], and press the [HOME] key to enter the setup page, as shown in the following figure.

SETUP	
▶ Language	EN
DVIMode	HDMI
Lens	Type2
Auto Scan Shoot	Off
Auto Focus L	Off
OSD TimeOut	2.5min
MotionSync	Off
Focus Limit	Off
Pre Zoom Speed	5
▲▼ Select Item	
◀▶ Change Value	
[Menu] Back	

**Language:** Optional items: EN, Chinese, Russian, French, Spanish, Italian, German

**DVIMode:** HDMI Data Transfer type, options include: HDMI, DVI

**Lens:** Optional items: Type1, Type2

**Auto Scan Shoot:** optional items: Off, On

**Auto Focus L:** Lock focus in current position, optional items: Off, On

**OSD TimeOut:** Auto close OSD, optional items: 2.5min, Off

**MotionSync:** Trisynchronous preset call, optional items: Off, On

**Max Speed:** Maximum MotionSync Speed, optional items: 185 – 230 (Effective only when MotionSync is “On”)

**Focus Limit:** Set a focus range, optional items: Off, On

**Furthest Position:** Set the furthest focus distance, optional items: INF, 1m ~ 20m (Effective only when FocusLimit is “On”)

**Nearest Position:** Set the nearest focus distance, optional items: INF, 1m ~ 20m (Effective only when FocusLimit is “On”)

## 8. COMMUNICATION SETUP

Move the main menu cursor to [INFORMATION], and press the [HOME] key to enter the communication setup page, as shown in the following figure.

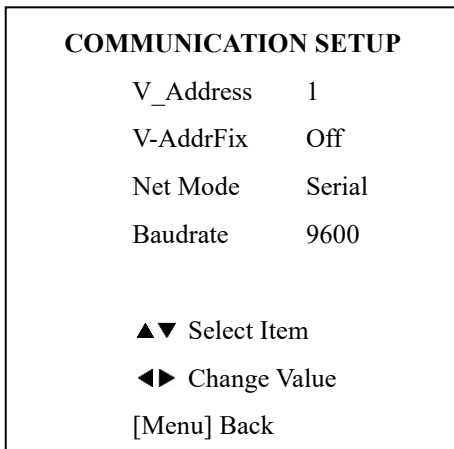

**V\_Address:** Camera VISCA address: optional items: 1 ~ 7

**V-AddrFix:** Fixed VISCA address: optional items: Off, On

**Net Mode:** Optional items: Serial, Paral

**Baudrate:** Optional items: 2400, 4800, 9600, 38400

**P\_D\_Address:** Pelco-D Address, optional items: 0 - 254

**P\_P\_Address:** Pelco-P Address, optional items: 0 - 31

## 9. RESTORE DEFAULT

Move the main menu cursor to [RESTORE DEFAULT], and press the [HOME] key to enter the restore default page, as shown in the following figure.

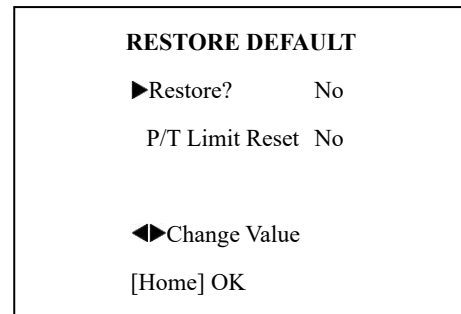

**Restore?:** Confirm restore factory settings, optional items: Yes, No.

**P/T Limit Reset:** Confirm P/T Limit Reset, optional items: Yes, No.

Note: Press [HOME] button to confirm, all parameter restore default, include IR Remote address and VISCA address.

## Network Connection

### 1. Operating Environment

Operating System: Windows 2000/2003/XP/Vista/7/8.1/10

Network Protocol: TCP/IP

Client PC: P4 / 128M RAM / 40GHD / support for scaled graphics card, support for DirectX8.0 or more advanced version.

### 2. Equipment Installation

1) Connect camera to your network via a CAT5 or CAT6 patch cable or directly to your PC via a CAT5 or CAT6 cross over cable.

2) Turn on camera power.

3) If successful, the orange network light will illuminate and the green light will start flashing. If unsuccessful, the cable is bad, you are using the wrong cable, or you have connected to an inactive network jack.

### 3. Network Connection

Connection method between network camera and computer, as in pictures 1.1 and 1.2, below:

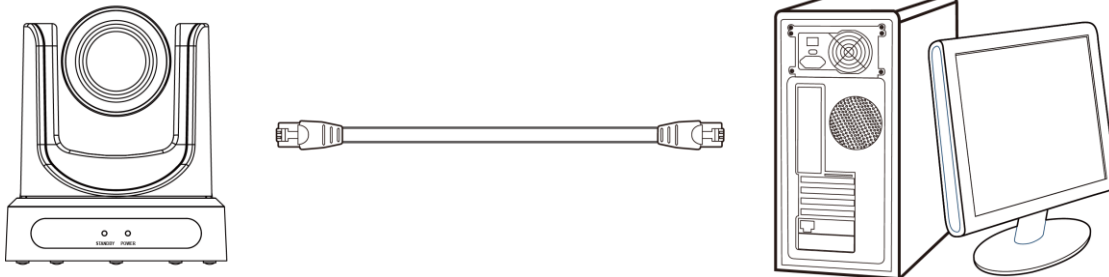

**Picture 1.1 Direct connections via “cross-over” network cable**

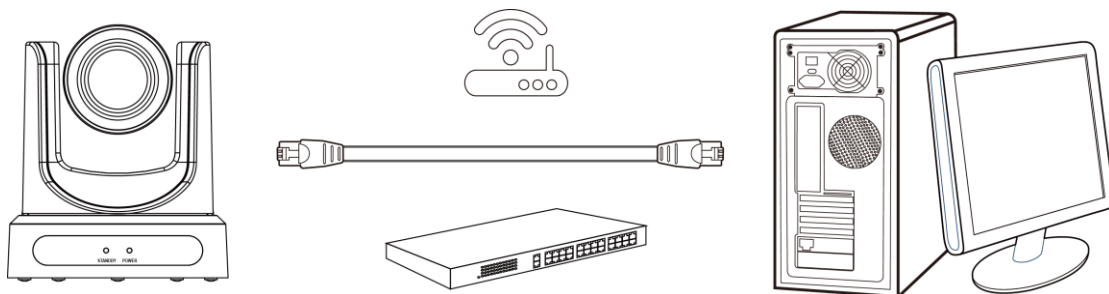

**Picture 1.2 Connections to LAN via patch cable to LAN wall jack or LAN switch**

## Setting up a Network Video Stream

1. The first thing you are going to want to do to get your camera up and streaming on your network is to connect your camera to power, an active network port on your network, and finally, power on the camera.
2. Next, go online and download the IP Address Settings Tool. It's available for Windows & Mac OS at [ptzoptics.com/download](http://ptzoptics.com/download).
3. Once you complete the download, launch the “Upgrade v2.8C” tool. Select your network connection type from the “Interface” dropdown menu and click “Search”.

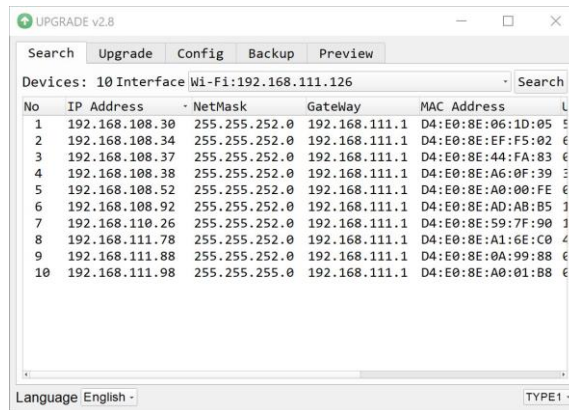

4. The next thing you would want to do is change your cameras IP address to be in the same range as your network. The camera comes with a default IP address of 192.168.100.99.
  - a. See the “Additional Network Info” section to identify your network scheme.
5. Right-click on the camera you wish to change the IP address of and select “Config”.
  - a. You have two (2) options for assigning the IP address of your camera. You can manually assign the IP address by assigning a static IP address, or you can have a DHCP server automatically assign a dynamic IP address to your camera.
  - b. Note: In more complex network environments, you may need to request a static IP address, Network Mask, Default Gateway, & First DNS from your IT department.

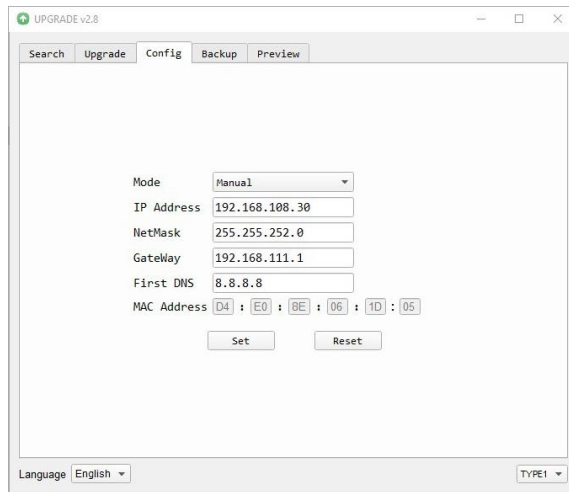

6. After assigning an IP address to the camera, you can reach the Web Interface by typing in the camera's IP address into a web browser. To log in, type in "admin" into the username and password fields.  
From the Web Interface, you have two (2) ways to view the video feed.
  - a. Set the secondary stream to MJPEG.
  - b. Install the PTZOptics ActiveX Plugin and use Internet Explorer.
    - i. For more detail, go to [help.ptzoptics.com](http://help.ptzoptics.com).
7. From the Web Interface, you can control the camera using the arrows on the left side. You can also adjust many of your camera's settings via this IP interface.
8. You can now receive an RTSP stream from your camera. To view the RTSP stream, type in "rtsp://[Camera IP address]:554/1" for the first (HD) stream, and "rtsp://[Camera IP address]:554/2" for the second (SD) stream.
9. You can test the RTSP streaming in VLC Media Player. Once VLC is installed and launched, click the "Media" drop down menu and select "Open Network Stream"

## Additional Network Info

### Discovering your Network IP range

You can discover the IP range of your network by using the Command Prompt for Windows, or the Terminal app for Macs and following the steps below.

#### Windows

1. Type “CMD” into the search bar in the start menu.
2. Type in “ipconfig” and press “Enter” on your keyboard.
3. Scroll down to “IPv4 Address”. This is your computer’s local IP address.

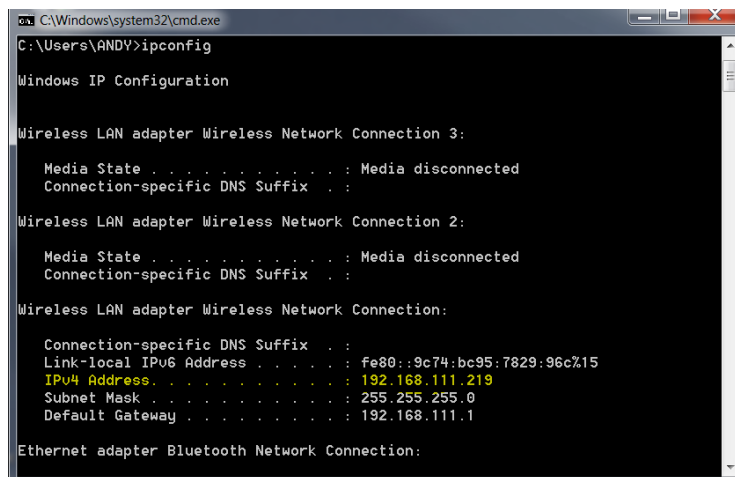

```
C:\Windows\system32\cmd.exe
C:\Users\ANDY>ipconfig

Windows IP Configuration

Wireless LAN adapter Wireless Network Connection 3:

    Media State . . . . . : Media disconnected
    Connection-specific DNS Suffix  . :

Wireless LAN adapter Wireless Network Connection 2:

    Media State . . . . . : Media disconnected
    Connection-specific DNS Suffix  . :

Wireless LAN adapter Wireless Network Connection:

    Connection-specific DNS Suffix  . :
    Link-local IPv6 Address . . . . . : fe80::9c74:bc95:7829:96c%15
    IPv4 Address. . . . . : 192.168.111.219
    Subnet Mask . . . . . : 255.255.255.0
    Default Gateway . . . . . : 192.168.111.1

Ethernet adapter Bluetooth Network Connection:
```

4. In the example above, the PC’s local address is “192.168.111.219”, making the IP range “192.168.111”.

#### Mac

1. Open a new finder window and go to Applications, then Utilities, and select the Terminal program.
2. Type in “IP config get if addr en0” and press “Enter” on your keyboard.

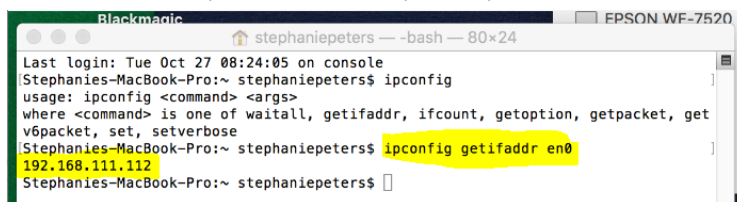

```
Blackmagic stephaniepeters — -bash — 80x24
Last login: Tue Oct 27 08:24:05 on console
Stephanies-MacBook-Pro:~ stephaniepeters$ ipconfig
usage: ipconfig <command> <args>
where <command> is one of waitall, getifaddr, ifcount, getoption, getpacket, get
v6packet, set, setverbose
Stephanies-MacBook-Pro:~ stephaniepeters$ ipconfig getifaddr en0
192.168.111.112
Stephanies-MacBook-Pro:~ stephaniepeters$
```

3. In the example above, the Mac’s local address is “192.168.111.112”, making the IP range “192.168.111”



## Camera Web Interface

The Web Interface allows you to control the camera, view the video feed, and adjust many of the camera’s settings.

### Menu

The Menu allows you to traverse the Web Interface. By default, the “Live” option is selected.

### Live

This tab allows you to view the video feed of the camera.

The status bar below the video feed can be used to pause / play the video feed, adjust the audio level, and switch between full screen and windowed view.

### Directional Arrows

Use the PTZ / OSD dropdown to select how the Directional Arrows behave. While “PTZ” is selected, you will have control over Pan, Tilt, and calling the Home position. When “OSD” is selected, the On Screen Display Menu will open, allowing you to use the Directional Arrows to traverse the OSD Menu.

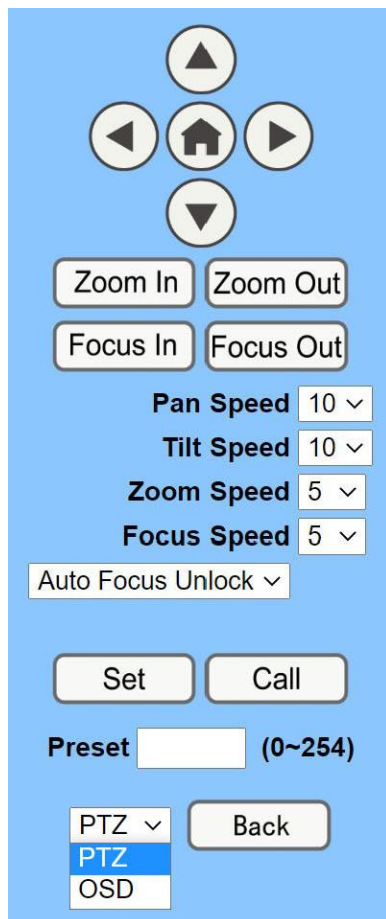

**Directional Arrows:** Use the Up / Down / Left / Right buttons to Pan / Tilt the camera or traverse the OSD Menu.

**Home Button:** Use the Home Button to send the camera to the Home position, or to make a selection within the OSD Menu.

**Zoom In:** Use the Zoom In button to for narrow (tele) views of the scene.

**Zoom Out:** Use the Zoom Out button for wide views of the scene.

**Focus In/Out:** Use the Focus In and Focus Out buttons to make manual focus adjustments of the scene.

**Speed Control:** Use the Pan, Tilt, Zoom, and Focus Speed dropdowns to adjust the speed at which you control the camera.

**Auto Focus Unlock:** Use the Auto Focus Unlock / Lock dropdown to manually lock the focus in the current position.

**PTZ Presets:** After manually positioning the camera in a position you wish to return to, you can save the position as a PTZ Preset. Type a number between 0~254 into the Preset box and press the “Set” button to save that position. Click the “Call” button to send the camera back to that PTZ Preset position.

**PTZ / OSD Dropdown:** Use the PTZ / OSD Dropdown to select Pan / Tilt / Zoom control, or On Screen Display Menu control.

## Video

**Video Settings**

720p120:  On  Off

Video Format:

Encode Level:

NDI Preset:

**First stream**

Encode Protocol:

Resolution:

Bit Rate:  (32~20480) kbps

Frame Rate:  fps

I Key Frame Interval:  (2~1200)

Bit Rate Control:  CBR  VBR

Fluctuate Level:

Slice Split Enable:  On  Off

Split Mode:  Fixed blocks  Fixed bytes

Slice Size:  blocks/bytes

**Second stream**

Encode Protocol:

Resolution:

Bit Rate:  (32~6144) kbps

Frame Rate:  fps

I Key Frame Interval:  (2~1200)

Bit Rate Control:  CBR  VBR

Fluctuate Level:

Slice Split Enable:  On  Off

Split Mode:  Fixed blocks  Fixed bytes

Slice Size:  blocks/bytes

**720p120:** Allows camera to output 720p at 120 FPS via the IP Network Stream. Set to ‘On’ or ‘Off’. (Note: Setting to ‘On’ will override and lockout other video settings).

**Video Format:** Supports 50Hz (PAL), 60Hz (NTSC), & Dial Priority formats.

**Encode Level:** Supports baseline, mainprofile, highprofile, & svc-t.

**NDI Preset:** Supports Off, High, Medium, & Low.

**Encode Protocol:** Supports H.264, H.265, and MJPEG protocols.

**Resolution:** The first stream supports: 1920x1080, 1280x720, 1024x576, 960x540, 640x480, 640x360.

The second stream supports: 1280x720, 1024x576, 720x480, 720x408, 640x360, 480x270, 320x240, 320x180

**Bit Rate:** Adjust the maximum bit rate of the network video. The higher the bit rate, the clearer the image will be. Bit rates set too high can congest the network and cause the video to not transmit properly, causing the video to appear worse. Range: 32 – 20480 kbps

**Frame Rate:** Adjust the frame rate of the network video. The higher the frame rate the smoother the video will appear.

**I-Key Frame Interval:** Adjust how frequently a keyframe is produced.

**Bit Rate Control:** Supports Constant bit rate (CBR) & Variable bit rate (VBR)

**Fluctuate Level:** Limit the fluctuation magnitude of variable rate. Supports 1 ~ 6.

**Split Mode Enable:** Enable / Disable splice split function.

**Split Mode:** Supports Fixed blocks and Fixed bytes.

**Slice Size:** Set the slice size.

## Image

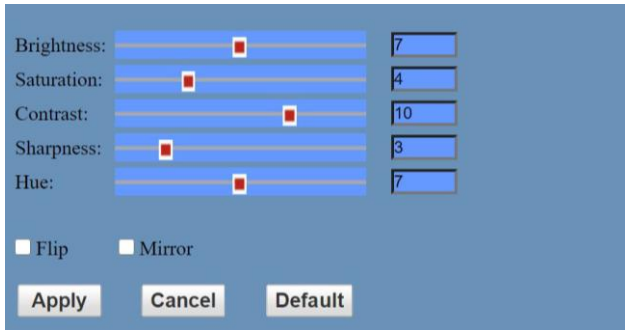

Brightness:  7

Saturation:  4

Contrast:  10

Sharpness:  3

Hue:  7

Flip  Mirror

Apply Cancel Default

**Brightness:** Brightness slider. Default: 7

**Saturation:** Saturation slider. Default: 4

**Contrast:** Contrast slider. Default 10

**Sharpness:** Sharpness slider. Default: 3

**Hue:** Hue slider. Default: 7

**Flip & Mirror:** Check the Flip and/or Mirror buttons to rotate the image accordingly.

## Audio

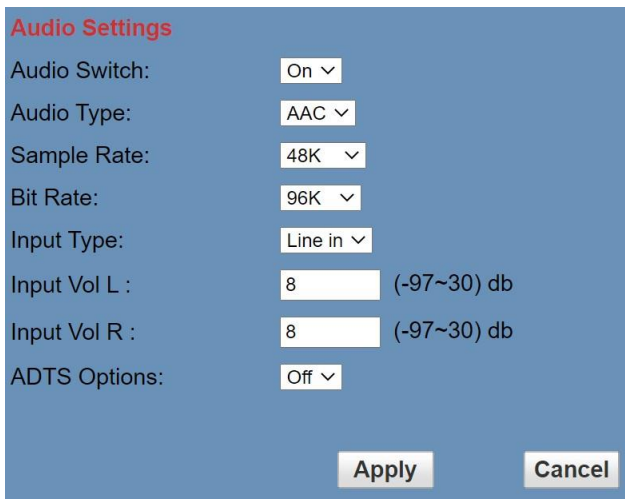

**Audio Settings**

Audio Switch: On ▾

Audio Type: AAC ▾

Sample Rate: 48K ▾

Bit Rate: 96K ▾

Input Type: Line in ▾

Input Vol L : 8 (-97~30) db

Input Vol R : 8 (-97~30) db

ADTS Options: Off ▾

Apply Cancel

**Audio Switch:** Enable / Disable audio embedding

**Audio Type:** AAC

**Sample Rate:** Options include: 44.1K & 48K

**Bit Rate:** Options include: 96K, 128K, & 256K

**Input Type:** Line in.

**Input Vol L:** Volume of left channel. -97 ~ 30 db

**Input Vol R:** Volume of right channel. -97 ~ 30 db

**ADTS Options:** Enable / Disable ADTS

## System

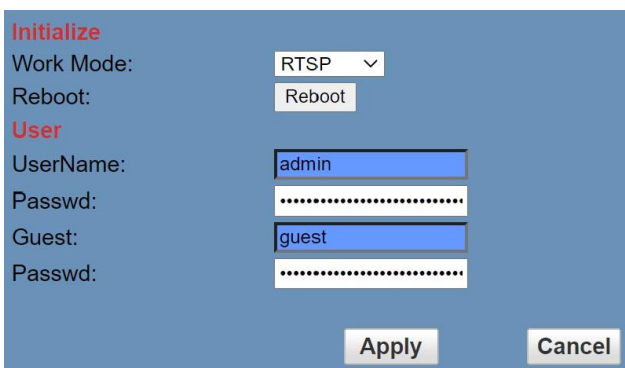

**Initialize**

Work Mode: RTSP ▾

Reboot: Reboot

**User**

UserName: admin

Passwd: .....

Guest: guest

Passwd: .....

Apply Cancel

**Work Mode:** Options include: RTSP, SDK, & Multicast.

**Reboot:** Used to power cycle the camera

**Username:** Username to login to device. Username: "admin".

**Password:** Password to login to device. Default password: "admin".

**Guest (Username):** Guest username to login to device. Username: "guest".

**Guest (Password):** Guest password to login to device. Default password: "guest".

## Network

**Lan Settings**

IP Configuration Type: Fixed IP Address

IP Address: 192.168.108.44

Subnet Mask: 255.255.252.0

Gateway: 192.168.111.1

DNS Address: 192.168.111.1

MAC Address: D4 : E0 : 8E : 01 : A6 : 98

Apply Cancel

**Port Settings**

HTTP Port number: 80 (80)

RTSP Port: 554 (554)

PTZ Port: 5678 (5678)

UDP Port: 1259 (1259)

Sony Visca: 52381

**SRT Settings**

SRT:  On  Off

SRT Port: 4578

SRT Encry: Off

SRT Password: 1234567891 (SRT Password length greater than 9 bits)

**Control Protocol Settings**

Pelco-D Address: 0 (0~254)

Pelco-P Address: 0 (0~31)

**RTMP(S) Settings**

First stream:  On  Off  Video  Audio

MRL: \_\_\_\_\_

Second stream:  On  Off  Video  Audio

MRL: \_\_\_\_\_

**RTSP Settings**

RTSP Auth:  On  Off

**ONVIF Settings**

ONVIF:  On  Off

ONVIF Auth:  On  Off

**Multicast Settings**

Multicast:  On  Off

Address: 224.1.2.3

Port: 6688

**SDK Settings**

Active Connection:  On  Off

Address: 192.168.100.138

Port: 1234

**NTP Settings**

time zone: (GMT-05:00) Eastern Time (US & Canada)

NTP time sync:  On  Off

Server address: 192.168.100.168

Time interval: 1440 minutes

Main time show:  On  Off

Position: X 0 Y 0 (0~100)

Sub time show:  On  Off

Position: X 0 Y 0 (0~100)

Apply Cancel

**LAN Settings:** The Lan Settings section allows you to adjust the IP parameters of the camera. The default IP address of the camera is 192.168.100.99. You cannot change the MAC address.

**IP Configuration Type:** Fixed IP Address (Static) & Dynamic IP Address (DHCP).

**IP Address:** Camera’s IP address.

**Subnet Mask:** Network Subnet Mask.

**Gateway:** Network Gateway.

**DNS Address:** Network Domain Name Server address.

**MAC Address:** The camera's MAC address.

**Apply & Cancel Buttons:** Apply or cancel the changes made to the LAN Settings section.

**Port Settings:** The Port Settings section allows you to adjust the network ports of the camera.

**HTTP Port:** This port is used for HTTP-CGI control, and for the web application. Default: 80.

**RTSP Port:** This port is used for the RTSP streaming protocol. Default 554.

**PTZ Port:** This port is used for the TCP/IP control protocol. Default: 5678.

**UDP Port:** This port is used for the UDP control protocol. Default: 1259

**Sony VISCA:** This port is used for the Sony VISCA protocol. You cannot change this port number.

**SRT Settings:** The Secure Reliable Transport protocol settings section allows you to adjust the SRT settings of the camera.

**SRT:** Enable / Disable SRT

**SRT Port:** This is the port used for the SRT protocol. Default: 4578.

**SRT Encry:** Enable / Disable SRT Encryption. Options include: Off, AES-128, AES-192, AES-256

**SRT Password:** Change the SRT Password when SRT Encryption is enabled. Default: 1234567891

**Control Protocol Settings:** The Control Protocol Settings section allows you to adjust the Pelco-D & Pelco-P control address.

**Pelco-D Address:** 0 ~ 254

**Pelco-P Address:** 0 ~ 31

**RTMP Settings:** The RTMP(S) Settings section allows you to enable or disable the two (2) RTMPS stream's video and audio sources.

**First Stream:** Enable / Disable Stream 1 Video & Audio

**(First Stream) MRL:** Text field for RTMPS Stream 1's Media Resource Locator (MRL)

**Second Stream:** Enable / Disable Stream 2 Video & Audio

**(Second Stream) MRL:** Text field for RTMPS Stream 2's Media Resource Locator (MRL)

**RTSP Settings:** The RTSP Settings section allows you to enable or disable RTSP Authorization.

**RTSP Auth.:** Enable / Disable RTSP authorization.

**ONVIF Settings:** The ONVIF Settings section allows you to adjust the ONVIF settings of the camera.

**ONVIF:** Enable / Disable ONVIF protocol control.

**ONVIF Auth.:** Enable / Disable ONVIF authorization.

**Multicast Settings:** The Multicast Settings section allows you to adjust the Multicast settings of the camera.

**Multicast:** Enable / Disable the Multicast protocol.

**Address:** Adjust the Multicast address.

**Port:** This port is used for the Multicast protocol. Default: 6688.

**SDK Settings:** The SDK Settings section allows you to adjust the Software Development Kit settings of the camera.

**Active Connection:** Enable / Disable the SDK active connection.

**Address:** This is the IP address field of the SDK. Default: 192.168.100.138

**Port:** This is the port used for the SDK. Default: 1234

**NTP Settings:** The NTP Settings section allows you to enable / disable the Network Time Protocol of the camera.

**Time Zone:** Adjust the time zone you wish to use with NTP.

**NTP Time Sync:** Enable / Disable NTP Time Sync

**Server Address:** Text field for NTP server.

**Time Interval:** Adjust the Time Interval in minutes. Default: 1440

**Main Time Show:** Enable / Disable Main Time

**Position:** Main Time position

**Sub Time Show:** Enable / Disable Sub Time

**Position:** Sub Time position

**Apply & Cancel Buttons:** Apply or cancel the changes made to the Network Settings section.

## Information

The Information section displays the device information, firmware version, & device friendly name. You can adjust the device friendly name as needed to designate the camera.

## Language

The Language selection dropdown allows you to change the language of the Web Interface. Select either “English”, “Chinese”, or “Russian”.

## Network Camera Control Protocol

### Control Notes:

#### PTZ over TCP/UDP

The camera currently supports various PTZ control methods, including RS232, RS485, IR remote control, web interface, HTTP-CGI and TCP/UDP protocol.

The camera includes an internal TCP server. The default port number is 5678. When client and server set up a TCP connection, the client sends PTZ command to the internal server and the server will then parse and execute the PTZ commands.

The camera includes an internal UDP server. The default port number is 1259. When client and server set up a UDP connection, the client sends PTZ commands to the internal server and the server will then parse and execute the PTZ commands.

**The command format based on VISCA is shown above in the Serial Communication Control Section**

## HTTP-CGI – Control

### Pan and Tilt Control

`http://[Camera IP]/cgi-bin/ptzctrl.cgi?ptzcmd&[Action]&[Pan Speed]&[Tilt Speed]`

**[Action]:** UP, DOWN, LEFT, RIGHT, LEFTUP, RIGHTUP, LEFTDOWN, RIGHTDOWN, PTZSTOP

**[Pan Speed]:** 1 (Slowest) – 24 (Fastest)

**[Tilt Speed]:** 1 (Slowest) – 20 (Fastest)

### Zoom Control

`http://[Camera IP]/cgi-bin/ptzctrl.cgi?ptzcmd&[Action]&[Zoom Speed]`

**[Action]:** ZOOMIN, ZOOMOUT, ZOOMSTOP

**[Zoom Speed]:** 1 (Slowest) – 7 (Fastest)

---

### Focus Control

[http://\[Camera IP\]/cgi-bin/ptzctrl.cgi?ptzcmd&\[Action\]&\[Focus Speed\]](http://[Camera IP]/cgi-bin/ptzctrl.cgi?ptzcmd&[Action]&[Focus Speed])

[Action]: FOCUSIN, FOCUSOUT, FOCUSSTOP

[Focus Speed]: 1 (Slowest) – 7 (Fastest)

### Focus Lock Control

[http://\[Camera IP\]/cgi-bin/param.cgi?ptzcmd&\[Action\]\\_mfocus](http://[Camera IP]/cgi-bin/param.cgi?ptzcmd&[Action]_mfocus)

[Action]: LOCK, UNLOCK

### Preset Control

[http://\[Camera IP\]/cgi-bin/ptzctrl.cgi?ptzcmd&\[Action\]&\[Position Number\]](http://[Camera IP]/cgi-bin/ptzctrl.cgi?ptzcmd&[Action]&[Position Number])

[Action]: POSSET, POSCALL

[Position Number]: 0 – 89 (Range 1), 100 – 254 (Range 2)

### Home Position Recall

[http://\[Camera IP\]/cgi-bin/ptzctrl.cgi?ptzcmd&home](http://[Camera IP]/cgi-bin/ptzctrl.cgi?ptzcmd&home)

### PT Reset

[http://\[Camera IP\]/cgi-bin/param.cgi?pan\\_tiltdrive\\_reset](http://[Camera IP]/cgi-bin/param.cgi?pan_tiltdrive_reset)

### Direct Position Recall Control

[http://\[Camera IP\]/cgi-bin/ptzctrl.cgi?ptzcmd&\[Mode\]&\[Pan Speed\]&\[Tilt Speed\]&\[Pan Position\]&\[Tilt Position\]](http://[Camera IP]/cgi-bin/ptzctrl.cgi?ptzcmd&[Mode]&[Pan Speed]&[Tilt Speed]&[Pan Position]&[Tilt Position])

[Mode]: ABS, REL

[Pan Speed]: 1 (Slowest) – 24 (Fastest)

[Tilt Speed]: 1 (Slowest) – 20 (Fastest)

[Pan Position]: 0001 (First step pan right), 0990 (Last step pan right), FFFE (First step pan left), F670 (Last step pan left)

[Tilt Position]: 0001 (First step tilt up), 0510 (Last step tilt up), FFFE (First step tilt down), FE51 (Last step tilt down)

### Direct Zoom Recall Control

[http://\[Camera IP\]/cgi-bin/ptzctrl.cgi?ptzcmd&zoomto&\[Zoom Speed\]&\[Zoom Position\]](http://[Camera IP]/cgi-bin/ptzctrl.cgi?ptzcmd&zoomto&[Zoom Speed]&[Zoom Position])

[Zoom Speed]: 1 (Slowest) – 7 (Fastest)

[Zoom Position]: 0000 (Full wide), 4000 (Full tele)

## HTTP-CGI – Navigation

### OSD Menu Control

[http://\[Camera IP\]/cgi-bin/param.cgi?navigate\\_mode&\[Mode\]](http://[Camera IP]/cgi-bin/param.cgi?navigate_mode&[Mode])

[Mode]: OSD (OSD Open), PTZ (OSD Close)

### OSD Menu Navigation Control

[http://\[Camera IP\]/cgi-bin/ptzctrl.cgi?ptzcmd&\[Action\]](http://[Camera IP]/cgi-bin/ptzctrl.cgi?ptzcmd&[Action])

[Action]: UP, DOWN, LEFT, RIGHT

---

## OSD Menu Selection Control

[http://\[Camera IP\]/cgi-bin/param.cgi?navigate\\_mode&\[Mode\]](http://[Camera IP]/cgi-bin/param.cgi?navigate_mode&[Mode])

[Mode]: CONFIRM, OSD\_BACK

## HTTP-CGI – Image Adjustment

### Image Settings Control

[http://\[Camera IP\]/cgi-bin/param.cgi?post\\_image\\_value&\[Mode\]&\[Level\]](http://[Camera IP]/cgi-bin/param.cgi?post_image_value&[Mode]&[Level])

[Mode]: BRIGHT, SATURATION, CONTRAST, SHARPNESS, HUE

[Level]: 0 - 14

### Image Orientation Control

[http://\[Camera IP\]/cgi-bin/param.cgi?post\\_image\\_value&\[Mode\]&\[State\]](http://[Camera IP]/cgi-bin/param.cgi?post_image_value&[Mode]&[State])

[Mode]: FLIP, MIRROR

[State]: 1 (Flip / Mirror), 0 (Default)

### Default Image Settings

[http://\[Camera IP\]/cgi-bin/param.cgi?get\\_image\\_default\\_conf](http://[Camera IP]/cgi-bin/param.cgi?get_image_default_conf)

## HTTP-CGI – Inquiries

### Video

[http://\[Camera IP\]/cgi-bin/param.cgi?get\\_media\\_video](http://[Camera IP]/cgi-bin/param.cgi?get_media_video)

Network Video Configuration

### Audio

[http://\[Camera IP\]/cgi-bin/param.cgi?get\\_media\\_audio](http://[Camera IP]/cgi-bin/param.cgi?get_media_audio)

Network Audio Configuration

### Network

[http://\[Camera IP\]/cgi-bin/param.cgi?get\\_network\\_conf](http://[Camera IP]/cgi-bin/param.cgi?get_network_conf)

Network Configuration

### Information

[http://\[Camera IP\]/cgi-bin/param.cgi?get\\_device\\_conf](http://[Camera IP]/cgi-bin/param.cgi?get_device_conf)

Camera Information

### Serial Number

[http://\[Camera IP\]/cgi-bin/param.cgi?get\\_serial\\_number](http://[Camera IP]/cgi-bin/param.cgi?get_serial_number)

Serial Number

*\*Not always accurate*



---

## Photobooth Functionality

Your PTZOptics camera can quickly and easily take a series of four (4) still image or video files that are stored on the camera and made accessible with a standard web browser on the same network.

### Photos

You have two (2) options to initiate a series of four (4) still images being captured...

You can enter the following HTTP string into any web browser on the same network as the camera to initiate a series of four (4) still images.

`http://[Camera IP]/cgi-bin/booth.cgi?0&4&[Delay]&photo&0`

In this example, **[Delay]** is utilized to add additional delay, in seconds, between still images being taken. **[Delay]** can have any value from 1 – 9 seconds.

You can also press the “[F1]” button on your IR remote to initiate a “quick capture” that has, approximately, a four (4) second delay between four (4) still images being captured.

To retrieve your series of four (4) still images, you will need to open a standard web browser with network access to the camera and use the following HTTP strings to retrieve the still image files as desired.

Image 1: `http://[Camera IP]/photo1.jpg`

Image 2: `http://[Camera IP]/photo2.jpg`

Image 3: `http://[Camera IP]/photo3.jpg`

Image 4: `http://[Camera IP]/photo4.jpg`

### Videos

You have two (2) options to initiate a series of four (4) videos being captured...

You can enter the following HTTP string into any web browser on the same network as the camera to initiate a series of four (4) video recordings.

`http://[Camera IP]/cgi-bin/booth.cgi?0&4&[Delay]&video&[Length]`

In this example, **[Delay]** is utilized to add additional delay, in seconds, between videos being taken. **[Delay]** can have any value from 1 – 9 seconds.

In this example, **[Length]** is utilized to adjust the overall length, in seconds, of each video file. **[Length]** can have any value from 1 – 10 seconds.

You can also press the “[F2]” button on your IR remote to initiate a “quick capture” that has, approximately, a four (4)



Share Your Vision

---

second delay between four (4) ten (10) second videos being captured.

To retrieve your series of four (4) videos, you will need to open a standard web browser with network access to the camera and use the following HTTP strings to retrieve the still image files as desired.

Video 1: [http://\[Camera IP\]/video1.mp4](http://[Camera IP]/video1.mp4)

Video 2: [http://\[Camera IP\]/video2.mp4](http://[Camera IP]/video2.mp4)

Video 3: [http://\[Camera IP\]/video3.mp4](http://[Camera IP]/video3.mp4)

Video 4: [http://\[Camera IP\]/video4.mp4](http://[Camera IP]/video4.mp4)

Video note: It can take the camera time for the video files to be fully captured and processed. If they are not retrievable, please wait an additional 30 – 60 seconds for the process to complete.

---

## Maintenance and Troubleshooting

### Camera Maintenance

- If the camera will not be used for a long time, please turn off the power switch.
- Use a soft cloth or lotion-free tissue to clean the camera body.
- Use a soft dry lint-free cloth to clean the lens. If the camera is very dirty, clean it with a diluted neutral detergent. Do not use any type of solvent or harsh detergent, which may damage the surface.

### Unqualified Applications

- Do not shoot extremely bright objects for a long period of time, such as sunlight, ultra-bright light sources, etc...
- Do not operate in unstable lighting conditions, otherwise the image may flicker.
- Do not operate close to powerful electromagnetic radiation, such as TV or radio transmitters, etc...

### Troubleshooting

- No image
  1. Check whether the power cord is connected, voltage is OK, POWER lamp is lit.
  2. Check whether the camera can “self-test” after startup (camera will do a brief pan-tilt tour and return to the home position, or if preset 0 is set, the camera will return to the preset 0 position).
  3. Check that the video cable is connected correctly.
    1. If HDMI, make sure that the destination device is accessing the HDMI port that you plugged into.
    2. If SDI, make sure that the destination device is accessing the SDI port that you plugged into.
- Abnormal display of image
  1. Check setting of rotary dial on rear of camera. Be sure to use a resolution and refresh rate that is supported by your software.
- Image is shaky or vibrating.
  1. Check whether camera is mounted solidly or sitting on a steady horizontal and level surface.
  2. Check the building and any supporting furniture for vibration. Ceiling mounts are often affected by building vibration more than wall mounts.
  3. Any external vibration that is affecting the camera will be more apparent when in tele zoom (zoomed in) settings.

---

## Control

- IR remote controller does not control the camera
  1. Does one of the four (4) “Camera Select” buttons (top row of remote) light up when you press any button on the remote?
    1. If not, change the batteries in the remote.
  2. Are the camera and remote set to the same IR address? When “Display Info” is enabled (within P/T/Z) in the OSD, the camera will display it’s IR address upon start up. Set the IR remote to the same IR address to control the camera.
  3. Try removing other sources of IR interference (e.g. sunlight, fluorescent lighting).
- Serial communication does not control the camera
  1. Make sure the camera is on and functioning with the IR remote control.
  2. Verify that the RS232 cable is connected correctly and using the proper pinout.
  3. Verify the communication settings of the control software or device (e.g. joystick).
  4. Verify that the communication port on the controlling device is activated (e.g. Com port on PC).
  5. Verify that all communication settings in the OSD Setup Menu correlate to the commands being used (e.g. VISCA address).

## Copyright Notice

The entire contents of this manual, whose copyright belongs to PTZOptics, may not be cloned, copied, or translated in any way without the explicit permission of the company. Product specifications and information referred to in this document are for reference only and as such are subject to updating at any time without prior notice.