

PTZOptics Move 4K



User Manual
Model No: PT12X-4K-WH-G3 / PT12X-4K-GY-G3
English



Preface	3
Precautions	3
Warning	3
Warranty	4
Supplied Accessories	4
FCC Statement	4
Copyright Notice	4
NDI@ HX 3 Connection	5
NDI@ HX 3 Setup	5
Features	7
Technical Specifications	8
Dimensions	11
IR Remote Controller Guide	12
Resolution Dial	14
Serial Communication Control	15
RS-232 Interface	15
RS-485 Interface	16
On Screen Display	26
Network Connection	30
Using Auto Tracking	33
Web UI	34
Maintenance and Troubleshooting	58
Camera Maintenance	58
Unqualified Applications	58
Troubleshooting	58

Preface

Congratulations on receiving your new PTZOptics Move 4K Camera. This manual introduces the function, installation, and operation of the HD camera. Prior to installation and usage, please read the manual thoroughly. If you have any questions or issues with this process, please contact our [Support Team](#).

Precautions

This product can only be used in the specified conditions in order to avoid any damage to the unit itself.

- Don't subject the camera to rain or moisture.
- Don't remove the cover. Removal of the cover may result in an electric shock, in addition to voiding the warranty. In case of abnormal operation, contact <https://community.ptzoptics.com/s/>.
- Never operate outside of the specified operating temperature range, humidity, or with any other power supply than the one originally provided with the unit.
- Please use a soft dry cloth to clean the unit. If the unit is very dirty, clean it with diluted neutral detergent; do not use any type of solvents which may damage the surface.

Warning

- Electrical Safety
Installation must be in accordance with national and local electric safety standards. Do not use any power supply other than the one originally supplied with this camera.
- Polarity of Power Supply
The power supply output for this product is 12V DC with a maximum current supply of 2A. Polarity of the power supply plug is critical and is as follows:



- Handling
 - Avoid any stress, vibration, or moisture during transportation, storage, installation, and operation.
 - Do not lift or move the camera by grasping the camera head. Do not turn the camera head by hand. Doing so may result in mechanical damage.
 - Do not expose the camera to any corrosive solid, liquid, or gas to avoid damage to the cover which is made of a plastic material.
 - Ensure that there are no obstacles in the pan or tilt ranges of the camera lens.
 - Never power down the camera on before installation is complete.
- Do not dismantle the camera – PTZOptics is not responsible for any unauthorized modification or dismantling.

Warranty

PTZOptics includes a limited parts & labor warranty for all PTZOptics manufactured cameras. The warranty is valid only if PTZOptics receives proper notice of such defects during the warranty period. PTZOptics, at its option, will repair or replace products that prove to be defective. PTZOptics manufactures its hardware products from parts and components that are new or equivalent to new in accordance with industry standard practices.

Supplied Accessories

When you unpack your camera, check that all the supplied accessories are included:

- | | |
|---------------------|---|
| ▪ Camera | 1 |
| ▪ AC Power Supply | 1 |
| ▪ USB A-A Cable | 1 |
| ▪ RS232 Cable | 1 |
| ▪ IR Remote | 1 |
| ▪ AAA Batteries | 2 |
| ▪ Quick Start Guide | 1 |



FCC Statement

This equipment has been tested and found to comply with the limits for a Class A digital device, pursuant to part 15 of the FCC Rules. These limits are designed to provide reasonable protection against harmful interference when the equipment is operated in a commercial environment. This equipment generates, uses, and can radiate radiofrequency energy and, if not installed and used in accordance with the instruction manual, may cause harmful interference to radio communications. FCC Caution: Any changes or modifications not expressly approved by the party responsible for compliance could void the user's authority to operate this equipment. Operation is subject to the following two conditions: This device may not cause harmful interference, and (2) this device must accept any interference received, including interference that may cause undesired operation.

- **Warning** - This is a class A product. In a domestic environment, this product may cause radio interference in which case the user may be required to take adequate measures.
- **Remote Control Battery Safety Information** - Store batteries in a cool and dry place. Do not throw away used batteries in the trash. Properly dispose of used batteries through specially approved disposal methods. Remove the batteries if they are not in use for long periods of time. Battery leakage and corrosion can damage the remote control. Do not use old batteries with new batteries. Do not mix and use different types of batteries: alkaline, standard (carbon-zinc) or rechargeable (nickel-cadmium). Do not dispose of batteries in a fire. Do not attempt to short-circuit the battery terminals.

Copyright Notice

The entire contents of this manual / guide, whose copyright belongs to PTZOptics, may not be cloned, copied, or translated in any way without the explicit permission of the company. The product specifications referred to in this document are for reference only and as such are subject to updating at any time without prior notice.



NDI®|HX 3 Connection

The NDI®|HX connection allows you to connect and control your camera through any NDI compatible hardware or software on your Local Area Network. Once your camera is setup on a LAN, you can utilize the NDI®|HX connection.

NDI®|HX 3 Setup

1. Download and install the latest NDI®|HX Tools from <https://www.ndi.tv/tools>.
2. Configure your camera settings from the NDI Config tab in the camera's web interface.
3. Select your camera within the NDI®|HX compatible device.
4. Select your camera. The NDI feed will utilize the camera's device friendly name.

NewTek® NDI®, NDI® 4 & NDI®|HX are all registered trademarks by NewTek®. Please note that your NDI License key is non-transferrable.

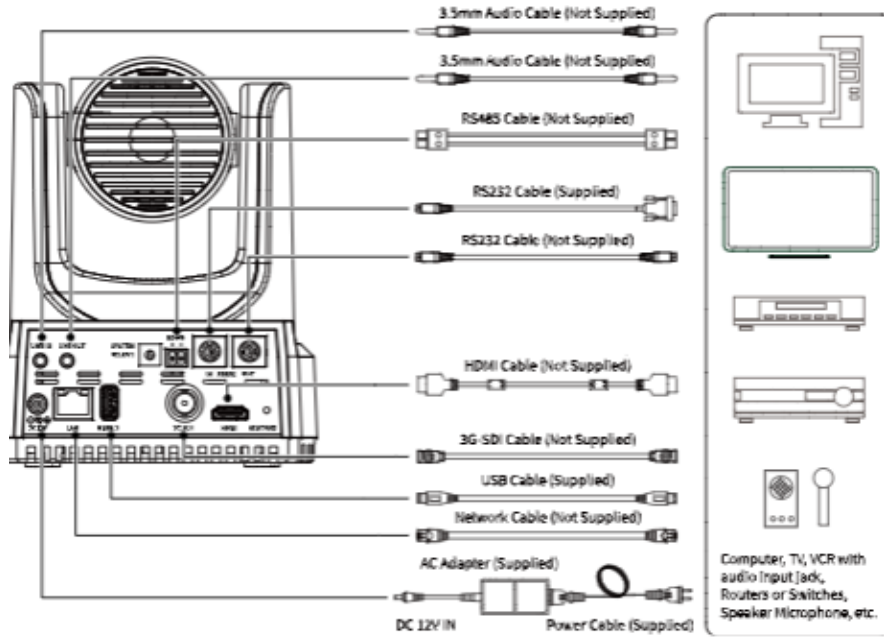

Connection Guide

Please check connections are correct before starting.

Connect the power adapter to the power connector on the rear panel of the camera. The power indicator on the front panel of the camera will be on.

After the camera is powered on, it starts to initialize. It will rotate to the left and right limit positions, and then both horizontal and vertical limit positions. It will then stop at the center position. When the motor stops running, and the initialization is complete.

(Note: If preset 0 is saved, PTZ will be move to preset 0)

Item	Number
1	Line In
2	Line Out
3	Resolution Dial
4	RS485 Interface
5	RS232 IN Interface
6	RS232 OUT Interface
7	DC 12V
8	LAN (PoE+)
9	USB 2.0
10	3G-SDI
11	HDMI
12	Restore*

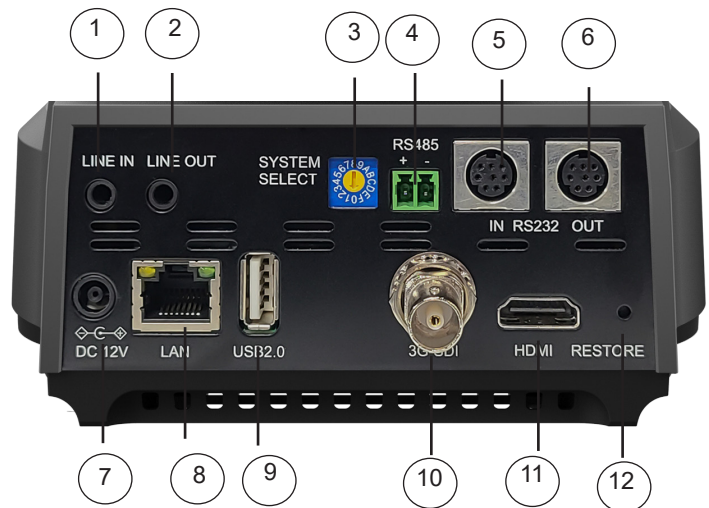

*Restore camera to factory default

Features

- **Built-In Auto-Tracking**
Advanced AI algorithms to enable auto tracking in various scenarios such as education, conferences and live broadcasts.
- **4K 60 fps**
UltraHD 4K (3840x2160p) video resolutions up to 60 FPS.
- **Tally Light**
Features a built-in tally light the light shines GREEN to indicate when the camera is in preview mode. The light shines RED when the camera is on-air. The tally light illuminates when it's being used with NDI-compatible video mixing software.
- **HDMI 2.0**
Supports HDMI 2.0, can directly output 4K uncompressed digital video.
- **Photobooth Functionality**
Save short videos and photos directly to the camera.
- **Low Light**
CMOS image sensor with ultra-high SNR can reduce image noise in low light.
- **3D Noise reduction**
Produces a clean, clear image even in low light and the signal-to-noise ratio is as high as 55dB.
- **Built-in Gravity Sensor**
Supports automatic image flip function, convenient installation and use of engineering.
- **Audio Embedding**
Line-level audio can be embedded over every video output.
- **Multiple Interfaces**
Supports HDMI 2.0 or 3G-SDI, LAN, & USB 2.0.
(HDMI & SDI are not simultaneous.)
- **Remote Control**
Can be controlled through the IR remote, network connection, as well as the RS232, RS485, and the USB port.

Technical Specifications

Model	PT12X-4K-WH-G3 / PT12X-4K-GY-G3
Type	PTZOptics Move 4K
Description	4K60 PTZ camera with auto tracking & HDMI, SDI, USB, & IP, NDI® HX 3 video outputs
Resolution & Frame Rate	HDMI: 2160p-60/59.94/50/30/29.97/25, 1080p-60/59.94/50/30/29.97/25, 1080i-60/59.94/50, 720p-60/59.94
	SDI: 1920x1080p-60/59.94/50/30/29.97/25, 1920x1080i-60/59.94/50, 1280x720p-60/59.94
Sensor	1/2.5 inch, CMOS, Effective pixels: 8.51M
Scanning Mode	Progressive
Lens	f = 4.4mm ~ 52.8mm, F1.8 ~ F2.6
Digital Zoom	Off (3840x2160), 2X (1920x1080), 3X (1280x720), 4X, (960x540), 8X (480x270), 16X (256x144)
Video Based Auto Tracking	Supported
Audio Based Auto Tracking	Not Supported
Minimum Illumination	0.5 Lux @ (F1.8, AGC ON)
Shutter	1/30s ~ 1/10000s
White Balance	Auto, Indoor, Outdoor, One Push, Manual, VAR
Backlight Compensation	Supported
Digital Noise Reduction	3D Digital Noise Reduction
Video Signal Noise Reduction	≥55dB
Horizontal Angle of View	6.9° ~ 72.5°
Horizontal Rotation Range	±170°
Vertical Rotation Range	-30° ~ +90°
Pan Speed Range	1.7° ~ 100°/s
Tilt Speed Range	1.7° ~ 69.9°/s
Image Flip	Supported (built-in gravity sensor)
Image Mirror	Supported
Image Freeze	Supported
PoE+	Supported
Preset Accuracy	0.1°

USB Features	
Operating System	Windows 7 / 8.1 / 10 / 11 / Mac OS, Linux, Android
Color System/Compression	YUY2 / MJPEG / H.264 / H.265
Video Format	YUY2: Max resolution: 3840x2160@5
	H264: Max resolution: 3840x2160@30
	HEVC/H265*: Max resolution: 3840x2160p@30
	MJPEG: Max resolution: 3840x2160p@30
USB Audio	Supported
UVC Version	UVC 1.1 ~ 1.5
UVC Control	Supported
IP Video Features	
Video Compression	H.264, H.265, MJPEG
Video Stream	First Stream, Second Stream
First Stream Resolutions	3840x2160, 1920x1080, 1280x720, 1024x576, 720x480, 720x408, 640x480, 640x360
Second Stream Resolutions	720x480, 720x408, 640x480, 640x360, 480x320, 320x240
Video Bitrate	First Stream: 32kbps ~ 102400kbps
	Second Stream: 32kbps ~ 20480
Bit Rate Type	Constant Bit Rate (CBR), Variable Bit Rate (VBR)
Frame Rate	50Hz: 1 ~ 50 fps
	60Hz: 1 ~ 60 fps
Audio Compression	AAC
Audio Bit Rate	96kbps, 128kbps
Supported Protocols	TCP/IP, UDP, HTTP, RTSP, RTMP/RTMPS, ONVIF, NDI@ HX 3, SRT, Multicast, etc.
Input / Output Interface	
HD Output	1x RJ45: 10/100/1000M Adaptive Ethernet Port
	1x HDMI: version 2.0
	1x USB 2.0: type A
	1x 3G-SDI: BNC type, 800mVP-p, 75Ω, Along to SMPTE 424M standard
Audio Interface	1x 3.5mm Line level Input
	1x 3.5mm Line level Output
Communication Interface	1x 8-pin Mini DIN RS232 Input, Max distance: 98.5ft / 30m, Protocol: VISCA / Pelco-D / Pelco-P
	1x 8-pin Mini DIN RS232 Output, Max distance: 98.5ft / 30m, Protocol: VISCA / Pelco-D / Pelco-P
	1x 2-pin Phoenix port RS485 Input / Output, Max distance: 3,937ft / 1200m, Protocol: VISCA / Pelco-D / Pelco-P
IR	4x IR Addresses, Max distance 30ft / 9m
Power Jack	JEITA type (DC IN 12V)

Physical Parameter	
Input Voltage	DC 12V / PoE+(802.3at)
Current Consumption	Max 2A
Operating Temperature	14°F ~ 104°F (-10°C ~ 40°C)
Storage Temperature	-40°F ~ 140°F (-40°C ~ 60°C)
Humidity Range	10% - 80%
Power Consumption	Max 18W
Size in. (W x D x H)	5.57" W x 5.94" (6.65" including SDI) D x 6.93" (7.91" with tilt up) H
Size mm. (W x D x H)	141.48mm W X169mm (including SDI) D x 176mm (201mm with tilt up) H
Camera Weight	3.25 lbs 1.47kg

* HEVC/H.265 is a registered trademark of Access Advance®, LLC 

Dimensions



6.93 in, (176 mm)



6.65 in (151 mm)

5.57 in (41.48 mm)



IR Remote Controller Guide

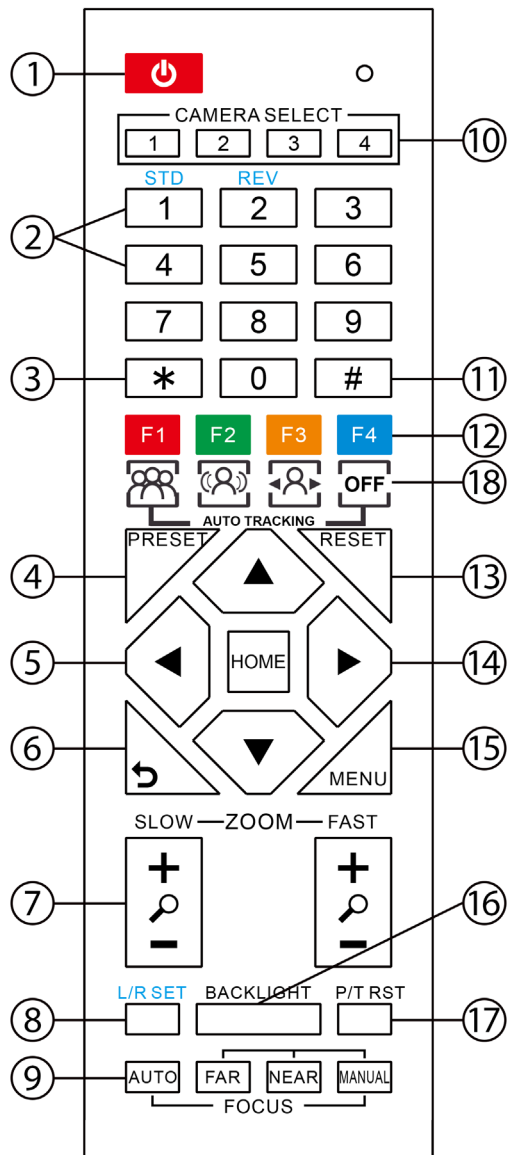

1. Standby Button

Press this button to enter standby mode. Press it again to enter normal mode.
Note: Power consumption in standby mode is approximately half of the normal mode.

2. Position Buttons

To set or call preset position.

3. * Button

For multiple functions. Typically used when calling shortcuts.

4 & 13. Set / Clear Preset Buttons

Set Preset: Store a preset position
 [PRESET] + Numeric button (0-9):
 Setting a corresponding numeric key preset position.

Clear Preset: Erase a preset position.
 [RESET] + Numeric button (0-9) or; [*] + [#] + [RESET]: Erase all presets

5 & 14. Pan / Tilt Control Buttons

Press the arrow buttons to perform panning and tilting. Press the [HOME] button to face the camera back to the front. (PTZ Cameras Only)

6. Return Button

Press the [RETURN] button to go back a previous menu within the OSD menu.

7. Zoom Buttons

Zoom+: Zoom In (Slow and fast speed).
Zoom-: Zoom Out (Slow and fast speed).

8. L / R Set Buttons

Set the Left & Right direction of the remote control.

[L/R SET] + [1]: Normal direction
 [L/R SET] + [2]: Left and right directions will be reversed.

Press buttons simultaneously.

9. Focus Buttons

Used for focus adjustment.

[AUTO]: Automatically focus image on the center object.

[MANUAL]: Allow for manual control of focus. Make adjustments using [FAR] (focus on far object) and [NEAR] (focus on near object).

10. Camera Address Select Buttons

Press the camera select button corresponding to the camera in which you want to operate.

11. # Button

For multiple functions. Typically used when calling shortcuts

12. Multiple Function Buttons

Function 1. For setting camera IR address.

Press 3 keys at the same time to set the camera IR address as follows:

[*] > [#] > [F1]: Address 1

[*] > [#] > [F2]: Address 2

[*] > [#] > [F3]: Address 3

[*] > [#] > [F4]: Address 4

Function 2. Image Freeze function

Press [F4] to enable Image Freeze. After enabled, "Freeze" will be displayed in the upper left corner for 5 seconds.

To disable Image Freeze, press [F4] again.

15. Menu Settings

For adjusting the camera On Screen

Display (OSD) Menu settings

[MENU]: Open or close the On Screen Display menu

16. Backlight Button

Use to enable or disable backlight compensation.

Note: Only effective in auto exposure mode.

Note: If there is light behind the subject, they may appear darker. In this case, use Backlight Compensation to enhance image.

17. P / T RST Button

Perform camera self-calibrate pan and tilt movement. (PTZ Cameras Only)

18. Shortcut Functions

[F1]: Enable video-based auto framing (nonfunctional)

[F2]: Enable audio-based auto tracking (nonfunctional)

[F3]: Enable video-based auto tracking

[F4]: Disable auto tracking

[*] > [#] > [1]: Sets OSD Menu to English

[*] > [#] > [3]: Sets OSD Menu to Chinese

[*] > [#] > [6]: Quickly restore default settings

[*] > [#] > [8]: Show the camera firmware version

[*] > [#] > [4]: Show camera's IP address

[#] > [*] > [F1]: Increase the IR Remote's control speed by 0%

[#] > [*] > [F2]: Increase the IR Remote's control speed by 10%

[#] > [*] > [F3]: Increase the IR Remote's control speed by 20%

[*] > [#] > [MANUAL]: Resets camera IP information

[#] > [*] > [4]: Enables DHCP

[#] > [*] > [#] > [1]: Set IP address to: 192.168.100.81

[#] > [*] > [#] > [2]: Set IP address to: 192.168.100.82

[#] > [*] > [#] > [3]: Set IP address to: 192.168.100.83

[#] > [*] > [#] > [4]: Set IP address to: 192.168.100.84

[#] > [*] > [#] > [5]: Set IP address to: 192.168.100.85

[#] > [*] > [#] > [6]: Set IP address to: 192.168.100.86

[#] > [*] > [#] > [7]: Set IP address to: 192.168.100.87

[#] > [*] > [#] > [8]: Set IP address to: 192.168.100.88

[#] > [*] > [#] > [9]: Set IP address to: 192.168.100.89

[#] > [*] > [#] > [0]: Set IP address to: 192.168.100.80

[*] > [#] > [F1]: Sets camera IR to address 1

[*] > [#] > [F2]: Sets camera IR to address 2

[*] > [#] > [F3]: Sets camera IR to address 3

[*] > [#] > [F4]: Sets camera IR to address 4

- [L/R SET] + [1] (STD): Normal Pan controls
- [L/R SET] + [2] (REV): Reversed Pan controls
- [*] > [#] > [9]: Quickly set mount mode (flip / normal)
- [#] > [*] > [7]: OnePush White Balance Trigger
- [*] > [*] > [F3]: Toggle the HDMI / SDI output
- [#] > [*] > [F4]: Freezes the video feed. Repeat to unfreeze.

- [PRESET] > [0-9]: Sets camera preset
- [RESET] > [0-9]: Erase camera preset
- [*] > [#] > [RESET]: Quickly erase all PTZ presets
- [*] > [#] > [AUTO]: Perform startup dance on repeat

Resolution Dial

Resolution Dial			
HDMI		SDI	
0	1080p 60	0	1080p 60
1	1080p 50	1	1080p 50
2	1080i 60	2	1080i 60
3	1080i 50	3	1080i 50
4	1080p 30	4	1080p 30
5	720p 60	5	720p 60
6	1080p 29.97	6	1080p 29.97
7	1080in 59.94	7	1080i 59.94
8	1080p 29.97	8	1080p 29.97
9	720p 59.94	9	720p 29.97
A	2160p 29.97	A	1080p 29.97
B	2160p 59.94	B	1080p 59.94
C	2160p 25	C	1080p 25
D	2160p 30	D	1080p 30
E	2160p 50	E	1080p 50
F	2160p 60	F	1080p 60

Serial Communication Control

RS-232 Interface

No.	Function
1	DTR
2	DSR
3	TXD
4	GND
5	RXD
6	GND
7	IR OUT
8	NC

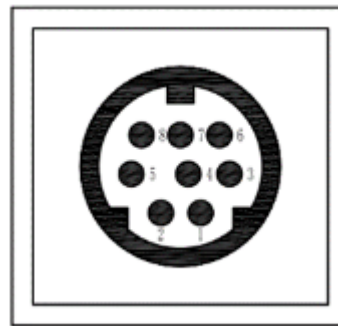

For Initial Connection

Camera	Windows DB-9
1.DTR	1.CD
2.DSR	2.RXD
3.TXD	3.TXD
4.GND	4.DTR
5.RXD	5.GND
6. Unused	6. DSR
7. Unused	7. Unused
8. Unused	8.Unused
9. Unused	9. Unused

For Daisy Chain Control

Camera	Mini DIN
1. DTR	1. DTR
2 DSR	2. DSR
3. TXD	3. TXD
4. GND	4. GND
5. RXD	5. RXD
6. Unused	6. Unused
7. Unused	7. Unused
8.Unused	8. Unused

RS232 Communication Control

This camera can be controlled vis RS-232. The Parameters for RS-232C are as follows:

Baud Rate: 2400, 4800, 9600 or 38400 bps
 Start Bit: 1 bit
 Data Bit: 8 bits
 Stop Bit: 1 bit
 Parity Bit: None

RS-485 Interface

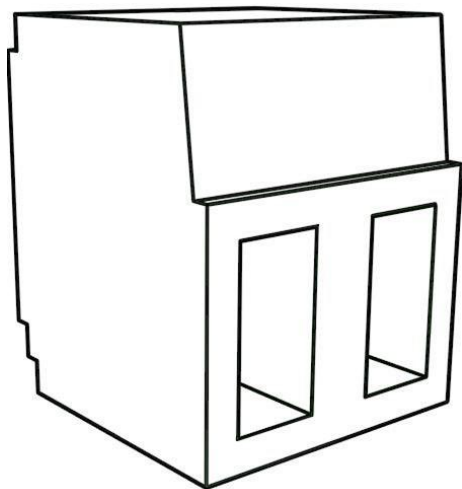

The camera can be controlled via RS-485, Half-duplex mode, with support for VISCA, Pelco-D, or Pelco-P protocol. The parameters of RS485 are as follows:

RS-485 Communication Control

- Baud rate: 2400/4800/9600/38400;
- Starting position: 1 bit
- Data bit: 8 bits
- Stop bit: 1 bit
- Check digit: None

The left phoenix connector port is Positive (+)
The right phoenix connector port is Negative (-)

To utilize an RS-485 connection, you will need an unterminated two conductor cable.

1. Connect the positive (red) wire to the camera's positive phoenix connector port (left).
2. Connect the negative (black) wire to the camera's negative phoenix connector port (right).
3. Connect the positive and negative wires to the positive and negative ports on your joystick controller.
 - o To connect multiple cameras, you have the option to connect via daisy-chain or home run.
4. In either method, multiple wires will be connected to a single phoenix connector port.



RS-485 Daisy-Chain connection

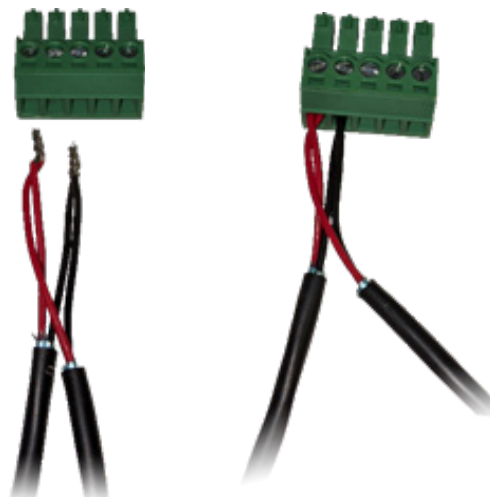

RS-485 Home Run connection

PTZOptics Serial VISCA & VISCA over IP Command List

Part 1: Camera Issued Commands

ACK / Completion Messages			
Command	Function	Command Packet	Comments
ACK / Completion Messages	ACK	z0 4y FF (y: Socket No.)	Returned when the command is accepted.
	Completion	z0 5y FF (y: Socket No.)	Returned when the command has been executed.

Error Messages			
Command	Function	Command Packet	Comments
Error Messages	Syntax Error	z0 60 02 FF	Returned when the command format is different or when a command with illegal command parameters is accepted.
	Command Buffer Full	z0 60 03 FF	Indicates that two sockets are already being used (executing two commands) and the command could not be accepted when received
	Command Canceled	z0 6y 04 FF (y: Socket No.)	Returned when a command which is being executed in a socket specified by the cancel command is canceled. The completion message for the command is not returned.
	No Socket	z0 6y 05 FF (y: Socket No.)	Returned when no command is executed in a socket specified nu the cancel command, or when an invalid Socket No. is specified
	Command Not Executable	z0 6y 41 FF (y: Execution command Socket No. Inquiry command: 0)	Returned when a command cannot be executed due to current conditions. For example: when commands controlling the focus manually are received during auto focus mode.

VISCA over IP control: z = 9
 Serial VISCA control: z = Camera Address + 8

Part 2:PTZOptics Command List

Command	Function	Command Packet	Comments
IF Clear	Broadcast	8x 01 00 01 FF	I/F Clear
CAM_Power	On	8x 01 04 00 02 FF	Power On/Off
	Off	8x 01 04 00 03 FF	
CAM_Zoom	Stop	8x 01 04 07 00 FF	
	Tele (Standard)	8x 01 04 07 02 FF	
	Wide (Standard)	8x 01 04 07 03 FF	
	Tele (Variable)	8x 01 04 07 2p FF	p = 0 (low) – 7 (high)
	Wide (Variable)	8x 01 04 07 3p FF	
	Direct		8x 01 04 47 p q r s FF

CAM_Focus	Stop	8x 01 04 08 00 FF	
	Far (Standard)	8x 01 04 08 02 FF	
	Near (Standard)	8x 01 04 08 03 FF	
	Far (Variable)	8x 01 04 08 2p FF	p = 0 (low) – 7 (high)
	Near (Variable)	8x 01 04 08 3p FF	
	Direct	8x 01 04 48 0p 0q 0r 0s FF	pqrs: Zoom Position (0x04 0x00 0x00 0x00 = Full Zoom in. 0x00 0x00 0x00 0x00 = Full Zoom out.)
	Auto Focus	8x 01 04 38 02 FF	Auto Focus On / Off
	Manual Focus	8x 01 04 38 03 FF	
	Auto / Manual	8x 01 04 38 10 FF	
	Snap Focus	8x 01 04 38 04 FF	Focus image while maintaining manual focus mode.
	Focus Lock	8x 0a 04 68 02 FF	Prevents any other operation or command from adjusting the current focus state.
	Focus Unlock	8x 0a 04 68 03 FF	
CAM_AFSensitivity	High	8x 01 04 58 01 FF	AF Sensitivity High / Normal / Low
	Normal	8x 01 04 58 02 FF	
	Low	8x 01 04 58 03 FF	
CAM_WB	Auto	8x 01 04 35 00 FF	Normal Auto mode
	Indoor	8x 01 04 35 01 FF	Indoor mode
	Outdoor	8x 01 04 35 02 FF	Outdoor mode
	OnePush	8x 01 04 35 03 FF	One Push White Balance mode
	Manual	8x 01 04 35 05 FF	Manual control mode
	ColorTemperature (VAR)	8x 01 04 35 20 FF	Color Temperature mode
	OnePush Trigger	8x 01 04 10 05 FF	One Push White Balance Trigger
CAM_RGain	Reset	8x 01 04 03 00 FF	Default Bright position
	Up	8x 01 04 03 02 FF	
	Down	8x 01 04 03 03 FF	
	Direct	8x 01 04 43 00 00 0p 0q FF	pq: Red Gain
CAM_BGain	Reset	8x 01 04 04 00 FF	Manual control of blue gain
	Up	8x 01 04 04 02 FF	
	Down	8x 01 04 04 03 FF	
	Direct	8x 01 04 44 00 00 0p 0q FF	pq: Blue Gain
CAM_ColorTemp	Reset	8x 01 04 20 00 FF	Default ColorTemperature settings
	Up	8x 01 04 20 02 FF	
	Down	8x 01 04 20 03 FF	
	Direct	8x 01 04 20 0p 0q FF	pq: ColorTemperature position: 0x00: 2500K ~ 0x37: 8000K
CAM_RTuning	Direct	8x 0A 01 12 pq FF	pq: Red / Blue Tuning position 0x00 (-10) ~ 0x14 (+10)
CAM_BTuning	Direct	8x 0A 01 13 pq FF	
CAM_AE	Full Auto	8x 01 04 39 00 FF	Automatic Exposure mode
	Manual	8x 01 04 39 03 FF	Manual exposure mode
	Shutter Priority	8x 01 04 39 0A FF	Shutter priority auto exposure mode
	Iris Priority	8x 01 04 39 0B FF	Iris priority auto exposure mode
	Bright	8x 01 04 39 0D FF	Bright manual exposure mode

CAM_Iris	Reset	8x 01 04 0B 00 FF	Default Iris position
	Up	8x 01 04 0B 02 FF	Iris setting
	Down	8x 01 04 0B 03 FF	
	Direct	8x 01 04 4B 00 00 0p 0q FF	pq: Iris position
CAM_DRC	Direct	8x 01 06 01 0E 0E 03 02 FF	p: 0(low) - 8(high)
CAM_Shutter	Reset	8x 01 04 0A 00 FF	Default shutter position
	Up	8x 01 04 0A 02 FF	Shutter setting
	Down	8x 01 04 0A 03 FF	
	Direct	8x 01 04 4A 00 00 0p 0q FF	pq: Shutter position
CAM_Gain	Reset	8x 01 04 0C 00 FF	Gain Setting
	Up	8x 01 04 0C 02 FF	
	Down	8x 01 04 0C 03 FF	
	Direct	8x 01 04 0C 00 00 0p 0q FF	pq: Gain Position
	Gain Limit	8x 01 04 2C 0p FF	p: Gain Position
CAM_Bright	Reset	8x 01 04 0D 00 FF	Default Bright position
	Up	8x 01 04 0D 02 FF	Bright setting
	Down	8x 01 04 0D 03 FF	
	Direct	8x 01 04 0D 00 00 0p 0q FF	pq: Bright position
CAM_ExpComp	On	8x 01 04 3E 02 FF	Exposure Compensation On / Off
	Off	8x 01 04 3E 03 FF	
	Reset	8x 01 04 0E 00 FF	Default ExpComp position
	Up	8x 01 04 0E 02 FF	ExpComp setting
	Down	8x 01 04 0E 03 FF	
	Direct	8x 01 04 4E 00 00 0p 0q FF	pq: ExpComp position
CAM_NR(2D)Mode	Auto	8x 01 04 50 02 FF	ND2D Auto/Manual
	Manual	8x 01 04 50 03 FF	
CAM_NR(2D)Level	Direct	8x 01 04 53 0p FF	p: NR Setting (0: Off, level 1 to 5)
CAM_NR(3D)Level	Direct	8x 01 04 54 0p FF	p: NR Setting (0: Off, level 1 to 8)
CAM_WDRStrength	Reset	8x 01 04 21 00 FF	
	Up	8x 01 04 21 02 FF	
	Down	8x 01 04 21 03 FF	
	Direct	8x 01 04 51 00 00 0p 0q FF	pq: WDR Level Positon
CAM_Backlight	On	8x 01 04 33 02 FF	Backlight Compensation On / Off
	Off	8x 01 04 33 03 FF	
CAM_Flicker	-	8x 01 04 23 0p FF	p: Flicker settings - (0: Off, 1: 50Hz, 2: 60Hz)
CAM_ApertureMode (Sharpness)	Auto	8x 01 04 05 02 FF	
	Manual	8x 01 04 05 03 FF	
CAM_Aperture (sharpness)	Reset	8x 01 04 02 00 FF	Aperture Control
	Up	8x 01 04 02 02 FF	
	Down	8x 01 04 02 03 FF	
	Direct	8x 01 04 42 00 00 0p 0q FF	pq: Aperture Gain

CAM_Picture Effect	Off	8x 01 04 63 00 FF	Picture Effect setting
	B&W	8x 01 04 63 04 FF	
CAM_Memory	Reset	8x 01 04 3F 00 pp FF	pp: Memory number (=0 to 127)
	Set	8x 01 04 3F 01 pp FF	
	Recall	8x 01 04 3F 02 pp FF	
Preset_Recall_Speed	Preset Speed	8x 01 06 01 p FF	P: Speed grade (0x01 ~ 0x18)
CAM_ImageFreeze	Freeze Image	8x 01 04 62 0p FF	p: 2 ON; p: 3 OFF
CAM_LR_Reverse	On	8x 01 04 61 02 FF	Image Flip Horizontal On / Off
	Off	8x 01 04 61 03 FF	
CAM_PictureFlip	On	8x 01 04 66 02 FF	Image Flip Vertical On / Off
	Off	8x 01 04 66 03 FF	
CAM_ColorGain	Direct	8x 01 04 49 00 00 00 0p FF	P: Color Gain setting 0h (60%) to Eh(200%)
Pan_TiltDrive	Up	8x 01 06 01 VV WW 03 01 FF	VV: Pan Speed 0x01 (low) to 0x18 (high) WW: Tilt Speed 0x01 (low) to 0x14 (high)
	Down	8x 01 06 01 VV WW 03 02 FF	
	Left	8x 01 06 01 VV WW 01 03 FF	
	Right	8x 01 06 01 VV WW 02 03 FF	
	UpLeft	8x 01 06 01 VV WW 01 01 FF	
	UpRight	8x 01 06 01 VV WW 02 01 FF	
	DownLeft	8x 01 06 01 VV WW 01 02 FF	
	DownRight	8x 01 06 01 VV WW 02 02 FF	
	Stop	8x 01 06 01 VV WW 03 03 FF	YYYY: Pan position, ZZZZ: Tilt position
	AbsolutePosition	8x 01 06 02 VV WW 0Y 0Y 0Y 0Y 0Z 0Z 0Z 0Z FF	
	RelativePosition	8x 01 06 03 VV WW 0Y 0Y 0Y 0Y 0Z 0Z 0Z 0Z FF	
	Home	8x 01 06 04 FF	
	Reset	8x 01 06 05 FF	
	Pan_TiltLimitSet	LimitSet	8x 01 06 07 00 0W 0Y 0Y 0Y 0Y 0Z 0Z 0Z 0Z FF
LimitClear		8x 01 06 07 01 0W 07 0F 0F 0F 07 0F 0F 0F FF	
CAM_Brightness	Direct	8x 01 04 A1 00 00 0p 0q FF	pq: Brightness position
CAM_Contrast	Direct	8x 01 04 A2 00 00 0p 0q FF	pq: Contrast position
CAM_Flip	Off	8x 01 04 A4 00 FF	Single Command for video flip
	Flip-H	8x 01 04 A4 01 FF	
	Flip-V	8x 01 04 A4 02 FF	
	Flip-HV	8x 01 04 A4 03 FF	
CAM_SettingSave	Save	8x 01 04 A5 10 FF	Save Current Setting
CAM_AWB Sensitivity	High	8x 01 04 A9 00 FF	
	Normal	8x 01 04 A9 01 FF	
	Low	8x 01 04 A9 02 FF	
CAM_AFZone	Top	8x 01 04 AA 00 FF	AF Zone weight select
	Center	8x 01 04 AA 01 FF	
	Bottom	8x 01 04 AA 02 FF	

CAM_AFZone	Top	8x 01 04 AA 00 FF	AF Zone weight select
	Center	8x 01 04 AA 01 FF	
	Bottom	8x 01 04 AA 02 FF	
CAM_ColorHue	Direct	8x 01 04 4F 00 00 00 0p FF	P: Color Hue setting 0h (-14°) to Eh (+14°)
OSD_Control	Open / Close	8x 01 04 3F 02 5F FF	
	Close	8x 01 06 06 03 FF	
	Navigate Up	8x 01 06 01 0E 0E 03 01 FF	
	Navigate Down	8x 01 06 01 0E 0E 03 02 FF	
	Navigate Left	8x 01 06 01 0E 0E 01 03 FF	
	Navigate Right	8x 01 06 01 0E 0E 02 03 FF	
	Enter	8x 01 06 06 05 FF	
	Return	8x 01 06 06 04 FF	
CAM_LensType	Type1	8x 0A 01 04 1B 00 FF	
	Type 2	8x 0A 01 04 1B 01 FF	
CAM_AFCalibration	Re-Calibrates Focus	8x 0A 01 03 12 FF	Corrects camera focus capabilities
CAM_TallyLight	Tally Light Control	8x 0A 02 02 0p FF	p=1: Flashing, p=2: Light always on, p=3: normal
CAM_NDIMode	High	8x 0B 01 01 FF	
	Medium	8x 0B 01 02 FF	
	Low	8x 0B 01 03 FF	
	Off	8x 0B 01 04 FF	
CAM_Multicast Mode	Multicast Mode	8x 0B 01 23 0p FF	p=1: On, p=2: Off
CAM_PTZMotion Sync	PTZ Motion Sync On	8x 0A 11 13 02 FF	
	PTZ Motion Sync Off	8x 0A 11 13 03 FF	
	PTZ MS Upper Speed Limit	8x 0A 11 14 pq FF	pq: Speed stage
	PTZ MS Lower Speed Limit	8x 0A 11 14 pq FF	
CAM_UACStatus	Toggle USB Audio	8x 2a 02 a0 04 0p FF	p=2: On, p=3: Off
CAM_RTMPSet	Toggle RTMP	8x 0A 11 A8 pq FF	p: 1 Stream 1; p: 2 stream 2; q: 2 ON, q: 3 OFF
CAM_FocusRange	Focus Range	8x 0A 11 42 0p rs tv FF	p=0: Off p=1: On, rs: furthest position(0x00 ~ 0x0B), tv: nearest position(0x00 ~ 0x0B)
CAM_SettingSave	Save	8x 01 04 A5 10 FF	Save Current Setting
CAM_SettingReset	Reset	8x 01 04 A0 10 FF	Reset to Factory Settings
CAM_NetworkReset	Reset Network Parameters	8x 0A 01 AA FF	

VISCA over IP control: x = 1

Serial VISCA control: x = Camera Address + 8

Part 3: PTZOptics Query Command List

CAM_PowerInq	8x 09 04 00 FF	y0 50 02 FF	On
		y0 50 03 FF	Off (Standby)
		y0 50 04 FF	Internal Power Circuit Error
CAM_ZoomPosInq	8x 09 04 47 FF	y0 50 0p 0q 0r 0s FF	pqrs: Zoom position
CAM_FocusAFModelInq	8x 09 04 48 FF	y0 50 02 FF	AutoFocus
		y0 50 03 FF	Manual Focus
CAM_FocusPosInq	8x 09 04 35 FF	y0 50 0p 0q 0r 0s FF	pqrs: Focus Position
CAM_WBModelInq	8x 09 04 35 FF	y0 50 00 FF	Auto
		y0 50 01 FF	Indoor
		y0 50 02 FF	Outdoor
		y0 50 03 FF	OnePush
		y0 50 05 FF	Manual
			ColorTemperature
CAM_RGainInq	8x 09 04 43 FF	y0 50 00 00 0p 0q FF	pq: Red Gain
CAM_BGainInq	8x 09 04 44 FF	y0 50 00 00 0p 0q FF	pq: Blue Gain
CAM_ColorTempInq		y0 50 pq FF	pq: ColorTemperature position
CAM_RTuningInq	8x 09 04 12 FF	90 50 00 00 0p 0q FF	pq: 0x00 ~ 0x14
CAM_BTuningInq	8x 09 04 13 FF	90 50 00 00 0p 0q FF	pq: 0x00 ~ 0x14
CAM_AEModelInq	8x 09 04 39 FF	y0 50 00 FF	Full Auto
		y0 50 03 FF	Manual
		y0 50 0A FF	Shutter Priority (SAE)
		y0 50 0B FF	Iris Priority (AAE)
		y0 50 0D FF	Bright
CAM_ShutterPosInq	8x 09 04 4A FF	y0 50 00 00 0p 0q FF	pq: Shutter position
CAM_IrisPosInq	8x 09 04 4B FF	y0 50 00 00 0p 0q FF	pq: Iris position
CAM_BrightPosInq	8x 09 04 4D FF	y0 50 00 00 0p 0q FF	pq: Bright position
CAM_ExpCompModelInq	8x 09 04 3E FF	y0 50 02 FF	On
		y0 50 03 FF	Off
CAM_ExpCompPosInq	8x 09 04 4E FF	y0 50 00 00 0p 0q FF	pq: ExpComp position
CAM_BacklightModelInq	8x 09 04 33 FF	y0 50 02 FF	On
		y0 50 03 FF	Off
CAM_Noise2DModelInq	8x 09 04 50 FF	y0 50 02 FF	Auto Noise 2D
		y0 50 03 FF	Manual Noise 2D
CAM_Noise2DLevel	8x 09 04 53 FF	y0 50 0p FF	Noise Reduction (2D) p: 0 to 5
CAM_Noise3DLevel	8x 09 04 54 FF	y0 50 0p FF	Noise Reduction (3D) p: 0 to 5
CAM_FlickerModelInq	8x 09 04 55 FF	y0 50 0p FF	p=0: Off, 1: 50Hz, 2: 60Hz
CAM_ApertureModelInq (Sharpness)	8x 09 04 05 FF	y0 50 02 FF	Auto Sharpness
		y0 50 03 FF	Manual Sharpness
SYS_MenuModelInq	8x 09 06 06 FF	y0 50 02 FF	On
		y0 50 03 FF	Off
CAM_PictureEffectModelInq	8x 09 04 63 FF	y0 50 02 FF	Off
		y0 50 04 FF	B&W

CAM_MemoryInq	8x 09 04 3F FF	y0 50 0p FF	p: Memory number last operated
CAM_LR_ReverseInq	8x 09 04 61 FF	y0 50 02 FF	On
		y0 50 03 FF	Off
CAM_PictureFlipInq	8x 09 04 66 FF	y0 50 02 FF	On
		y0 50 03 FF	Off
CAM_ColorGainInq	8x 09 04 49 FF	y0 50 00 00 00 0p FF	P: Color gain 0h (60%) to Eh (200%)
CAM_PanTiltPosInq	8x 09 06 12 FF	y0 50 0w 0w 0w 0w 0z 0z 0z 0z FF	WWWW: Pan position, ZZZZ: Tilt position
CAM_GainLimitInq	8x 09 04 2C FF	y0 50 0q FF	p: Gain limit
CAM_AFSensitivityInq	8x 09 04 58 FF	y0 50 01 FF	High
		y0 50 02 FF	Normal
		y0 50 03 FF	Low
CAM_BrightnessInq	8x 09 04 A1 FF	y0 50 00 00 0p 0q FF	pq: Brightness position
CAM_ContrastInq	8x 09 04 A2 FF	y0 50 00 00 0p 0q FF	pq: Contrast position
CAM_FlipInq	8x 09 04 A4 FF	y0 50 00 FF	Off
		y0 50 01 FF	Flip-H
		y0 50 02 FF	Flip-V
		y0 50 03 FF	Flip-HV
CAM_AFZone	8x 09 04 AA FF	y0 50 00 FF	Top
		y0 50 01 FF	Center
		y0 50 02 FF	Bottom
CAM_ColorHueInq	8x 09 04 4F FF	y0 50 00 00 00 0p FF	P: Color Hue 0h (-14°) to Eh (+14°)
CAM_AWBSensitivityInq	8x 09 04 A9 FF	y0 50 00 FF	High
		y0 50 01 FF	Normal
		y0 50 02 FF	Low
CAM_UACInq	8x 2A 02 A0 04 FF	y0 50 02 FF	On
		y0 50 03 FF	Off
CAM_PTZMotionSyncInq	8x 09 11 13 FF	90 50 0p FF	p: MotionSync setting 0: Off, 1: On
	8x 09 11 14 FF	90 50 pq FF	pq: Max MotionSync speed 00 (185) ~ 09 (230)
CAM_RTMPInq	8x 09 11 53 FF	90 50 00 FF	Stream 1 OFF; Stream 2 OFF
		90 50 01 FF	Stream 1 ON; Stream 2 OFF
		90 50 02 FF	Stream 1 OFF; Stream 2 ON
		90 50 03 FF	Stream 1 ON; Stream 2 ON
VISCA over IP control: x = 1 Serial VISCA control: x = Camera Address + 8			

Block Inquiry Command List			
Command	Command Packet	Inquiry Packet	Comments
CAM_LensBlockInq	8x 09 7E 7E 00 FF	y0 50 0u 0u 0u 0u 00 00 0v 0v 0v 0v 00 0w 00 FF	UUUU: Zoom position VVVV: Focus position W.bit0: Focus mode 1: Auto, 0: manual

CAM_CameraBlocking	8x 09 7E 7E 01 FF	y0 50 0p 0p 0q 0q 0r 0s tt 0u vv ww 00 xx 0z FF	PP: Red Gain, QQ: Blue Gain R: WB Mode, S: Aperture TT: AE Mode, U.bit2: Backlight U.bit1: Exposure Comp, VV: Shutter position. WW: Iris position, XX Bright position, Z: Exposure Comp position
CAM_OtherBlocking	8x 09 7E 7E 02 FF	y0 50 0p 0q 00 0r 00 00 00 00 00 00 00 00 FF	P.bit0: Power 1: On, 0: Off, Q.bit2: LR Reverse: 1: On, 0: Off R.bit3~0: Picture Effect Mode
CAM_EnlargmentBlocking	8x 09 7E 7E 03 FF	y0 50 00 00 00 00 00 00 00 0p 0q rr 0s 0t 0u FF	P: AF sensitivity Q.bit0: Picture flip: 1: On, 0: Off RR.bit6~3: Color Gain (0h (60%) to Eh (200%)) S: Flip 0: Off, 1: Flip-H, 2: FlipV, 3: Flip-HV T.bit2~0: NR2D level U: Gain limit

VISCA over IP control: x = 1

Serial VISCA control: x = Camera Address + 8

VISCA over IP control: y = 9

Serial VISCA control: y = Camera Address + 8

Part 4: Pelco-D Protocol Command List

Function	Byte1	Byte2	Byte3	Byte4	Byte5	Byte6	Byte7
Up	0xFF	Address	0x00	0x08	Pan Speed	Tilt Speed	SUM
Down	0xFF	Address	0x00	0x10	Pan Speed	Tilt Speed	SUM
Left	0xFF	Address	0x00	0x04	Pan Speed	Tilt Speed	SUM
Right	0xFF	Address	0x00	0x02	Pan Speed	Tilt Speed	SUM
Zoom In	0xFF	Address	0x00	0x20	0x00	0x00	SUM
Zoom Out	0xFF	Address	0x00	0x40	0x00	0x00	SUM
Focus Far	0xFF	Address	0x00	0x80	0x00	0x00	SUM
Focus Near	0xFF	Address	0x00	0x00	0x00	0x00	SUM
Set Preset	0xFF	Address	0x00	0x03	0x00	Preset ID	SUM
Clear Preset	0xFF	Address	0x00	0x05	0x00	Preset ID	SUM
Call Preset	0xFF	Address	0x00	0x07	0x00	Preset ID	SUM
Auto Focus	0xFF	Address	0x00	0x2B	0x00	0x01	SUM
Manual Focus	0xFF	Address	0x00	0x2B	0x00	0x02	SUM
Query Pan Position	0xFF	Address	0x00	0x51	0x00	0x00	SUM
Query Pan Position Response	0xFF	Address	0x00	0x59	Value High Byte	Value Low Byte	SUM
Query Tilt Position	0xFF	Address	0x00	0x53	0x00	0x00	SUM
Query Tilt Position Response	0xFF	Address	0x00	0x5B	Value High Byte	Value Low Byte	SUM
Query Zoom Position	0xFF	Address	0x00	0x55	0x00	0x00	SUM
Query Zoom Position Response	0xFF	Address	0x00	0x5D	Value High Byte	Value Low Byte	SUM
Query Zoom Position Response	0xFF	Address	0x00	0x5D	Value High Byte	Value Low Byte	SUM

Part 5: Pelco-P Protocol Command List

Function	Byte1	Byte2	Byte3	Byte4	Byte5	Byte6	Byte7
Up	0xFF	Address	0x00	0x08	Pan Speed	Tilt Speed	SUM
Down	0xFF	Address	0x00	0x10	Pan Speed	Tilt Speed	SUM
Left	0xFF	Address	0x00	0x04	Pan Speed	Tilt Speed	SUM
Right	0xFF	Address	0x00	0x02	Pan Speed	Tilt Speed	SUM
Zoom In	0xFF	Address	0x00	0x20	0x00	0x00	SUM
Zoom Out	0xFF	Address	0x00	0x40	0x00	0x00	SUM
Focus Far	0xFF	Address	0x00	0x80	0x00	0x00	SUM
Focus Near	0xFF	Address	0x00	0x00	0x00	0x00	SUM
Set Preset	0xFF	Address	0x00	0x03	0x00	Preset ID	SUM
Clear Preset	0xFF	Address	0x00	0x05	0x00	Preset ID	SUM
Call Preset	0xFF	Address	0x00	0x07	0x00	Preset ID	SUM
Auto Focus	0xFF	Address	0x00	0x2B	0x00	0x01	SUM
Manual Focus	0xFF	Address	0x00	0x2B	0x00	0x02	SUM
Query Pan Position	0xFF	Address	0x00	0x51	0x00	0x00	SUM
Query Pan Position Response	0xFF	Address	0x00	0x59	Value High Byte	Value Low Byte	SUM
Query Tilt Position	0xFF	Address	0x00	0x53	0x00	0x00	SUM
Query Tilt Position Response	0xFF	Address	0x00	0x5B	Value High Byte	Value Low Byte	SUM
Query Zoom Position	0xFF	Address	0x00	0x55	0x00	0x00	SUM
Query Zoom Position Response	0xFF	Address	0x00	0x5D	Value High Byte	Value Low Byte	SUM

On Screen Display

Main Menu

There are many ways to adjust the camera's On-Screen Display (OSD) Menu. The following instructions will go over the OSD Menu while using the included IR remote.

Press the [Menu] button to display the OSD Menu. Use the arrow buttons to navigate the OSD menu, the [Enter] button to make selections, and the [Return] button to go back a sub menu.

Menu	
Exposure	
Color	
Image	
P / T / Z	
Noise Reduction	
Setup	
Communication Setup	
Restore Defaults	
[Enter] Select	
[Menu] Exit	

(Exposure) Mode: Full Auto, Manual, SAE, AAE, Bright

ExpCompMode: On, Off (Effective only in Full Auto mode).

Exp-Comp: -7 ~ 7 (Effective only when ExpCompMode is On).

Backlight: Toggle Backlight Compensation. Options include: On, Off (Only available in Full Auto mode).

Bright: 0 ~ 17 (Effective only in AAE, Bright mode).

Gain Limit: 0 ~ 15 (Effective only in Full Auto, AAE, Bright mode).

Anti-Flicker: Off, 50Hz, 60Hz (Effective only in Full Auto, AAE, Bright mode).

Iris: F1.8, F2.0, F2.4, F2.8, F3.4, F4.0, F4.8, F5.6, F6.8, F8.0, F9.6, F11.0, Close (Effective only in Manual, AAE mode).

Meter: Average, Canter, Smart, Top. (Available only in Full Auto, SAE, AAE, & Bright)

Shutter: 1/30, 1/40, 1/50, 1/60, 1/70, 1/80, 1/90, 1/100, 1/110, 1/120, 1/130, 1/140, 1/150, 1/160, 1/170, 1/180, 1/190 (Effective only in Manual, SAE mode).

Gain: 0 ~ 7 (Effective only in Manual mode).

DRC: 0 ~ 7

Exposure

Move the cursor to the "Exposure" option and press the [Enter] button to enter the Exposure page, as shown in the figure below.

Exposure	
Mode	Full Auto
Exp-CompMode	Off
Backlight	Off
Gain Limit	10
Anti-Flicker	60Hz
Meter	Average
DRC	1
[Menu] Back	

Color

Move the cursor to the “Color” option and press the [Enter] button to enter the Color page, as shown in the figure below.

Color	
WB Mode	Auto
RG Tuning	0
BG Tuning	0
Saturation	100%
Hue	7
[Menu] Back	

WB Mode: Auto, Indoor, Outdoor, One Push, Manual, VAR

R. Gain: Camera Red Gain value.
Options include: 0 ~ 255
(Only available in Manual modes).

B. Gain: Camera Blue Gain value.
Options include: 0 ~ 255
(Only available in Manual modes).

Color Temp: 2500K ~ 8000K (Effective only in VAR mode).

RG Tuning: -10 ~ +10 (Effective only in Auto, One Push, VAR mode).

BG Tuning: -10 ~ +10 (Effective only in Auto, One Push, VAR mode).

Saturation: Camera Saturation value.
Options include: 0 ~ 14

Hue: Camera Hue value.
Options include: 0 ~ 14

Image

Move the main menu cursor to [Image], and press [HOME] key enter the Image page, as shown in the following figure.

Image	
Luminance	7
Contrast	7
Sharpness	6
Flip-H	Off
Flip-V	Off
B&W-Mode	Off
Style	Default
[Menu] Back	

Luminance: Brightness value.
Options include: 0 ~ 14

Contrast: Contrast value.
Options include: 0 ~ 14

Sharpness: Sharpness value.
Options include: Auto, 0 ~ 11

Flip-H: Flip image horizontally.
Options include: On, Off

Flip-V: Flip image vertically.
Options include: On, Off

B&W Mode: Toggle Black & White mode.
Options include: On, Off

Style: Default, Norm, Bright, PC

P / T / Z

Move the main menu cursor to [Focus], and press [HOME] key enter the Focus page as shown in the following figure:

Focus	
SpeedByZoom	On, Off
AF-Zone	Front
AF Sense	High
L/R Set	Std
Display Info	On
Image Freeze	Off
Digital Zoom	Off
Call Preset Speed	Off
Pre Zoom Speed	5
[Menu] Back	

SpeedByZoom: On, Off

AF Zone: Front, Top, Center, Bottom

AF Sense: High, Normal, Low

L/R Set: STD, REV

Display Info: On, Off

Image Freeze: On, Off

Digital Zoom: On, Off

Call Preset Speed: 1~24

Pre Zoom Speed: 0~7

Noise Reduction

Move the main menu cursor to [Noise Reduction], and press [HOME] key enter the Noise reduction page, as shown in the following figure.

Noise Reduction	
NR3D	6
[Menu] Back	

3D NR: Close, 1 ~ 8.

Setup

Move the main menu cursor to [Setup], and press [HOME] key enter the Setup page, as shown in the following figure.

Setup	
Language	English
Auto Scan Shoot	Off
Auto Focus L	Off
OSD TimeOut	Off
Motion Sync	
Focus Limit	
Video Mode	
Other	
[Menu] Back	

Language: Options include: English, Chinese, Russian, French, Spanish, Italian and German,

Auto Scan Shoot: Call each of the camera's pre sets sequentially.

Options include: Off, On

Auto Focus L: Lock the focus in the current position.

Options include: Off, On

OSD TimeOut: Auto close OSD Menu.

Options include: Off, 2.5min

Motion Sync: Synchronize pan, tilt, and zoom to arrive at the preset simultaneously.

Options include: Off, On (Can be reached by entering the Setup > Motion Sync).

- Max Speed: The maximum speed Motion Sync will use when calling presets.

Options include: 185 ~ 230 (increments of 5)

Focus Limit: Define a range the camera can focus within.

Options include: Off, On (Can be reached by entering Setup > Focus Limit).

- Furthest Pos: Define the farthest focus position. Options include: INF, 1m ~ 20m

- Nearest Pos: Define the nearest focus position. Options include: INF, 1m ~ 20m

Video Mode: Configure assorted video output settings.

- **SDI-3G Mode:** Set the SDI level.
Options include: Level-A, Level-B
- **Video Output:** Set the video output to SDI or HDMI.
Options include: HDMI, SDI
- **DVI Mode:** define HDMI Data Transfer type.
Options include: HDMI, DVI

Other:

- **Auto Inversion:** Toggle auto inversion.
Options include: Off, On
- **Tally Mode:** Toggle the tally light functionality. Options include: Off, On
- **USB Audio:** Toggle USB audio embedding.
Options include: Off, On
- **USB2.0 Function:** Define how the USB port is used. Options include: UVC, Host

Communication Setup

Move the main menu cursor to [Communication Setup] and press [HOME] key enter Communication Setup page, as shown in the following figure.

Communication Setup	
Protocol	VISCA
V_Address	1
V-AddrFix	Off
Net Mode	Serial
Baudrate	9600
[Menu] Back	

Protocol: Control protocol
Options include: VISCA, PELCO-D, PELCO-P, Auto

V_Address: VISCA protocol camera address
Options include: 1 ~ 7

V-AddrFix: When enabled, the Visca address will not change. Options include: Off, On

Net Mode: Control type
Options include: Serial, Paral

Baudrate: Baudrate control speed
Options include: 2400, 4800, 9600, 38400

P_D_Address: Pelco-D protocol address
Options include: 0 ~ 254

P_P_Address: Pelco-P protocol address
Options include: 0 ~ 31

Restore Default

Move the cursor to the “Restore Default” option and press the [Enter] button to enter the Restore Default page, as shown in the figure below.

Restore Default	
Press [Enter]	Confirm
Press [Back]	Cancel
Select [Enter]	
[Menu] Back	

Note: Press the [Enter] button to confirm. All camera parameters will return to default, including IR remote & VISCA Addresses.

Network Connection

Operating Environment

- Operating System: Windows 7 / 8.1 / 10 / 11, Mac OS X, Linux, Android
- Network Protocol: TCP/IP
- Client PC: P4 / 128M RAM / 40G HDD / supported scaled graphics card, support for DirectX 8.0+.

Equipment Installation

1. Connect the camera to your network via a CAT5 or CAT6 cable directly to your network switch.
2. Turn on power.
3. If successful, the orange network light will illuminate and the green light will start flashing.

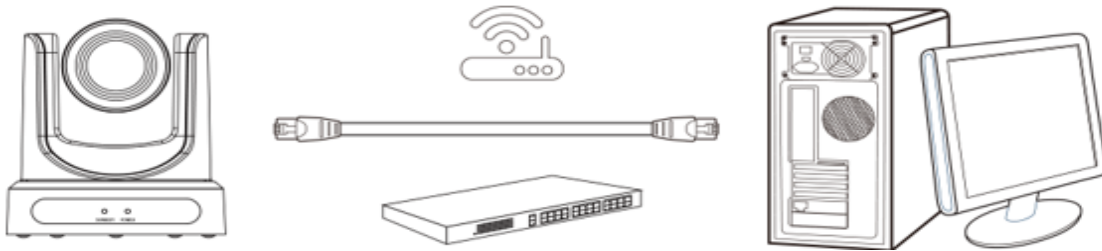

Picture 1.2 Connections to LAN via patch cable to LAN wall jack or LAN Switch

Finding the camera's IP Address

The camera will automatically acquire an IP address when connected to the network. If the network cannot assign an IP address, the camera will default to "192.168.100.88". If you don't know the camera IP, please do one of the following:

- Method 1: Use a Internet browser and type in "http://ptzoptics.local/" to reach the camera's web interface. From there, the Network Settings page will allow you to view the camera's network settings.
- Method 2: Use the IR remote shortcut [*] > [#] > [4] to display the camera's IP address.

Once you find the camera you wish to adjust, right click the corresponding IP address to reveal the control menu. From here, select the corresponding tab for the way you want to adjust your camera.

Discovering your Network Info

To discover your IP address range/scheme, Subnet Mask, Gateway, & First DNS, follow the instructions below for Windows or Mac OS. You may need to talk with your IT department to obtain this information.

Windows

1. Open the Start menu and type "CMD" into the search bar.
2. Once the Command Prompt is open, type in "ipconfig" and press the Enter key.
3. Scroll down to the section titled "Ethernet adapter Ethernet" or "Ethernet adapter Wireless Network Connection".
4. Locate the "IPv4 Address" in that section. This is your computers local IP address.
5. In the example above, the PC's local address is "192.168.15.117", making the network range "192.168.15".

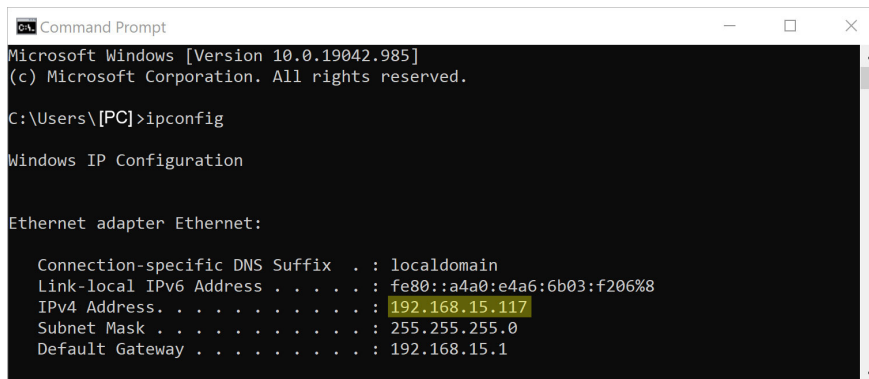

```
Command Prompt
Microsoft Windows [Version 10.0.19042.985]
(c) Microsoft Corporation. All rights reserved.

C:\Users\PC>ipconfig

Windows IP Configuration

Ethernet adapter Ethernet:

    Connection-specific DNS Suffix . . . : localdomain
    Link-local IPv6 Address . . . . . : fe80:a4a0:e4a6:6b03:f206%8
    IPv4 Address. . . . . : 192.168.15.117
    Subnet Mask . . . . . : 255.255.255.0
    Default Gateway . . . . . : 192.168.15.1
```

Mac

1. Open a new *Finder* window and go to the *Applications* folder.
2. Open the *Utilities* folder and select the *Terminal* program.
3. Once the *Terminal* program is open, type in “`ipconfig getifaddr en0`” and press the Enter key.

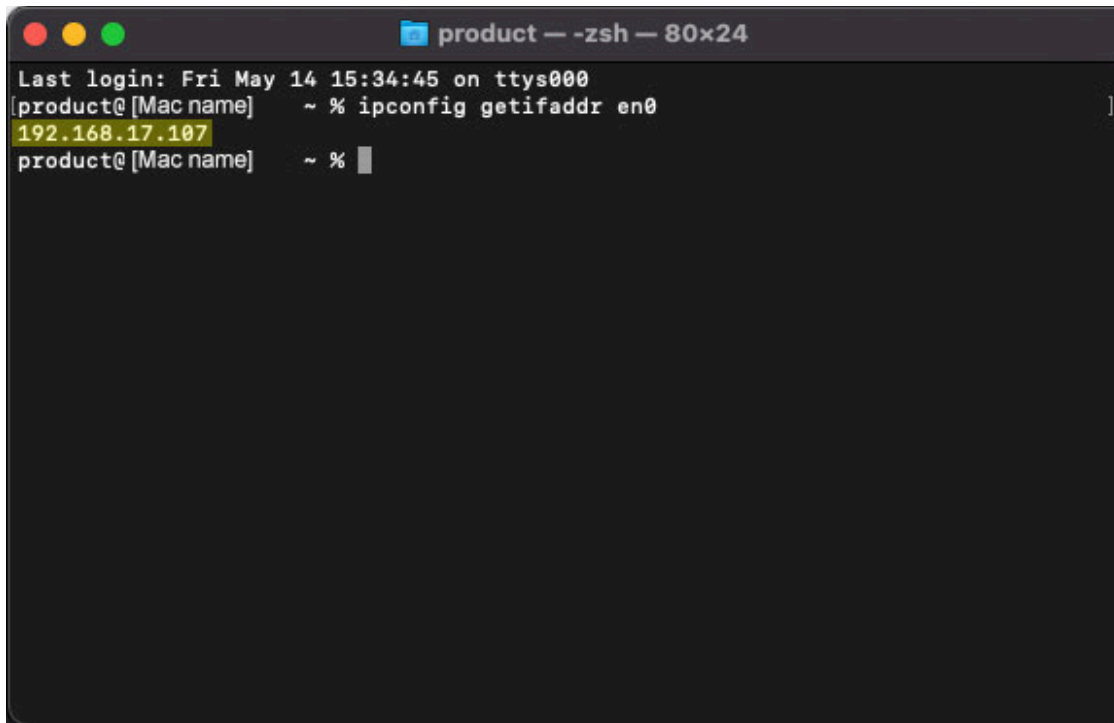

```
product — zsh — 80x24
Last login: Fri May 14 15:34:45 on ttys000
[product@[Mac name] ~ % ipconfig getifaddr en0
192.168.17.107
product@[Mac name] ~ %
```

4. In the example above, the Mac’s local address is “192.168.17.107”, making the network range “192.168.17”.

Using Auto Tracking

- The PTZ Optics Move 4K Cameras feature built-in auto-tracking capabilities. You can turn on Auto-Tracking by pressing the auto-track button on the IR remote control (F3) or via the web-interface, as shown below.
- Include a screenshot of the camera's Web UI of the Control > Modes section.
- The Move 4K's auto-tracking can lock into a specific person, even while other people are in frame. Once tracking is enabled, a green box will appear around a subject. You can change between subjects using the left and right arrows on the IR remote controller. Once the desired subject has been found, press the Home button on the IR remote to confirm your selection. A red box will appear temporarily, displaying a target has been confirmed.
- Auto Tracking Distance Limitations: (include the table below)

Camera Model	Auto-Tracking Distance Limitation
12X Move 4K	200 feet (60 Meters)
20X Move 4K	250 feet (76 Meters)
30X Move 4K	300 feet (91 Meters)

Web UI

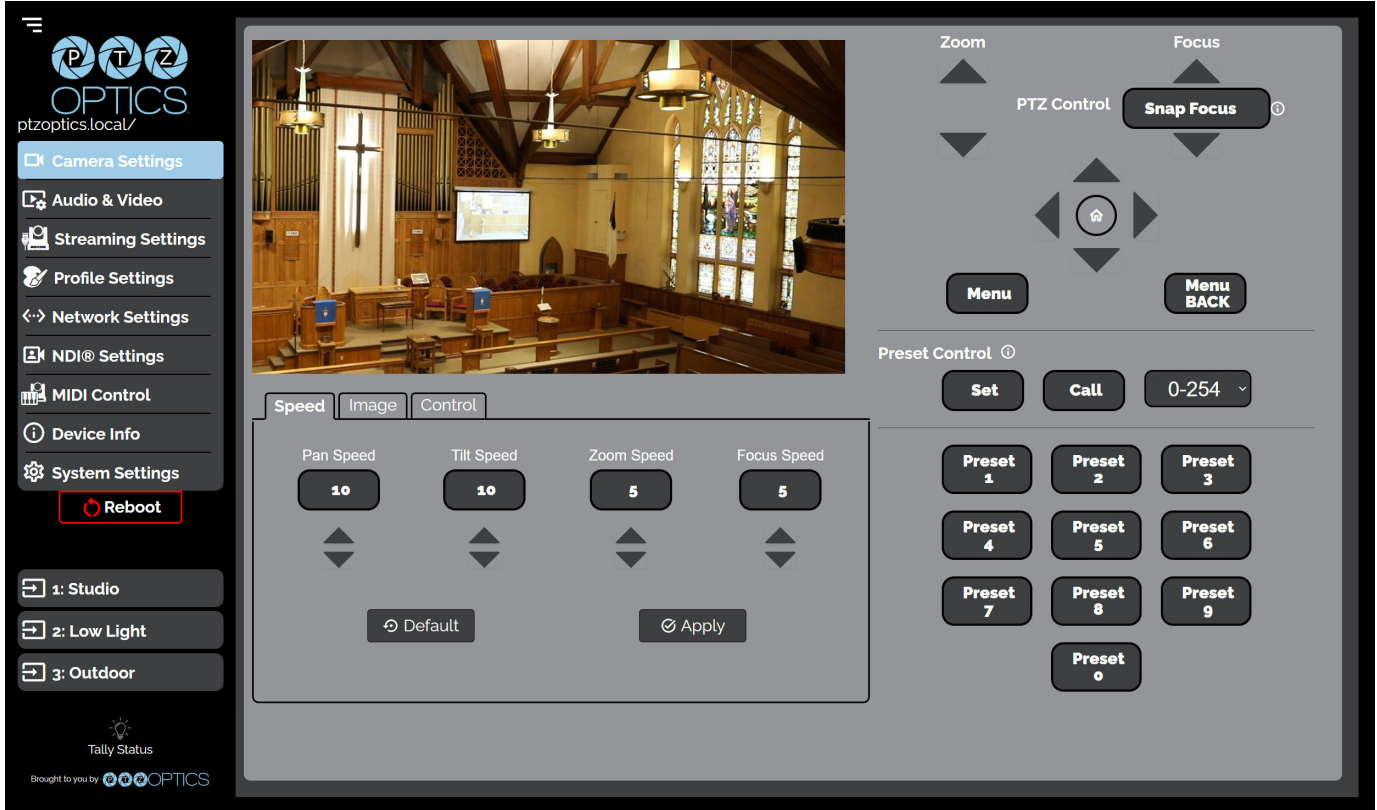

Access Camera

1. Enter “<http://ptzoptics.local/>” or the camera’s IP address into a web browser.
2. Enter the username and password into the login fields. Both the username and password are “admin” by default. You can change the login credentials on the [System Settings](#) page.



Navigation Panel

The **Navigation Panel** allows you to quickly and easily select the various control options for the camera. It can be collapsed for more room on the user interface.

You can load preconfigured Profiles to the camera by selecting the desired Profile from the Navigation Panel.

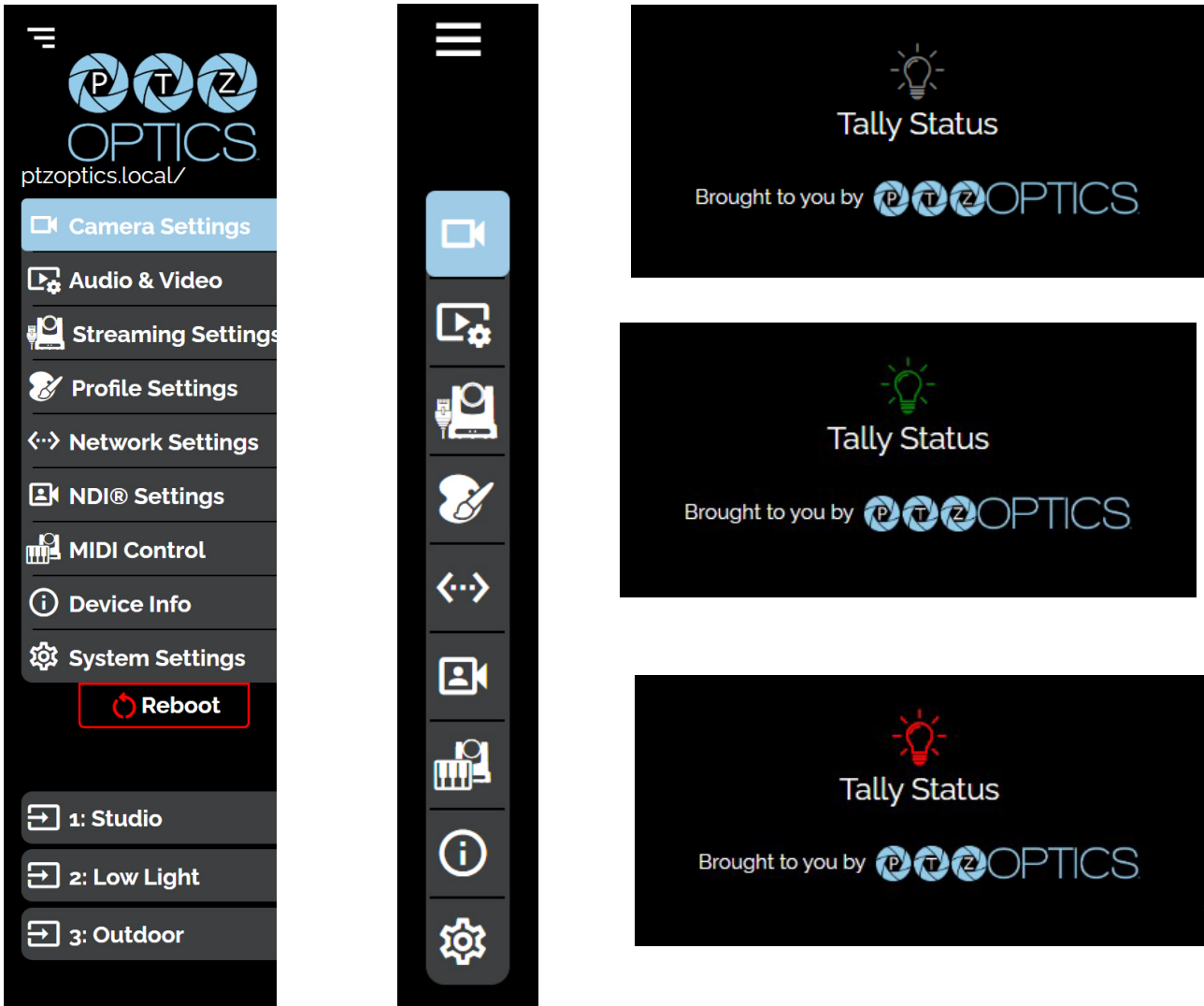

- **Logo:** You can change the photo in the Navigation Panel using Logo Upload from the [Profile Settings](#) page.
- **Camera Name:** You can change the camera's name from the [Device Info](#) page. The “.local/” appendage will always be on the end to give an easy remind on how to return to this Web UI.
- **Reboot Button:** The Reboot button will reboot your camera. It can be easily accessed from any page while the Navigation Panel is maximized.
- **Quick Profile:** You quickly can change between pre-configured camera settings using the Profiles saved to the Navigation Panel.
- **Tally Status:** The Tally Status icon will mirror the tally light built into the camera as an easy reminder for when the camera is in Preview (green) or Program (red). This can be toggled on and off on the [Camera Settings](#) page.

Camera Settings

The **Camera Settings** page gives you access to the **Camera’s Video Feed, PTZ Control, OSD Menu, Preset Control, Speed Settings, Image Settings & Control Settings.**

All of the settings available in the Image tab are also available in the camera’s menu. The settings are offered in the Web UI so you don’t have to open the Menu while the camera is in use.

- The PTZ Control section allows you to Pan, Tilt, Zoom, and Focus the camera.
- The Menu and Menu Back buttons allow you to navigate the Menu when needed.
- The Preset Control section allows you to save and call up to 255 presets.
 - The Preset 0 – 9 buttons allow you to quickly call the first 10 presets..

Speed

The **Speed** tab within Camera Settings page allows you to adjust the speed at which the camera will **Pan, Tilt, Zoom, and Focus** while in the Web UI.

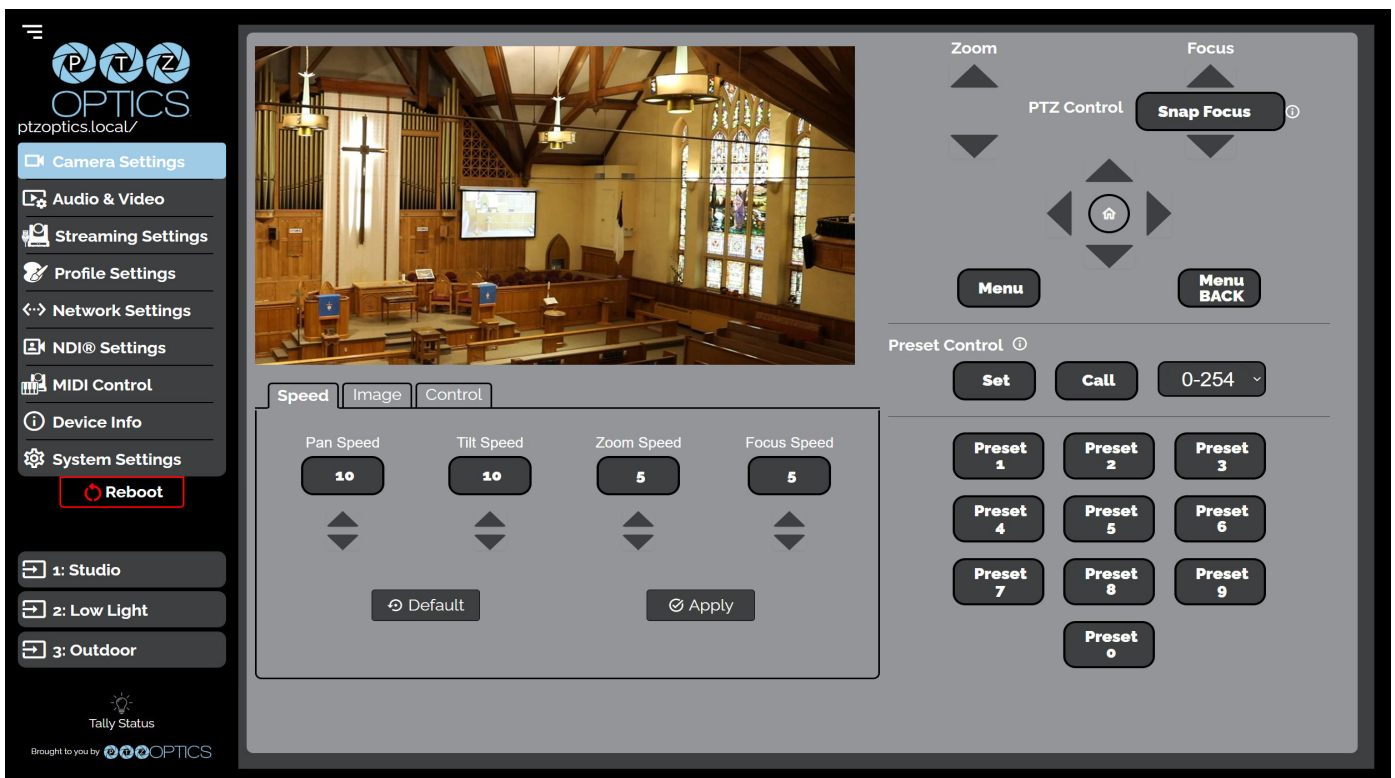

- You must click the “Apply” button to save the current Speed settings to the camera.
- The “Default” button will revert the Speed settings to factory default, as shown in the image above

Image

The **Image > Image** tab within the Camera Settings page allows you to adjust the camera's **Luminance, Saturation, Contrast, Sharpness, Hue, 3D Noise Reduction, Inversion Mode & Black and White Mode.**

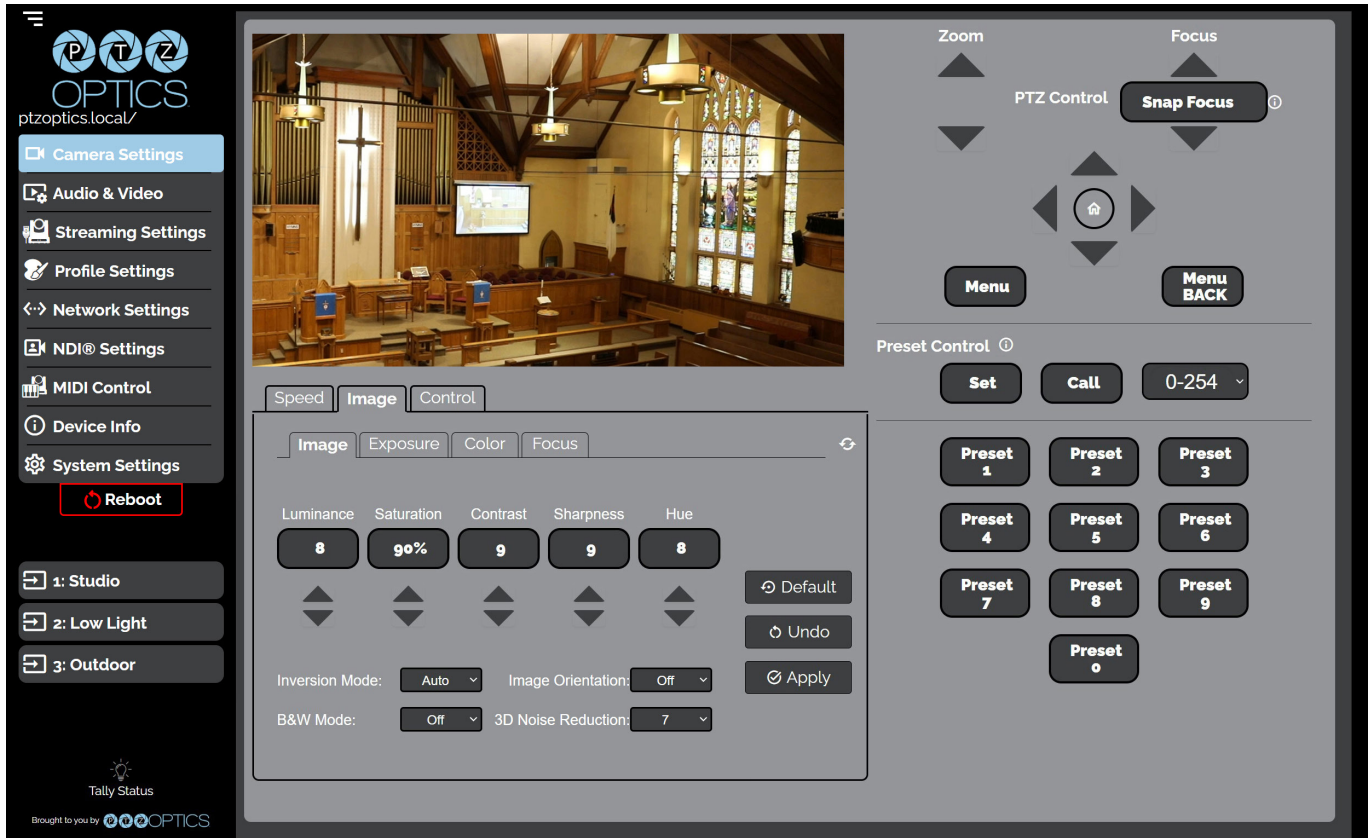

- You must hit the “Apply” button for these changes to take effect.
- The “Default” button will revert the Image settings to factory default.
- The “Undo” button will revert the Image settings to the last saves settings.

Exposure

The **Image > Exposure** tab within the Camera Settings page allows you to fine tune the camera's Exposure settings to ensure image clarity as well as ensuring the images from multiple cameras match.



- You must click the “Apply” button to save the Exposure settings to the camera.
- The “Default” button will revert the Exposure settings to factory default, as shown in the image above.

Color

The **Image > Color** tab within the Camera Settings page allows you to fine tune the camera's white balance and color tint settings to adjust for lighting, as well as ensuring images from multiple cameras match.



- You must click the “Apply” button to save the Color settings to the camera.
- The “Default” button will revert the Color settings to factory default, as shown in the image above.

Focus

The **Image > Focus** tab within the Camera Settings page allows you to adjust the various focus settings, including **Auto Focus**, **Auto Focus Zone**, **Auto Focus Sensitivity**, **Focus Lock** and **Focus Limit**.



- You must click the “Apply” button to save the Focus settings to the camera.
- The “Default” button will revert the Focus settings to factory default, as shown in the image above.

Control Mode

The **Control > Mode** tab within the Camera Settings page allows you to toggle available camera modes, such as **Auto Tracking**, **Tracking Box**, **Patrol Mode**, **Preset Freeze**, **Zoom Mode**, **Motion Sync & Tally Mode**.



- **Auto Tracking:** Select whether the camera automatically tracks the selected target
 - Options include: On, Off
- **Tracking Box:** Select if/how the Tracking Box is shown around the selected target on the video feed.
 - Options include: Off, Debug, & Select Target
- **Patrol Mode:** When enabled, the camera will call each of the Set presets sequentially.
 - Options include: On, Off
- **Preset Freeze:** When enabled, the video feed will temporarily pause while Calling a preset.
 - Options include: On, Off
- **Zoom Mode:** Select whether the camera utilizes Digital Zoom or not.
 - Options include: Optical, Digital, Hybrid (Enabled on the Audio & Video page)
- **Magnification:** (Only available when “Digital” is selected from Zoom Mode) Define the Digital Zoom limit.
 - Options include: 2x, 4x, 8x, & 16x
- **Motion Sync:** When enabled, the camera will adjust Pan, Tilt, and Zoom speeds so that all 3 axis stop simultaneously.
 - Options include: On, Off
- **Tally Mode:** When enabled, the Web Interface’s Tally Status icon at the bottom of the Navigation Panel will reflect the Tally Light on the front of the camera.
 - Options include: On, Off
- You must click the “Apply” button to save the Mode to the camera.
- The “Cancel” button will revert the Mode settings to the last saved settings.

Control Ports

The **Control > Ports** within the Camera Settings page allows you to change the camera's **TCP**, **UDP**, & **HTTP** control ports. The **Sony UDP** Port can not be changed.



- You must click the “Apply” button to save the Ports to the camera.
- The “Cancel” button will revert the Ports settings to the last saved settings.

Audio Video Settings

The **Audio & Video Settings** page accesses the **Video Encoding Settings**, **IP Video Stream 1 / Stream 2 Encoding Settings** & **Audio Encoding Settings** sections of the network video feeds.

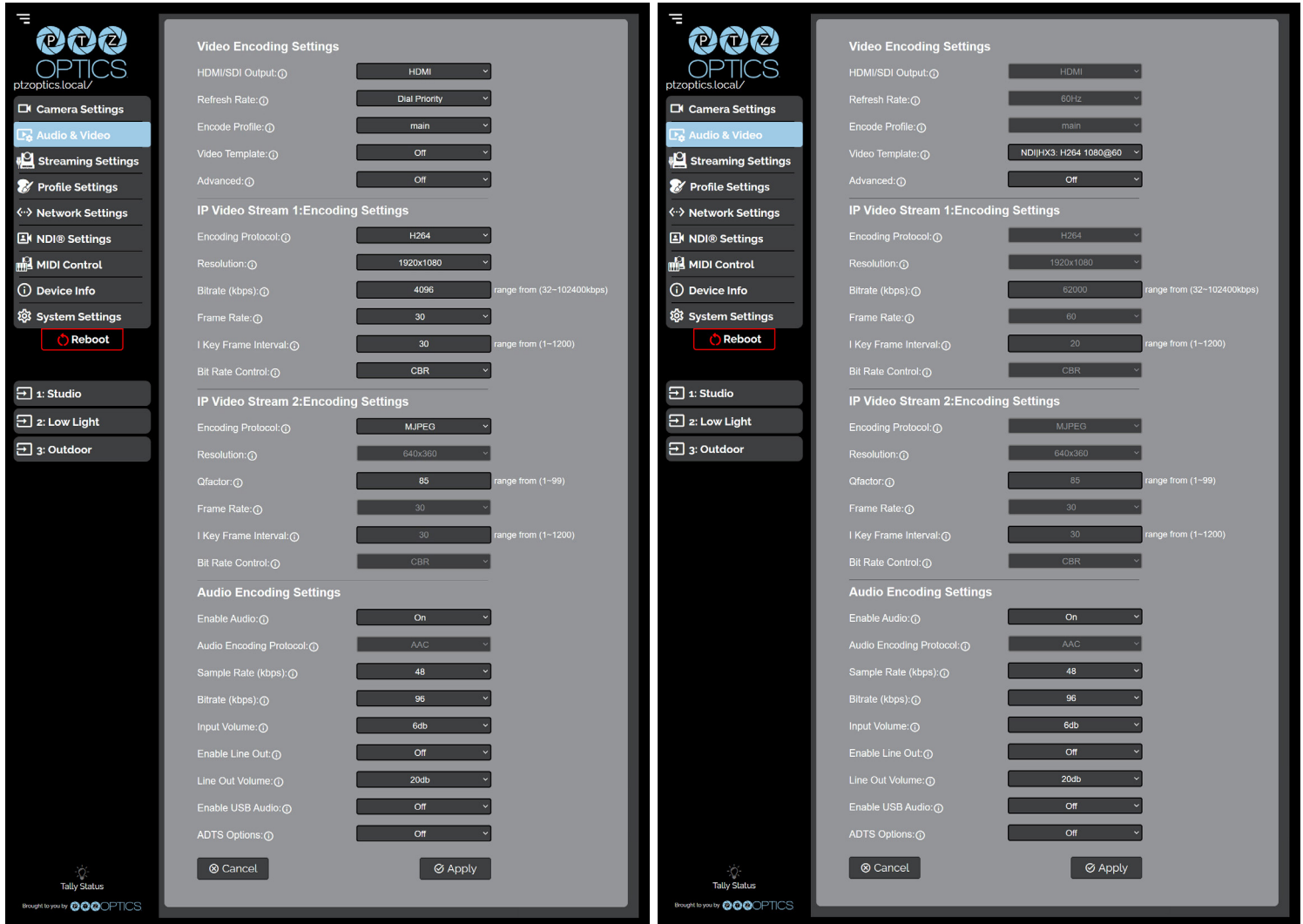

- **Video Encoding Settings**

- **HDMI/SDI Output:** Set either HDMI or SDI to output video (not simultaneous).
 - Options include: HDMI, SDI
- **Refresh Rate:** Frequency adjustment for displays. Select the refresh rate for your region.
 - Options include: Dial Priority, 50Hz, 60Hz
- **Encode Protocol:** The Encoding Profile defines the compression method and color reproduction of the IP Stream.
 - Options include: Main, High
- **Video Template:** Select from frequently used pre-configured settings. You can manually define the non NDI |HX3 settings.
 - Options include: Ultra, High, Medium, Low, NDI |HX3 H264 1080@ 50, NDI |HX3 H264 1080@ 60, NDI |HX3 H265 1080@ 50, NDI |HX3 H265 1080@ 60

- When any of the NDI |HX3 templates are selected, the Hard Output, Refresh Rate, Encoding Profile, Encoding Protocol, Resolution, Bitrate, Frame Rate, I Key Frame Interval, & Bit Rate Control settings are all locked.
 - **Advanced:** Hybrid Zoom decreases the output resolution to increase the maximum zoom level.
 - Options include: Off, Hybrid Zoom
- **IP Video Stream 1 & 2: Encoding Settings**
 - **Encoding Protocol:** Define the compression method for the stream.
 - Options include: H264, H265, MJPEG
 - **Resolution:** Define the resolution of the stream.
 - Stream 1 options include: 3840x2160, 1920x1080, 1280x720, 1024x576, 720x480, 720x408, 640x480, 640x360
 - Stream 2 option includes: 720x480, 720x408, 640x480, 640x360, 480x320, & 320x240
 - **Bitrate (kbps):** Define the bit rate of the stream in kilobits. The higher the value, the higher the video quality at the cost of higher bandwidth.
 - Stream 1 Range: 1 ~ 102400
 - Stream 2 Range: 1 ~ 20480
 - **QFactor:** Define the Quality Factor of the stream. The higher the value, the higher the video quality at the cost of higher bandwidth (Only available when MJPEG is selected as the Encoding Protocol).
 - Range: 1 ~ 99
 - **Frame Rate:** Define the Frame Rate of the stream.
 - Range: 1 ~ 60
 - **I Key Frame Interval:** Define the I-Key Frame Interval of the stream.
 - Options include: 1 ~ 1200
 - **Bit Rate Control:** Select whether the Bit Rate fluctuates (VBR) or is static (CBR).
 - Options include: CBR, VBR
- **Audio Encoding Settings**
 - **Enable Audio:** Select whether Audio is included on the applicable video outputs.
 - Options include: On, Off
 - **Sample Rate (kbps):** Define the amount of samples per second the audio utilizes.
 - Options include: 44.1, 48
 - **Bitrate (kbps):** Define the amount of bits per second the audio utilizes in kilobits
 - Options include: 96, 128
 - **Input Volume:** Define the Input Volume of the Audio Input.
 - Range: 0db ~ 59db
 - **Enable Line Out:** Toggle the Line Output port on or off.
 - Options include: On, Off
 - **Line Out Volume:** Define the Output Volume of the Audio Output
 - Range: 0db ~ 59db
 - **Enable USB Audio:** Define whether the USB video out includes audio.
 - Options include: On, Off
 - **ADTS Options:** Select whether Audio Data includes timestamps.
 - Options include: On, Off

Streaming Settings

The **Streaming Settings** page accesses the **RTMP(S) Settings**, **SRT Settings**, **RTSP Settings**, **Multicast Settings** & **ONVIF Settings** sections.

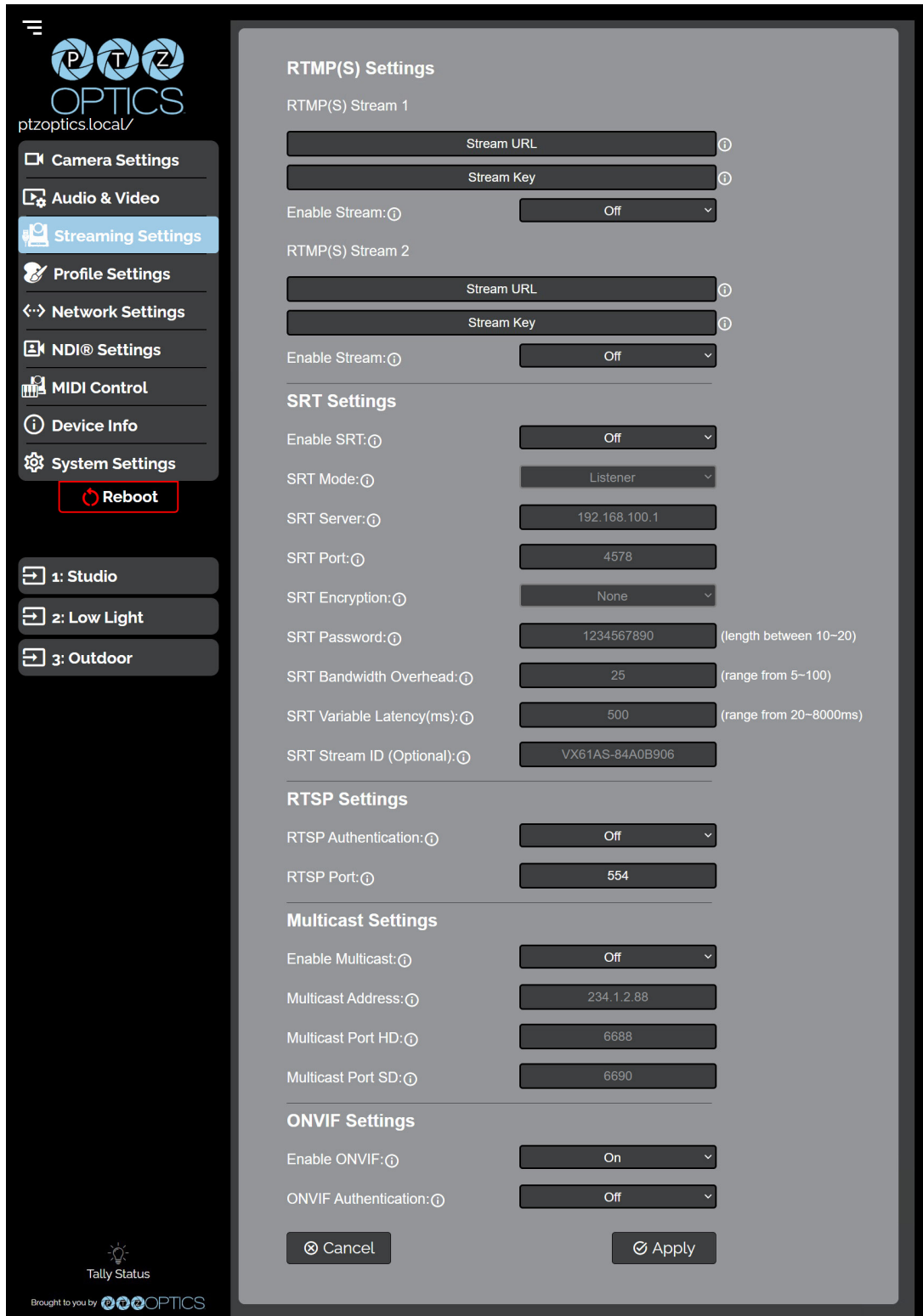

The screenshot shows the PTZ OPTICS web interface. On the left is a navigation sidebar with the following menu items: Camera Settings, Audio & Video, Streaming Settings (highlighted), Profile Settings, Network Settings, NDI® Settings, MIDI Control, Device Info, and System Settings. Below the menu is a red 'Reboot' button and three scene buttons: 1: Studio, 2: Low Light, and 3: Outdoor. The main content area is titled 'Streaming Settings' and contains several sections:

- RTMP(S) Settings:**
 - RTMP(S) Stream 1:** Stream URL, Stream Key, and Enable Stream (set to Off).
 - RTMP(S) Stream 2:** Stream URL, Stream Key, and Enable Stream (set to Off).
- SRT Settings:**
 - Enable SRT: Off
 - SRT Mode: Listener
 - SRT Server: 192.168.100.1
 - SRT Port: 4578
 - SRT Encryption: None
 - SRT Password: 1234567890 (length between 10–20)
 - SRT Bandwidth Overhead: 25 (range from 5–100)
 - SRT Variable Latency(ms): 500 (range from 20–8000ms)
 - SRT Stream ID (Optional): VX61AS-84A0B906
- RTSP Settings:**
 - RTSP Authentication: Off
 - RTSP Port: 554
- Multicast Settings:**
 - Enable Multicast: Off
 - Multicast Address: 234.1.2.88
 - Multicast Port HD: 6688
 - Multicast Port SD: 6690
- ONVIF Settings:**
 - Enable ONVIF: On
 - ONVIF Authentication: Off

At the bottom of the settings area are 'Cancel' and 'Apply' buttons. The footer of the interface includes a 'Tally Status' indicator and the text 'Brought to you by PTZ OPTICS'.

- **RTMP(S) Stream 1 & 2 Settings**
 - **RTMP(S) Stream URL:** Define the RTMP Address of the CDN you wish to stream to.
 - **RTMP(S) Stream Key:** Define the stream key of the CDN you wish to stream to.
 - **Enable Stream:** Toggle the RTMP stream on or off.
- **SRT Settings**
 - **SRT:** Toggle the SRT stream on or off.
 - **SRT Mode:** Define whether the SRT stream is pulled (Listener) from the camera, or whether the stream must be pushed (Caller) to a server.
 - **SRT Server:** Define the Server IP address. This is only used in Caller mode.
 - **SRT Port:** The SRT Port is how you reach the SRT video feed of your camera.
 - **SRT Encryption:** Toggle SRT Encryption on or off.
 - **SRT Password:** Define the SRT password when utilizing SRT Encryption
 - **SRT Bandwidth Overhead:** SRT Bandwidth is a percentage that you assign that helps determine the total bandwidth that the SRT stream will use up. This percentage should not exceed 50%, and is set to 25% by default.
 - **SRT Variable Latency(ms):** Define the maximum buffer size for maintaining SRT packets from the camera to the destination.
- **RTSP Settings**
 - **RTSP Authentication:** Toggle RTSP Authorization on or off.
 - **RTSP Port:** The RTSP Port is how you reach the RTSP video feed(s) of your camera.
- **Multicast Settings**
 - **Multicast Mode:** Toggle Multicast on or off.
***WARNING!** Only use this setting with a network configured for Multicast.*
 - **Multicast Address:** Define the Multicast Address. Recommended format: 234.1.2.[camera IP address last octet]
 - **Multicast Port:** The Multicast Port is how you reach the stream through RTP Multicast.
- **ONVIF Settings**
 - **Enable ONVIF:** Toggle ONVIF control on or off
 - **ONVIF Authentication:** Toggle ONVIF Authentication on or off

Profile Settings

The **Profile Settings** page gives you access to the **Logo Upload**, **Profile Configuration**, **Quick Profiles**, **Custom CSS** & **Tutorial Mode** sections.

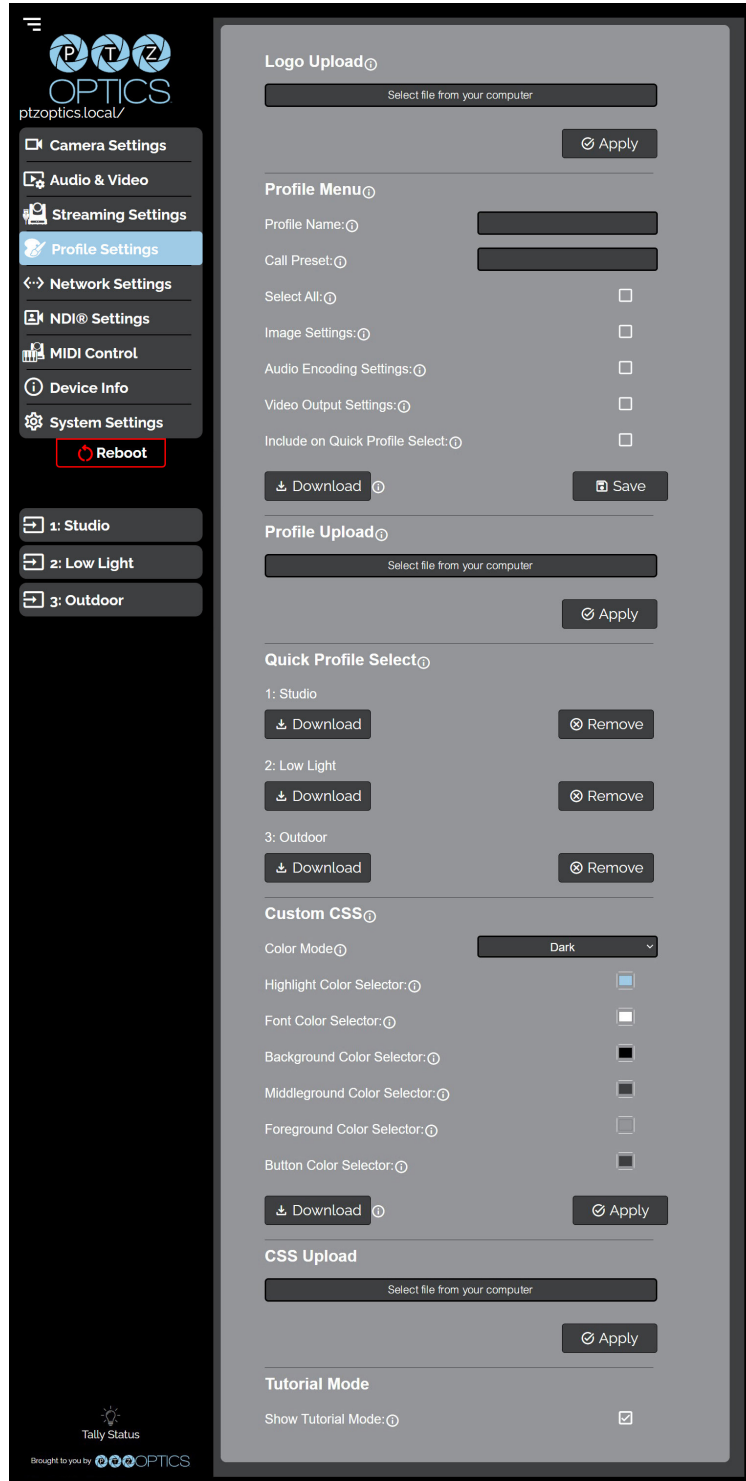

The screenshot displays the PTZ OPTICS web interface for Profile Settings. On the left is a dark sidebar with a navigation menu containing: Camera Settings, Audio & Video, Streaming Settings, Profile Settings (highlighted), Network Settings, NDI® Settings, MIDI Control, Device Info, System Settings, and a Reboot button. Below the menu are three profile selection buttons: 1: Studio, 2: Low Light, and 3: Outdoor. The main content area is a light gray panel with the following sections:

- Logo Upload:** A file selection field with the text "Select file from your computer" and an Apply button.
- Profile Menu:** Fields for Profile Name and Call Preset, followed by checkboxes for Select All, Image Settings, Audio Encoding Settings, Video Output Settings, and Include on Quick Profile Select. Includes Download and Save buttons.
- Profile Upload:** A file selection field with the text "Select file from your computer" and an Apply button.
- Quick Profile Select:** A list of three profiles: 1: Studio, 2: Low Light, and 3: Outdoor. Each profile has a Download button and a Remove button.
- Custom CSS:** A Color Mode dropdown set to "Dark", followed by color selection fields for Highlight, Font, Background, Middleground, Foreground, and Button. Includes Download and Apply buttons.
- CSS Upload:** A file selection field with the text "Select file from your computer" and an Apply button.
- Tutorial Mode:** A checkbox labeled "Show Tutorial Mode:" which is currently checked.

At the bottom left of the interface, there is a "Tally Status" indicator and the text "Brought to you by PTZ OPTICS".

- **Logo Upload**
 - **Upload File:** Browse your PC for an image file you'd like to upload to the camera's web interface. The resolution of this logo should be 2500x1000 and PNG or JPG type file.
- **Profile Menu**
 - **Profile Name:** Give your Profile a unique name so you can easily remember.
 - **Call Preset:** Select a preset to be called when the Profile is loaded. This field is optional.
 - **Select All:** Select all of the below options in the Profile Menu section.
 - **Image Settings:** Select whether the Image Settings on the Camera Settings page are stored in the Profile.
 - **Audio Encoding Settings:** Select whether the Audio Settings on the Audio & Video Settings page are stored in the Profile. This will require a camera reboot when loaded.
 - **Video Output Settings:** Select whether the Video Settings on the Audio & Video Settings page are stored in the Profile. This will require a camera reboot when loaded.
 - **Network Settings:** Select whether the settings on the Network Settings page are stored in the Profile. This will require a camera reboot when loaded.
 - **Device Settings:** Select whether the settings on the Device Info page are stored in the Profile. This will require a camera reboot when loaded.
 - **Include on Quick Profile Select:** Select whether the Profile is displayed in the Quick Profile Select section on the Navigation Panel.
 - **Download:** Download the profile from the Profile Menu section.
 - **Save:** Save the configured Profile. The Include on Quick Profile Select checkbox needs to be checked in order to save the Profile to the camera.
- **Profile Upload**
 - **Upload File:** Upload a saved Profile from your computer to the camera.
- **Quick Profile Select**
 - **Download Button:** Download the selected Profile to your computer.
 - **Remove Button:** Remove the selected Profile from the camera.
- **Custom CSS**
 - **Color Mode:** Select the color mode of the Web UI. Custom allows you to define your own colors.
 - **Highlight Color Selector:** Define the color that buttons glow while hovering over or pressing the buttons.
 - **Font Color Selector:** Define the font color.
 - **Background Color Selector:** Customize the background color of the Web UI.
 - **Middleground Color Selector:** Customize the middleground color of the Web UI.
 - **Foreground Color Selector:** Customize the foreground color of the Web UI.
 - **Button Color Selector:** Customize the button background and text field color of the Web UI.
 - The colors can be defined by using the eyedropper tool, decimal code, HSL code, or hex code.
- **CSS Upload**
 - **Upload File:** Upload a saved Custom CSS file from your computer to the camera.
- **Tutorial Mode**
 - **Show Tutorial Mode:** While checked, the Information Symbols and associated text will be available, giving a description of each available setting.

Network Settings

The **Network Settings** page accesses the **LAN Settings** & **NTP Settings** sections.

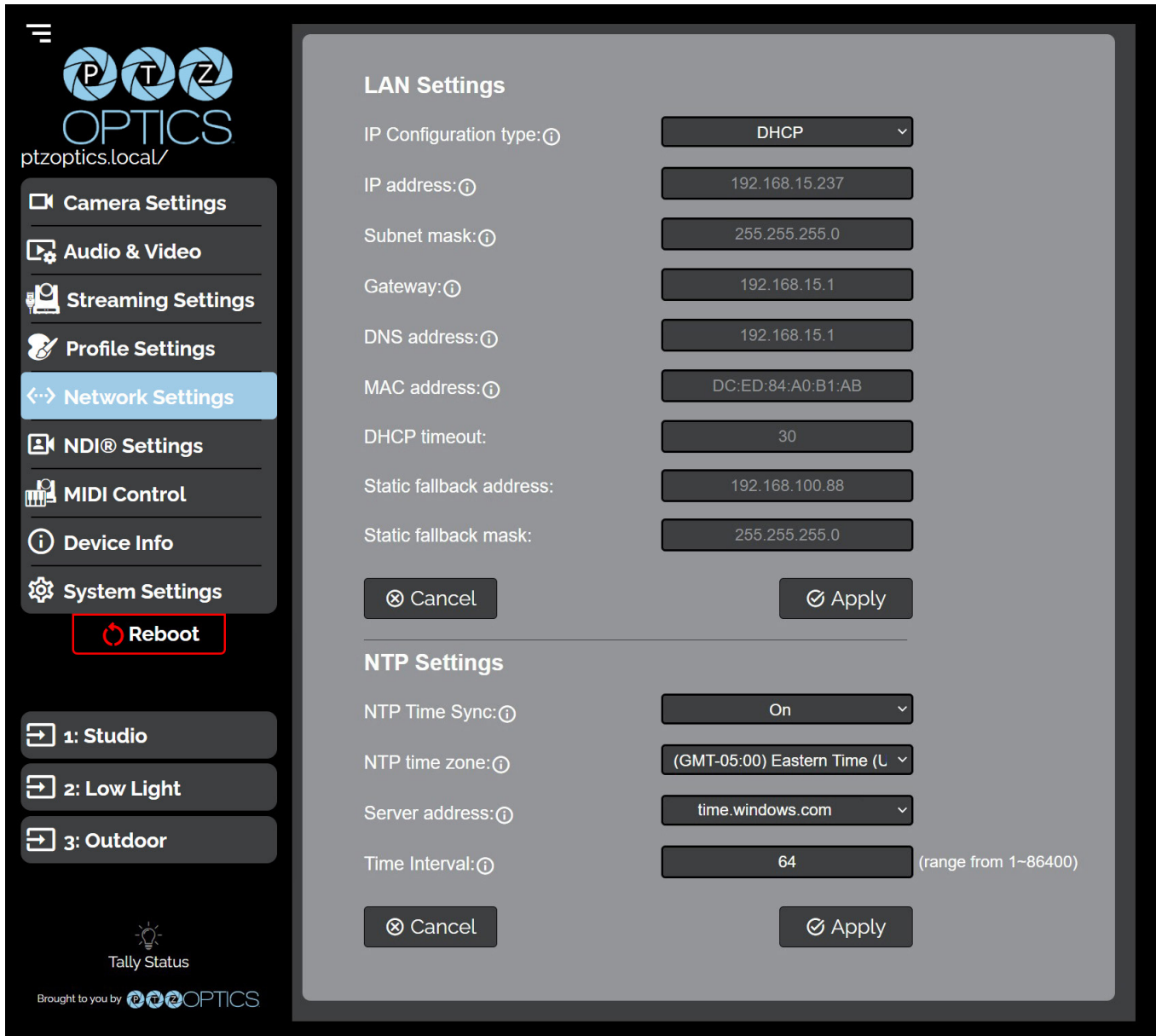

PTZ OPTICS
ptzoptics.local/

- Camera Settings
- Audio & Video
- Streaming Settings
- Profile Settings
- Network Settings**
- NDI® Settings
- MIDI Control
- Device Info
- System Settings
- Reboot

- 1: Studio
- 2: Low Light
- 3: Outdoor

Tally Status
Brought to you by **PTZ OPTICS**

LAN Settings

IP Configuration type: ⓘ	DHCP
IP address: ⓘ	192.168.15.237
Subnet mask: ⓘ	255.255.255.0
Gateway: ⓘ	192.168.15.1
DNS address: ⓘ	192.168.15.1
MAC address: ⓘ	DC:ED:84:A0:B1:AB
DHCP timeout:	30
Static fallback address:	192.168.100.88
Static fallback mask:	255.255.255.0

Cancel Apply

NTP Settings

NTP Time Sync: ⓘ	On
NTP time zone: ⓘ	(GMT-05:00) Eastern Time (L
Server address: ⓘ	time.windows.com
Time Interval: ⓘ	64 (range from 1~86400)

Cancel Apply

- **LAN Settings**

- **IP Configuration Type:** Select whether the camera automatically configured the network settings (DHCP) or whether you manually configure the network settings (Static).
- **IP Address:** The IP address is a unique address the network uses to connect and configure the camera.
- **Subnet Mask:** The Subnet Mask is a set of numbers that defines how large your network is.
- **Gateway:** The Gateway is the address associated with your router to connect to the internet.
- **DNS Address:** The DNS address is a unique IP address the camera will query when trying to reach a specific website.
- **MAC Address:** The MAC Address is a unique address the Ethernet port utilizes to communicate with the network. You can not change this address.
- **DHCP Timeout:** DHCP Timeout is the amount of time the camera will try to acquire an IP address through DHCP. After this time, the camera will revert to the Static Fallback Address & Static Fallback Mask. You can not change this timeout.
- **Static Fallback Address:** Static Fallback Address is the IP address the camera will revert to if one can't be acquired automatically. You can not change this address.
- **Static Fallback Mask:** Static Fallback Mask is the Subnet Mask the camera will revert to if one can't be acquired automatically. You can not change this subnet mask.

- **NTP Settings**

- **NTP Time Sync:** Toggle Network Time Protocol (NTP) on or off.
- **NTP Time Zone:** Select your time zone.
- **Server Address:** Define the NTP Server Address you wish to utilize.
- **Time Interval:** Define how frequently NTP queries the server (in seconds).

NDI® Config Settings

The **NDI Config Settings** page accesses the camera's NDI settings.



PTZ OPTICS
ptzoptics.local/

- Camera Settings
- Audio & Video
- Streaming Settings
- Profile Settings
- Network Settings
- NDI® Settings**
- MIDI Control
- Device Info
- System Settings
- Reboot

1: Studio

2: Low Light

3: Outdoor

Tally Status

Brought to you by **PTZ OPTICS**

NDI® Config

NDI® Local Device Name: ⓘ	ptzoptics
NDI® Local Device Channel: ⓘ	Chan 1
NDI® Receive Group: ⓘ	public
NDI® Discovery Server: ⓘ	Off
NDI® Discovery Server Address: ⓘ	192.168.1.2
NDI® Multicast Server: ⓘ	Off
NDI® Multicast Address: ⓘ	239.255.0.10
NDI® Firmware Version: ⓘ	PT5.1.1
NDI® Port: ⓘ	5961

Cancel Apply

- **NDI Config**

- **NDI Local Device Name:** The Local Device Name is the name you assign to your NDI device.
- **NDI Local Device Channel:** The Local Device Channel is the video feed that you assign to your NDI Local Device Name.
- **NDI Receive Group:** The Receive Group defines which devices on a LAN can view the NDI sources. The camera and computer's Receive Group must match in order to view the NDI source. Your camera can be part of multiple groups.
- **NDI Discovery Server:** Toggle the NDI Discovery Server connection on or off. The Discovery Server handles discovering and distributing NDI sources more reliably across your LAN.
- **NDI Discovery Server Address:** Define the Discovery Server IP address.
- **NDI Multicast Server:** Toggle the NDI Multicast Server on or off. NDI Multicast allows for a single NDI source to be viewed across multiple PCs more reliably. **WARNING!** Only use this setting with a network configured for Multicast.
- **NDI Multicast Address:** Define the NDI Multicast Server Address.
- **NDI Multicast Mask:** Define the Multicast Subnet Mask.
- **NDI Multicast TTL:** Define how frequently Multicast Time to Live (TTL) queries (in minutes).
- **NDI Firmware Version:** The NDI Firmware version currently running on the camera.
- **NDI Port:** The NDI Port is how you reach the NDI feed of your camera.

For more information on how to utilize the NDI® Discovery Server, please see :

<https://help.ptzoptics.com/en/support/solutions/articles/13000086877-ndi-discovery-server>

NewTek®, NDI®, NDI® 4, & NDI®|HX are all registered trademarks by Vizrt Group®.

MIDI Control

The **MIDI Control** page accesses the **PTZ Optics MIDI Control, Control Mapping, Mass Command Edit & Information** sections. The MIDI Control page can be reached by accessing the HTTPS version of the camera's web interface. ([https://\[Camera IP\]/](https://[Camera IP]/)). The page must remain open for MIDI Control to function.

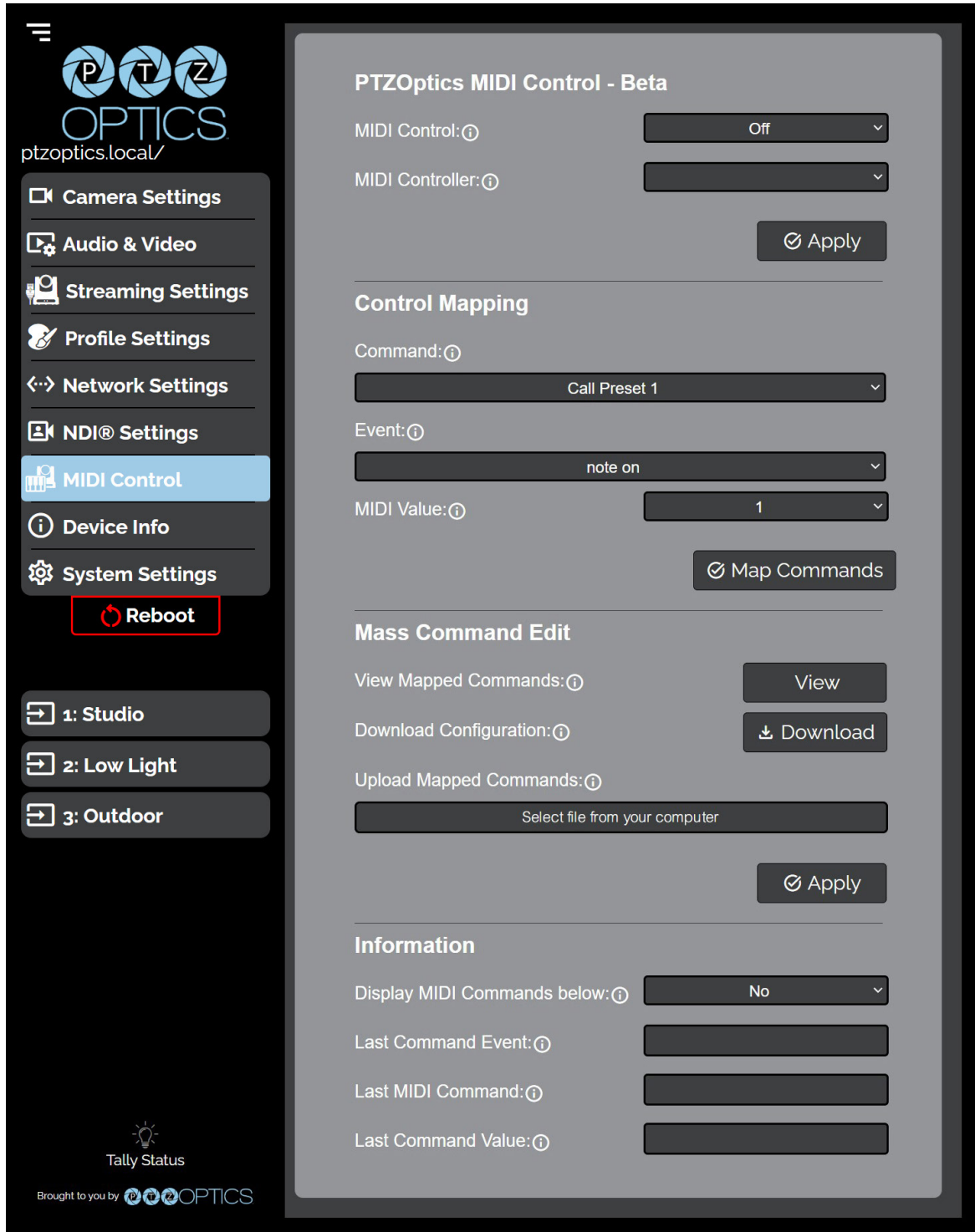

The screenshot shows the PTZ Optics web interface for MIDI Control. On the left is a navigation sidebar with the following menu items: Camera Settings, Audio & Video, Streaming Settings, Profile Settings, Network Settings, NDI® Settings, MIDI Control (highlighted), Device Info, System Settings, and a Reboot button. Below the menu are three scene buttons: 1: Studio, 2: Low Light, and 3: Outdoor. At the bottom of the sidebar is a Tally Status indicator and the PTZ Optics logo.

The main content area is titled "PTZ Optics MIDI Control - Beta" and contains the following sections:

- MIDI Control:** Includes a "MIDI Control" dropdown menu set to "Off" and a "MIDI Controller" dropdown menu. An "Apply" button is located below these settings.
- Control Mapping:** Includes a "Command" dropdown menu set to "Call Preset 1", an "Event" dropdown menu set to "note on", and a "MIDI Value" dropdown menu set to "1". A "Map Commands" button is located below these settings.
- Mass Command Edit:** Includes a "View Mapped Commands" button set to "View", a "Download Configuration" button set to "Download", and an "Upload Mapped Commands" section with a file selection button "Select file from your computer" and an "Apply" button.
- Information:** Includes a "Display MIDI Commands below" dropdown menu set to "No", and three empty input fields for "Last Command Event", "Last MIDI Command", and "Last Command Value".

- **PTZOptics MIDI Control**
 - **MIDI Control:** Toggle MIDI Control on or off.
 - **MIDI Controller:** Select a MIDI Controller that's connected to your PC.

- **Control Mapping**
 - **Command:** What function you'd like the camera to perform.
 - **Event:** How you would like the trigger the command to be sent.
 - **MIDI Value:** The value associated with the button / dial / knob / etc. on the MIDI Controller.

- **Mass Command Edit**
 - **View Mapped Commands Button:** View the commands currently mapped to the camera.
 - **Download Configuration:** Download the commands currently mapped to the camera.
 - **Upload Mapped Commands:** Upload a list of mapped MIDI commands to the camera.

- **Information**
 - **Display MIDI Commands below:** Select whether the camera displays the commands being sent from the MIDI Controller. This is typically used when Control Mapping.
 - **Last Command Event:** The most recent MIDI Event the Controller sent.
 - **Last MIDI Command:** The most recent MIDI Command the Controller sent.
 - **Last Command Value:** The most recent MIDI Value the Controller sent.

Device Info

The **Device Info** page accesses the **Device Information, Power Control, Restore Default & Firmware Upload** sections.

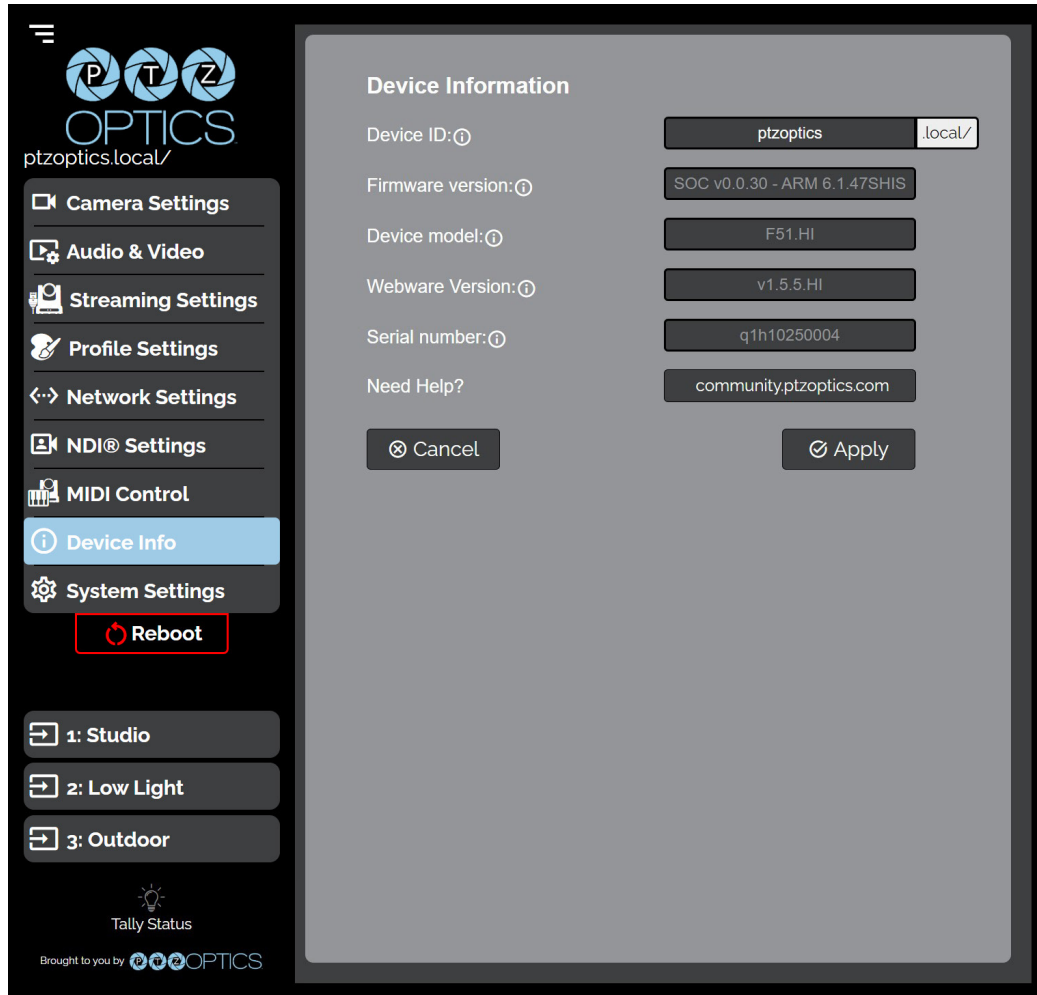

- **Device Information**

- **Device ID:** Define the camera's Device ID to clearly designate which camera you're interacting with. The Device ID is displayed at the top left of the Navigation Panel and anything that queries the camera's name.
- **Firmware Version:** The Firmware Version displays the firmware file currently running on the camera.
- **Device Model:** The Device Model is a field that PTZ Optics uses to designate the camera.
- **Webware Version:** The Webware Version is the version of the web interface.
- **Serial Number:** The camera's serial number.
- **Need Help?** An easy to access URL to the PTZ Optics Knowledge Base.

System Settings

The **System Settings** page gives access to the **HTTPS Settings**, **IR Remote Channel Selection**, **Access Settings**, **Firmware Check**, **Restore Default (Basic)**, **Firmware Upload & Restore Default (Advanced)** sections.

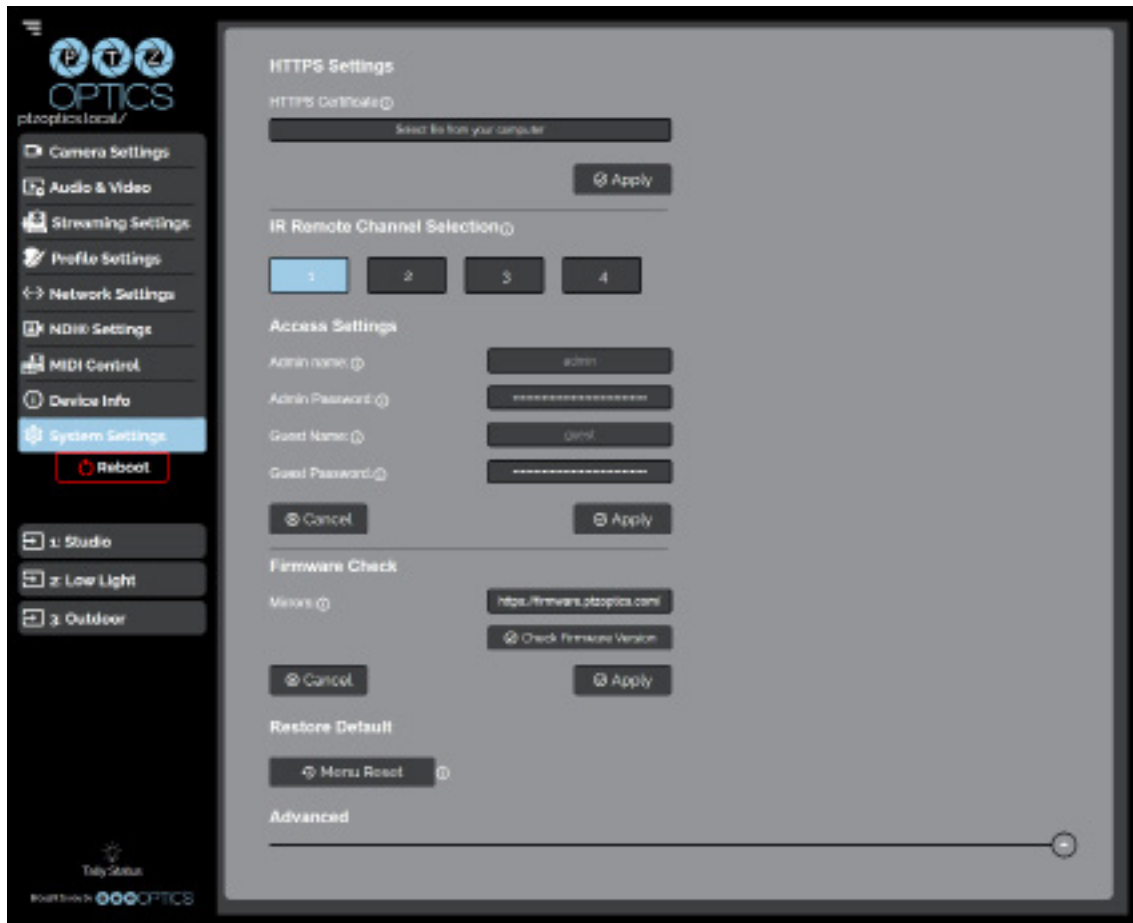

- **HTTPS Settings**
 - **HTTPS Certificate:** Upload a HTTPS Certificate from your computer.
 - **HTTP Port:** The HTTP Port is how you reach the web interface of your camera ([http://\[Camera IP\]:\[port\]/](http://[Camera IP]:[port]/))
- **IR Remote Channel Selection**
 - **1 – 4 Button:** Define the communication channel the camera utilizes with the remote control. This allows you to easily use multiple cameras with a single IR remote.
- **Access Settings**
 - **Admin Name:** Administrator username login. This username can not be changed.
 - **Admin Password:** Administrator password. If you desire to change the password, all letters, numbers, and specifically “!@#%\$%^&*()” can be used, up to 15 characters. Please note the circles in the field are encrypted and do not reflect the password saved on the camera.
 - **Guest Name:** Guest username login. This username can not be changed.
 - **Guest Password:** Guest password. If you desire to change the password, all letters, numbers, and specifically “!@#%\$%^&*()” can be used, up to 15 characters. Please note the circles in the field are encrypted and do not reflect the password saved on the camera.

- **Firmware Check**
 - **Mirrors:** Define a server address for acquiring the latest PTZOptics firmware files. By default, the camera will query PTZOptics at <https://firmware.ptzoptics.com/>
 - **Check Firmware Version:** Check to see if your camera is running the latest firmware from the Firmware Update Server.
- **Firmware Upload**
 - **File Upload (Advanced):** Select a firmware file from your PC to upload to the camera.
- **Restore Default**
 - **Menu Reset (Basic):** Reset the camera's non-network settings to factory default.
 - **Network Reset (Advanced):** Reset the camera's network settings to factory default.
 - **Factory Reset (Advanced):** Reset all of the camera's settings to factory default.



Maintenance and Troubleshooting

Camera Maintenance

1. If the camera will not be used for a long time, power off the camera.
2. Use a soft cloth or lotion-free tissue to clean the camera body.
3. Use a soft, dry, lint-free cloth to clean the lens. If the camera is very dirty, clean it with a diluter neutral detergent. DO not use any type of solvent or harsh detergent which may damage the surface.

Unqualified Applications

1. Avoid shooting at particularly bright objects, such as sunlight, lights, etc. for a long period of time.
2. Do not operate close to powerful electromagnetic radiation, such as TV or radio transmitters, etc.

Troubleshooting

- **No image**
 1. Check whether the power cord is connected, voltage is OK, & Power LED is lit.
 2. Check whether the camera can “self-test” after startup. You can also press [*] > [#] > [Auto Focus] on the IR remote to trigger the camera to perform the startup dance on repeat.
 3. If using SDI or HDMI, check that the desired connection is selected to output video. You can select the desired connection from the OSD Menu or through the Web Interface.
 4. Check that the video cable is connected correctly to th destination device
- **Image is shaky or vibrating**
 1. Check whether the camera is mounted solidly or sitting on a steady horizontal and level surface.
 2. Check the building and any supporting furniture for vibration. Ceiling mounts are often affected by building vibration more than wall mounts. Any external vibration that is affecting the camera will be more apparent when zoomed in.
- **Abnormal display of image**
 1. Check the resolution dial on the back of the camera. Verify that the resolution and refresh rate is supported by your destination device.
 2. If using SDI, check that the SDI level is set to the desired level.
- **Image settings are changing on their own**
 1. The cameras have a feature called “Preset 2.0” where many of the Exposure, White Balance, and Image settings are saved with each preset. When a preset is called, the saved Exposure, White Balance, and Image settings are then loaded.

Control

- **IR Remote controller does not control the camera**
 1. Does one of the four (4) “Camera Select” buttons (top row of remote) light up when you press any of the buttons on the remote?
 - If not, change the batteries in the remote
 2. Are the camera and remote set to the same IR address? When “Display Info” is enabled (within P/T/Z) in the OSD, the camera will display it’s IR address upon start up. Set the IR remote to the same IR address to control the camera.
 3. Try removing other sources of IR interference (e.g. sunlight, fluorescent lighting, etc.)

- **Serial communication does not control the camera**
 1. Make sure the camera is on and functioning with the IR remote controller.
 2. Verify that the RS-232/RS-485 cable is connected correctly and using the proper pinout.
 3. Verify the communication settings of the control software or device (e.g. joystick).
 4. Verify that the communication port on the controlling device is activated (e.g. Com port on PC).
 5. Verify that all communication settings in the OSD Setup Menu correlate to the commands being used (e.g. VISCA address).