

Avolites Quartz

Operator's Manual

Version 10



Useful Avolites phone numbers:-

Avolites England

Sales and service* (+44) (0) 20 8965 8522

Service out of hours* (+44) (0) 7831 178 888

Fax (+44) (0) 20 8965 0290

Email support@avolites.com

Website <http://www.avolites.com>

Before contacting Avolites for service enquiry please ensure that you have the product serial number and the software version. The serial number can be found on the back of the desk; the software version is displayed on the menu prompt when the Quartz is switched to System mode.

The latest version of this manual and console software can be downloaded from the Avolites website.

The small print :

No Liability for Consequential Damages

Avolites has a policy of continuous product and documentation improvement. As such the detail within this manual may not match the operation of the console.

In no event shall Avolites be liable for any direct, indirect, special, incidental, or consequential damages or loss whatsoever (including, without limitation, damages for loss of profits, business interruption, or other pecuniary loss) arising out of the use or inability to use the console even if Avolites Ltd. has been advised of the possibility of such damages. Because some jurisdictions do not allow the exclusion or limitation of liability for consequential or incidental damages, the above limitation may not apply to you.

Avolites Ltd recognise that all trademarks within the manual are the property of their respective owners.

Reprint and revision history:

Titan Universal Manual v10: March 2016

Written by Tim Mitchell, Sabre Technology Ltd
<http://www.sabretechnology.co.uk>
with examples by Nic Morris

SECTIONS

1. QUICK START	15
2. SETTING UP AND USING THE CONSOLE	19
3. PATCHING	49
4. CONTROLLING DIMMERS AND FIXTURES	71
5. PALETTES	97
6. SHAPES AND PIXEL MAPPER EFFECTS	111
7. CUES	149
8. CHASES	171
9. CUE LISTS	183
10. CAPTURE VISUALISER	205
11. RUNNING THE SHOW	211
12. REMOTE CONTROL	227
13. USER SETTINGS AND OTHER OPTIONS	233
14. FIXTURE PERSONALITIES	259
15. NETWORKING THE CONSOLE	263
16. USING DIFFERENT AVOLITES CONSOLES	273
17. RELEASE NOTES	275
18. TITAN COMMANDS QUICK REFERENCE	299
19. GLOSSARY OF WORDS	303



This icon shows important information which you should know about to avoid damage to your console or loss of important data.



This icon shows information which is useful to know.



This icon shows handy tips which will help you use the console more efficiently.

CONTENTS

1.	Quick Start	15
1.1	Patching fixtures	15
1.2	Controlling fixtures	15
1.3	Programming cues and chases.....	16
1.4	Programming palettes	17
1.5	DMX / network setup	18
2.	Setting up and using the console	19
2.1	Guide to the Quartz	19
2.2	Connecting up.....	22
2.2.1	Cautions	22
2.2.2	Connecting mains power	22
2.2.3	Starting up and shutting down.....	22
2.2.4	Titan Healthcheck	22
2.2.5	Connecting DMX lines	23
2.2.6	Connecting console wings	24
2.3	Using the touch screen and monitor	25
2.3.1	Workspace windows	26
2.3.2	The menu area of the touch screen	30
2.3.3	The toolbar	32
2.3.4	The Heads-Up Display (HUD).....	33
2.3.5	Visualiser.....	34
2.3.6	Key profiles	34
2.3.7	Undo/Redo.....	34
2.3.8	Key macro buttons.....	35
2.3.9	Locking the console.....	36
2.3.10	Keyboard shortcuts	36
2.4	Multi-user operation.....	38
2.4.1	Users	38
2.4.2	Handle Worlds.....	38
2.4.3	Linking to other TitanNet sessions.....	39
2.5	Titan Simulator	40
2.5.1	Installing Titan Simulator	41
2.5.2	Running Titan Simulator	41
2.5.3	Using Virtual Panel with a console	42
2.6	Loading and saving shows	42
2.6.1	Saving the show	42
2.6.2	Loading a show.....	43
2.6.3	Importing parts of other shows.....	44
2.6.4	Autosave	46
2.6.5	Backing up existing show files to USB pen drive.....	46
2.7	Clearing the console.....	46
2.8	Creating reports	46
3.	Patching	49
3.1	Patching new fixtures or dimmers	49
3.1.1	Fixture select buttons and handles	49
3.1.2	Patching dimmers	50
3.1.3	Patching moving light fixtures.....	51
3.1.4	Capture Visualiser Auto Patch	54
3.1.5	Patching fixtures with multiple cells (sub fixtures)	54
3.1.6	Patching by RDM.....	55
3.1.7	Finding a lost fixture.....	55
3.2	Changing the patch.....	56
3.2.1	Patch View	56
3.2.2	View detailed fixture information.....	57
3.2.3	Changing DMX addressing using Patch View	58
3.2.4	Changing DMX address using Patch menu	58
3.2.5	Setting legends.....	59
3.2.6	Fixture button halo.....	60
3.2.7	DMX view window	61
3.2.8	Fixture Exchange	62
3.2.9	Exchange Mapping	63
3.2.10	Update personalities	65
3.3	Copying, moving and deleting fixtures	65

3.3.1	Copying or moving a patched fixture	65
3.3.2	Using copied fixtures	66
3.3.3	Deleting a patched fixture	66
3.4	Advanced options	67
3.4.1	Swap pan and tilt.....	67
3.4.2	Invert attributes	67
3.4.3	Attribute limits.....	68
3.4.4	Fixture Offset	68
3.4.5	Fixture / Attribute curves	69
3.4.6	Freeze fixtures or attributes	69
3.4.7	Editing the personality	70
4.	Controlling dimmers and fixtures	71
4.1	Using the select buttons and wheels.....	71
4.1.1	Selecting fixtures and dimmers for control	71
4.1.2	Setting fixtures to a start position (Locate).....	72
4.1.3	Clearing selection.....	73
4.1.4	Fixtures with multiple cells/subfixtures	74
4.1.5	Changing attributes using the wheels	75
4.1.6	Setting attributes on the touch screen	77
4.1.7	Setting attributes from the softkeys	80
4.1.8	Adjusting attributes with the @ buttons	80
4.1.9	Selecting fixtures and dimmers by number (Channel)	81
4.1.10	Selecting using a pattern.....	82
4.1.11	Selecting fixtures which are in a palette or playback	82
4.1.12	Attribute groups – IPCGBES-FX.....	83
4.1.13	Stepping through selected fixtures one at a time.....	83
4.1.14	Highlighting the selected fixture with Prev/Next	84
4.1.15	Flash selected fixtures to full	84
4.1.16	Turn off unselected fixtures	84
4.1.17	Align fixtures	84
4.1.18	Flip.....	85
4.1.19	Fan mode.....	85
4.1.20	Setting fixture/attribute times.....	88
4.2	Viewing and editing fixture values.....	89
4.2.1	The Channel Grid window.....	89
4.2.2	Intensity window	90
4.3	Fixture groups.....	92
4.3.1	Using fixture groups	92
4.3.2	Fixture Order and Fixture Layout in groups.....	93
4.4	Advanced options	95
4.4.1	The ML Menu button.....	95
4.4.2	Lamping fixtures on and off.....	95
5.	Palettes	97
5.1	Creating palettes	98
5.1.1	Which attributes are stored in palettes.....	98
5.1.2	Storing a palette.....	98
5.1.3	Nested palettes.....	101
5.1.4	Quick record.....	101
5.1.5	Setting legends for palettes.....	102
5.1.6	Creating an effects palette (shape or pixel mapper).....	103
5.1.7	Creating a time palette	103
5.2	Recalling palettes	104
5.2.1	Recalling a palette value	104
5.2.2	Palette pages	104
5.2.3	Only showing relevant palettes	105
5.2.4	Quick palettes with no fixtures selected	105
5.2.5	Setting palettes to all fixtures in a playback	105
5.3	Editing palettes	105
5.3.1	Viewing and editing the content of palettes	105
5.3.2	Changing the content of palettes.....	106
5.3.3	Updating palettes used in a playback.....	106
5.4	Copying, moving and deleting palettes	107
5.4.1	Copying or moving a palette.....	107
5.4.2	Deleting palettes.....	107
5.5	Timing with palettes.....	108
5.5.1	Palettes with saved times.....	108
5.5.2	Manually overriding palette times.....	108

5.5.3	Manual fixture overlap when recalling palettes	108
5.5.4	Master Time for palettes	109
6.	Shapes and Pixel Mapper effects	111
6.1	Shape generator.....	111
6.1.1	Selecting a shape.....	112
6.1.2	Changing size and speed of a shape	113
6.1.3	Changing the phase of a shape across multiple fixtures.....	114
6.1.4	Shape direction	115
6.1.5	Using shapes in cues	115
6.2	Key frame shapes	116
6.2.1	Creating a key frame shape.....	116
6.2.2	Changing shape parameters in the Effect Editor	117
6.2.3	Saving a key frame shape to a cue.....	120
6.3	Pixel mapper.....	121
6.3.1	Creating Pixel Mapper effects.....	121
6.3.2	Pixel mapper Layer Masters.....	124
6.4	Editing shapes and effects	125
6.4.1	Editing shapes and effects in cues	125
6.4.2	Selecting a running shape to edit	125
6.4.3	Resynchronise shapes	125
6.4.4	Changing fixture order in a shape	126
6.4.5	Removing or adding fixtures.....	126
6.4.6	Reversing a shape.....	126
6.4.7	Deleting shapes	126
6.5	Advanced options	126
6.5.1	Fading shape size and speed	126
6.6	Pixel Mapper examples	127
6.6.1	Randomising effects	127
6.6.2	Overlaying effects	130
6.6.3	Creative use of fixture layouts	133
6.6.4	Other Layout Editor tools	137
6.6.5	Playback Order and Priorities.....	138
6.6.6	Displacement and Layer Properties.....	142
6.6.7	Spawn and Pre-Spool	145
7.	Cues	149
7.1	Creating a cue.....	149
7.1.1	How the Quartz works when programming	149
7.1.2	Creating a cue.....	150
7.1.3	Quick Build cues	150
7.1.4	Using shapes/effects in cues.....	151
7.1.5	Blind mode.....	151
7.1.6	Recording cue with a mask.....	151
7.1.7	Convert cue to chase or cue list	151
7.2	Using a cue.....	152
7.2.1	HTP and LTP.....	152
7.2.2	Playing back a cue	152
7.2.3	Changing playback pages.....	153
7.2.4	Viewing active playbacks	153
7.2.5	Speed and Size Masters	154
7.2.6	Releasing running playbacks.....	155
7.2.7	Releasing a whole page of playbacks	155
7.2.8	Release mask - releasing individual attributes.....	155
7.2.9	Programming the Release / Power On state.....	156
7.2.10	Turning off individual fixtures	156
7.3	Editing cues	157
7.3.1	Editing a cue by merging	157
7.3.2	Updating stored values and palettes used in a cue	157
7.3.3	Playback and Cue view	158
7.3.4	Using parts of existing cues - the Include function.....	160
7.3.5	Removing attributes from cues using "Off"	160
7.4	Copying, moving, linking and deleting	161
7.4.1	Copying or moving a cue	161
7.4.2	Deleting a cue	162
7.5	Cue timing.....	162
7.5.1	Setting fade times and Overlap for a cue	162
7.5.2	Changing fixture order.....	164
7.5.3	Setting attribute fade times for a cue	165

7.5.4	Editing times in the programmer.....	166
7.6	Playback options	166
7.6.1	Playback options - Playback	167
7.6.2	Playback options - Handle	168
7.6.3	Playback options - Fader	168
7.6.4	Playback options - Effects	169
7.6.5	Playback options - Release	169
8.	Chases	171
8.1	Creating a chase	171
8.1.1	Programming a chase	171
8.1.2	Creating a chase with Quick Build	172
8.2	Playback	172
8.2.1	Playing back a chase	172
8.2.2	Connecting a chase for control.....	173
8.2.3	Setting speed and crossfade for a chase	173
8.2.4	Manually controlling the steps of a chase	174
8.2.5	Changing chase direction	174
8.2.6	Jumping to a step	174
8.3	Editing a chase.....	175
8.3.1	Opening a chase for editing.....	175
8.3.2	Editing a chase using Unfold	175
8.4	Copying, moving, linking and deleting	176
8.4.1	Copying or moving a chase	176
8.4.2	Deleting a chase	176
8.4.3	Deleting a step from a chase	176
8.5	Chase timing.....	176
8.5.1	Global timings for chases	176
8.5.2	Individual cue times in chases	178
8.5.3	Setting attribute fade times for a cue in a chase	179
8.6	Chase options	179
8.6.1	Chase options - Playback	180
8.6.2	Chase options - Handle	180
8.6.3	Chase Options - Effects	181
8.6.4	Chase Options - Release	181
8.6.5	Renumber All Cues.....	181
9.	Cue Lists	183
9.1	Creating a cue list.....	183
9.1.1	Programming a cue list	183
9.1.2	Changing legends for cues in a cue list	185
9.1.3	Shape tracking in cue lists.....	185
9.1.4	Autoloading a playback within a cue list	186
9.1.5	Running a key macro from a cue list.....	187
9.1.6	Keyboard shortcuts/syntax for cue lists.....	187
9.2	Cue List playback	187
9.2.1	Running a cue list	187
9.2.2	Killing a cue list	189
9.2.3	Tracking	189
9.2.4	Move In Dark (MID) functions.....	190
9.3	Editing cue lists	191
9.3.1	Playback View window	191
9.3.2	Editing values in Cue View window	191
9.3.3	Moving and copying cues	191
9.3.4	Editing a cue list using Unfold	192
9.3.5	Using Update to change tracked cues	193
9.3.6	Editing a cue list which is running	193
9.3.7	Editing a cue list while recording	194
9.3.8	Updating values in a range of cues	194
9.3.9	Disabling a cue	195
9.4	Copying, moving, linking and deleting	195
9.4.1	Copying or moving a cue list	195
9.4.2	Deleting a cue list	195
9.4.3	Deleting a cue from a cue list	195
9.5	Cue list timing.....	195
9.5.1	Time and fade options for Cue Lists.....	195
9.5.2	Cue linking & Link Offset.....	196
9.5.3	Individual attribute fade times.....	197
9.5.4	Fixture overlap	198

9.5.5	Running a cue list to timecode	199
9.6	Cue list options	200
9.6.1	Cue List options - Playback.....	200
9.6.2	Cue list options - Handle	201
9.6.3	Cue list options - Fader.....	201
9.6.4	Cue list options - Effects.....	201
9.6.5	Cue list options - Release.....	201
9.6.6	Renumber all cues	202
9.6.7	Cue Options	202
10.	Capture visualiser	205
10.1	Setting up the rig	205
10.1.1	Setting up the stage and rigging	205
10.1.2	Setting up fixtures.....	206
10.1.3	Setting up cameras (views)	207
10.1.4	Capture Appearance options	208
10.2	Visualising using Capture	209
10.2.1	Fixture selection.....	209
10.2.2	Camera views.....	209
10.3	Capture Show files.....	209
10.3.1	Exporting shows.....	209
10.3.2	Importing shows	210
10.3.3	Clearing the capture show	210
11.	Running the show	211
11.1	Playback controls.....	211
11.1.1	Back up the show.....	211
11.1.2	Label the console	211
11.1.3	Master faders	211
11.1.4	Speed and Size Masters	211
11.1.5	Group Masters	212
11.1.6	Flash and swop buttons	213
11.1.7	Playback priority	213
11.1.8	Locking a playback onto the same handle on every page.....	213
11.1.9	Viewing active playbacks.....	214
11.1.10	Blind mode	214
11.1.11	Busking with palettes.....	215
11.2	Using multiple on-screen workspaces	216
11.2.1	View menu	216
11.3	Organising the console	216
11.3.1	Using the Move function.....	216
11.4	Set List window	216
11.4.1	Creating a Set List.....	217
11.4.2	Configuring tracks	217
11.4.3	Track Workspace and Macro links.....	218
11.4.4	Playback control Macros	218
11.5	MIDI, DMX or audio triggering	219
11.5.1	Connecting remote trigger sources	219
11.5.2	Setting up remote triggering.....	219
11.5.3	Classic Pearl MIDI triggers.....	221
11.5.4	MIDI show control	222
11.5.5	Audio control (sound to light)	222
11.6	Linking consoles for multi-user or backup.....	223
11.6.1	Setting up consoles for multi-user	223
11.6.2	Setting up consoles for backup	223
12.	Remote control	227
12.1	Setting up the remote	227
12.1.1	Using an existing network	228
12.1.2	Network setup using a dedicated access point.....	228
12.2	Operating the remote.....	229
12.2.1	Keypad	229
12.2.2	Controlling fixtures.....	230
12.2.3	Recording groups and palettes.....	231
13.	User Settings and other options	233
13.1	The System menu	233
13.1.1	TitanNet Security	233

13.1.2	Network Settings	233
13.1.3	User Settings	233
13.1.4	Key Profiles	233
13.1.5	Wipe.....	233
13.1.6	DMX settings	234
13.1.7	DMX Merge Settings	234
13.1.8	Triggers	234
13.1.9	Display Setup	234
13.1.10	Assign mastering.....	234
13.2	Configuring workspaces	234
13.2.1	Opening workspace windows	234
13.2.2	Selecting and positioning workspace windows	234
13.2.3	Controlling button layout.....	237
13.2.4	Saving workspaces	237
13.2.5	Compatibility windows for Pearl Expert shows	238
13.2.6	Configuring an external monitor.....	239
13.3	Show Library window	240
13.3.1	Show Library tab.....	240
13.3.2	Mapping shows for import	241
13.3.3	Users tab	241
13.3.4	Key profiles display	241
13.4	Key Profiles	242
13.4.1	Creating and editing key profiles	242
13.4.2	Selecting a Key Profile	244
13.4.3	Individual Key profiles for playbacks.....	244
13.5	User Settings	244
13.5.1	General.....	244
13.5.2	Handles	245
13.5.3	Key Profiles	245
13.5.4	Patching.....	245
13.5.5	Times	246
13.5.6	Formatting	246
13.5.7	Palettes	246
13.5.8	Release.....	247
13.5.9	Clear	247
13.5.10	Effects	247
13.5.11	LEDs.....	247
13.5.12	Timecode	248
13.5.13	Wheels.....	248
13.6	DMX output mapping	248
13.6.1	Configuring DMX outputs.....	249
13.6.2	TitanNet Overview.....	250
13.6.3	DMX merge	251
13.7	Curves	251
13.8	Upgrading the software	255
13.9	Recovering/reinstalling the system.....	256
13.9.1	Bootting from USB recovery stick	256
13.9.2	Installation Instructions	256
13.9.3	Software licensing	257
14.	Fixture Personalities	259
14.1.1	Downloading fixture personalities from Avolites.....	259
14.1.2	Updating the personality library on the console	260
14.1.3	User/custom personalities	260
14.1.4	Requesting a new fixture personality	261
14.1.5	Reporting a personality bug to Avolites	261
14.1.6	In an emergency.....	261
15.	Networking the console	263
15.1	Controlling fixtures over a network.....	263
15.1.1	Setting the console's IP address.....	263
15.1.2	Setting up DMX outputs	264
15.1.3	A simple Art-Net system	264
15.1.4	Setting up an Art-Net system.....	265
15.1.5	Additional Art-Net Resources	267
15.2	Connecting to a simulator with ACDI	267
15.2.1	ACDI	267
15.3	Module Setup.....	268
15.4	Using Active Fixtures with C1TP	269

15.5	15.4.1 Example CITP setup	269
	All about IP addressing	269
	15.5.1 Setting your IP address.....	270
	15.5.2 Subnet Masks	270
	15.5.3 Choosing an IP address and Subnet Mask.....	270
	15.5.4 Automatically assigning IP addresses (DHCP).....	271
	15.5.5 Private IP address ranges.....	271
16.	Using different Avolites consoles	273
16.1	The console controls	273
16.2	Programming features in Titan	273
17.	Release notes	275
17.1	Version 10.0	275
	17.1.1 Upgrade procedure.....	275
	17.1.2 New Features in v10.0	276
	17.1.3 Improvements in v10.0.....	293
	17.1.4 Changes in v10.0	294
	17.1.5 Bugs fixed in v10.0	295
18.	Titan Commands quick reference	299
	18.1.1 Fixtures	299
	18.1.2 Select If.....	300
	18.1.3 Record.....	300
	18.1.4 Copy, Move	301
	18.1.5 Delete.....	301
	18.1.6 Include	301
	18.1.7 Times	301
	18.1.8 Cue Lists.....	302
19.	Glossary of words	303
INDEX		309

1. Quick Start

This section is a quick guide on how to do most things on the Quartz . Each section has a link to take you to the appropriate manual section for more details.

Softkeys are shown in square brackets like [This].

1.1 Patching fixtures

Press Patch, [Dimmers] or [Fixtures].

For Fixtures, from the softkeys choose fixture manufacturer (type on keyboard to filter the list) then fixture type, then fixture mode.

Set [DMX Line] and [Address]. Console will automatically set these if you don't change them.

Press buttons in the Fixtures window to patch the fixture. (Section 3.1.3, p51).

To patch a number of dimmers or fixtures at once, drag over buttons to draw a selection box on the screen. Or, set [Quantity] in the patch menu.

To change DMX address or line, use [Repatch Fixtures]. (Section 3.2, p56).

View fixture patch

To see an overview screen of how the console is patched, press Window Open then Patch (Section 3.2.1 , p56).

Setting fixture options

Press Patch, [Edit Fixtures], or use the Patch View screen.

1.2 Controlling fixtures

Select fixtures for control by pressing select buttons.

Press Locate to "home" selected fixtures with lamp on. (Section 4.1.2. p72). Hold locate and press attribute button to remove that attribute from the locate (e.g. to locate without changing pan/tilt, hold Locate and press Pan/Tilt).

Select attribute to control using attribute bank buttons (labelled Intensity/Dimmer, Colour, Gobo etc), then turn the wheels to set fixture. Display shows which attribute each wheel is controlling. (Section 4.1.5, p75).

Open Attribute window onscreen (Window Open, Attribute Options) to select attributes from buttons and to control subfixtures of battens/arrays. (Section 4.1.6, p77).

Use Palettes to store often-used colours, positions etc. for instant recall, see next page.

Fixture Groups

Fixtures may be grouped for quick selection, press Group, [Record Group], select fixtures for group, set legend using [Provide a legend], press a handle to store. If the handle has a fader it becomes a master

fader for the group. Order of fixture selection is remembered for use with shapes. (Section 4.3.1, p92).

Shapes / effects

Titan can use preset shapes, patterns you create yourself (key frame shapes) or pixel mapped patterns.

Select fixtures. The order of fixture selection is used by shapes.

At top menu press [Shapes and Effects], [Shape Generator], [Create]. Select attribute of shape then select a shape to run. (Section 6.1.1, p112).

Or from the Shape Library window (Window Open, [Open Workspace Window], [Shape Library]) you can select a shape directly. Filter the list of shapes using the attribute buttons.

Use the wheels and [Adjust Speed, Size and Phase]/[Adjust Phase, Spread and Offset] to configure the shape. Spread distributes the shape across a number of fixtures.

Key frame shapes are similar to a chase but you can spread the sequence across fixtures (Section 6.2, p116).

To use Pixel Mapper, save fixtures to a group, select the group. Use Layout Editor to set the real-world layout of the fixtures. Then use Effects Editor to create effects on the pixels. (Section 6.6, p127).

1.3 Programming cues and chases

Cues

Set up the look to be recorded.

Press Record.

Set [Record Mode] to Channel (saves only modified attributes), Fixture (saves all attributes of fixtures which have been modified or are selected), Stage (saves all attributes of all fixtures with nonzero dimmer), or Quick Build (merges palettes and playbacks into the cue when you select them).

To store, press blue Select button on playback fader, or press button in Playbacks window. (Section 7.1.2, on p150).

Chases

Press Record twice (or Record then [Create Chase]) .

Press blue Select button on a playback fader, or press button in Playbacks window.

Set up the look for the first step, press playback select button to store. Repeat until all steps stored. Quick Build mode can be used to merge palettes and cues into chase steps.

Press Exit to finish storing chase steps. (Section 8.1.1, 171).

Timings

All times (cue times and fixture attribute times) are stored in the programmer and are saved when you store a cue.

To edit times in the programmer before saving, press the Times button (previously labelled "Set" on Quartz/Titan Mobile/Sapphire

Touch/Tiger Touch and "Next Time" on Pearl Expert/Tiger Touch mk1).

For chases, speed and fade can be set with wheels A and B when the chase is running.

To edit times in a saved cue, at top level menu press [Edit Times] then the select button for the playback. Timing options are set from softkeys.

[Fixture Overlap] sets each fixture to fade in sequence (100%=all together, 0%=fixture waits for previous one to complete).

[Attribute times] sets individual fade times for different attributes.

[Fixture order] changes sequence for shapes and Overlap. (Section 8.5, p176).

Cue Lists

Cues may be stored in a Cue List which allows a full show to be run from a Go button. Chases can be included using Autoload. Cue lists can run in tracking or non-tracking mode, set from [Playback Options].

1.4 Programming palettes

Set up the attributes to be recorded. If attribute is the same for all fixtures of one type (e.g. colour), only one fixture need be set up and palette will be "shared".

Press Record, Palette.

Use [Set Mask] to choose attributes to record/exclude. If you are storing in a palette touch button the mask is automatically set.

Press a grey palette button to store, or touch a button in one of the Colours/Positions/Gobos windows. (Section 5.1.2, p98).

To recall palette, select fixtures, select recall mask using Attribute Bank buttons, press palette button.

To set a legend, press [Set Legend] then the palette's button. Press [Picture] to draw a picture legend.

Quick Record

Press an unused button in one of the windows – the button turns red with a +. Press again to save the palette. The mask is automatically set to match the window (e.g. Positions window is masked for only position attributes).

Busking with palettes

To fade palettes when busking a show, select fixtures, type fade time on the keypad then recall the palette (you have to do this each time). If no fixtures selected, palette will recall to all applicable fixtures.

To set fixture overlap, type 0-100 then press [Set Overlap], then recall the palette.

To set a fade time for all palettes, press Palette then [Master Time]. (Section 5.5, p108). Faded palettes do not go into the programmer so don't use fades when programming.

1.5 DMX / network setup

The console can output up to 12 universes of DMX (called DMX Lines) which may be routed to the 4 XLR sockets or over Ethernet. The Pro versions of Pearl Expert and Tiger Touch can output 16 Universes. The Titan One dongle is limited to a single universe. By connecting further Titan Processing Nodes to the network using TitanNet, you can control up to 64 universes.

Multiple consoles can be linked by Ethernet to provide a multi-user system, or to provide tracking backup (Section 11.6,p223).

Switch to System mode by holding Avo and pressing Disk, press [DMX Settings].

Select a Node on the left (where the DMX is going to), click the blue arrow. On the right, select the DMX line it will be fed by. The 'i' buttons set properties for Nodes/Lines. (Section 5.5, p249).

To change the IP address of the console, press [Network Settings] in System mode (Section 15.1.1, p263).

To change User Settings which let you personalise how the console works, hold down Avo and select [User Settings] (Section.13.1.3, p233).

2. Setting up and using the console

Welcome to the Quartz from Avolites. This manual is a reference guide to all the functions of the console.

We explain things in the order you're most likely to use them, so we start with how to set up the console, then look at patching lights, controlling lights and how to program cues.

2.1 Guide to the Quartz

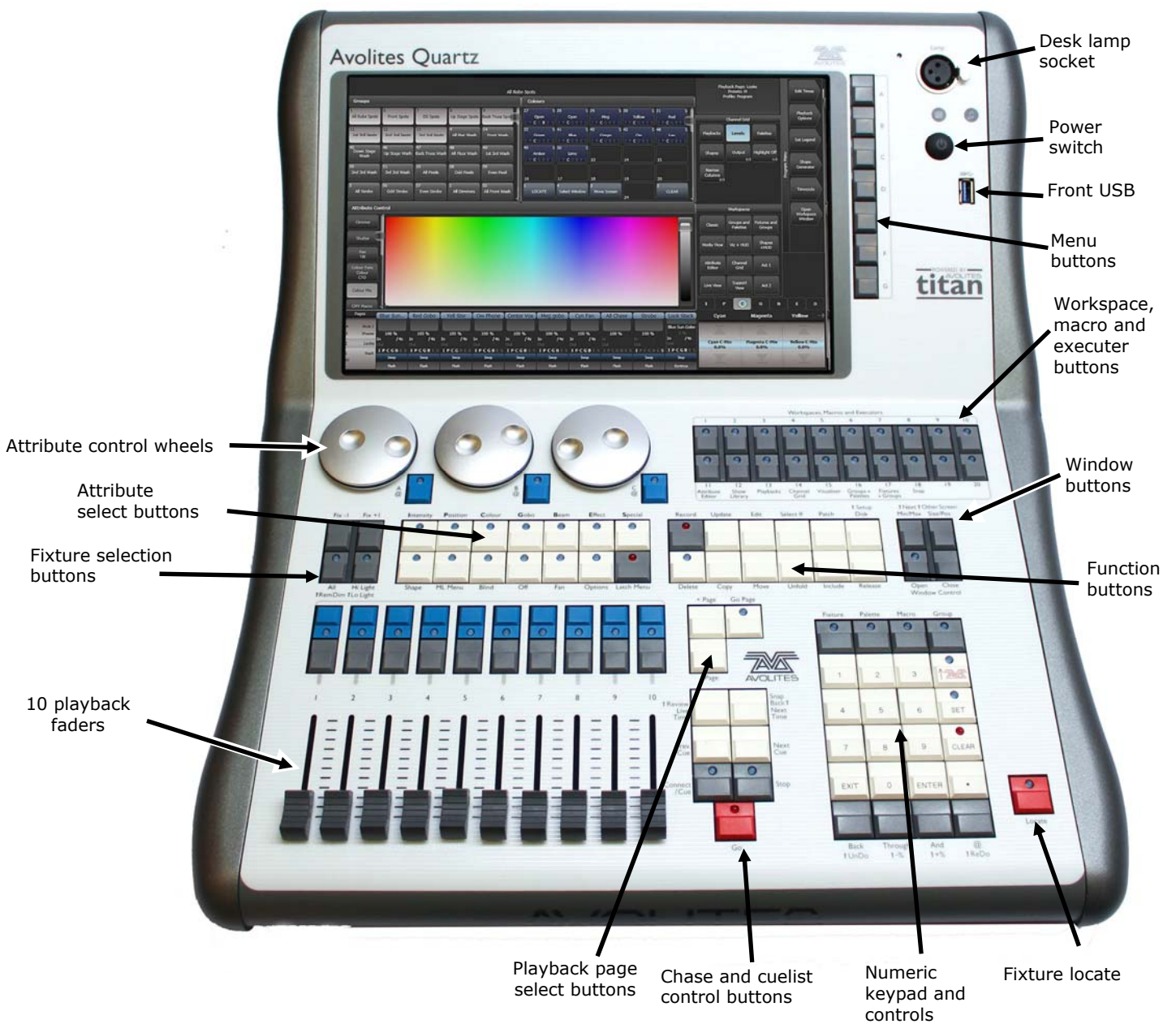

- The **Playback faders** are used to store and play back cues or chases. The **Page Select buttons** let you change to a different page of playbacks. The bottom of the screen shows information about each playback.
- The **Attribute Control wheels** are used to set control values (attributes) for the fixtures, and to set chase speeds and fades. The bottom right corner of the screen shows information about the attributes being controlled.
- The **Attribute select buttons** are used to select which attributes of a fixture (e.g. colour, gobo, position) are going to be controlled using the Control wheels. The buttons have lights on to show you which attributes are active. Attribute functions such as Fan and Shapes are also controlled here.
- The **Chase and Cuelist control buttons** allow you to start and stop chases and cuelists, and move about in the list.
- The **Numeric keypad** and other control buttons are used to enter values and change controls on the system.
- The **Function buttons** are used to carry out functions such as storing cues, copying, saving to disk, etc.
- The **Workspaces, Macros and Executors** buttons are programmable buttons which can be used to store workspaces (screen layouts), button macros or cues.
- The **Workspace Window select buttons** are used to set which windows are shown on the screen.

The screen

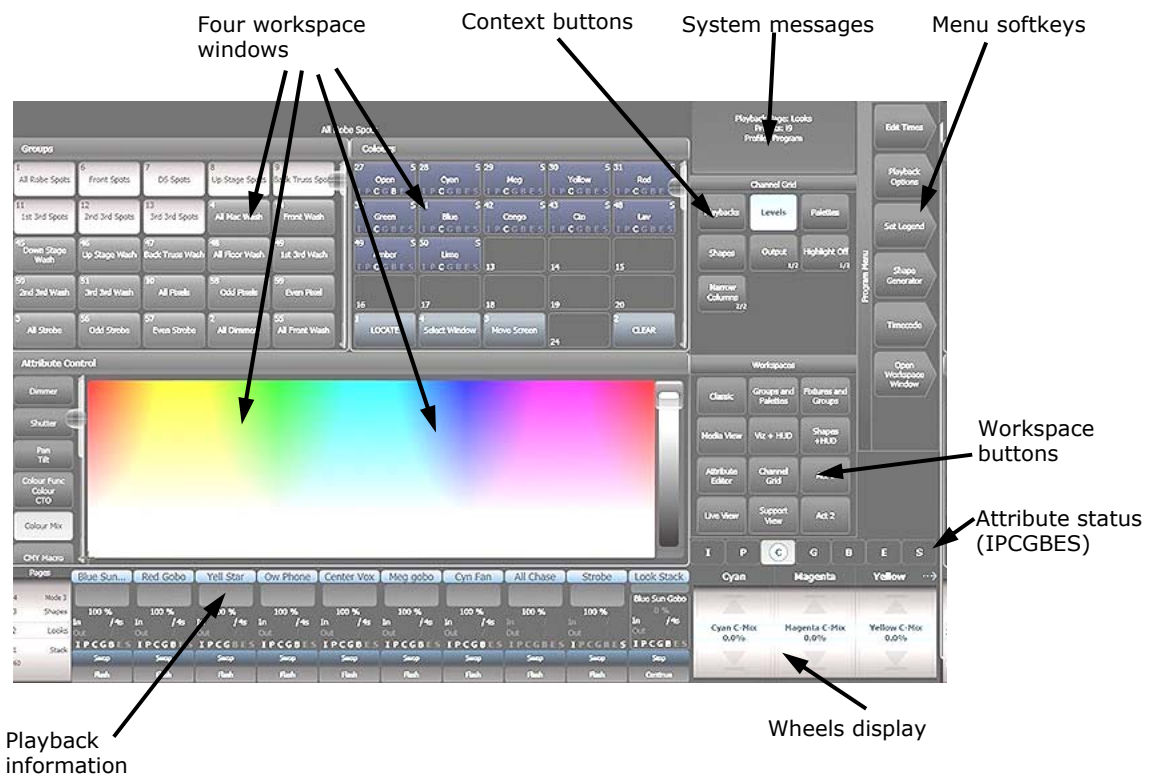

The touch screen shows all the information required to operate the console.

- Up to four **Workspace Windows** may be shown on the screen. These contain touch buttons to control fixture selection, palette selection, groups, shapes, attributes, and so on. Visualiser may also be shown in a window.
- The system **Menu softkeys** are down the top right hand side. You can select these by touching or clicking them, or by using the physical menu buttons on the right hand edge of the screen.
- **System prompts** are shown just to the left of the menu keys. Below that are **Context buttons** which appear when relevant to the operation you are doing.
- The **Workspace Buttons** allow you to quickly select and save different workspace screen layouts.
- The **Wheels display** shows the current attributes available on the 3 wheels. The **Attribute status display** above that shows which attributes are currently active or modified.
- The **Playback information** shows the legend and other information about the playbacks on the 10 faders.

Connections panel

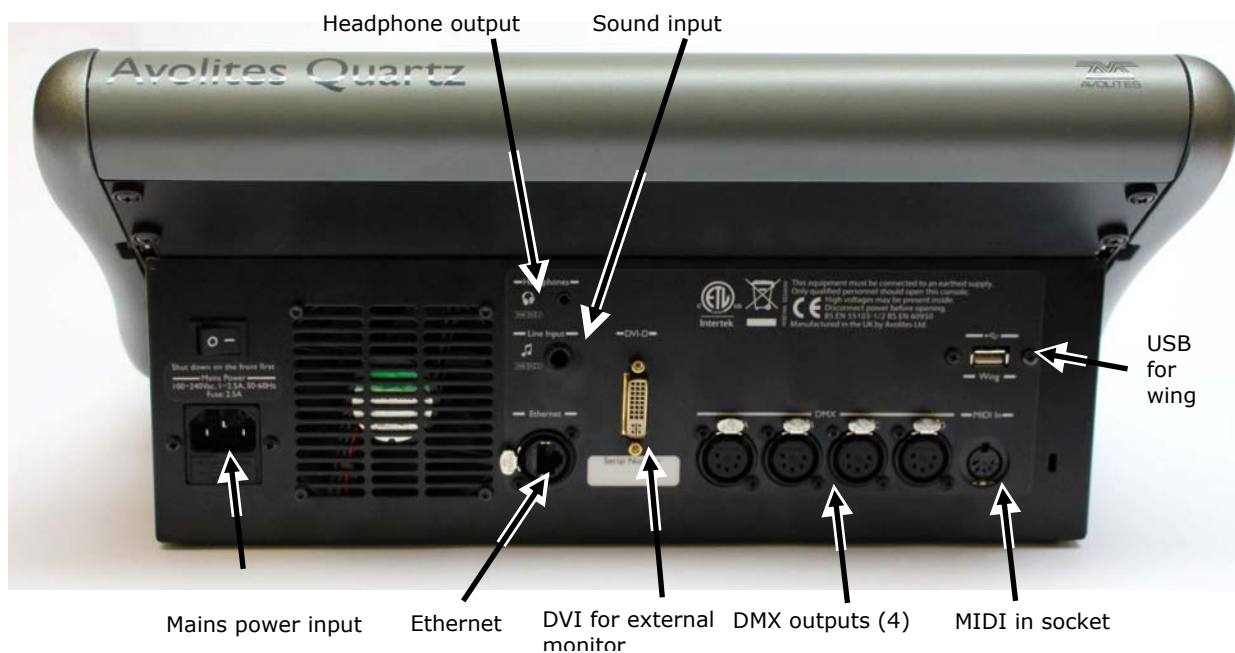

All the connections are on the rear panel. Most are self-explanatory. The power switch on the rear panel is an isolator for the power supply and should not be used to turn the console off. Use the switch on the front panel to turn the console on and off.

-

2.2 Connecting up

2.2.1 Cautions



Radio transmitters may affect the operation of the console and we recommend that they are not placed on, above or behind the console. If you are wearing one it is best placed in a back pocket or behind you when attached to a belt.

2.2.2 Connecting mains power

You can safely connect the Quartz to any voltage from 80 to 260V.

We recommend that you power the console via an external uninterruptible power supply or UPS (available from computer suppliers), otherwise when someone pulls out the wrong plug and kills power to the console you can lose data (up to the last Autosave) and the console may want to check its disk on startup which can cause delays. The UPS will protect you from most power problems and give you chance to shut down the console normally.

2.2.3 Starting up and shutting down

The console runs a Windows-based operating system internally, so you need to make sure it is shut down properly rather than just turning off its power.

Start up the console by pressing and releasing the Power switch at the top right of the console. The console display should come alive. The console takes about 1 min 30 seconds to start up.

Shut down the console by pressing and releasing the Power switch again. The console will perform a controlled shutdown. Wait until the Power light has gone off (about 30 seconds) before you disconnect power from the console.

To carry out a **Forced Shutdown** of the console, if the normal shut down does not work, hold down the power switch for 5 seconds. You will lose any changes to your show since the last save.



If the console has a power switch on the rear, do not use this to switch off the console as this would not close down the software properly and you will lose any changes to your show.

2.2.4 Titan Healthcheck

When the Titan software starts up, it runs a small utility called Titan Healthcheck which checks the file system and the installed firmware and software for anything that might cause you problems. If any problems are found, a warning screen is displayed which offers the option to fix the problems.

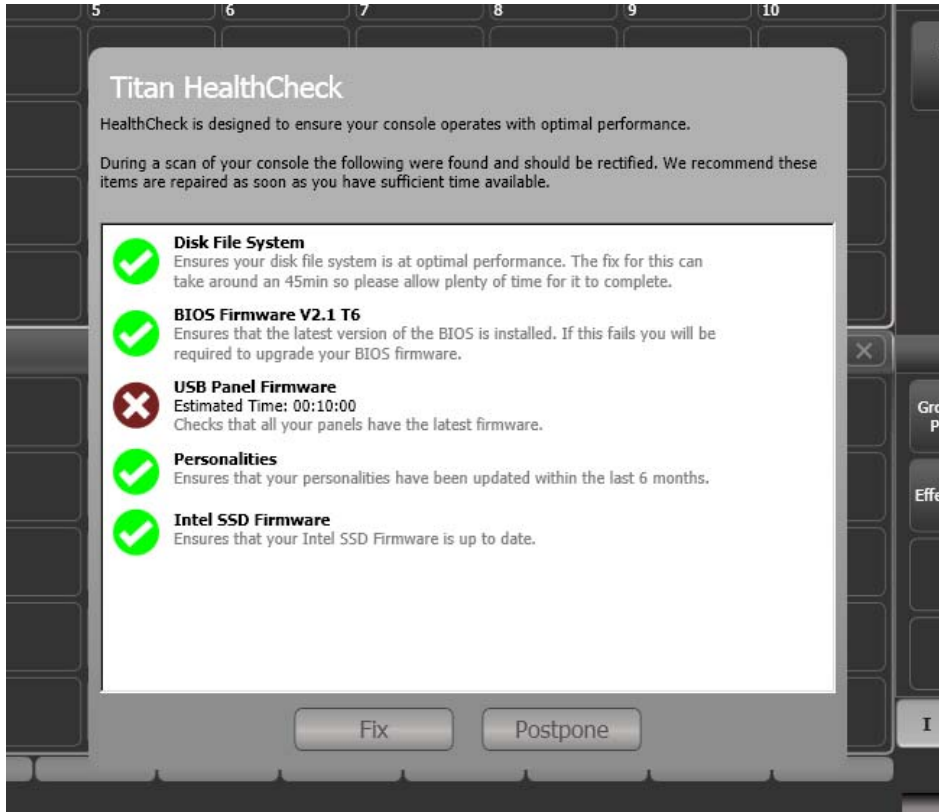

Only run fixes if you have plenty of time as some fixes can take up to an hour to complete.

2.2.5 Connecting DMX lines

The console communicates with lighting fixtures using the DMX512 system. The console itself can output 12 universes of DMX (each 512 control channels). If you need to output more universes, it is recommended to network the console to one or more Avolites TitanNet processing nodes. This off-loads the DMX processing, allowing the console to control up to 64 universes of DMX in total (see section 13.6.1 on page 249 for more details).

The console has 4 DMX outputs on 5-pin XLR for direct connection to fixtures and dimmers, and can send DMX over Ethernet and wireless Ethernet systems to allow connection to remote DMX Ethernet nodes, media servers, and so on.

When you patch a dimmer or fixture you tell the Quartz which of the 12 (or 64 with TitanNet) DMX universes it is on. Each universe can be configured to come out of one or more of the standard DMX outputs on the back of the console, or over an Ethernet protocol (see section 15 on page 263.)

By default, DMX Lines 1-4 are connected to the four XLRs on the console.

The 5-pin XLR sockets on the console are wired like this:

Pin 1	Earth
Pin 2	Data -
Pin 3	Data +
Pin 4	Not used

Pin 5	Not used
-------	----------

Each DMX line should pass through all the fixtures to be connected on that line one after the other and have a DMX terminator fitted at the end (120 ohm resistor between pins 2 and 3). You should not split the DMX lines using passive splitters (Y-splits) as this can corrupt the data.

2.2.6 Connecting console wings

“Wings” are additional control surfaces which can be connected to the console to provide more faders and buttons, and in some cases extra touch screens.

Tiger Touch Wing

The Tiger Touch wing provides 30 additional handles each with an associated legend display. The handles can be used as playbacks or to patch fixtures/dimmers. Each row of 15 faders has its own independent paging control.



The Tiger Touch Wing connects by USB to the main console. It also needs a mains power connection. The Wing has a built in USB hub to provide 2 further USB sockets for a keyboard etc.

The Tiger Touch Wing is designed to fit next to the Tiger Touch console but can also be used with the Pearl Expert, the Quartz and the Sapphire Touch.

Titan Mobile Wing

The Titan Mobile Wing adds 20 additional playback faders and 30 macro/executor buttons to the main console. It connects by a single USB cable to the console.

It is designed to fit next to the Titan Mobile panel, but it can also be used with the Tiger Touch, Quartz, Arena and Sapphire Touch consoles.

If you want to see the legends and function information for the wing controls, you can open the Wing View workspace window.



Sapphire Touch Wing

The Sapphire Touch Wing gives you another touch screen and 30 additional motorised playback faders for the Sapphire Touch console. Two wings may be used with the console, connected to the USB and DVI ports for the left or right external monitor.



2.3 Using the touch screen and monitor

The heart of the Quartz is the touch screen and the extra parameter screen.

2.3.1 Workspace windows

The main area of the screen contains the workspace windows. These contain buttons for selecting fixtures, groups, palettes, playbacks and so on. Information windows such as Playback View and the integrated Visualiser application can also appear as a workspace window.

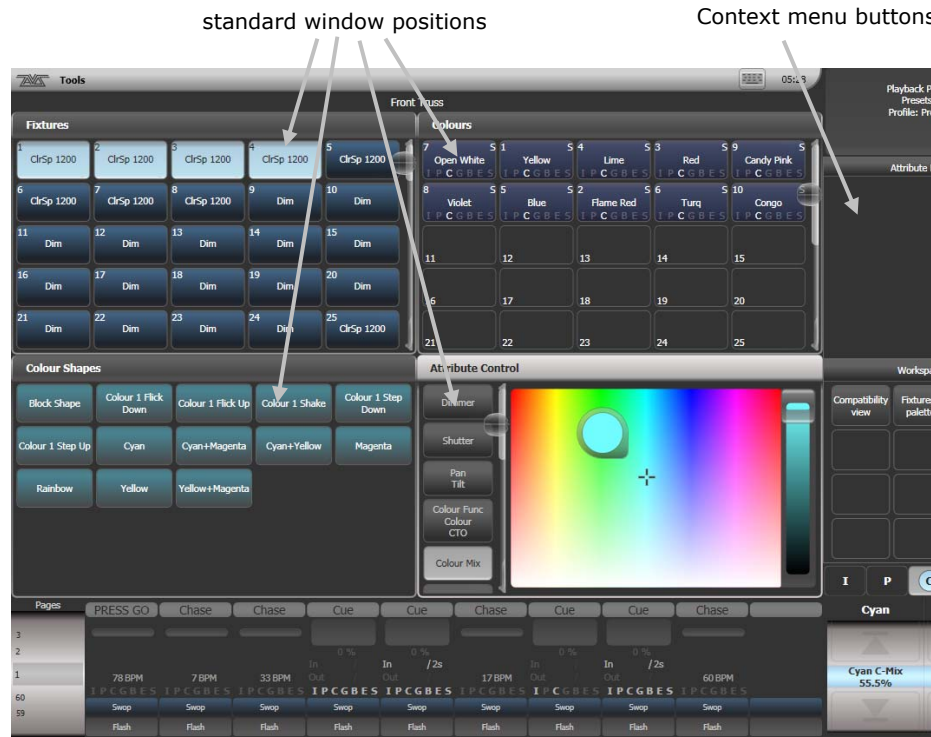

Opening and positioning workspace windows

You select which workspace windows you want to see using the [Open Workspace Window] menu command on the root menu. You can also press the Window Open button to access the [Open Workspace Window] option while in another menu and there are shortcuts to open some windows as listed in the next section.

You can change the positions and sizes of the windows by using the Window Control buttons above the numeric keypad or the Window Options button (cog icon) at the top of each screen. The min/max button swaps the active window between full screen and quarter size. The size/position button moves the active window around the possible positions. You make a window active by clicking/touching its header bar.

You can move the active window to a different monitor by pressing Avo and the Size/Position button, or Window Open then [Window Options] then [Move Screen].

Shortcuts to open workspace windows

Press Window Open then an Attribute Bank button to open the Palette window for that attribute.

Press Window Open then Patch to open the Patch View window.

Press Window Open then a fixture select button to open the Fixture View window showing patch details for that fixture.

Press Window Open then Connect to open the View Cue window.

Press Window Open then Off to open the Active Playbacks window.

Press Window Open then Macro to open the Macro window.

Window setup buttons

At the top right of each window are three or four buttons which access other functions for the window.

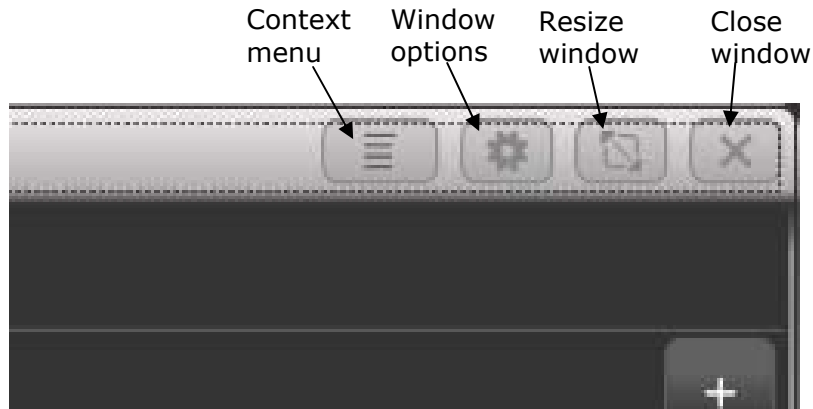

The **Context Menu** button is only shown on Sapphire Touch and Titan One, and gives a drop down menu at the top of the window showing the context menu buttons which relate to the current window.

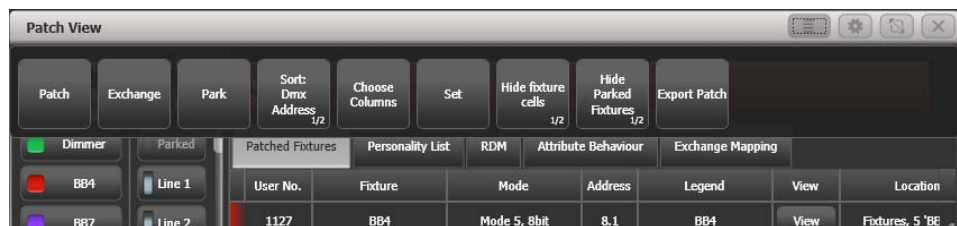

On all other consoles the context menu buttons are automatically shown below the prompt area on the top right of the main screen. The buttons change to match the active window.



The **Window Appearance Options** button (cog icon) lets you select the standard window sizes and positions. Buttons are also shown allowing you to set the button size and the text size of the window. The Appearance options may vary depending on which window it is, the setup of the console and if you have any external monitors.

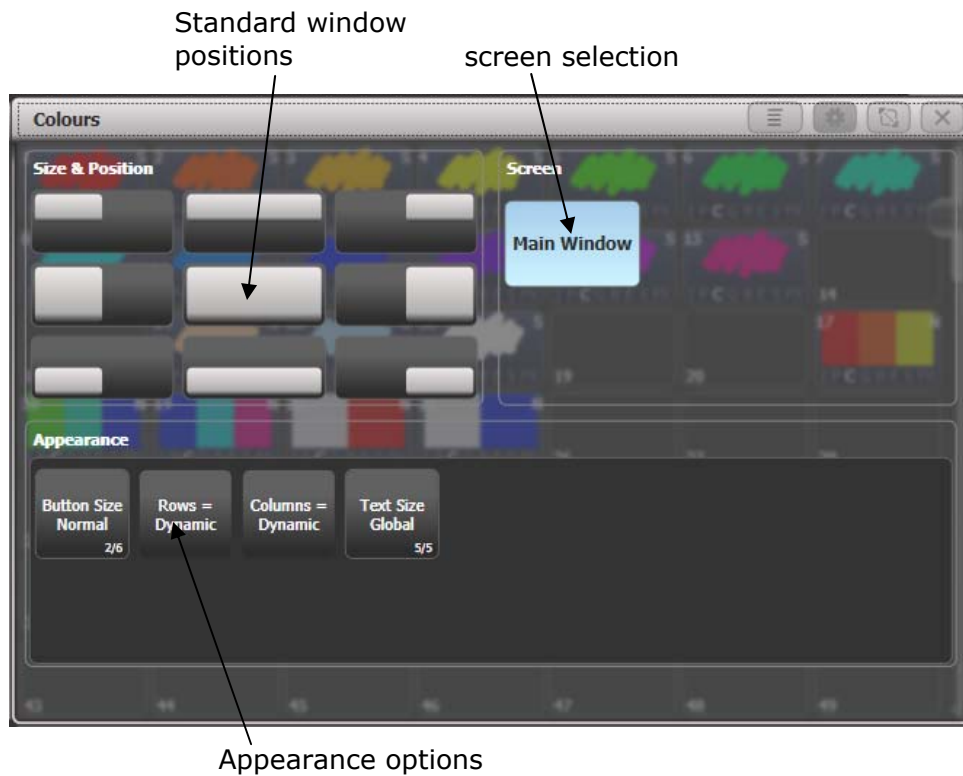

As well as the standard window sizes, you can set custom window sizes and positions using the **Window Layout** button. See section 13.2.2 on page 234 for details.

Saving workspace layout

You can save different workspace layouts to the Workspaces touch buttons (to the left of the menu) by pressing Window Open then [Record Workspace], then touching one of the Workspaces buttons. This allows you to reconfigure the workspace at the touch of a button.

Workspaces are saved with the show.

Setting up and recording workspaces is described in more detail in section 13.1 on page 233.

Quick record

Some windows – Groups, Workspaces, Playbacks, and all the Palette windows - have a Quick Record function. Set up what you want to record, then touch or click an empty button once. The button will light up red with a + sign. At this point you can enter a legend. Touch or click again to store the item.

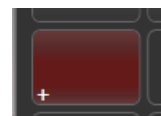

The Quick Record function can be disabled using Key Profiles (see section 13.4.1 on page 242).

Legends and picture legends

All touch buttons can have legends set to remind you what they do. In addition, you can draw picture legends on the buttons. To do this, select [Set Legend] then press [Picture]. A drawing space will open on the touch screen for you to draw the legend. There is also a library of pictures to choose from including popular gobo designs.



Button Halo

You can set a custom coloured halo for fixture, group or palette buttons. This can be really useful for identifying different types of button at a glance. Select the [Halo] option on the Set Legends menu.



If you set a halo on fixture buttons, the halo colour is also used in other windows; fixture buttons can also have an automatic halo to help identify different types of fixture. There is more information on fixture halos in section 3.2.6 on page 60.

Button Layout

Buttons normally resize automatically to suit the screen size and resolution, however sometimes moving shows between different consoles can make the number of rows and columns change, causing buttons to move around. If you have set a particular layout you want to keep (for example positioning fixtures to match the layout on stage), open the Window Appearance menu using the Cog button and set Button Size to [Button Size Set Rows & Columns]. You can then set a fixed layout using the [Rows] and [Columns] buttons.

Touch Keyboard

At the right hand end of the toolbar is the keyboard popup button which will open the touch keyboard.



The touch keyboard can be switched between large and small size using the Max/Min button and you close it using the large X button in the top right hand corner. It can be set to pop up automatically when text input is required, using the Man/Auto button. You can also move it on the screen by touching and dragging the blank area of the keyboard at the top.

The small version of the keyboard (pictured) does not have some of the less frequently used buttons.

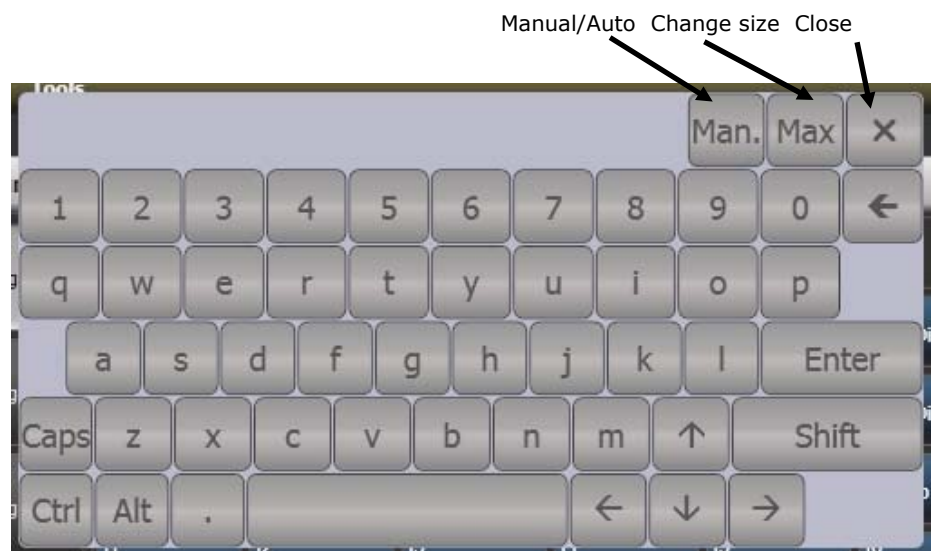

2.3.2 The menu area of the touch screen

The right hand side of the touch screen is used for the operating menu display.

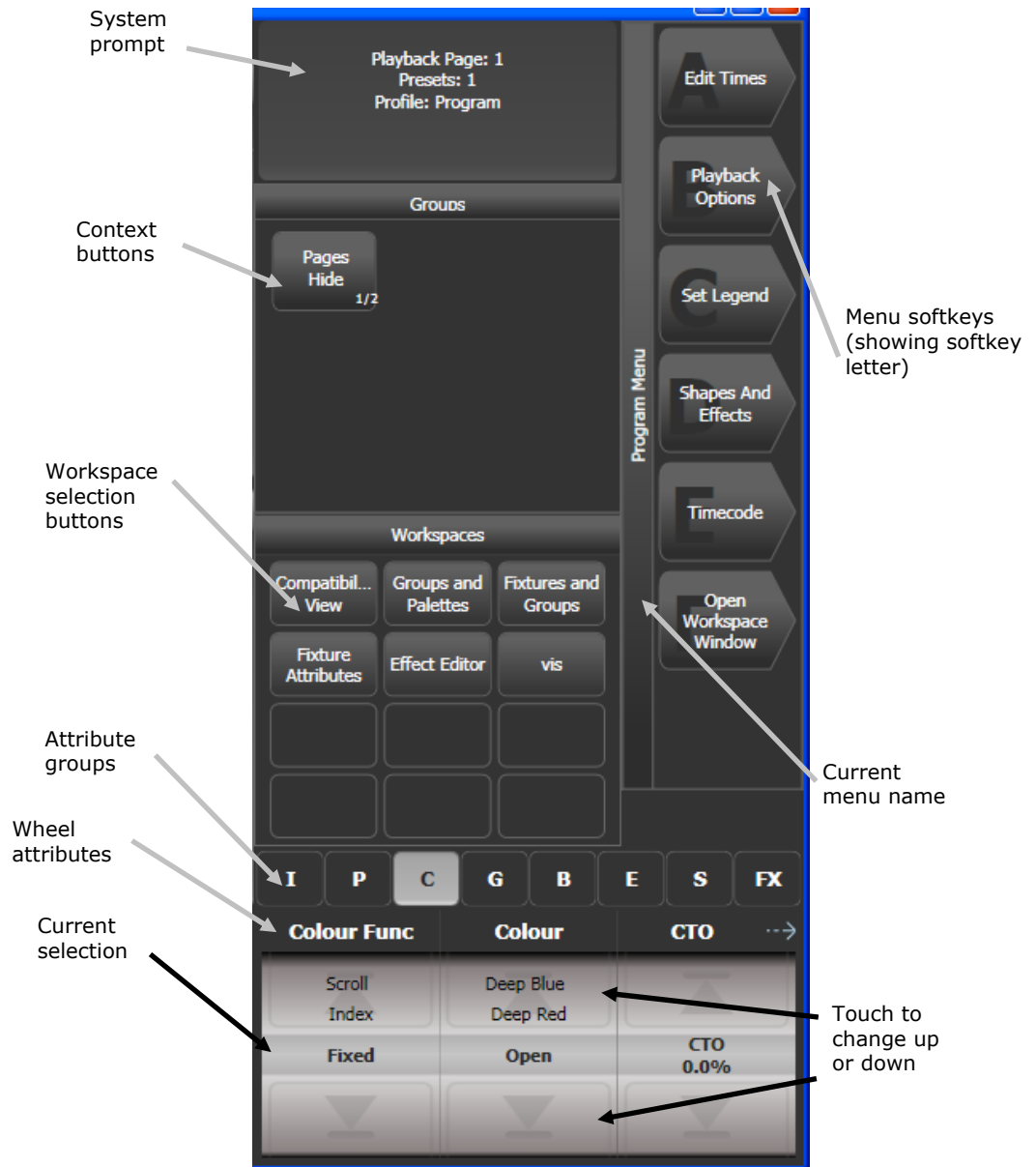

Down the right hand side of the screen, the functions of the A-G menu softkeys are listed. If there are more functions than will fit on one screen, [Previous] and [Next] buttons are provided to page through the functions. You can either press the real button next to the screen or touch the key on screen.

The vertical bar to the left of the softkeys shows you which menu you are currently in. You can 'latch' the menu (so that you don't have to keep reselecting it) by pressing the Menu Latch button. The menu bar turns red when latched.

The area to the left of this shows instructions to the user and information from the console.

At the bottom of the screen, the current function of the wheels is shown on a simulated roller. If fixture attributes are being set, this shows the possible settings which are available on the fixtures. Above the roller image a legend shows which attributes are being controlled by each wheel and the centre of the roller shows the current attribute. Touch the upper or lower segment of the roller to set the attribute to maximum/minimum.

If a chase is being controlled, information about the chase is shown here.

Above this, the screen shows which attribute group (Intensity, Position, Colour, Gobo, Beam, Effect and Special) is selected (grey box) and which are currently modified (blue circle).

The appearance of the softkeys varies to indicate the type of actions available:

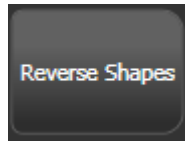

Action button: console will carry out the action shown

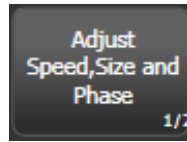

Option button: cycles through a range of options

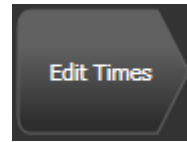

New menu button: jumps to a new menu



Text entry button: press and enter text using the touch keyboard

2.3.3 The toolbar

Across the very top of the screen is the toolbar.



If you click/touch on 'Tools', you will get a menu giving you access to some configuration functions (these options may change slightly depending on the console).

About gives you information about the software version.

Help shows you the online manual.

Control Panel opens a sub-menu allowing changes to monitor settings and to the USB expert console which links the front panel controls to the system. The 'More...' option opens Windows Control Panel allowing you to change the operating system configuration.

Touch Screen Setup (in Control Panel) opens the setup utility which allows you to align touch positions on the screen. See next section.

Usb Expert Console (in Control Panel) sets up the connection between the front panel controls and the software. If you are having problems this can be used to troubleshoot.

Folders opens the file explorer. You might need this when backing up show files or when updating the operating software.

Switch Task allows you to show other programs (may be needed when upgrading software) on the touch screen or move them between screens. Touch the Switch Screen icon to swap the program between different screens. Touch the Centre icon to centre the window on the screen. Touch Close to close the program. The appearance of this window varies depending on the console.

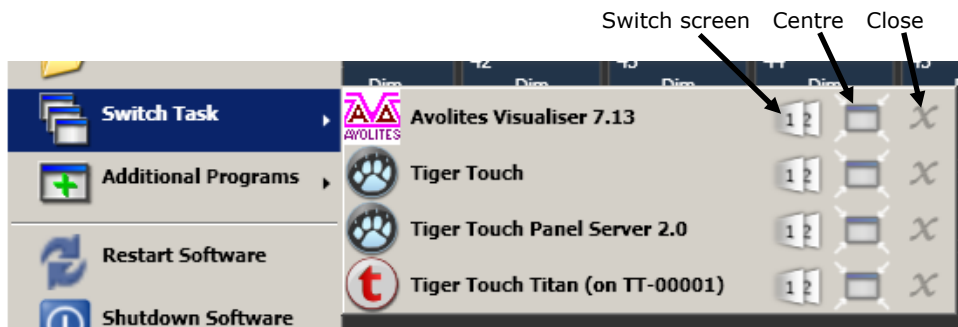

Additional Programs allows you to run some diagnostic programs which might help Avolites Support find problems you're having.

Restart and **Shutdown Software** restarts and closes the Titan software. You would normally only need to use these when upgrading the software.

2.3.4 The Heads-Up Display (HUD)

The HUD window is shown as one of the workspace windows. Most of the HUD information is now shown in other windows, but if you're used to using it you might like to have it displayed.

Fixtures are highlighted in dark blue if in the programmer and in light blue if selected.

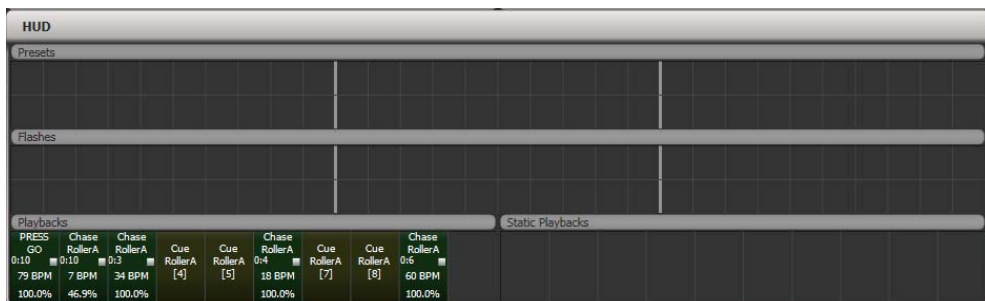

2.3.5 Visualiser



Capture visualiser is integrated into Titan from v10. This replaces the original wireframe visualiser, which is still available using the [Legacy Visualiser] option. .

The visualiser gives you a realistic view of the stage, allowing you to pre-program or make changes to your show at home or in your hotel. It can also be used in Blind mode for programming during a show.

The visualiser is described in detail in chapter 10 on page 205.

2.3.6 Key profiles

The console allows you to change the function of the blue select and grey flash panel buttons. You can also change the way some of the touch keys work. You can save your settings as a Key Profile. Different profiles can be selected for different users or to enhance the operation of the console for a particular use. See section 13.3 on page 240 for details.

2.3.7 Undo/Redo

A short list of recent actions is shown in the prompt area to the left of the menu.

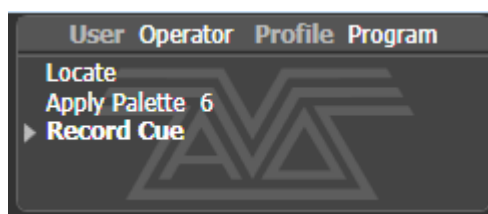

You can undo and redo recent actions (including fixture and cue changes) by touching the prompt area. This will automatically open the Undo History window which shows a more detailed list of actions you can undo.

The current action is shown in red in the Undo window and in bold in the prompt.

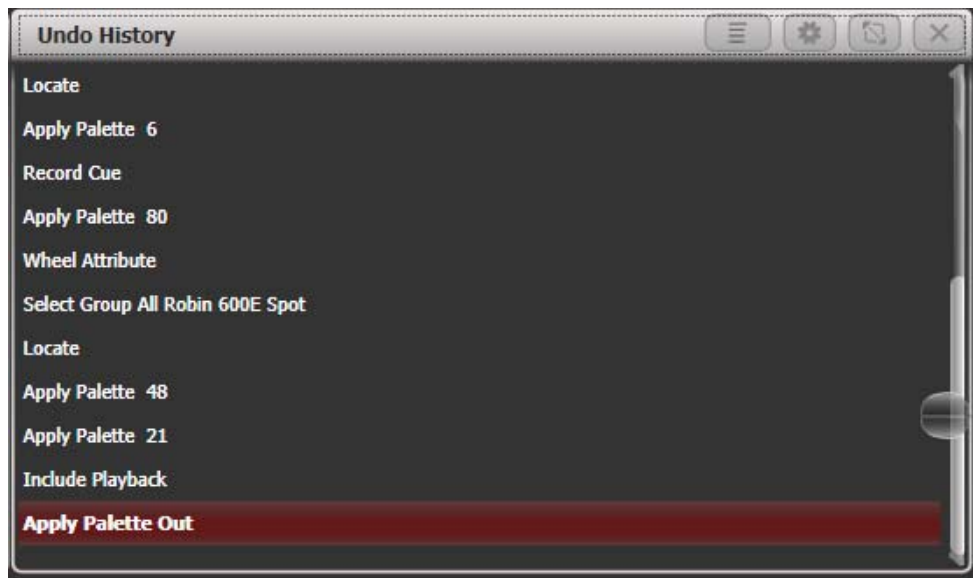

You can touch this window to undo all actions up to the one you touch. Once actions have been undone they are shown greyed out, and can be redone by touching them.

You can also use the Undo and Redo buttons to step through the list.

Some actions cannot be undone which is indicated with the “not allowed” symbol as shown below.

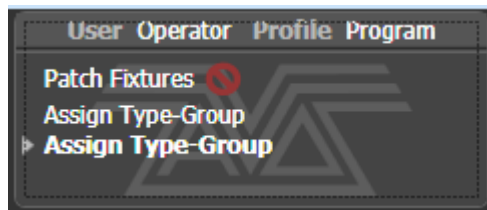

If you are in multi-user mode, the Undo History can show a column for each user with undo points for that user – open the Context menu and select [Show All Users and Consoles]. The default setting is [Show Only Current User].

2.3.8 Key macro buttons

Lighting programming can sometimes require a repeated sequence of button presses. You can record sequences of keypresses and play them back with a single keypress – this is called a macro. The macro can reproduce the timing of your button presses (Real Time mode) or just repeat the sequence of buttons with no timing (Full Speed mode).

Real Time mode is useful when you are using a macro to reproduce a lighting effect, for example a sequence of flash buttons. Full Speed mode is more useful for admin tasks such as changing console mode.

Macros can be stored in the 20 dedicated buttons to the right of the wheels, and there is also a Macro button window which can be shown in the workspace. The macro buttons correspond to the first 20 macros in the window.

To record a macro:

-
- 1> *Press the Macro button (above keypad)*
 - 2> *Select [Full Speed] or [Real Time].*
 - 3> *Press [Record]*
 - 4> *Press an empty Macro button on the panel, or an empty button in the Macro window on the screen. Recording starts. The Insert/Macro button flashes during recording.*
 - 5> *Press the sequence of buttons you want to record.*
 - 6> *Press Record Macro to finish recording.*
-

To play back the macro, just press or touch the button where you recorded the macro. The macro will repeat all your button presses, with correct timings if you selected Real Time mode.

2.3.9 Locking the console

You can place a simple lock the console controls to prevent people fiddling with it while you're not looking. Hold down Avo and press [Lock], then type a password (numbers or letters). To unlock, enter the password again, or restarting the console will also unlock it. This is not a high-security lock, it's just to prevent idiots messing with it.

While the console is locked, all functions are disabled except the DMX outputs and currently running playbacks.

2.3.10 Keyboard shortcuts

Many features of the console can be controlled by shortcuts on the keyboard. These are especially useful when using Titan Mobile or Titan Simulator.

The Titan application "captures" the keyboard on start up, meaning that if you try to use other applications at the same time they will not receive keypresses. Pressing Break on the keyboard releases the keyboard for other applications but disables all text entry for Titan including the shortcut keys; changing menus will reconnect the keyboard to Titan.

Shortcuts are shown on the next page.

F1	Move to other screen	Ctrl X	Cut text
F2	Activate window	Ctrl C	Copy text
F3	Minimise/Maximise	Ctrl V	Paste text
Shift F3	Next window	Ctrl A	Select all text
F4	Size/Position	Ctrl Z	Undo
Shift F4	Move to other screen	Ctrl Y	Redo
F5	Close window	Alt C	Clear
Shift F5	Close all windows	Alt R	Record menu
F6	Open Playbacks window	Alt A	Toggle Avo (shift) menu
F7	Open Fixtures window	Alt L	Locate
F8	Open Groups window	Alt P	Patch
F9	Open Colours window	Alt ↑ D	Disk menu
F10	Open Positions window	Alt ↑ S	System mode
F11	Gobos/Beams window	Alt V	Open/View menu
F12	Open Channel Grid	Alt G	Go
Esc	Exit menu	Alt D	Delete
Enter	Enter	Alt ↑ C	Copy
Alt 1	Softkey A	Alt M	Move
Alt 2	Softkey B	Alt U	Unfold
Alt 3	Softkey C	Alt I	Include
Alt 4	Softkey D	Alt ↑ R	Release
Alt 5	Softkey E	Alt S	Shape
Alt 6	Softkey F	Alt T	Fixture Tools/ML Menu
Alt 7	Softkey G	Alt B	Blind
Alt ↑ F	Fixture	Alt O	Off
Alt ↑ P	Palette	Alt F	Fan
Alt ↑ M	Macro	Alt ↑ O	Attribute options
Alt ↑ G	Group	Alt ↑ L	Latch menu
/ (num)	Thro	Alt ←	Previous fixture
* (num)	@	Alt →	Next fixture
- (num)	Not	Alt ↑	All
+ (num)	And	Alt ↓	Highlight

↑ means shift

(num) means on the numeric keypad

2.4 Multi-user operation

You can connect multiple consoles together to work together on a show. You can also have multiple user setups on a show on a single console to allow different layouts, for example for a support band LD.

2.4.1 Users

Each show can have multiple users. Each user has their own user settings, key profiles and handle layout (known as a *handle world*). This provides a quick way to switch between preferred user settings and handle layouts, for example at a festival or other event where there are a number of operators.

Users are stored in the showfile and the currently selected user is restored when loading a show. The default user is called "Operator" and the prompt area in the display shows the current user name and selected key profile.

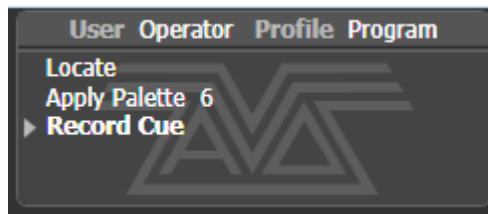

To change or create users, go to the Users menu.

-
- 1> Press the Disk button.
 - 2> Press [Users].
 - 3> To switch to a different user, press [Change Current User] and select a new user from the list (the current user is highlighted).
 - 4> To create a new user, press [Add a User], enter a name for the new user and press [OK].
 - 5> You can also quickly change user from the root menu by holding Avo shift and pressing [User ...]
-

- If multiple consoles are connected in a collaborative session, any user added to one of the consoles will be available on any of the other consoles.

2.4.2 Handle Worlds

Each show can have multiple Handle Worlds, each having its own layout of handles. This allows each user to have their own layout of cues, palettes and chases which can be easily switched, for example when a support band and headline band are using the same console, or when multiple programmers are working collaboratively on a number of consoles.

When a new user is selected, the handle world they were using is also loaded.

All handle worlds are stored within the showfile, the default handle world is called "Mapping World 1".

Handle Worlds are managed from the Disk menu.

-
- 1> Press the Disk button.
 - 2> Press [Handle Worlds].

- 3> To switch to a different handle world, press [Select Handle World] and select a new handle world from the list (the current one is highlighted).
- 4> To create a new handle world, press [Add Handle World], enter a name for the new world and press [OK].
- 5> [Delete Handle World] will delete the world, any handles used only in that world will become unassigned (and can be retrieved using the Show Library if needed).

- Items created in a different handle world can be accessed using the Show Library workspace and assigned to handles in the current handle world.
- The [Follow World Page Change] option sets whether the handle page will change if a user using the same handle world on another console changes the page.

2.4.3 Linking to other TitanNet sessions

If multiple Titan consoles are connected in the same network you can choose to connect them as multi-user, tracking backup, or both. This is also how you connect TitanNet processors to expand DMX outputs.

For details of how to connect Titan consoles together on a network, see section 15 on page 263.

- 1> Press the Disk button.
- 2> Press [TitanNet Sessions].
- 3> [Sessions View] opens a window that shows you how your console is connected to others, and what other TitanNet sessions are available. You can touch on another console in the window and click [Connect] to start a connection, or use the other buttons to leave a session.
- 4> Or select [Backup], [Multi-User] or [Backup & Multi-User] to show a list of sessions which you can connect to. Click on the session to start the connection.

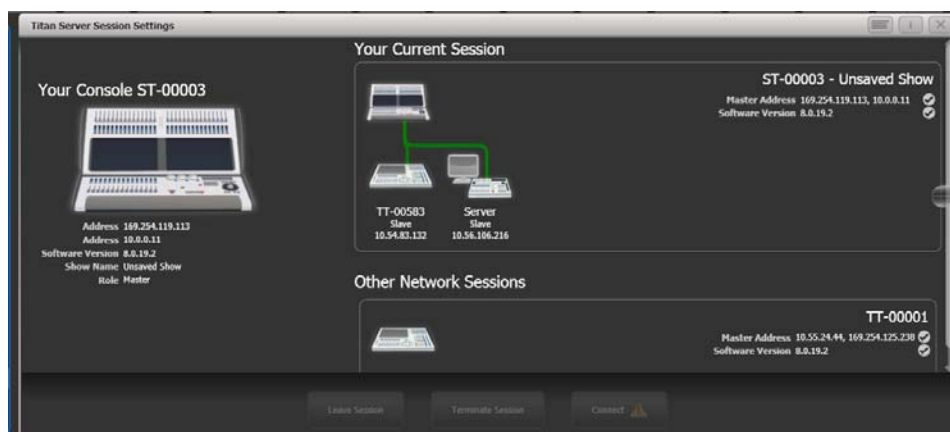

- A green line shows a good connection, a dotted red line shows a problem with a connection. Unavailable consoles are shown with a red background.

Initially all consoles are "Master" consoles. If you connect to a session on another console as multi-user you become a "Slave" on that console. The show on the Master is transferred across the network to the Slave. On the Slave you can choose to save the show locally or to save changes back to the Master console.

The toolbar will show details of the master/slave status. Console legends can be changed in the System menu using the [Console Legend] option.



Consoles connected in a multi-user session work on the same show. If the same handle worlds are selected then an action on one console is mirrored across them all, for example firing a cue on the slave console will also fire the cue on the master. If the master has motorised faders, the fader will move; if not, fader levels must match before they can take over. If different handle worlds are selected, users can work independently on their own pool of handles.

In all situations the master console outputs DMX and channels in a remote programmer are shown with a blue dot on the touch wheel views. If two or more consoles are editing the same fixture, the last console to change any attribute will take over control of the fixture.

Slaves can leave a session using the [Leave Session] button in the Sessions View or in the TitanNet menu. The console will restore the local show it had loaded prior to joining. Master consoles have the option to [Terminate Session].

If a console is running as backup, it has options to [Takeover], [Sync now] and [Leave Session]. If [Takeover] is selected, the console will immediately become the master and take over DMX output with the chosen user and handle worlds selected. The console which was master will go into a dormant state with DMX disabled.

- Consoles must be running Titan v8 or above to join a multi-user or backup session with another Titan v8 console.
- Tracking backup operation is also described in section 11.6.2 on page 223.

2.5 Titan Simulator

Need to pre-program or tweak your show before you get to the venue? No problem, just run the Titan Simulator on your PC. You can then load your show and simulate any of the Titan consoles, using an on-screen "virtual panel".

You can also use the Titan One software without the Titan One dongle within the simulator for pre-programming.



2.5.1 Installing Titan Simulator

You will need a Windows user account with Administrator privileges to install or run Titan Simulator.



From v7, Windows XP and Vista are no longer supported by Titan software. Your PC must be running Windows 7, Windows 8 or Windows 10.

Capture visualiser requires a capable graphics card. If you have problems, ensure you have installed the latest drivers from the graphics card manufacturer.

Simply download and run the installer from the Avolites Download website. The first time you run Simulator you will need to license the software with the Avolites website. For this you will need an account set up on the Download site, which you should go and create now if you don't already have one.

To license the software, start Titan Simulator and choose Internet Activation (the software will ask you for your Avolites Download user name and password and automatically retrieve your license), or Manual Activation (you have to copy and paste the Computer Key into the form on the Titan Simulator webpage).

Once licensed Titan Simulator will run in 'Offline' mode which is shown towards the top right of the screen. In Offline mode the software will function as normal including Visualiser and Art-Net outputs. However periodically random DMX values will be sent down all DMX outputs, please wait for this to stop before continuing programming.

2.5.2 Running Titan Simulator

When you start the simulator you need to select which console you are simulating. The simulator will then open a Virtual Panel, which replicates the controls of your chosen console, and monitor windows for each of the monitor outputs.



The Tiger Touch and Sapphire Touch simulators show the touch screen display separately from the Virtual Panel.

The Virtual Panel works exactly the same as the real panel; to hold a button down so you can press a second button, right click it using the mouse.

2.5.3 Using Virtual Panel with a console

As well as its use with the simulator, you can also run the Virtual Panel on a console. This could be handy to keep things going if you are suffering hardware problems with the real console controls.

To show the Virtual Panel, click the Tools menu on the toolbar, then select Other Programs, then Virtual Panel. The Virtual Panel controls will work in parallel with the real controls.

2.6 Loading and saving shows

You can save any number of different shows on a USB drive or the console's internal hard disk. The console will also autosave the show periodically.



Shows created on the Quartz can be loaded into any other Avolites Titan console, but not to older non-Titan consoles as the showfile format is different. Showfiles from newer versions of Titan may not load correctly into consoles with older versions of Titan.

Although your show is safe on the console's internal hard disk, it's a good idea to also save it to a USB pen drive which you can take with you in case something bad happens to the console or if you want to transfer a show to a different console.

2.6.1 Saving the show

You can save your show at any time either with its current name or with a new name. If you save your show with its current name, a new version of the show will be created. This allows you to go back to previous versions of your show if needed.

To save your current show:

-
- 1> Press the Disk button.
 - 2> Press [Save Show].
 - 3> If you have a USB drive connected, use the softkeys to select whether to save on [Removable Disk] or [Internal hard drive].
 - 4> If this is a new show, enter a name for the show on the keyboard. If this is a new version of an existing show you can enter a tag to help identify the version, which will be shown on the Show Browser screen when you load shows.
 - 5> Press Enter or [Save] (or [Overwrite] if the show already exists). The show will be saved.
 - 6> Press Exit or [OK] to leave Disk mode.
-

- To save the show under a different name, use the [Save As] softkey.
- Pressing the Disk button twice will force the console to save an Autosave version of the file. Autosaves are stored in the same folder as the normal show file.
- A new version of the file will be saved even if you enter the same tag as previously used.

If you save to hard drive, shows are saved in the folder 'D:\Show Files', unless you change this in the User Settings. When using the Titan Simulator or Titan One, shows are saved to 'Documents\Titan\Show Files'.

2.6.2 Loading a show

The console will automatically reload the last show when it is turned on.

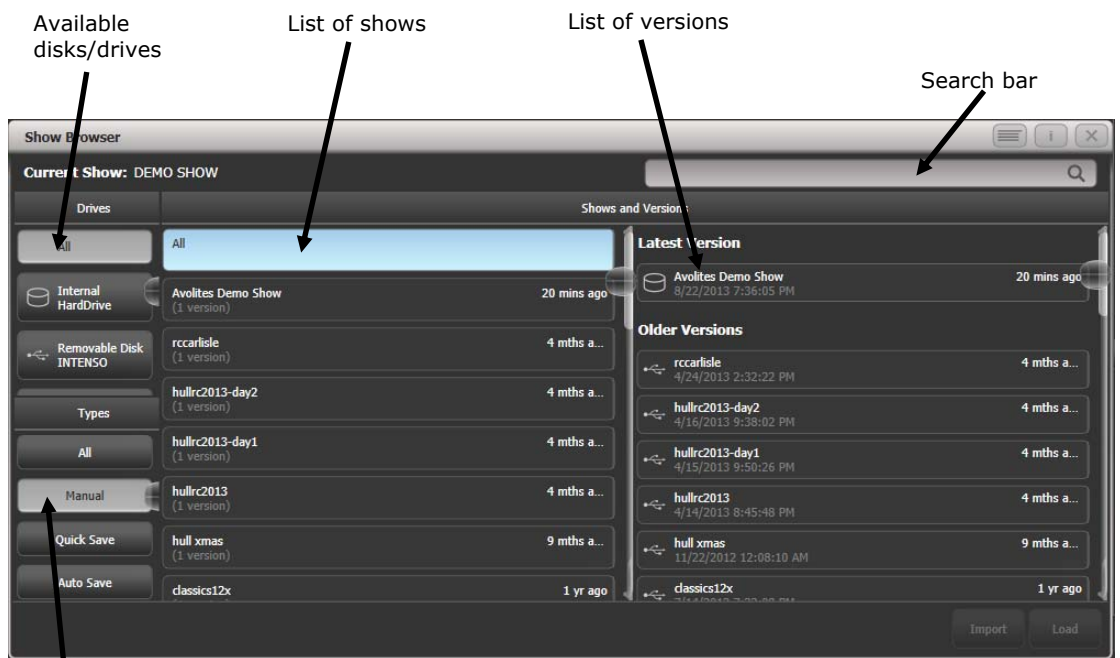

Filter list of shows

Press the Disk button then [Load Show] to load in a new show. The Show Browser window will appear.

On the top left you can select which drive is used, or show files on all drives. On the bottom left you can filter the list of shows to see all shows, or just manual saves, quick saves or autosave files. On the right you can see different versions of the showfile; this allows you to reload an earlier version if you need to.

You can also load shows from the softkeys:

- 1> Press the Disk button.
- 2> Press [Load Show].
- 3> If you have a USB drive connected, select which drive you want to load from.
- 4> Available shows are listed on the softkeys; press the key to load the show (the F and G keys show more pages). If you type the

first few letters of the show name on the touch keyboard, the list will only include shows starting with those letters, which can make it easier to locate the show you want.

- 5> If there are multiple versions of the show stored on the disk, select the one you want.
- 6> Press Load Show. The console will show a loading screen as the different elements of the show load.
- 7> When the show has loaded the normal operating screen will reappear.

When loading a show you have the option to keep the existing DMX settings of the console, or to load the settings stored in the showfile. The DMX settings determine how the XLR sockets on the back of the console are used and how DMX is sent over the network using TitanNet.

You can save any number of different shows on the Quartz 's internal hard disk.

2.6.3 Importing parts of other shows

If you are doing a show which is similar to a previous one, you might want to import parts of the previous showfile, for example you might want the palettes for some Robe Robins from another show, but not the other fixtures. This is where the Import Show function comes in handy.

For Import Show to work, you need to map fixtures from your imported file to fixtures in the current show so that Titan knows where to import the programming to.

The screenshot shows the 'Show Library' window with the following components and annotations:

- Button for imported show:** Points to the 'Mapper' button in the top left.
- Import new show:** Points to the '+' icon in the top right.
- Filter fixtures in current show:** Points to the 'All Fixtures' dropdown in the left sidebar.
- Arrow shows mapped fixture:** Points to the left-pointing arrow between the 'Current Fixtures' and 'Mapped Fixture' columns.
- Fixtures in imported show:** Points to the grid of fixture palettes on the right.
- Filter fixture list in imported show:** Points to the 'All Fixtures' dropdown in the right sidebar.

Current Fixtures	Usr #	Address	Legend	Usr #	Mapped Fixture
All Fixtures	1	1.1	ColSp70EAT	1	ColorSpot 700E AT
Dimmer	2	1.37	ColSp70EAT		
ColorSpot 700E AT	3	1.73	ColSp70EAT		
ColorWash 575 AT Zoom	4	1.109	ColSp70EAT		
Palco 5	5	1.145	ColW575Zm	10	olorWash 575 AT Zoor
Wash 575 XT	6	1.401	ColW575Zm		
	7	1.177	Wash 575XT		
	8	1.193	Wash 575XT		
	9	1.209	Wash 575XT		
	10	1.225	ColW575Zm		
	11	1.420	ColW575Zm		
	12	1.257	Palco 5		

You can then select items from the imported show and store them onto workspace or panel buttons in your current show.

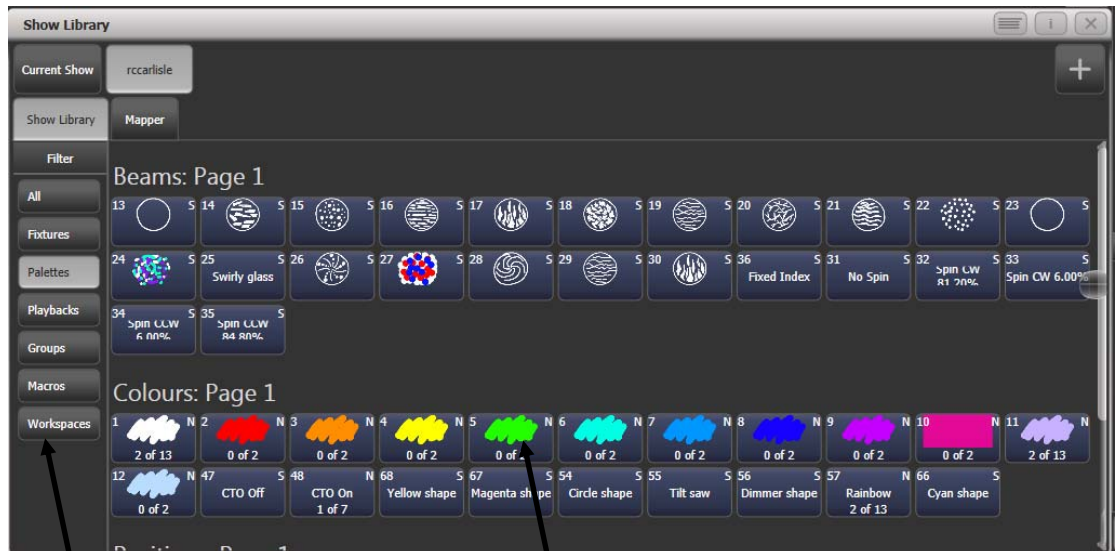

Filter display of
items in show

The items which
can be imported

- 1> Press the Disk button.
- 2> Press [Import Show] (The plus button at the top right of the Show Library window also opens this menu).
- 3> The Show Browser window opens. Select the show you want to import from and press [Load Show].
- 4> The Show Library window will now open. Your current show and the imported show will appear as buttons at the top of the show browser. You can import items from more than one show at once by repeating steps 1-3.
- 5> Click on the Mapper tab, and select your imported show.
- 6> Select a fixture in your imported show, then click the arrow beside the fixture it maps to in the current show. To remove a mapping, click the [Clear Fixture Mapping] context button. You can select multiple target fixtures by dragging a box over the fixtures, or click on the source fixture again and map to another target.
- 7> When you have mapped all fixtures you want to import data from, click on the Show Library tab.
- 8> Select the items you want to import (single or multiple). Use the buttons on the left to select Palettes, Groups etc.
- 9> Select handle(s) where you want to store the imported items.
- 10> When you have imported all the items you want, press Exit.

- You can filter fixture types to make the mapping easier using the buttons on the left and right sides of the show browser.
- You can directly import shows without using the Disk menu by clicking the Plus button at the top right of the Show Browser.
- There is more information about the Show Library window in section 13.3 on page 240.

2.6.4 Autosave

The console will automatically save your show to its internal hard disk when you shut it down. It will also autosave the show every 30 minutes in case the console loses power.

You can disable Autosave or alter the time between saves using option [Auto Save] on the Disk menu (selected using the blue Disk button). You can reload Autosave files using the Show Browser.



We recommend that you have autosave enabled while programming in case the power fails, but disable it while running a show as it can cause the console to pause slightly at inconvenient moments.

2.6.5 Backing up existing show files to USB pen drive

If you just want to save a copy of your current show, you can use the normal save function to save it to the USB drive instead of the hard drive.

To copy an existing show file on the hard disk to a USB drive, first ensure your current show is saved, then use the Disk functions to load the existing show from hard disk, then save it to the USB drive. Alternatively you can use the Folders command on the Tools menu.

2.7 Clearing the console

When you start a new show on the Quartz it is usually a good idea to clear the console. All programming and patching is deleted, but user options are not changed.

-
- 1> Press the Disk button.
 - 2> Press [New Show].
 - 3> Press [OK] to confirm.
 - 4> Press Exit to leave Disk mode.
-

- When starting a new show you have the option to keep existing DMX settings. This preserves the DMX/TitanNet configuration of the console which determines how the XLR sockets on the back of the console are used and how DMX is sent over the network.
- There is also an option [Wipe] in the System menu (when the console is in System mode) which has the same function, and is located in the same place as on the older "classic" Avolites software.

2.8 Creating reports

When preparing a show it is often useful to create a report of how the show is patched or programmed on the console, for example to give to a crew when pre-rigging fixtures, or just for your records.



Showname: BELLOWHEAD NOV 2012 Preprog
 Date: 05/04/13-16:30
 Software Version: PREVIEW
 Console Name: W174

Console Type: Titan Mobile

Patch View

User no.	Fixture	Mode	Address	Legend	Location	Pan Invert	Tilt Invert	Iris Invert	P/T Swapped
1	Robin 100 LEDBeam	Mode 1, 35 DMX	1.1	R100 LED B	Fixtures, 0.000	No	No	No	No
1.1	Robin 100 LEDBeam	1x RGBW cell, 8 DMX	1.7	Cell 1	, 0.000	No	No	No	No
1.2	Robin 100 LEDBeam	1x RGBW cell, 8 DMX	1.15	Cell 2	, 0.000	No	No	No	No
1.3	Robin 100 LEDBeam	1x RGBW cell, 8 DMX	1.23	Cell 3	, 0.000	No	No	No	No
2	Robin 100 LEDBeam	Mode 1, 35 DMX	1.36	R100 LED B	Fixtures, 0.001	No	No	No	No
2.1	Robin 100 LEDBeam	1x RGBW cell, 8 DMX	1.42	Cell 1	, 0.000	No	No	No	No
2.2	Robin 100 LEDBeam	1x RGBW cell, 8 DMX	1.50	Cell 2	, 0.000	No	No	No	No
2.3	Robin 100 LEDBeam	1x RGBW cell, 8 DMX	1.58	Cell 3	, 0.000	No	No	No	No
3	Robin 100 LEDBeam	Mode 1, 35 DMX	1.71	R100 LED B	Fixtures, 0.002	No	No	No	No
3.1	Robin 100 LEDBeam	1x RGBW cell, 8 DMX	1.77	Cell 1	, 0.000	No	No	No	No
3.2	Robin 100 LEDBeam	1x RGBW cell, 8 DMX	1.85	Cell 2	, 0.000	No	No	No	No

Reports can be created in HTML, PDF, CSV or XML formats for the following:

- Fixtures
- Memory (Cues)
- Chases
- Cue Lists
- Palettes
- Groups

To generate reports:

-
- 1> *Press the Disk button.*
 - 2> *Press [Reports].*
 - 3> *Select the item(s) you want to include in the report*
 - 4> *Select the format in which you want to output the report*
 - 5> *Select the drive where you want to save the report*
-

Reports are output to the Documents/Titan/Reports folder. When the report is complete, Titan will open the folder where the report is stored so you can see where it went.

3. Patching

Patching is the process where you tell the Quartz

- What type of lighting units you have connected to it
- What DMX addresses they are operating at
- Which DMX line (universe) each unit is connected to (there are 64 lines, but the console itself can only output 12; further lines can be controlled using networked DMX processors over TitanNet)
- Which buttons on the console you want to use to access them (either physical buttons or touch buttons)
- Particular option settings for each fixture.



Before you start rigging, you can use the console to work out the DMX addresses for the fixtures in your rig. Patch them on the console (or simulator), then press Window Open, Patch to show the Patch View window. This will use the DMX channels as efficiently as possible without leaving any gaps.

If your fixtures are RDM equipped, the console can patch itself from the rig, see section 3.1.6 on page 55.

By default in a new show, DMX Lines 1-4 are connected to the four XLRs on the console. If you want to change this or use other lines, go to the DMX Settings window in System mode – see section 13.1.6 on page 234 .



If nothing is happening to the lights when you make changes on the console it is worth checking the DMX Settings window to make sure the DMX lines are allocated to outputs.

3.1 Patching new fixtures or dimmers

3.1.1 Fixture select buttons and handles

To control intelligent fixtures or dimmer channels, they must each be patched to a button (sometimes referred to as a “handle”). You can patch onto touch buttons in the Fixtures window, to a fader handle or to a Macro/Executor button. If the handle you patch to has a fader, the fader will control intensity.

presets

If the Fixtures window is not shown, press Window Open then [Show workspace window] then [Fixtures].



Fixture buttons can be shown either in pages with Page buttons, or you can use the scroll bar on the right to show different pages. Use the [Pages Show/Hide] button on the right of the screen to select between page buttons and scrolling mode. You can change the fixture page at any time.

You can allocate fixtures and dimmers to Groups, which allows you to quickly select a set of fixtures with one button. Groups are described in the next chapter.

Once you have patched fixtures or dimmers, the Patch View screen shows you an overview of what is patched where and lets you edit the patch. See section 3.2.1 on page 56.

3.1.2 Patching dimmers

Each fixture button can control single or multiple dimmer channels. You allocate a button using the Patch menu (described below) or the Patch View window (see section 3.2.1).

- 1> Press Patch (one of the), then [Dimmers].
- 2> [DMX Line=] shows you which of the DMX output lines you are patching onto. Enter a new number to change the line. [Address =] shows the DMX address about to be patched. You can change this by typing in the new address on the numeric keypad and pressing Enter.

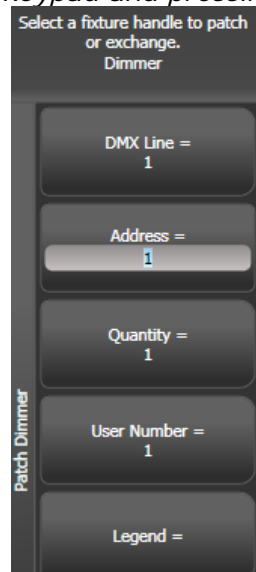

- 3> To patch a single dimmer, press a Fixture touch button, a Macro/Executor button or the blue Select button of a fader

handle. To patch a sequence of dimmers each to its own button, press [Quantity] and set the number of dimmers then press the first select button. Alternatively, run your finger or draw a selection box round the touch buttons, or for physical buttons hold down the first button in the range and press the last button in the range. The range of dimmers will be patched to sequential DMX addresses.

- 4> *A fixture button turns dark blue and shows fixture details when it is patched. If you patch to a fader handle the select button will light up dimly.*
- 5> *Repeat from step 2 for other dimmers.*

-
- When setting the DMX address using [Address=], you can set the DMX line (universe) as well by entering {line}.{DMX}, for example 2.56 will set DMX address 56 on DMX line 2.
 - To see how DMX channels are patched, press Window Open (next to the numeric keypad) then Patch to show the Patch View window.
 - [User Number = xx] allows you to set a user-defined number for each dimmer or fixture patched, to help you identify them later. You can also edit the User Number from the Repatch Fixture menu.
 - You can patch multiple dimmer channels to a single handle. This can be useful if, for example, you want to control all the lights for one area together. To do this, just press the same Fixture Select button again when patching the new dimmer channel. You can tell the dimmer channel has patched OK because the DMX address will increase by 1.
 - If you need to remove a dimmer from multiple dimmers on a single handle without losing programming, make a copy of the handle then repatch the copy to the individual dimmer address.

3.1.3 Patching moving light fixtures

Moving light fixtures are more complicated to patch than dimmers because they have more attributes to control, such as pan, tilt and colour, whereas a dimmer channel just has intensity.

Avolites consoles use a "personality" system to control fixtures. This means you don't have to know how each fixture works, you just tell the Quartz what you want to do and it will send the right control commands. The console has built-in personalities for most types of fixture, which tell it what attributes are available and how to control them. If the console does not have the personality for your fixture, you can download further personalities from the Avolites website, create your own using the Personality Builder application installed on the console, or Avolites can create one for you. See section 14 on page 259 for details of how to find personalities.

You can patch either using the Patch menu (described below) or the Patch View window (see section 3.2.1).

-
- 1> *Press Patch (one of the white function buttons above the numeric keypad).*
 - 2> *Press [Fixtures].*



- 3> *Select the correct fixture manufacturer from the softkeys ([Previous] and [Next] page through the list of manufacturers). Or use Quick Search and type the first few letters of the manufacturer's name on the keyboard to find the one you want.*
- 4> *Select correct fixture from the softkeys (F and G show other pages). You can use Quick Search here as well.*
- 5> *Select the correct fixture operating mode from the softkeys.*
- 6> *[Address =] shows the first free DMX address. Type the new address on the numeric keypad if you want a different one. [DMX line=xx] lets you patch to a different DMX line, or you can enter the address as [line].[address], e.g. 2.45 would set address 45 on line 2.*

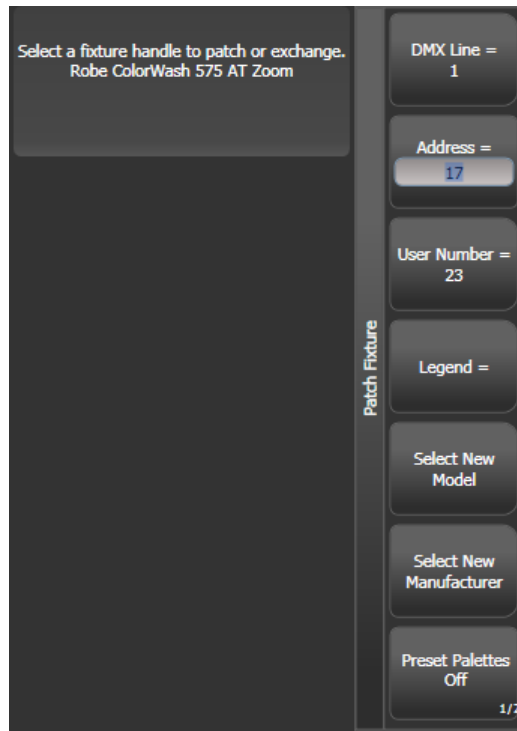

- 7> Patch the fixture by pressing a Fixture touch button, a Macro/Executor button or the blue Select button of a fader handle.
- 8> A fixture touch button turns dark blue and shows fixture details when it is patched. If you patch to a fader handle the select button will light up dimly.
- 9> Repeat from 7 to patch more of the same fixture type. The DMX address automatically updates so you can just keep patching by pressing Select buttons.

- To patch multiples of the same fixture, use the [Quantity] option. Or you can run your finger or draw a selection box round the touch buttons, or for physical buttons hold down the first button in the range and press the last button in the range. The fixtures will be patched to sequential blocks of DMX addresses.
- [Options], [Offset] allows you to leave gaps in the DMX channels between fixtures when patching multiple fixtures, which is useful if you are planning a show which may involve exchanging fixtures. The Offset number is the size of the block which will be allocated to the fixture, for example if you want to allow 32 channels for each fixture you would set Offset to 32.
- You cannot patch more than one fixture onto a handle. If the handle is already used, the patch will fail.
- If you are patching a fixture which uses a separate dimmer channel, such as a VL5, you can patch the dimmer channel onto the same handle as the moving light part of the fixture so you can control it all together. This is called a Pending Dimmer (in the Patch View window this is indicated with a flash symbol behind the user number).
- [Options], [Preset Palettes] sets whether the console will create default colour, gobo and position palettes for the new fixture.

These are created in the Position, Colour and Beam workspace windows. This option is turned off by default but it's quite a useful starting point so is worth turning on.

- [Options], [AutoGroups] sets whether the console will automatically create groups from the fixtures you patch. If Enabled, a group is created for all fixtures of the same type, and another if you patch a quantity of fixtures.
- To show the DMX address for fixtures, press Window Open then Patch. To show patch details for a single fixture press Window Open then the fixture select button. On touch buttons the DMX address is displayed on the top right of the button in the format {DMX line}.{Address} (this display can be disabled using the context menu).
- If a patch goes over the capacity of a DMX line, the console will patch at the beginning of the next line. For example if you try to patch a Mac500 at channel 1.510, it will actually be patched at 2.1.

3.1.4 Capture Visualiser Auto Patch

If you want to use Capture Visualiser, start it by pressing Window Open then [Open Workspace Window] then [Visualiser]. Some consoles also have a dedicated Visualiser button. Capture will open in a workspace window with an automatic representation of your patch.

If you have another monitor connected, you can move the Visualiser window to it by pressing Window Open then [Window Options] then [Move Screen], or by holding Avo and pressing Size/Position.

You will see the fixtures you have patched laid out on screen in handle number order. You can then use the Visualiser controls to reposition the fixtures if you wish – see chapter 10.

- You can turn off Auto Patch in the Capture Visualiser settings.

3.1.5 Patching fixtures with multiple cells (sub fixtures)

Some fixtures have multiple cells of control within a single fixture (for example an RGB LED batten). To avoid having to patch every cell as a single fixture, you can patch the whole fixture as one "super fixture" and each cell will then appear as a "sub fixture". This is very useful when laying out fixtures for use with the Pixel Mapper as it allows you to move and rotate the fixture as a single fixture, but keep individual control over the cells.

If you access the fixture using the handle it is patched on, all cells of the fixture will be controlled together. To access the sub fixtures independently, use the Attributes window or you can press Unfold then the select button of the fixture. In the Fixtures workspace, the current page of fixtures will be replaced by select buttons for each individual fixture cell. You can also select subfixtures from the numeric keypad. See section 4.1.4 on page 74 for more details of working with fixture cells.

To go back to normal, press Unfold then [Exit Unfold].



The Sub fixtures feature has to be defined in the fixture's personality. If sub fixtures does not work on your fixture you may need to obtain the latest fixture personality from Avolites.

3.1.6 Patching by RDM

RDM (Remote Device Management) is a system which allows the console to interrogate the lighting rig to find out what's there. It can then patch itself to match the existing DMX addresses. You can also remotely change modes and other settings on the fixture.



Fixtures must be equipped with RDM for this to work; many fixtures are not. Also if you have DMX buffers or splitters in your rig, they must be RDM enabled or they will block the information being sent back to the console.

Press Window Open then Patch to open the Patch View window then select the RDM tab. All devices which support RDM will be listed here. Click the Full Discover context menu button to rescan the rig for RDM devices.

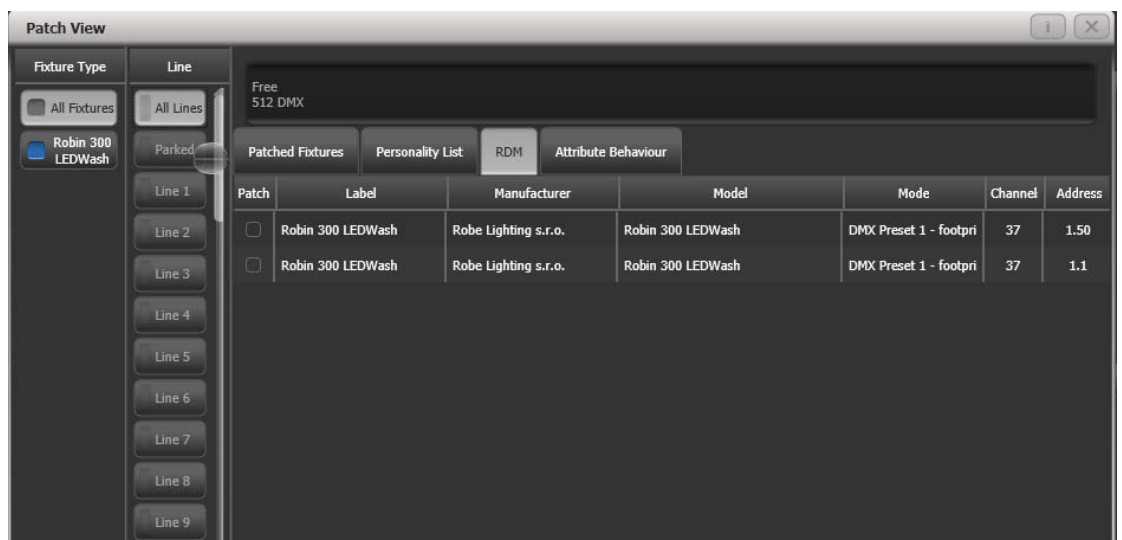

- Select one or more fixtures in the grid and click the Patch context menu button to patch the devices.
- Click on the Mode or Address cells in the grid to change these settings remotely.
- Click on the Identify button (at the right hand end of the screen, you might need to scroll to see it) to turn the fixture on so you can see where it is in the rig.
- Click on the RDM Quick Patch context menu button to automatically patch all RDM devices.

3.1.7 Finding a lost fixture

Sometimes a fixture may be rigged with the wrong DMX address set, or connected to the wrong DMX line.

The Find Fixture function allows you to find the start address of the fixture by scrolling a "locate" state through all possible DMX addresses, avoiding a trip up the rig to look at it. When the fixture responds with its Locate state, you know its DMX address.

- 1> Press Patch, [Fixture] and select the type of fixture you are looking for
- 2> Press [Options], then [Find Fixture] to enable the Find Fixture mode.
- 3> Turn Wheel B to go through all possible DMX addresses. Wheel A sets DMX lines.
- 4> When the fixture responds with its Locate state, you have found the correct DMX address.
- 4> Turn off [Find Fixture] mode and (if not already occupied) patch the fixture. The DMX address/Line will be automatically set to match the Find Fixture settings.

- On consoles with 3 wheels, wheel C (DMX Slot) jumps through DMX addresses using the fixture channel count (for example if a fixture uses 16 channels, it will jump through in 16's).

3.2 Changing the patch

3.2.1 Patch View

The Patch View window gives a full overview of how all the fixtures in your show are patched, and allows you to patch, repatch, legend, renumber, invert, pan/tilt swap, freeze, exchange, park and view fixtures. If you need to change the settings of multiple fixtures (for example, changing the DMX address of several fixtures) then it's really easy to do in one operation in the Patch View.

To show the Patch View window press Window Open then Patch, or use the Open Workspace Windows menu command.

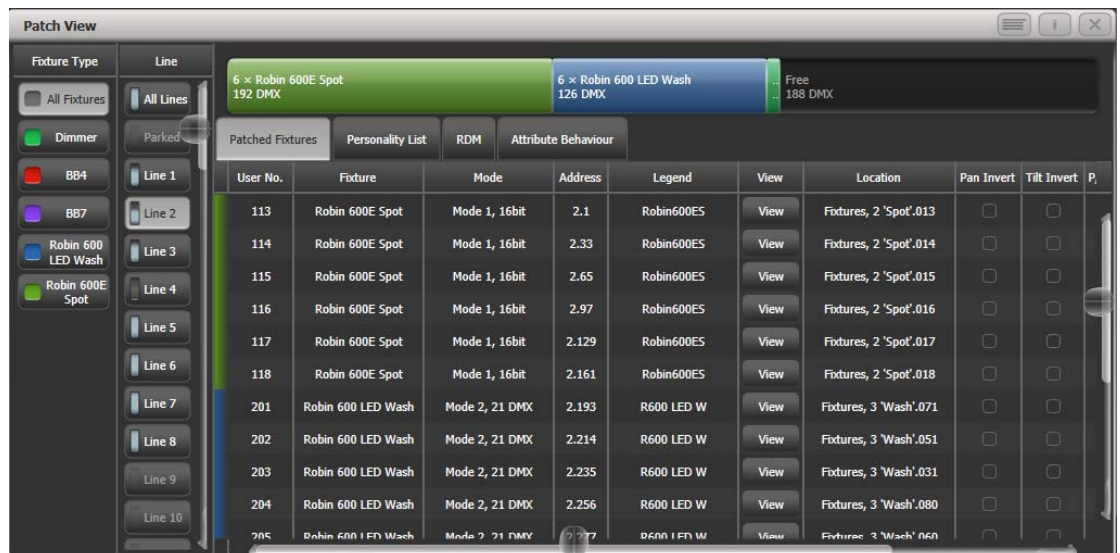

Fixture type: lists the different types of fixture in your show. Each fixture has a unique colour code. Click on these buttons to filter the view so it only shows one fixture type.

Line: lists the available DMX output lines/universes. The blue bargraph in the button shows how much of the line is used by patched fixtures and how much is free. Click a button to show the details of that line in the right hand side of the window.

The **coloured bar** at the top shows how fixtures are patched on the selected output line, using the unique colour code for each type of

fixture. Click on a section of the bar to select those fixtures in the grid below.

The **grid area** shows details for each patched fixture on the selected output line. Some parameters are editable by clicking in the grid, then the softkeys allow you to change the parameter.



You can change parameters for multiple fixtures by dragging a selection box over the grid, or hold the Ctrl button on the keyboard and click on the required fixtures. Then edit the parameter on the softkeys, and use the [Set] context button or press Enter to update the selected fixtures.

- You can switch off some of the display columns to make the Patch View simpler. Press the [Choose Columns] context menu button and then use the options on the softkeys to turn columns on and off.
- You can add notes to each fixture in the Patch View. Click on the Notes field and enter text using the keyboard.

The tabs across the top allow you to switch the window to Personality List (lists all fixtures available on the console), RDM (allows you to patch devices using RDM) and Attribute Behaviour (allows you to set invert, freeze, curve, and limit. See section 3.4.2 and following sections for Attribute Behaviour.

A context menu option allows you to show or hide parked fixtures. If you show parked fixtures they will appear greyed out in the position they were originally patched.

3.2.2 View detailed fixture information

In the Patch View window click on the View button for the fixture you wish to view, or press Window Open followed by a fixture handle. A Fixture View window will open showing details for that fixture, including the personality and mode used to patch, and the individual DMX channel addresses for each attribute. Attributes can be inverted or frozen by clicking on the checkboxes at the right hand side.

Channel Name	Cell	Channel Offsets	Channel Addresses	Inverted	Frozen
Pan	-	1, 2	2.1, 2.2	<input type="checkbox"/>	<input type="checkbox"/>
Tilt	-	3, 4	2.3, 2.4	<input type="checkbox"/>	<input type="checkbox"/>
P/T Speed	-	5	2.5	<input type="checkbox"/>	<input type="checkbox"/>
Control	-	6	2.6	<input type="checkbox"/>	<input type="checkbox"/>
P/T Macro	-	7	2.7	<input type="checkbox"/>	<input type="checkbox"/>
P/T Macro Spd	-	8	2.8	<input type="checkbox"/>	<input type="checkbox"/>

If the fixture address is set using DIP switches, the console can show you how to set the switches by clicking on the DIP Switches tab.

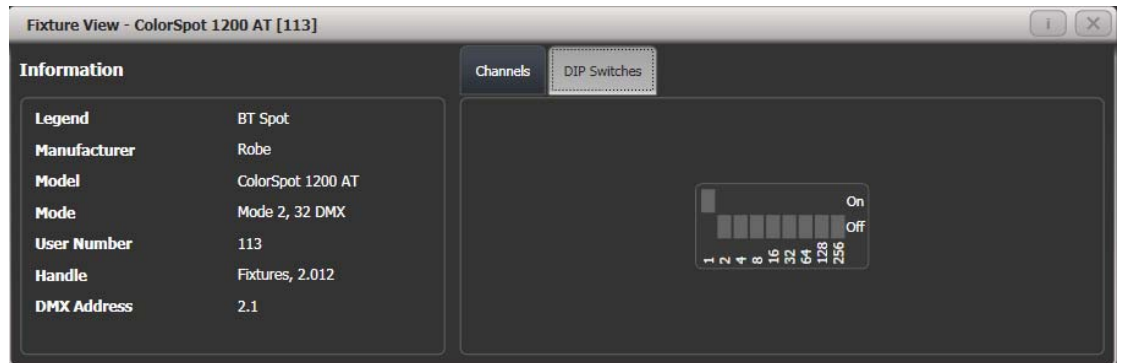

There is also a Personality tab (not shown in the pictures) which shows history information about the personality file for the fixture. This can be useful for checking the version of the personality file.

3.2.3 Changing DMX addressing using Patch View

You can easily change the DMX address of one or more fixtures from Patch View. Select the DMX address cells you want to modify.

Mode	Address	Legend	V
Dimmer	2.319	Blinder	V
Dimmer	2.320	Blinder	V
Dimmer	2.321	Blinder	V
Dimmer	2.322	Blinder	V
Dimmer	2.323	Blinder	V
Dimmer	2.324	Blinder	V
Dimmer	4.40	S4	V

Type the new address for the first fixture in the selection and press Enter (using the format Universe . Address – if you miss out the universe part it will stay unchanged).

All fixtures will be renumbered keeping the addressing offset between the fixtures the same (in other words if each fixture takes 20 channels, the addresses will be set with an offset of 20 channels between each fixture).

The [Swap Fixture Addresses] softkey lets you swap the addressing between two groups of fixtures. This operates in two modes, [One For One] or [Retain Layout], which you can select by softkey after pressing [Swap Fixture Addresses].

Select one group, then press [Swap Fixture Addresses] and select the target group. In One for One mode the target must be the same quantity of fixtures or the console will display an error. In Retain Layout mode the console will attempt to add or remove fixtures to get the same quantity – if this conflicts with other fixtures it will give you the options to [Park Conflicting] or [Cancel].

3.2.4 Changing DMX address using Patch menu

As well as using the Patch View screen, you can use the Patch menu to re-patch a fixture to a different DMX address or a different DMX output line. All programming is kept.

-
- 1> Press Patch (if you're not already in Patch mode).
 - 2> Press [Repatch Fixtures].
 - 3> Press the Select button of the fixture you want to change.
 - 4> To change DMX press [Address], type the new address and press enter. If this address is already in use, a warning icon will be shown.



- 5> To change the DMX output line, press [DMX Line=x] and enter a new output line number 1-12.
 - 6> Press Enter or [Repatch] to confirm the change.
 - 7> Repeat from step 3 if you want to change other fixtures.
-

- You can "Park" the fixture using [Park]. This removes the fixture from the DMX output map, but all programming is retained. The original DMX line and address is remembered and you can restore it using the [Unpark] option.
- If the new DMX address already has another fixture or dimmer patched on it, the console will warn you (unless this is disabled in User Options, see section 13.1.3 on page 233). You can either press [Select another DMX address] to abort the change or [Park Conflicting Fixtures]. All programming for the parked fixture is preserved, but you need to repatch it to a free DMX address using the above procedure before you can use it again. If you press [Always Park Conflicting Fixtures] the console will park this and any future conflicting fixtures without warning you (you can change this option back in the User Settings).

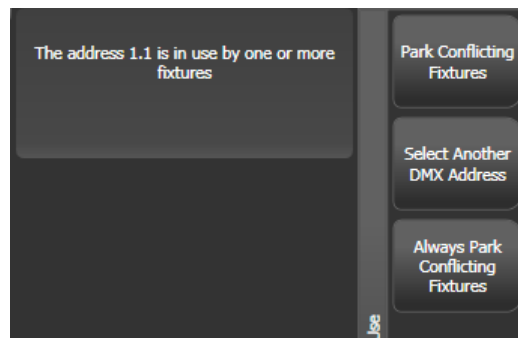

3.2.5 Setting legends

You can set a legend for each fixture or dimmer you've patched which is displayed in the Fixture Select touch button. This can be really useful to help you identify the fixture.

-
- 1> At the main menu press [Set Legend].
 - 2> Press the Select button for the fixture you want to legend.
 - 3> Type the legend on the keyboard.
 - 4> Press Enter when you have finished.
-

- You can also choose to have a picture legend using the softkey options.

- You can set the same legend for multiple fixtures by selecting a group of fixtures after pressing [Set Legend].
- You can automatically allocate User Numbers for multiple fixtures by selecting a group of fixtures, then using softkey A on the Set Legend menu. The first fixture will have the User Number you entered, and the other selected fixtures will be given a number increasing by 1 for each fixture.
- You can set a legend for the current page of fixtures using the [Set Legend] function from the main Program menu. The legend is shown on the touch button for the page and on the HUD.

3.2.6 Fixture button halo

You can configure fixture buttons to have a “halo” colour which helps you to find them quickly. Halo colours can be set manually for each fixture (the default setting), or automatically by fixture type using the fixture colours used in the patch window..

To set a manual halo colour, click [Set Legend], click the fixture button (or select multiple buttons) then select the [Halo] option. A colour picker will open to let you set the colour, or pressing [System Colours] will give you colour options on the softkeys. A [Remove Halo] softkey lets you remove the colour.



To enable automatic halo colours, hold Avo and select [User Settings], then [Handles], then set Fixture Halos to [Auto]. Fixture buttons will then be coloured to match the automatic fixture colours used in the Patch window.

Halo colours are also shown in the Intensity View and Show Library workspace. In list views such as DMX, Channel Grid, Cue View and Palette view the halo colours are shown as a bar to the left of the list – this uses the user halo colour if one is set, otherwise the automatic colour is used. The User Setting does not affect this display.

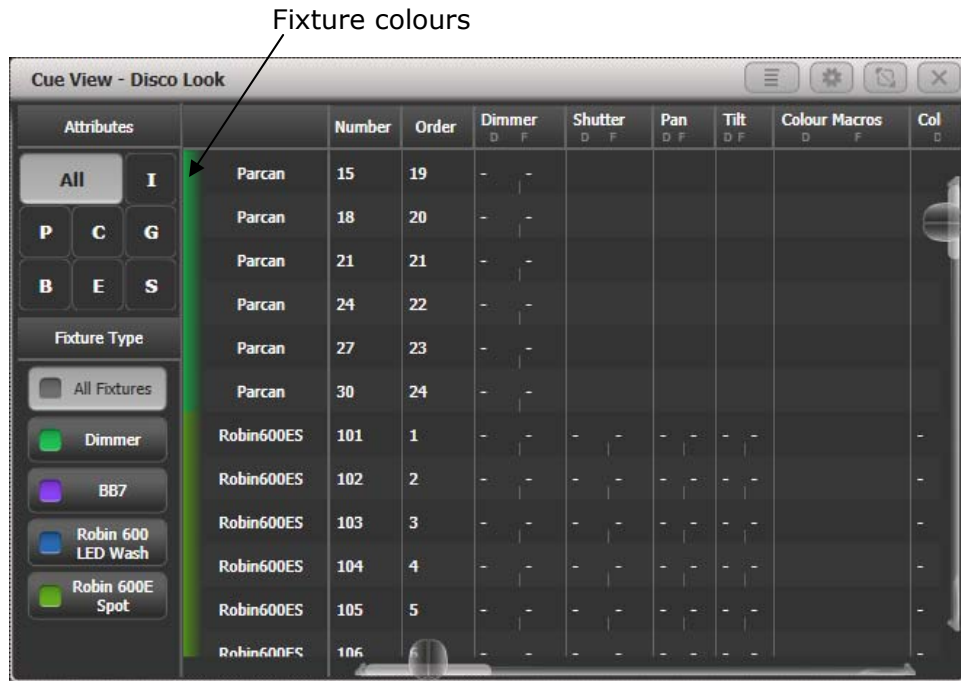

3.2.7 DMX view window

When you're having problems getting fixtures to work it can be useful to see the actual DMX output values coming from the console. Press Window Open, then [Open Workspace Window], then select [DMX].



Line	Index	Line	Address	Control	Output
Line 1	1	1	1	Dimmer	227
Line 2	2	1	2	Dimmer	0
Line 3	3	1	3	Dimmer	196
Line 4	4	1	4	Dimmer	0
Line 5	5	1	5	Dimmer	0
Line 6	6	1	6	Dimmer	0
Line 7	7	1	7	Dimmer	30
Line 8	8	1	8	Dimmer	0
Line 9	9	1	9	Dimmer	0
Line 10	10	1	10	Dimmer	0
Line 11	11	1	11	Dimmer	0
Line 12	12	1	12	Dimmer	0
	13	1	13	Dimmer	0
	14	1	14	Dimmer	0
	15	1	15	Dimmer	0
	16	1	16	Dimmer	0

The buttons on the left let you select the different output lines from the console. Scrolling the window to the right shows more information about each DMX channel.

3.2.8 Fixture Exchange

The Fixture Exchange function enables you to repatch fixtures in your show using alternative fixtures, retaining important elements such as cue times, shapes and legends. This is very useful for touring shows and venues with a high turnover of events.

Fixture Exchange works best if you use Palettes to create your cues. This allows you to adjust for position differences and so on by reprogramming a few position palettes, rather than having to reprogram every cue. Cues recorded with absolute values will need to be re-recorded, preferably using palettes.

The pan, tilt and dimmer will always be preserved from one fixture type to the next. For other attributes, the console will attempt to match the functions between the fixtures, but you can change the details of this using the Exchange Mapping function (see next section). All programmed items including palettes will be preserved,

so the programming can be easily adjusted by updating your palettes as normal.

Fixture exchange also gives you a powerful way to re-use an existing show with new lights, so you can give yourself a programming head start when faced with a new fixture.

- It's a good idea to save your show before performing major changes such as fixture exchange. Should you change your mind or have problems, you will easily be able to return your show to its previous state.

-
- 1> *Enter patch mode by pressing Patch.*
 - 2> *Select the new fixture type you wish to use.*
 - 3> *Touch the select button of the fixture which is to be exchanged.*
 - 4> *The console will warn you that the fixture is in use. Press the [Exchange Fixture] option.*
 - 5> *Repeat from step 3 to exchange other fixtures with the same type of new fixture.*
-



After exchanging fixtures you need to update the palettes which used those fixtures. If you have trouble switching values off in a palette, set new values for all the attributes in the attribute group and re-record the palette. You should then be able to switch off an attribute group as required.

3.2.9 Exchange Mapping

When you exchange fixtures the console will attempt to map the functions on the new fixture to the same functions on the old fixture so that your show does not look any different with the changed fixtures.

However, this may not always work out quite right, so using Exchange Mapping you can manually map functions between the fixtures. For example this allows you to map the old gobos to similar new gobos even if they are not in the same wheel position, and to ensure that rotation speeds work the same.

Any changes made will apply immediately to the show. Mappings are remembered and will be used whenever you exchange the same fixtures in the future (though you can restore to factory mappings at any time should you need to using the [Clear All Mappings] softkey).

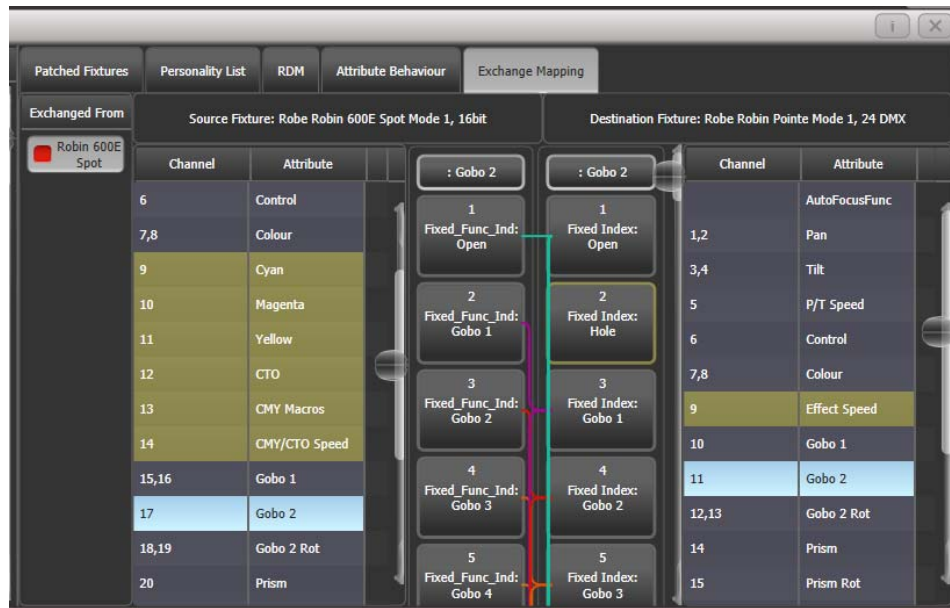

To set up mapping:

- 1> Press Window Open then Patch to show the Patch View screen.
- 2> Select the Exchange Mapping tab.
- 3> In the leftmost column, click the fixture type of the new fixture which you have changed to.
- 4> The view shows the old fixture on the left and the new fixture on the right with attributes listed for both fixture types. You can sort the list either alphabetically or in DMX channel order using the [Sort] context menu option.
- 5> Select an attribute to show the mapping. The mapped attribute on both fixtures will highlight in light blue. Brown controls are not mapped. The centre of the view shows the individual functions of the selected attribute, and coloured lines show how these map between the fixtures.
- 6> To map a function, click on a source function then a destination function. Any previous mapping will be removed. You can map multiple source functions to a single destination function.
- 7> To unmap a function, double click the source function. If there are multiple sources mapped, double click the destination function.
- 8> To move a mapping, click the existing destination, then click the new destination.

- Where a fixture has been exchanged from more than one source fixture you can switch between them by selecting the relevant source fixture under the 'exchanged from' column.
- When you change the mapping, the 'Unsaved Changes' options will pop up at the bottom of the screen. Here you can store the new mappings by pressing Apply, forget the changes by pressing Cancel or restore all mappings to Avolites factory default by pressing Reset. All these actions have to be confirmed by pressing the [Confirm] softkey.

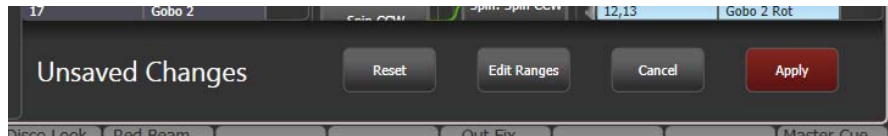

Range mapping

If the destination function has a range (for example 0-100%) you can adjust the range to which the source function is mapped.

Where multiple source functions are mapped to a single destination function with a range, separate destination buttons are shown allowing you to set a different destination range for each source function.

To set the range, first select a destination function, then click the Edit Ranges option at the bottom of the window. Then select the function whose range you wish to change. (Note that it is only possible to adjust the range of a mapped function. Any functions that are not mapped or are not ranges will grey out). You can then adjust the maximum and minimum values for the range either by wheel, by touching the wheel view on touch consoles or by selecting the relevant softkey and entering the value.

Once complete, click Apply then [Confirm] to commit the changes or Cancel then [Confirm] to forget.

3.2.10 Update personalities

This option allows you to update the personality for a fixture used in your show. Normally a copy of each fixture personality in the show is saved in the showfile, so updating the personality library on the console does not update fixtures which are already patched.

- It's a good idea to save your show before using Update Personalities, then you will be able to undo any changes if you change your mind or have problems.

-
- 1> Enter patch mode by pressing Patch.
 - 2> Press [Update Personality] to update an individual fixture type, or [Update All] to update all patched fixtures to the most recent version in the library.
 - 3> If updating individual fixtures, the console shows you a list of personalities used in the show which can be updated.
 - 4> If updating individual fixtures, press the personality you want to update.
-

- The new personality is loaded from the Titan/Personalities folder.

3.3 Copying, moving and deleting fixtures

3.3.1 Copying or moving a patched fixture

Using the Copy button you can make a copy of an existing fixture or move it to a new button. You cannot link fixture buttons. You can copy or move multiple fixtures in one operation.

Move is useful for tidying up the console.

-
- 1> *Press the Copy button.*
 - 2> *Select [Copy] or [Move]. Pressing the Copy button again will also toggle through these options.*
 - 3> *Press the Select button of the fixture you want to copy/move. You can select multiple fixtures.*
 - 4> *Press the empty Select button where you want it to go.*
-

- The Menu Latch button latches the Copy/Move/Link menu, so you can keep copying or moving things without having to keep pressing the Copy/Move/Link button. Press again to unlatch.
- There is also a Move button for instant access to the move function.
- The [Retain Layout] or [Bunch Up] option is used when copying a group of fixtures with empty handles in the group – you can either keep the empty handles, or bunch up the used handles together. There is also a [Bunch Up With Offset] option which allows you to leave a gap in the DMX channels, if you are running a show where you need to exchange fixtures to ones which use more DMX channels.
- When in Copy mode, option [Copy Legends] can be changed to [Don't copy legends] so that the copied fixtures are given default legends.
- When in Move mode, [Swap Items if Required] will attempt to reposition any existing handles which are in the way of the move. This is useful when rearranging buttons on a page which is nearly full.

3.3.2 Using copied fixtures

Fixture copying is very useful if you need an additional fixture of a type you've already patched and programmed. The new copy will come complete with all the cues and palettes of the original fixture you've copied.

The copied fixture will be "Parked" (have no DMX channel allocated) and you will need to repatch it before you can use it (see section 3.2.1 above).

3.3.3 Deleting a patched fixture

You can delete a fixture or dimmer from a button if you patched it accidentally or if you change your rig and want to use the button for something else.



All programming for the fixture is also deleted. You cannot undo deletion of a fixture or get the programming back by repatching a fixture to the same handle.

If you might need the fixtures again later, move them to an unused fixture page.

-
- 1> *Enter Patch mode by pressing the Patch button.*
 - 2> *Press the Delete button.*
 - 3> *Press the Select button of the fixture you want to delete.*

4> The button will light up red and the console asks for confirmation. Press the Select button again to confirm.

- You can delete a range of fixtures in one operation.

3.4 Advanced options

All of the options below can also be set from the Patch View window.

3.4.1 Swap pan and tilt

This allows you to make the pan channel control tilt and the tilt control pan. This can be useful for fixtures rigged in strange orientations.

- 1> Press Patch.
 - 2> Press [Edit Fixtures].
 - 3> Press [Swap Pan and Tilt].
 - 4> Select the fixtures to be pan-tilt swapped. Press [Pan and Tilt ...] to select either [Swapped] or [Normal] for the selected fixtures.
 - 5> Press Exit when finished.
-

3.4.2 Invert attributes

This option inverts individual attributes of fixtures. Useful if you have a fixture which pans right when the rest pan left, saving a trip up the rig to set fixture options, but you can invert any attribute.

- 1> Press Patch.
 - 2> Press [Edit Fixtures].
 - 3> Press [Invert Attribute].
 - 4> Select fixture(s) to be changed.
 - 5> Select the attribute to invert from the softkeys. The display shows [Inverted] when the attribute is inverted.
 - 6> Press Exit to finish.
-

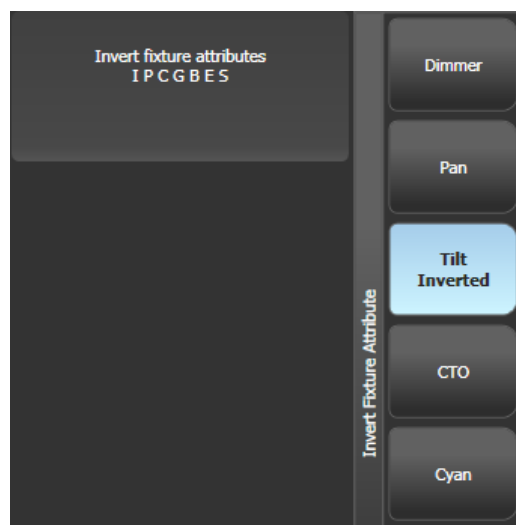

- You can change the invert on multiple fixtures by selecting more than one, but the "Inverted" display will not show if there

is a mixture of inverted and non-inverted fixtures in the selection.

- Some attributes cannot be inverted.
- Invert can also be set from the Attribute Behaviour tab of the Patch View window.

3.4.3 Attribute limits

You can set upper and lower limits for any attribute. This can be useful for example to limit the pan/tilt movement of a fixture, or if a fixture has a combined dimmer/strobe function and you only want the dimmer part of the operation.

Attribute limits are set either from the Edit Fixtures menu or using the Attribute Behaviour tab of the Patch View window.

-
- 1> Press Patch.
 - 2> Press [Edit Fixtures].
 - 3> Press [Set Limits].
 - 4> Select the fixtures to be set.
 - 5> Use the softkeys to select which attributes are to be set, then select upper or lower limit.
 - 6> Input a percentage value for the limit value, or press [Set To Current Value]. To remove a limit press [Remove Limit].
 - 7> Press Exit when finished.
-

From the Attribute Behaviour tab, use the context buttons to set Attribute Limits.

It is still possible to put values into the programmer outside the limits. A "limited" watermark will appear on the wheel view behind an attribute when it is being limited.



3.4.4 Fixture Offset

You can set an offset to any attribute of any fixture. The normal use for this is to correct pan/tilt positions when fixtures are rigged in a different orientation to how they were programmed. The offset is applied to channels just before final output.

There are 4 ways to set an offset:

- Select fixture, Locate, then adjust attributes to the desired locate value. Then press Record, Locate, [Update Offset]. This does not change the actual locate value but sets the difference

between the locate position and your set position as the offset. This is an easy visual way to set the offset.

- You can also set offsets using palettes. Select fixture, apply palette, adjust fixture to desired values then press Record, Palette, [Update Offset]. Again this does not change the palette, but sets the difference as the offset value.
- In the Patch View window, in the Patched Fixtures list there are cells for Pan or Tilt offset
- In the Patch View window, in the Attribute Behaviour tab you can select [Offset] from the context menu buttons. This lets you view or adjust offsets set by the first two methods.

3.4.5 Fixture / Attribute curves

Curves set how an attribute behaves over the full range of values. They are most often used for dimmer attributes to set the way the dimmer level follows a slider, but can be applied to any attribute.

Curves are set either from the Edit Fixtures menu or using the context buttons on the Attribute Behaviour tab of the Patch View window.

-
- 1> Press Patch.
 - 2> Press [Edit Fixtures].
 - 3> Press [Set Curve].
 - 4> Select the fixtures to be set.
 - 5> Use the softkeys to select which attributes are to be set.
 - 6> Use the softkeys to select the type of curve required. The normal setting is Linear.
 - 7> Press Exit when finished.
-

See section 13.7 on page 251 for details of the different curves available.

3.4.6 Freeze fixtures or attributes

This option allows you to freeze individual attributes of a fixture, or to freeze the whole fixture. Attributes or fixtures which are frozen are not affected by playbacks or by the programmer.

-
- 1> Press Patch.
 - 2> Press [Edit Fixtures].
 - 3> Press [Freeze Fixture or Attribute].
 - 4> Select the fixtures to be frozen/unfrozen.
 - 5> Use the softkeys to select which attributes are frozen, or to freeze the whole fixture. Frozen attributes are indicated on the softkey.
 - 6> Press Exit when finished.
-

- Freeze can also be set from the Attribute Behaviour tab of the Patch View window.
- A "Frozen" watermark is shown on the wheel display when an attribute is frozen.

3.4.7 Editing the personality

Sometimes you may find a fixture personality contains errors and needs editing. You can edit personalities directly on the console.

-
- 1> *Press Patch.*
 - 2> *Press [Edit Fixtures].*
 - 3> *Press [Edit Personality].*
 - 4> *The softkeys show a list of all fixture types patched in your show. Select the fixture type to be edited.*
 - 5> *Personality Builder will open allowing you to edit the personality.*
 - 6> *When you save changes, your show will be updated with the edited personality. Your changes are also saved to the fixture library on the console.*
-

- Edited personalities will be saved in the User/Custom personality folder at D:\Personalities (if using the simulator, the folder is at \My Documents\Titan\Personalities). Personalities in this folder are searched and loaded before those in the library and are not overwritten when a new fixture library is installed.
- A separate user guide for Personality Builder is available from the Avolites website.

4. Controlling dimmers and fixtures

When you are programming a show, and sometimes when you are running a show, you need to manually control the fixtures and dimmers to set the intensity, position, colour, etc. To do this you first select the fixtures you want to change using the select buttons, then you set the attributes of those fixtures using the Wheels and Attribute buttons.

You can also set fade/timing information for each attribute of each fixture which is treated as an additional attribute of the fixture.

4.1 Using the select buttons and wheels

4.1.1 Selecting fixtures and dimmers for control

To select the fixtures or dimmer channels that you want to control, you use the Fixture Select buttons to select the fixtures into the Editor. You can select fixtures or dimmers individually, or several at once. You can also use Groups to select multiple fixtures, see section 4.3.1 on page 92.

If the fixture is patched on a fader handle, press the blue button to select the fixture.



- 1 > Press the Select buttons for the fixtures you want. Touch buttons will light up pale blue when selected, physical buttons will light brightly.
- 2 > To select a range of fixtures, slide your finger across the touch buttons to draw a selection box. For fixtures patched on faders, hold down the Select button for the first fixture then press the Select button for the last fixture.

Here are some other useful things to know:

- Press Locate (at the bottom right of the console) to light up the selected fixtures in open white and move them to a central position. See the next section for more Locate options.
- You can deselect a fixture by pressing the select button again.
- In the system display area of the touch screen, the console will show you which fixtures are currently selected.

- Press Clear (right of numeric keys) to deselect all fixtures and remove all changes from the programmer. See the next section for more Clear options.
- Once you have changed any attribute, pressing a Select button will deselect all fixtures and start the selection process again. All previously selected fixtures (since you last pressed Clear) stay in the programmer. Once a fixture has been edited, Fixture buttons show a darker blue. The picture above shows the first two fixtures selected, with the second three in the programmer and the others unselected.
- You can select fixtures on another page by touching one of the page buttons to the left of the fixture buttons, if you have 'Pages' set to Show (using the context button). Otherwise you can use the scroll slider to show more buttons. On fader handles, Page buttons are provided to change pages – on the Pearl Expert these are above the numeric keypad, on other consoles they are next to the faders.
- Using Key Profiles (see section 13.4.1 on page 242) you can set the fixture touch button to latch mode so that it turns the fixture's dimmer channel on (like putting a preset fader to full).

4.1.2 Setting fixtures to a start position (Locate)

The Locate button (the button on the bottom right corner of the console) is used to put the fixture into a known position with light coming out, so that you can start programming it.

A quick press of the button will move all selected fixtures to a central position and reset all the attributes so that you get a white light. However you sometimes might not want to move the fixture, and by holding down the Locate button, you get some more options.

- You can mask off some of the Locate settings (such as only turning the fixture on, but not changing its position or colour) by holding down Locate and pressing [Set Mask to Exclude All]. Then (still holding Locate) turn on the Attributes you want to change using the Attribute buttons. Only the lit attributes will be changed by Locate. Pressing the Attribute Options button will clear the mask.
- Option [Auto Reset Mask] sets the mask to be automatically reset to include everything each time Locate is pressed, or you can toggle the option to [Remember Mask] which will keep the mask setting you used last time.
- Option [Clear/Don't Clear Located Attributes] sets whether the attributes changed by the Locate function will be saved into any cues you store. If the option is set to "Clear" then the Located attributes will not be stored in the Programmer unless you modify them using the wheels. This is useful if for example you want to program a cue which sets the position of fixtures, but does not turn them on. The Locate button will light up the fixtures for programming, but the lit state will not be stored in any cues you save.



To quickly locate without changing pan/tilt, hold Locate and press the Pan/Tilt (or Position) button, then release Locate.

To quickly locate pan/tilt only, hold Locate, press

Attribute Options (just above Locate), then press Pan/Tilt (or Position), then release Locate.

Changing the locate state

You can permanently change the locate state of each fixture by recording a new Locate State. This can be shared (applies to all fixtures of the same type) or individual. To store, set up the desired locate state, then press Record, then Locate. Select [Shared] or [Individual] from the softkeys. Press Record or Locate a second time to confirm.

4.1.3 Clearing selection

The Clear button (on the right of the numeric keypad) is used to remove all changes from the Programmer and deselect all fixtures. A quick press of the Clear button just clears everything, however if you hold down the Clear button, then more options are available.

- You can mask which attributes are to be cleared (for example, leaving the pan/tilt in the programmer but clearing everything else) by holding down Clear and pressing [Set Mask to Clear Nothing]. Then (still holding Clear) turn on the Attributes you want to change using the Attribute Bank buttons down the right hand side, or press [Set Mask] and use the softkeys. Only the lit attributes will be cleared. Pressing the Attribute Options button will clear the mask. The Time mask option allows you to clear or retain the fade/delay times in the programmer for all attributes (clearing individual attributes will also clear times for that attribute, for example setting a P mask will clear position times).
- [Clear Options] opens a submenu showing some further options (described below).
- [Clear All Fixtures/Selected Fixtures] sets whether all fixtures will be cleared from the programmer, or if only currently selected fixtures will be cleared. This is useful if you want to clear specific fixtures.
- [Individual Attributes] allows you to clear individual attributes from the Programmer. When you press the softkey, you are given a list of attributes in the Programmer – press the appropriate softkey to clear that attribute.
- [Clear All Programmers] will clear all programmers that are currently active on the console. This will be used for multi-user programming in future and is currently used to clear values added to the Titan Remote programmer.

The options in the “Clear Options” submenu are:

- [Auto Reset Mask] sets the mask to be automatically reset to clear everything each time Clear is pressed, or you can toggle the option to [Remember Mask] which will keep the mask setting you used last time.
- [Leave/Zero Preset Fader Levels] is used to set whether latched fixtures are cleared (the fixture key profile can be set to “Latch” mode, which turns on the fixture dimmer channel when the fixture button is touched. See section 13.4.1 on page 242.)

- [Freeze current values] sets what happens to LTP (non-intensity) channels you have modified. If set to [Freeze Current Values] the channels remain as you set them. If set to [Release To Playback Values] the channels will go back to how they are set in the current playback. For example: you have an active playback making some lights green, then you select the lights and change them to red. If you press Clear with this option set to [Freeze] then the lights remain red. If the option is [Release] the lights will go back to green.
- [Clear/Maintain Cue Times] - determines whether or not to clear the cue time information from the programmer (this will not affect fixture attribute times in the programmer).

You can use the Channel Grid window to selectively view and remove attributes from fixtures. See section 4.2.1 on page 89.



If you type a number then press Clear, HTP values in the programmer will fade out over that time, for example 5 Clear would fade over 5 seconds. This can be very useful if you are trying to be subtle when making changes during a show.

4.1.4 Fixtures with multiple cells/subfixtures

If a fixture has multiple cells of control (for example an RGB LED batten) and its personality supports it, you can select and control the fixture either as a whole or as independent cells. This is particularly useful when using Shapes or the Pixel Mapper.

If you select the fixture using the handle it is patched on, all cells of the fixture will be controlled together.

You can use the buttons which appear at the top of the attribute editor window to select the main fixture, or individual cells for control (use the [Open Workspace Window] softkey to open the Attribute Editor window).



You can also use Unfold to expand the cells onto individual select buttons. In the Fixtures workspace, the current page of fixtures will be replaced by select buttons for each individual fixture cell. On fader handles, the unfolded fixture cells will start at handle 1.

There are two ways to unfold fixture cells:

- Press Unfold then select range of fixtures. The cells will immediately appear on the handles.
- Select fixtures, press Unfold, then press [Selected Fixtures]. This method allows for non-consecutive fixtures to be unfolded.

To go back to normal, press Unfold then [Exit Unfold].

You can also use the numeric keypad to quickly select cells. The syntax is as follows:

.	all sub fixtures of selection	n.	all sub fixtures of fixture n
. THRO .j	sub fixtures 1→j of all selected fixtures	n. THRO	all sub fixtures of fixture n→last consecutive of type n
THRO .j	shorthand for above	n. THRO i	sub fixtures 1→i of fixture n
.m	sub fixture m of all selected fixtures	n. THRO i.j	sub fixtures 1→j of fixtures n→i
.m THRO	sub fixtures m→last of all selected fixtures	n.m	sub fixture m of fixture n
.m THRO .j	sub fixtures m→j of all selected fixtures	n.m THRO	sub fixtures m→last of fixture n
.m THRO j	shorthand for above	n.m THRO i	sub fixtures m→i of fixture n
n THRO i.	all sub fixtures of fixtures n→i	n.m THRO i.	sub fixture m→last of fixtures n→i
n THRO i.j	sub fixture j of fixtures n→i	n.m THRO i.j	sub fixtures m→j of fixtures n→i
n THRO .j	sub fixture 1→j of fixture n	n.m THRO .j	sub fixtures m→j of fixture n

4.1.5 Changing attributes using the wheels

“Attributes” are the functions of the fixture, like pan, tilt, colour, dimmer, etc. You select which attributes you want to modify using the Attribute Bank buttons and set values using the wheels. The attributes available depend on the fixture type. Dimmer channels only have a dimmer attribute.

You can also select attributes by touching the IPCGBES buttons on the touch screen, and modify them using the Attributes workspace window; this is described in the next section.

Each attribute button controls several attributes, one on each wheel.

- 1> *With some fixtures selected, press the button for the attribute to be changed*
- 2> *Turn the wheels to set the attribute. The display above the wheels shows which attributes are being controlled, and the settings which are available scroll up and down as you turn the wheels.*

You can also touch the roller image on the screen to change the attributes up or down by one. For continuously variable controls like a dimmer, touching the roller will set the attribute to full or zero.

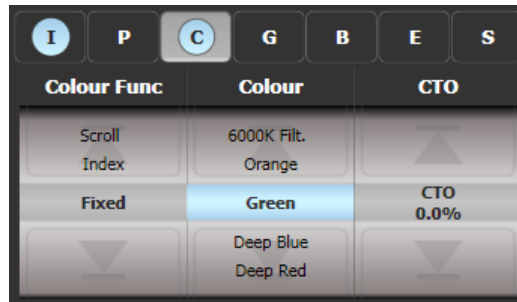

3> Repeat from 1 to change other attributes of the selected fixtures.

Some other things to know about attributes:

- If an attribute is in the programmer, it is highlighted (as shown with the "Green" setting in the screen picture above). This provides a quick way to see which attributes are in the programmer.
- You can also select the attribute to be changed from the softkeys by pressing the "Attribute Options" button.
- If the display above the wheels does not show the attribute when you press the button, that attribute is not available on the selected fixtures.
- If the wheel display shows a small arrow next to the legends, this means that there are further attributes to control. Press the Attribute button again to toggle through the attributes.

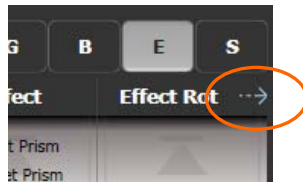

- The wheels operate in an "acceleration" mode. If you spin the wheel fast, the fixture changes in larger steps. If you move the wheel slowly, the fixture moves in its smallest increment.
- Holding down the Avo button while turning a wheel puts the wheel into "Fast" mode. When in this mode, a single rotation of the wheel changes the attribute you are controlling over its full range. For example, if while moving the Pan wheel you hold down Avo the fixture will make a complete pan movement between end stops in one rotation of the wheel.
- Some LED colour mixing fixtures have a Virtual Dimmer function (using the Intensity wheel) which offers intensity control by mastering the RGB levels when the fixture itself does not provide an intensity channel.

4.1.6 Setting attributes on the touch screen

The touch display above the wheels shows the attribute bank (Intensity, Position, Colour and so on) and the current values on the wheels.

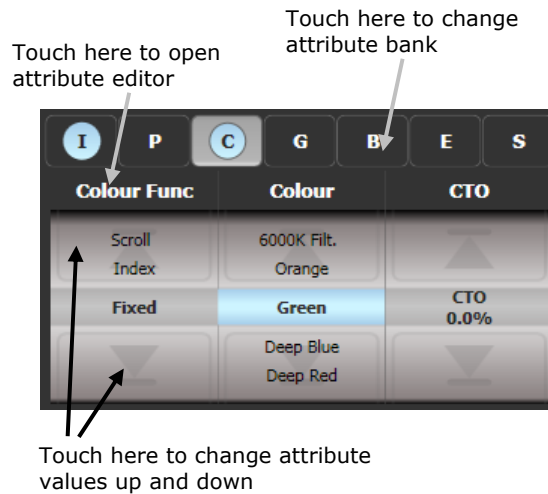

Touch the IPCGBESFX attribute bank buttons to change to a different bank. You can also use the physical attribute bank buttons as usual. The current attribute bank is shown with a grey background.

If attributes have been modified, the attribute button has a pale blue highlight.

The Roller display shows the attributes available on each wheel. These may be shown as a percentage value, or named values for attributes with fixed positions such as a colour wheel. If the attribute has been modified, the current value in the programmer is highlighted in blue.

You can touch the roller image to change the attribute to the next/previous value. For continuously variable controls like a dimmer, touching the roller will set the attribute to full or zero.

Attribute editor window

For attributes with fixed values such as gobos and fixed colour wheels, the Attribute Editor window can be easier to work with than the wheels. It also offers a colour picker window for fixtures with RGB or CMY colour mixing.

Press Window Open then [Open Workspace Window] then [Attribute Editor] to show it. As a shortcut you can also show it by touching the attribute name text just below the IPCGBES buttons.

The buttons on the left of the window select the attribute to change.



The rest of the window contains buttons or controls to set the attribute value. For attributes such as gobos and fixed colours, a button is provided for each one, making selection a lot quicker than scrolling through on a wheel.

When you apply an attribute, the button turns blue to show that the attribute is in the programmer. If you touch the button again, the attribute will be removed from the programmer.

Touching the title of each attribute (such as "Colour Func") expands the attribute to the full window, displaying more buttons.

For fixtures which are capable of colour mixing, you can select a colour from an onscreen palette of colours. The slider on the right hand side sets the intensity.

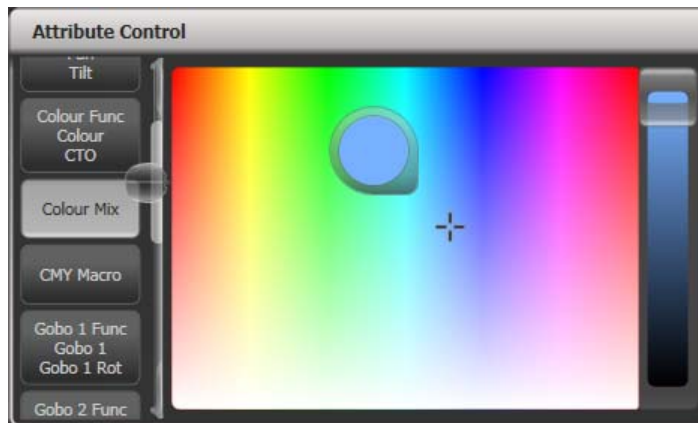

For LED fixtures with RGBW, RGBA or WW/CW attributes, the colour picker will also control the White/Amber channels. In versions previous to Titan v9 the White/Amber elements were not controlled by the colour picker and had to be set independently.

For variable attributes like Dimmer, holding down the button will display a horizontal slider bar. You can then move your finger left or right to change the value.



Active fixtures such as media servers will display a thumbnail of the media clip in the button. The media server must support CITP and be patched as an active fixture.

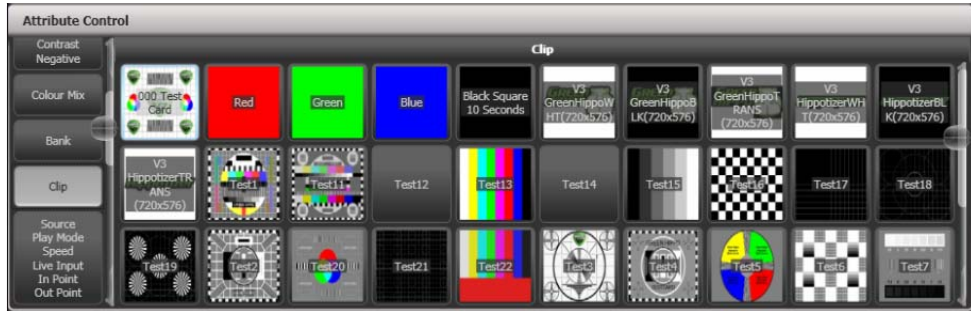

Fixtures which support keystoneing or blades/shutters can be controlled graphically in the attribute window. Select and drag the corners or sides of the image to control the fixture.

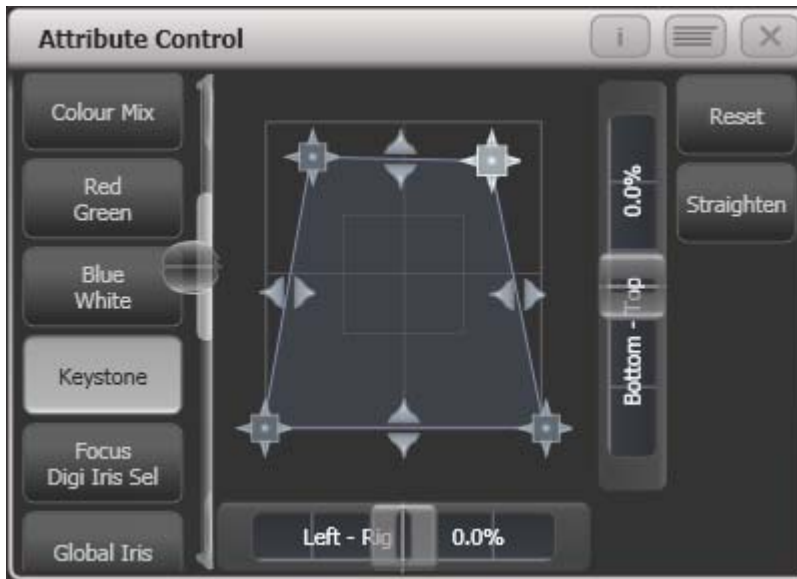

Updated personality files may be required to support the keystone/blade functions.

When the selected fixture has subfixtures, buttons appear at the top of the attribute editor window allowing you to select the main fixture, or individual cells for control.



4.1.7 Setting attributes from the softkeys

You can directly enter a numeric value for the attributes which are live on the wheels. You must be at the main Program menu to do this (keep pressing Exit until the vertical menu bar shows "Program Menu").

Type a number on the numeric keypad then press one of the softkeys to set the value to the fixture. The Softkey legend will show what effect your value is going to have (such as [Gobo 5], or [Deep Blue]).



For attributes displayed in percent, such as Dimmer, or Colour Mix, you enter a value from 0-100 to set the percentage output. For attributes where the output is divided up into ranges, such as colour wheels, you enter the index of the range you want. For example to select the 3rd colour (as displayed in the list above the wheel) you would enter 3.

4.1.8 Adjusting attributes with the @ buttons

Pressing the @ button next to a wheel opens the Adjust Attribute Value menu for that attribute.

You can also open this menu by touching the centre of the wheel view for the attribute, or by clicking on the attribute in the Channel Grid window.

The menu gives you the following functions:

- Select Function: gives you shortcuts on the softkeys to the possible settings for the attribute (for dimmers, a range of values is provided).
- Touch/Clear: places the attribute in the programmer or removes the attribute from the programmer
- Locate: locates the attribute (does not place in programmer)
- Release: releases the attribute

- Off: sets the attribute to Off. This temporarily disables the attribute, though its value is stored and can be restored with On.
- On: sets the attribute to On (when merged to a cue or palette, On will restore a value which has previously been set to Off)
- Freeze/Unfreeze: freeze or unfreeze the attribute

4.1.9 Selecting fixtures and dimmers by number (Channel)

In some situations, for example when programming lots of dimmers, it can be easier to type in the dimmer channels you want to program. The Channel menu allows you to do this for dimmers or fixtures. To access the Channel menu, press the Fixture button on the top left of the numeric keypad. You can also simply start typing numbers on the keypad, when you press Through, And or @ then the Channel menu will be shown.

Through, And and @ are provided as softkey functions or (depending on console) are buttons adjacent to the numeric keypad.

Fixtures may be selected by User Number, Handle Number or DMX Address, as set by the option on Softkey A.

When using the Channel menu it is helpful to latch it by pressing the Menu Latch button.

- To select a fixture, type the number and press Enter.
- To select more than one fixture, press the [And] softkey between each number. For example 1 And 2 And 5 Enter will select 1, 2, 5.
- To select a range of fixtures, press [Through]. For example 1 Through 8 Enter will select 1-8.
- To miss out fixtures in a range, use [Not], for example 1 Through 4 Not 3 Enter will select 1, 2, and 4.
- The @ softkey sets a dimmer level to the selected fixtures, for example 1 Through 8 @ 5 Enter will set 1-8 at 50%. (You can choose whether 50% is entered as "5" or "50" in the User Settings – see section 13.1.3 on page 233). When you press @ there are softkey options for Full, Off and +/- (increase or decrease brightness).
- You can work with Groups using the Group button, for example Group 1 And Group 2 Not 5 Enter will select all fixtures in group 1 and group 2 except for fixture 5.
- You can use the Locate button instead of Enter, to select fixtures and locate them. For example 1 Through 4 Locate will select fixtures 1 to 4 and locate them.

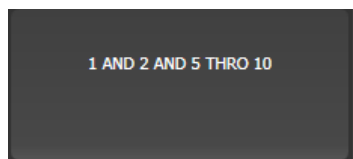

- When entering a command, the command line is shown on the display. You can go back using the grey Back button and you can abandon the line using the grey @ button.

- The AND, THRO and @ functions are also provided on the grey buttons at the bottom of the numeric keypad as printed next to the buttons.

4.1.10 Selecting using a pattern

When programming you will often want to select patterns of fixtures. Rather than having to individually select and deselect fixtures, the Quartz has an easy way of selecting odd then even fixtures in a range of fixtures, or it can, for example, select every 4th fixture.

- 1> *Select some fixtures.*
- 2> *Press the All button (above playback 1).*
- 3> *Select a pattern from the softkeys. Your selection is modified so you will only be controlling, say, the odd fixtures.*



- 4> *Press the Fix + 1 or Fix - 1 buttons button to change the selection to the next stage of the pattern.*
- 5> *To end the pattern selection, press All twice.*

- For example, if you are programming a chase using 16 fixtures and you want every 4th fixture to do the same thing, you just select the 16 fixtures, then press All, then D [1 in 4]. You will see that the 1st, 5th, 9th and 13th fixtures are now selected, and you can create the look for those fixtures. Then press Next, and the 2nd, 6th, 10th and 14th fixtures will be selected ready for programming. After you have programmed the fourth set of fixtures, the pattern will go back to the first position again, until you press All twice to end.
- You can enter your own patterns using the numeric keypad and softkeys, for example "2" A [In] "6".

4.1.11 Selecting fixtures which are in a palette or playback

To select fixtures which are controlled by a particular palette or playback use the Select If function.

To select fixtures used in a playback or palette, press Select If then the palette or playback button. (The Fixture button is at the top left

of the numeric keypad and may be labelled Channel on older consoles.)

You can also use Select If with the @ and Through buttons on the numeric keypad to select fixtures set to a particular intensity.

@X: fixtures set to intensity X

@ Through X: fixtures with intensity 0 – X

@ X Through: fixtures with intensity X – Full

@ X Through Y: fixtures with intensity between X and Y

@@: fixtures with intensity above 0.

Intensity levels may be input as 0-9 or 00-99 depending on the User Setting [Channel Levels Set In] (see section 13.1.3 on page 233).

4.1.12 Attribute groups – IPCGBES-FX

To make life a bit simpler, the console groups together attributes which have similar effects, using the letters IPCGBES-FX.

I-Intensity (dimmer, strobe shutter)

P-Position (pan, tilt)

C-Colour (colour wheel, CMY mixing)

G-Gobo (gobo wheels, gobo rotate, gobo position)

B-Beam (iris, focus, zoom, beam shaper)

E-Effects (prism)

S-Special (motor speeds)

FX-Shapes, Pixel Mapper

These groups are used to select which attributes you want to work with in many of the functions on the console, particularly when you are “masking off” certain attributes from being saved.

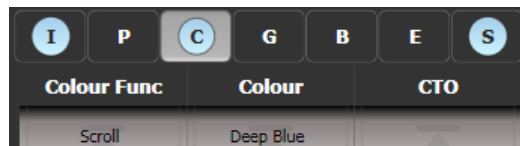

Above the attributes roller on the screen, the console shows you which attribute group you are currently changing (the grey box). The Attribute Group is also highlighted in blue if the programmer contains any of those attributes. For example in the image above we are currently changing Colour attributes, but Intensity and Special attributes have also been modified.

4.1.13 Stepping through selected fixtures one at a time

If you have selected a range of fixtures, or a group, the console has functions to step through the selected fixtures one at a time. This can make it easier to program a range of fixtures because you don't have to select each one manually.

This mode uses the Prev/Next/All/Hilight buttons.

-
- 1> *Select a range of fixtures or a group.*
 - 2> *The Prev and Next buttons will select the fixtures in the range one at a time (in the order you selected them).*

3> *The ALL button will select all fixtures in the programmer (everything which has been selected since Clear was last pressed).*

- The Highlight function can be used to highlight the output of the selected fixture (make it brighter onstage), see the next section.

4.1.14 Highlighting the selected fixture with Prev/Next

When stepping through a fixture selection using the Prev/Next/All buttons, you can highlight the selected fixture on stage. This makes it very easy to see which fixture you are controlling. The other fixtures in the selection go to a dimmed "lowlight" level.

- Press the HiLight button to enable highlight mode. Press HiLight again to disable. When you are in highlight mode, the highlighted attribute is overridden and any changes you make to it are not stored in the programmer (so if the highlight uses intensity, you cannot change the intensity of the fixture).
- You can change the levels used for Highlight/Lowlight by then pressing HiLight, [Store Highlight State] or [Store Lowlight State].

4.1.15 Flash selected fixtures to full

It can be useful when programming to see on stage which fixtures you have got selected. Press the Flash Full button to do this (Avo + Page+1 button). You may also want to turn off selected fixtures, the Flash Out button does this.

4.1.16 Turn off unselected fixtures

To turn off all unselected fixtures use the Remainder Dim function by pressing Rem Dim (Avo+All). The zero intensity is placed in the programmer and will be recorded into any cue. This is useful when removing fixtures from cues.

4.1.17 Align fixtures

You can copy attributes from one fixture to another using the Align Fixtures function. This is very useful, for example, if you've accidentally left a fixture out of a cue you can copy settings from its neighbour.

You can align multiple fixtures to others in one operation, either using groups or individual selection. If you are aligning different numbers of fixtures there are options to set how this is handled, see below.

-
- 1> *Select the fixtures you want to Align either manually or using a group.*
 - 2> *At the top level menu press Fixture Tools/ML Menu then [Align Fixtures].*
 - 3> *Set the mask to include the attribute groups you want to copy (using the Attribute Bank buttons, or using the softkey options for exclude and include all attributes).*

4> *Touch the select button of the fixture or group you want to copy the settings from.*

The fixture selection order is used to determine how the aligned values are copied.

- The [Auto Reset Mask] option will always set the mask to Include All whenever you enter the Align Fixtures function. The alternative option [Remember Mask] will leave the last mask set.
- [Spread Attributes] will try to spread out the attribute changes if there are a different number of fixtures in the source and target groups (best for positions). [Repeat Attributes] will repeat the source selection on extra fixtures, or attempt to mirror the fixtures if there are fewer.
- [Align Programmer Attributes] will only align attributes which are in the programmer, [Align All Attributes] will do everything.
- [Palette References Maintained] will copy palettes from the source fixtures. [Palette References Lost] will convert the palettes to absolute values in the target fixtures.

4.1.18 Flip

Moving head fixtures can point at the same stage position from two possible yoke positions. Sometimes to get the fixture moving the same as other fixtures, you need to swap to the opposite yoke position and the Flip function lets you do that.

1> *Select the fixtures you want to Flip.*
 2> *At the top level menu press Menu Latch then C [Flip Pan and Tilt].*



The settings used for Flip are defined in the fixture personality. If Flip doesn't work you may need to update to the latest personality.

4.1.19 Fan mode

Fan mode automatically spreads out the values on a selected range of fixtures. If used on pan and tilt, the result is spreading out "rays" of light beams. The first and last fixtures of the range are affected most, and the central fixtures are affected least. The amount of fan can be set using the attribute wheels.

As with shapes, the order in which you select the fixtures sets how the fan effect works. The fixtures you select first and last will be the ones which change most. If you use a group to select the fixtures, the order you selected the fixtures when you recorded the group is used.

The fan effect, while normally used on pan or tilt attributes, can be applied to any attribute.

1> *Select the fixtures you want to fan.*
 2> *Press the Fan button.*

- 3> *Select the attribute you want to Fan using the attribute bank buttons.*
 - 4> *Set the amount of fan using the attribute wheels.*
 - 5> *Turn off Fan by pressing the Fan button again when you have finished.*
-

If you have selected fixtures from multiple groups, you can choose whether the fan effect works with or ignores the groups. For example if you have 12 fixtures across the stage in 3 groups of 4, you may want a fan of light beams spread evenly across the stage, or you may want 3 groups of separately fanned light beams.

By holding down the Fan button you can select:

- [Ignore Groups] All fixtures are fanned as one large group
- [Fan Group as Fixture] All fixtures in a group take on the same value.
- [Fan Within Group] Fan runs across individual fixtures in each group.

Holding down the Fan button also allows you to select the Curve used for the fan. The different curves allow you to obtain different fan effects.

Fan mode needs to be used on at least 4 fixtures to give good effects. If you have an odd number of fixtures, the central fixture will not change in fan mode.

Press the Fan button again to leave Fan mode. Any effects you have set will remain in the programmer.



It's all too easy to accidentally leave Fan mode turned on and be very confused about why the wheels aren't working properly, so turn it off as soon as you have completed the effect. To avoid this there is a User Setting 'Press and hold Fan'. If enabled, you have to hold down the Fan button to enable Fan mode. See section 13.1.3 on page 233.

Fan Curves

You can select different curves to use when in Fan mode. Hold down the Fan button and select [Curve], the options are:

- Line: Traditional fan, the first and last selected fixture are affected equally in opposite directions, the midpoint remains unchanged. This is most useful for pan.

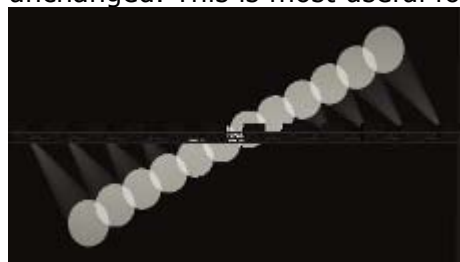

- Pull Middle - The first and last selected fixture remain at the current value, the midpoint is affected most. This is useful for

colour mixing, tilt and dimmer.

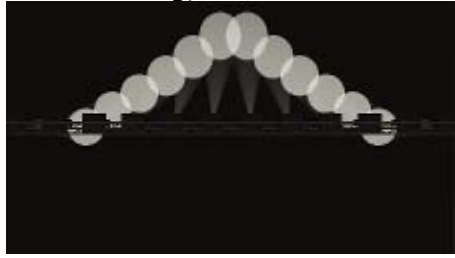

- Pull Ends - The first and last selected fixture are affected most, the midpoint is unchanged. This is useful for colour mixing, tilt and dimmer.



- Arrow - The first and last selected fixture are affected equally to the midpoint fixture but in the opposite direction. This is useful for colour mixing, tilt and dimmer.

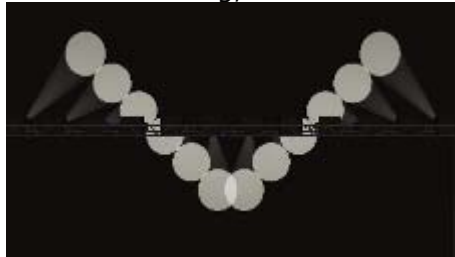

Fan Parts

When using the Fan function you can split the fan into a number of groups. Select all the fixtures, hold down Fan and type a number on the numeric keypad. The Fan will divide into that number of parts, for example:

Normal (1):

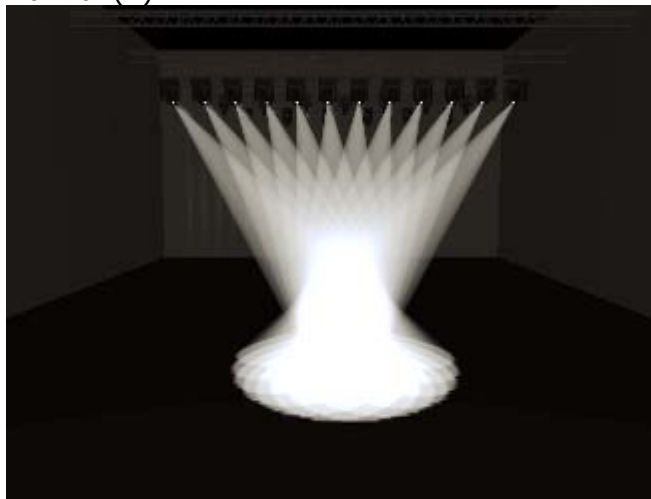

2:

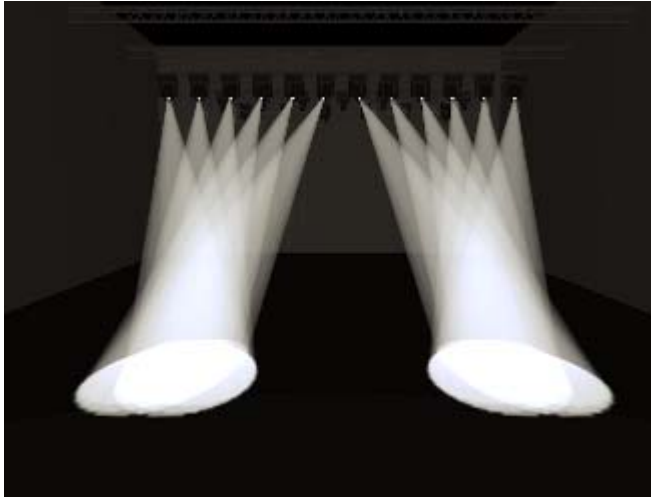

3:

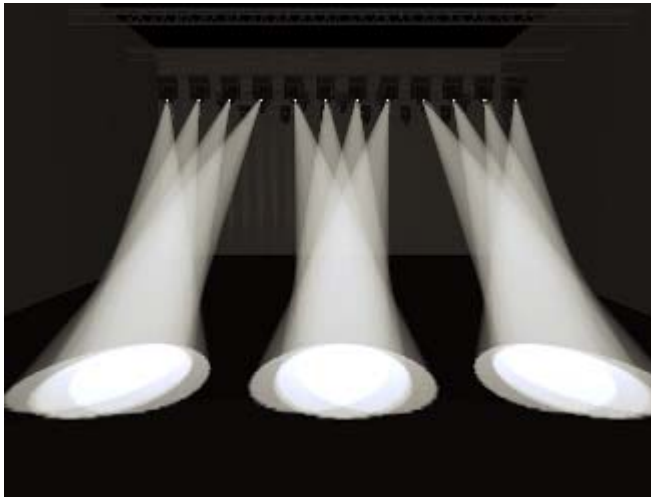

4.1.20 Setting fixture/attribute times

Fade and delay timings can be directly set for each fixture or individual attributes of a fixture. When you store the settings into a cue, the time settings will then become part of the cue.

There are a number of ways to set the times:

- You can set individual attribute times by switching the wheels to Fade Time / Delay Time mode using the [Wheels=] softkey on the root menu.
- Individual attribute times can also be set using a combination of the wheel @ keys and the TIMES key.
- They can also be set by selecting fixtures and entering into the attribute times sub-menus from the TIMES key.
- There is also command syntax that allows various options to set attribute time values - e.g. TIMES FIXTURE Position 5 @ 3 would set a 5s fade, 3s delay time onto the current fixture selection P group. Wheel @ keys can also be used in the syntax. Fan options are also available through syntax using THRO.

Setting a time attribute value will cause the 'in programmer' indication to light up.

The Channel Grid window has a Times context menu button which allows you to view or edit all the attribute times currently in the programmer. You can set a time to Off to temporarily disable it; the On option will restore the previous setting.

You can try out time settings by pressing Avo Shift + Time or double tap the Time button. (previously the SET button on Titan Mobile/Sapphire Touch and the NEXT TIME button on Tiger Touch/Pearl Expert).

4.2 Viewing and editing fixture values

4.2.1 The Channel Grid window

It can sometimes be useful to display and edit exactly what each fixture is doing. The Channel Grid window allows you do to that. Display it by pressing Window Open then [Show workspace window] then [Channel Grid].

Channel Grid												
Attributes	Number	IPCGBES	Dimmer	Shutter	Pan	Tilt	Colour Macros	Colour Func	Colour	CTO	White	
All I	Robin600ES	101	- - - - - F	-	-	58.49	55.22		Fixed	Open	0.0	
P C G	Robin600ES	102	- - - - - F	-	-	36.51	59.01		Fixed	Open	0.0	
B E S	Robin600ES	103	- - - - - F	-	-	63.67	59.08		Fixed	Open	0.0	
Fixture Type	Robin600ES	104	- - - - - F	-	-	44.33	56.06		Fixed	Open	0.0	
All Fixtures	Robin600ES	105	- - - - - F	-	-	66.90	34.02		Fixed	Open	0.0	
Robin 600 LED Wash	Robin600ES	106	- - - - - F	-	-	67.14	37.55		Fixed	Open	0.0	
Robin 600E Spot	Robin600ES	107	- - - - - F	-	-	67.10	64.37		Fixed	Open	0.0	
	Robin600ES	108	- - - - - F	-	-	32.42	34.05		Fixed	Open	0.0	
	Robin600ES	109	- - - - - F	-	-	65.26	35.27		Fixed	Open	0.0	
	Robin600ES	110	- - - - - F	-	-	39.41	42.83		Fixed	Open	0.0	
	Robin600ES	111	- - - - - F	-	-	60.06	42.83		Fixed	Open	0.0	
	Robin600ES	112	- - - - - F	-	-	35.03	37.34		Fixed	Open	0.0	

The window can be set to different modes using the context buttons to the left of the menu. The modes are:

- Playbacks: shows which playback is controlling each attribute of each fixture
- Levels: shows the output levels of each attribute. These may be shown numerically or as range names.
- Palettes: shows which palettes are allocated to fixture attributes
- Shapes: shows which shapes are running on fixtures
- Output/Programmer: switches between the attributes on the console output, and the attributes currently in the programmer
- Highlight off/changes: if set to [Highlight changes] then changing attributes will be highlighted.
- Narrow/Wide columns: changes the column width on the screen.
- Stage: shows only fixtures with intensity above zero

- Selected: shows only selected fixtures

You can **select** fixtures by touching the fixture names on the left of the screen, or if you select any fixture values, the appropriate fixture will automatically be selected.

You can **clear** attributes in the channel grid by selecting them (touch or touch and drag to select multiple attributes). Then press Clear.

You can **edit values** by selecting one or more values in the grid, then modify the values using the wheels, or type a new value on the numeric keypad and press Enter.

You can filter what is shown in the grid either by IPCGBES attribute (using the buttons top left) or by fixture type (using the buttons below that).

4.2.2 Intensity window

If you want to see at a glance the intensity setting of each fixture, the Intensity window is the place to be. To show the window, press [Show workspace window] then [Intensity].

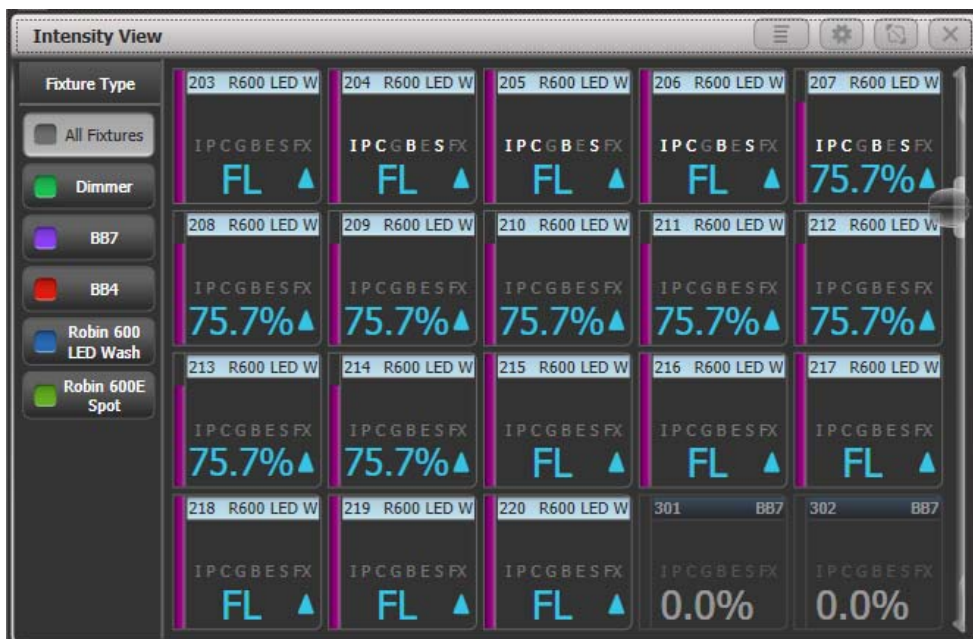

Each fixture has a block showing the intensity as a number and as a bar down the left side. The header bar shows selection/programmer state like fixture buttons – blue for selected and cyan for in programmer.

Rising or falling intensity is shown with a blue up arrow or a green down arrow.

Tracked values from previous cues are shown with a magenta equals sign.

In a solo or block cue a red “not permitted” symbol is shown.



If intensity levels are controlled by an effect they are shown in yellow with a tilde symbol (~).

If the intensity is controlled from a cue or cue list the name of the cue will be shown.

The IPCGBESFX states of the fixture are also highlighted if any attributes have been set in the programmer.

If colour halos are set for the fixture buttons, the halo is also displayed around the fixture intensity. This option can be changed to show the automatic fixture colours, see below.

- Filter the view to show only a certain type of fixture using the buttons on the left
- Change the display order of the fixtures using the [Sort] context menu buttons – User Number, Last Selected or DMX Address.
- Click on a fixture to select it, you can then edit the intensity directly.
- Press Window Open followed by a fixture button to show more detailed information about the fixture.

The context menu options give you settings to change how the window is displayed.

The first option lets you only show fixtures in a particular state:

All – all fixtures (default)

Stage – fixtures with intensity above zero

Programmer – fixtures in the programmer

Selected – fixtures which are selected

Live cues – only intensities coming from active cues

Connected cue – only fixtures in the currently connected cue (for cue lists or chases)

Frozen – fixtures with frozen intensity

The second option changes sort order as described above

[Search] allows you to enter characters to search for in the legend or user number, matching fixtures will be shown as you type. When Search is active a search bar is shown at the top of the window, click the X to remove the search filter or click on the text to modify the search string.

[View If] lets you click on a group and/or playback to show only the fixtures in that group or playback. For a chase or cue list, this will include all fixtures in all the cues of the chase/list. The filter settings are shown in a bar at the top of the window, click the X to remove the filter or click on the bar to change the group/playback.

[Open Channel Grid] opens the Channel Grid window described in the previous section.

In the **Window Appearance Settings** (cog button) there are further display options. Turning off some of the options will reduce the size of each fixture button which may be useful if you want to get more fixtures on the screen.

- Filter Fixtures Shown/Hidden: Shows or hides the fixture selection buttons on the left

- User Number Hidden/User Number Shown/DMX Address Shown: Sets what information is shown in the top left corner of the button
- Legend Shown/Hidden: Sets whether the fixture legend is shown in the top bar
- Cue Information Shown/Hidden: Sets whether the button shows the current cue information
- Attribute Mask Shown/Hidden: Sets whether the button shows the IPCGBESFX settings
- Halo Colour Custom/Auto: If set to Custom, buttons will have a halo colour if you have set one, otherwise they will not have a halo. If set to Auto, buttons will be coloured using the automatic fixture type colour used in the filter buttons on the left.
- Fixture Cells Shown/Hidden: If set to Shown, separate buttons are shown for cells (sub-fixtures) of any multi-celled fixture, along with a master intensity.
- Tracked Fixtures Shown/Hidden: (This option only appears when the view is filtered to Live Cue or Connected Cue). Sets whether fixtures with tracked intensity are shown or not.

4.3 Fixture groups

4.3.1 Using fixture groups

You can create groups of fixtures or dimmer channels, which can then be quickly selected together by pressing a single button or typing the group number. You can, for example, make a group for each type of fixture, then also group by stage left / stage right, etc.

If you have a lot of fixtures, clever use of groups will greatly increase your programming speed.

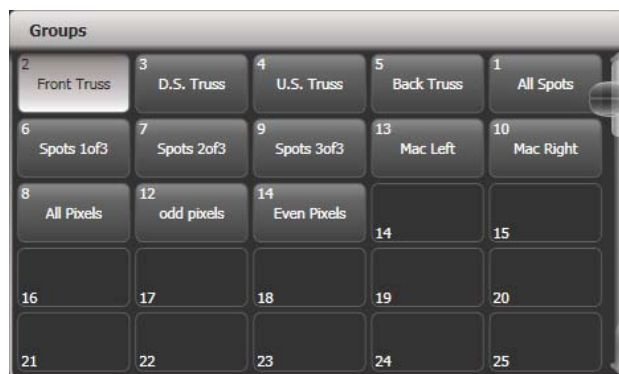

Groups can be stored in the Groups window, on the grey button of fader handles or on Macro/Executor buttons.

If you assign a group to a handle with a fader, the fader becomes an intensity master for the group. See section 11.1.5 on page 212 for more details.

If the Groups window is not visible, you can show it by pressing Window Open, Group (above numeric keys).

-
- 1 > *Select the fixtures/dimmers you want in the group (the order in which you select them will also be stored in the group).*

- 2> Press the grey Group button (top right of the numeric keys) then [Record Group]. You can also press Record then the Group button.
- 3> Use softkey A to enter a number for the group, or B [Provide a legend] to set a legend.
- 4> Touch an empty Group button, or press the grey button of a fader handle where you want to store the group, or press C [Store] to store as a numbered group.
- 5> Press Clear then repeat from 1 to store other groups.

- You can also press the Avo button and the Group button to go directly to the Record Group menu, or on the screen touch the button twice to use Quick Record – on the first touch the button will turn red with a +, on the second touch the group will be recorded.



- To select all the fixtures/dimmers in a group, just press the button for the group.
- The order in which you originally selected the fixtures when creating the group is also stored. This takes effect when you use the last fixture – next fixture functions described in the next section, and when you use Shapes, Fan mode and Fixture Overlap functions. You can change this later, see the next section.
You can override the selection order while recalling a group by holding down the group button and using the softkey options.
- You can also recall a group by its number:

- 1> Press the grey Group button.
- 2> Type in the number of the group you want to recall.
- 3> Press [Recall Group].

- The Group button also gives you facilities on the softkeys to edit and delete groups.

Auto Groups

When patching multiple fixtures, the console automatically creates groups for you. A fixture type group is created which contains all fixtures of the same type (for example, [All Mac 2000]). Another group is created each time you patch a quantity of fixtures (for example, [4 BB4].) This function can be turned off using [Auto Groups] in the User Settings.

4.3.2 Fixture Order and Fixture Layout in groups

Fixtures in a group are stored with a selection order, which is used with Shapes, Fan, and Overlap. You can also store a 2D position layout for fixtures, giving the actual physical location of fixtures for use with the Pixel Mapper effects.

To change fixture order:

- 1> Press [Edit Times].
- 2> Select the group you want to edit.

3> Press [Fixture Order].

The fixtures in the group will be shown numbered in the fixtures window.

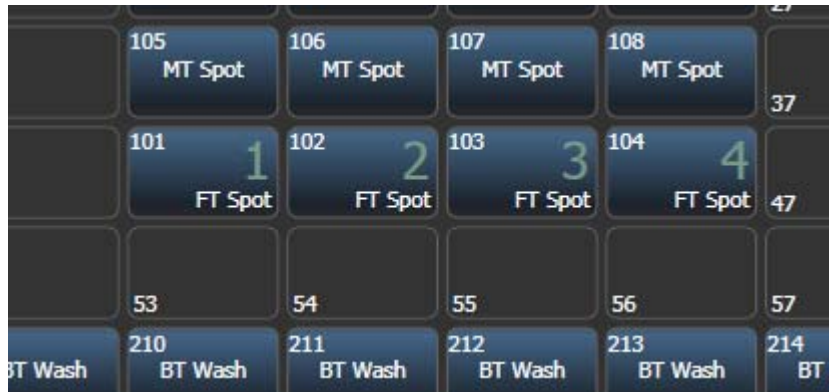

To change the order, select [Auto Increment] to On, then select the fixtures in the order you want. If you press a fixture twice, it will show an X indicating that it is not part of the sequence.

To change fixture layout:

-
- 1> Press [Edit Times]
 2> Select the group you want to edit.
 3> Press [Edit Layout]. The Layout Editor window will open.
-

Initially fixtures will be all in a row. You can reposition the fixtures anywhere on the screen by dragging them. Or press a fixture to select then use the wheels to move it around the grid. You can resize the grid by dragging the bottom or right sides.

The [Arrange Fixtures] context command will automatically place the fixtures in a rectangular block, you specify the number of rows (Height) and columns (Width).

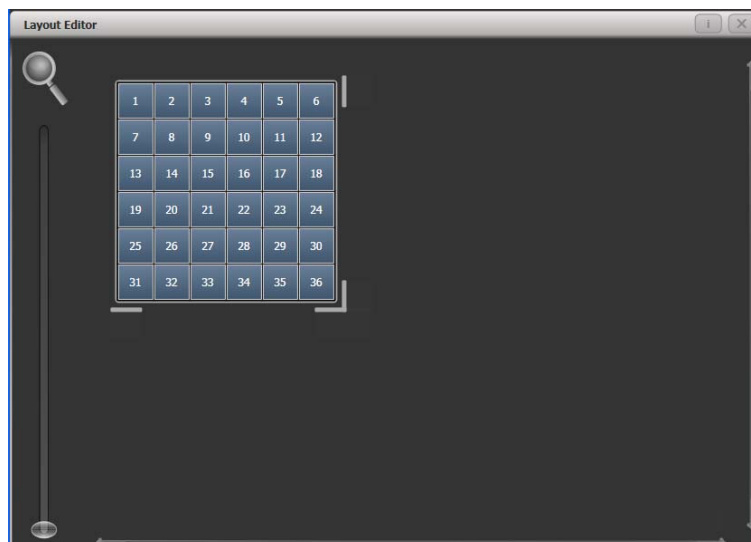

- The X-coordinate of the fixture layout is the same as the Fixture Order. Changing one will cause the other to change.
- It is possible to accidentally overlay one fixture on another, making the bottom fixture hidden. To access overlaid fixtures, drag off the fixture which is hiding it, or select the hidden fixture and use the wheels to move it somewhere visible.

- You can use the Fan button to evenly spread fixtures in the layout.
- The Layout Editor is described in more detail with examples in the Pixel Mapper section 6.6.4 on page 137.



You can randomize the fixture order when selecting fixtures using a group by holding the group button and pressing [Random Order].

4.4 Advanced options

4.4.1 The ML Menu button

When the console is at the top level menu, this button opens the Moving Light Actions menu which contains options to Locate Fixture (same as the Locate button) and to run Macros on fixtures such as Lamp On, Lamp Off, Reset etc. The Align Fixtures and Flip functions as described above are also in this menu.

On the Pearl Expert and Tiger Touch Mk1, this button also latches the current menu when the console is not at the top level menu. Press Exit to get back to the top menu so that you can access the Moving Light menu. On other consoles there is a dedicated Latch Menu button.

4.4.2 Lamping fixtures on and off

Many fixtures have a control channel which allows you to perform functions like lamp on, lamp off, fixture reset, and so on. This can be useful to shut down fixture lamps at the end of a show while the fans continue to run, or to reset a fixture which has gone haywire.

The console allows you to access these functions using Fixture Macros (not to be confused with keypress macros).

-
- 1> *Keep pressing Exit until you are at the top level menu.*
 - 2> *Select the fixtures you wish to control. Macros may not work across groups of fixtures from different manufacturers so it's best to do each type of fixture separately.*
 - 3> *Press Fixture Tools/ML Menu then [Macros].*
 - 4> *The softkeys show a list of the functions available. Press the one you want to action.*
-

- Some macros involve timed sequences and can take up to 30 seconds to execute.

5. Palettes

When programming a show you will find that you frequently use certain positions, colours, etc. The console lets you store these settings so you can recall them at the touch of a button rather than having to find them on the wheels every time. This is very useful for rapid programming and when busking a show.

When you use a palette to record a cue, the console stores a reference to the palette, rather than the actual value. This means that if you program your cues using palettes, you can easily change all the positions in your show just by reprogramming a few palette entries rather than having to reprogram all the cues. This is handy if you are touring and have to cope with different stages or truss heights every show.

Palettes can be nested so you can use palettes in other palettes. If you change a master palette, the changes will track through to all the palettes in which it is used.

Palettes are stored and selected using the buttons in the Colours, Gobos/Beams and Positions windows. You can also store palettes on the grey buttons of fader handles and on Macro/Executor buttons. You can set a legend for each button so that you know what you're going to get.



If the Colours, Positions, Gobos & Beams windows are not shown, press Window Open then [Open Workspace Window] then [Groups and Palettes] to show all three windows.

5.1 Creating palettes

5.1.1 Which attributes are stored in palettes

Although each palette entry could store all attributes of a fixture, it's easier to operate the console if you create some palettes which only set positions, some for colour, some for gobo and so on. The console helps you with this by providing separate windows for Colour palettes, Position palettes, and Gobo/Beam palettes.

When you store a palette, it will only contain what's in the programmer (the attributes you have changed since you last pressed Clear). For example to create a colour palette you would just set the colour, and not change any other attribute. You can also make palettes which contain effects such as shapes and pixel mapping. If fade or delay times are programmed for fixtures or attributes, these will also be stored in the palette, and you can also create palettes which contain only time information.

If the programmer contains more than one attribute, you can set a mask to restrict which fixture attributes will be stored in the palette.

Palette information may be **Global**, **Shared** or **Normal**. Global palettes work on any type of fixture. Shared palettes apply the same value to all fixtures of the same type – for example when setting colours, the "Red" palette would set the same colour values for "Red" to all MAC 2000 fixtures. Normal palettes are used when each fixture requires its own value - for example when programming positions, each fixture will have a different setting.

It is possible, by merging information into palettes, to create a palette which contains global, shared and normal attributes.

Available attributes for Global palettes are Dimmer, Pan, Tilt and Colour. When creating a global palette for a colour mixing fixture, both CMY and RGB attributes are calculated and a special "dynamic" value is added to colour wheel channels, the console will attempt to match the closest fixed colour wheel colour to the selected mix colour.

5.1.2 Storing a palette

This is how you save a palette value:

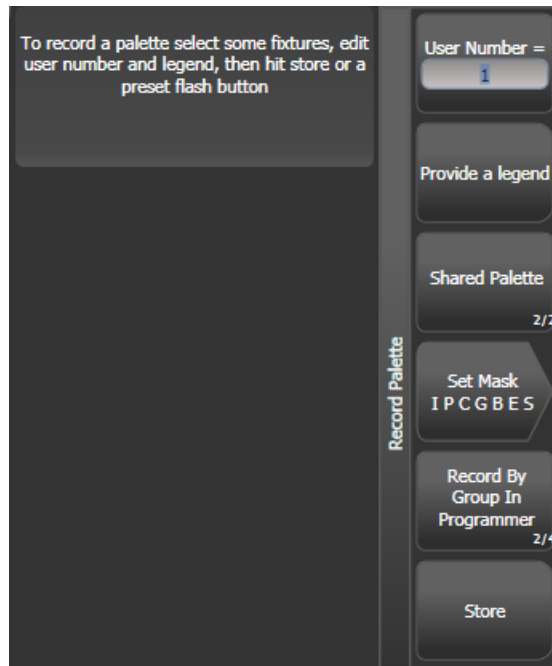

- 1> Press Clear to clear the programmer.
- 2> Select the fixtures for which you want to store palette values.
- 3> Using the attribute buttons and wheels, set the attributes you want in the palette entry. You can store any or all attributes of a fixture in each palette entry.
- 4> Press the Palette button, then [Record Palette]. Using Quick Record (see next section) you can skip this step.
- 5> Set the palette Mask – this sets which attributes will be recorded in the palette. Select attributes using the Attribute Bank buttons – anything lit up will be saved. [Set Mask] and [Record by] softkeys also control the Mask (see below).
- 6> Press an unused Palette button to store the palette (available buttons will flash). Or enter a palette number and press [Store]

- The console will automatically set the palette as Global, Shared or Normal (by checking if the values to be stored are the same across all fixtures of the same type). You can override the setting by pressing softkey C. See below for more details of how this automatic choice works.
- [Set Mask] allows you to specify which attribute groups will be included in the palette. You can also use the grey Attribute Bank buttons on the right hand edge of the console to set the mask.
An attribute group is included when the softkey is inverted (like the Colour group in the picture) and when the LED is lit on the Attribute Bank button. If you use Quick Record (see next section) the mask is automatically set by the workspace window you save the palette in – Positions only includes P, Colours only C and Beams includes IGBES. If you use the Record Palette button then you need to set the mask manually.
- Press the Attribute Options button to toggle each mask group between Include and Exclude.

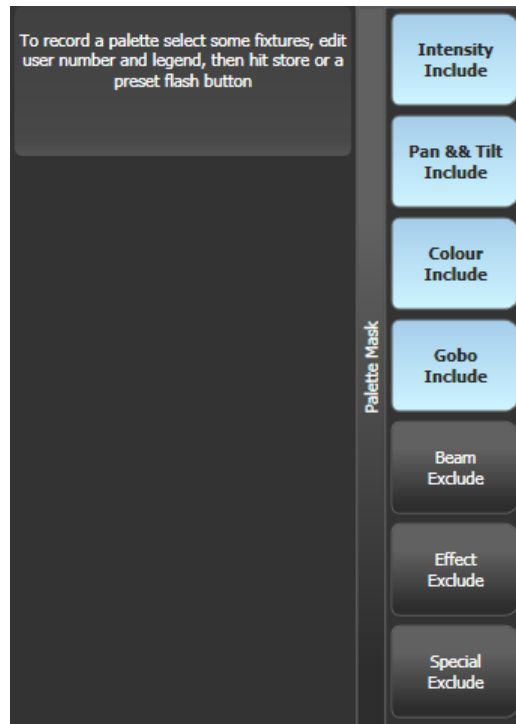

- [Record By...] allows you to control how the mask is used when saving the palette. The options are:
 [Channel in programmer] records only channels which are in the programmer (ones which you have changed)
 [Group in programmer] records all channels in any attribute group which has one or more channels in the programmer. For example if Cyan is in the programmer, all colour channel settings will be recorded even if not in the programmer.
 [Group in mask] records everything included by the mask set on the attribute buttons
 [Mixed] records by attribute group for Position and Colour but by channel for all other controls.
- The console will automatically create a legend for your palette (unless the User Setting [Auto Legend] is set to Off). For colour palettes a coloured icon is used to show the selected colour. If the palette contains fixtures set to different colours, a coloured bar will be shown for each. For CITP (media server) palettes, the media thumbnail will be used. For other attributes the last adjusted function value will be used for the legend, except for pan and tilt which will use a default legend.



- You can also manually set a legend for the palette while you are saving it using [Provide a legend]. See section 5.1.5 for how to change the palette legend.
- If you select a Palette button which is already used, the console offers you options to [Cancel], [Replace] or [Merge] the existing palette. [Replace] will erase the palette and save only the latest changes you have made. [Merge] will combine your changes with the palette. This allows you to add settings for additional types of fixtures to a shared palette or to update the existing

fixture settings. Pressing the palette button again will automatically merge. The palettes are merged using Quick Merge, which has a mask to include or exclude attribute types.

- The console will select Global mode if the programmer contains the same values for all selected fixtures and one or more of the attributes is suitable for Global. If the values are the same but none of the attributes are suitable for Global the console will select Shared. If some attributes are suitable and some aren't, the console will record the suitable ones as Global and the others as Shared. If the values are different the console will select Normal.

5.1.3 Nested palettes

Palettes can contain references from other palettes. For example an odd/even colour palette could be created using two other colour palettes as the masters. If you wanted to change the colours, changing the master colour palettes would also change the odd/even colours.

The [Record/Don't Record Nested Palettes] option in the Record Palette menu sets whether nested palettes are recorded (default) or whether the attribute values are recorded instead.

When palettes are used in cues, you can disable the nested palettes using the playback option [Fire/Don't Fire Nested Palettes]. If set to Don't Fire, the nested palettes are treated as the fixed values they held at the time the cue was recorded and won't change if the nested palette is updated.

5.1.4 Quick record

The palette windows allow you to quickly record a new palette. Just touch the button where you want to record – the button will turn red with a + sign. At this point you can enter a legend for the new palette or change mask settings. A second press on the button will save the palette.



- When using Quick Record, the palette mask is automatically set to match the window, so if you touch a button in the Position window, the mask will be set to only store position attributes. This does not happen if you use the Record Palette button.

Quick record also works for groups, workspaces and the playback window.



If you are loading a show which was programmed on a Pearl Expert, you can use the Groups and Palettes workspace window to access the fixtures/palettes on the blue/grey preset buttons on the Pearl. See section 13.2.5 on page 282 for more details.

5.1.5 Setting legends for palettes

You can enter a legend for each palette which is displayed on the palette touch button.

- 1> Press [Set Legend] at the top level menu.
- 2> Press the palette button for the palette you want to legend.
- 3> Type the legend on the keyboard.
- 4> Press Enter when you have finished.

- On touch buttons, the palette number is shown top left. The IPCGBES attribute groups contained in the palette are displayed below your legend, so for example Position palettes will show a P, colour palettes a C and so on. In the top right corner is shown G for Global, N for Normal or S for Shared palette.

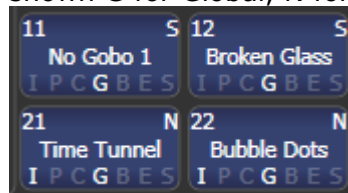

You can create a picture legend for your palette which could for example represent the colour or gobo it will create. After pressing [Set Legend] and the palette button, press [Picture]. The picture editor will open.

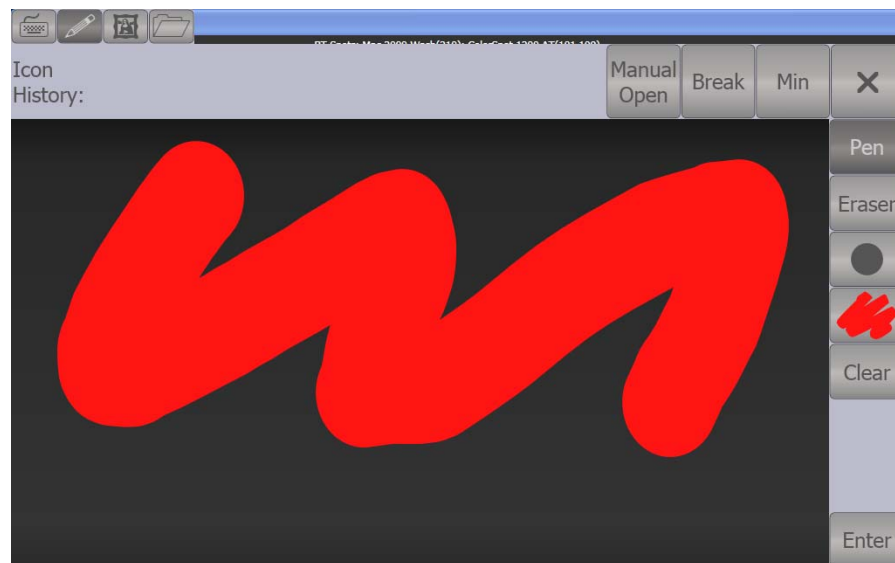

The tab buttons on the top left allow you to select Keyboard entry (legend reverts to text), Draw, Icon Library, or Load File. On the right you can choose Pen or Eraser, set the pen/eraser size, set the colour (white in the above picture), clear the whole picture, and Enter the legend. The Min button top left reduces the editor to a smaller size.

If you select Library you can choose a picture from a wide range of pre-programmed pictures. The pictures are sorted into various folders which are listed on the left.



5.1.6 Creating an effects palette (shape or pixel mapper)

Speed up your programming by creating some palettes which apply shapes or pixel mapping effects. You can't save a keyframe shape to a palette.

For an effects palette to be useful, it needs to contain only effect settings (for example, for a pan/tilt circle you want it to move the fixtures around their current set position, not to change the position as well). To achieve this you can either use the FX mask when saving the palette, or you can just remember not to set any other values when programming.

-
- 1> Press Clear, select some fixtures and locate them. If you need to move them so you can see what's happening, you can do that too.
 - 2> Press [Shapes and Effects], [Shape Generator] and choose a shape to start (see section on page for more information about shapes).
 - 3> Alter the parameters of the shape as you require.
 - 4> Press Palette, [Record Palette].
 - 5> If you moved the fixtures in step 1, press [Set Mask] and exclude everything except FX.
 - 6> Press a palette button to store the shape palette.
-

5.1.7 Creating a time palette

You can create palettes which contain only time information. These can be used to set cue times and fixture attribute times without needing to set times manually. Using a time palette also means that you can go back and change the times once in the palette, and the changes will automatically apply to all cues which use the palette.

-
- 1> Press Clear, select some fixtures and locate them. If you need to move them so you can see what's happening, you can do that too.
 - 2> Press Time (may be labelled Set on Mobile/Sapphire/Quartz, and Next Time on Expert/Tiger).
 - 3> Change Fade time to 2 sec. This sets the global fade time into the programmer.

- 4> Press Palette, [Record Palette].
 - 5> If you moved the fixtures in step 1, press [Set Mask] and exclude everything except Time.
 - 6> Press a palette button to store the Time palette.
-

5.2 Recalling palettes

5.2.1 Recalling a palette value

To recall a palette value from a button, this is what you do:

- 1> Select the fixtures to be changed. Shared palettes can be set to any fixture of the same type. Normal palettes will set individual values to each fixture. If no fixtures are selected, the palette will apply to all fixtures it is relevant to.
 - 2> Press the Palette button you want to recall. The palette will be set to the selected fixtures.
-

- You can make palettes fade over a time when you recall them, see section 0 below.
- When a palette is used in the programmer, the touch button will light up to indicate this (you can disable this in the User Settings). This makes it easier to see which palette you have selected.



You can also recall a palette by its number by typing the number on the numeric keypad.

- 1> Select some fixtures.
 - 2> Press the Palette button above the numeric keypad.
 - 3> Type in the number of the palette you want to recall.
 - 4> Press Enter or [Apply Palette].
-

- The [Apply Palette] softkey shows the legend of the palette which will be applied.

5.2.2 Palette pages

Each of the palette windows can either display pages of palettes, with page buttons on the left, or a continuous scrolling window of palettes. To change between pages and scrolling, touch the Pages Show/Hide button in the context button area to the left of the menu buttons. using the page buttons to the left of the palette buttons.

- You can recall a palette from any page using its number as described in the previous section.

5.2.3 Only showing relevant palettes

If the User Setting [Filter Relevant Palettes] is enabled, when you select fixtures any palettes which are not applicable will grey out. This is very useful to see which palettes are available for the fixtures you are working with.

5.2.4 Quick palettes with no fixtures selected

If you press a palette button when no fixtures are selected, the palette will be set to all the fixtures the palette applies to. This is called a Quick Palette. For example if you've got some colour palettes programmed for your MAC 2000's, pressing one of the palettes when no MAC 2000's are selected will set the colour to all the MAC 2000's.

5.2.5 Setting palettes to all fixtures in a playback

You can apply a palette to all fixtures in a particular playback. Hold the palette button and press the select button of the playback which the palette is to apply to.

5.3 Editing palettes

5.3.1 Viewing and editing the content of palettes

You can view the contents of a palette in the Palette View window. This lists all fixtures in the palette and the attribute values stored for them. A context menu button allows you to switch to displaying Times.

Press Window Open, then the palette button. The Palette View window will open.

Attributes		Number	Order	Colour Macros	Colour Func	Colour	White	CTO	Cyan	Red	Magenta	Green	Yellow	Blue	CMY Macros
All	I	BB7	-	1						100		0		0	
P	C	BB4	-	1						100		0		0	
B	E	R600 LED W	-	1	Open		0	0		100		0		0	
	S	Robin600ES	-	1		Fixed	Open		0	0		100		100	Open

Fixture Type

- All Fixtures
- BB7
- BB4
- Robin 600 LED Wash
- Robin 600E Spot

You can filter which attributes are shown using the All/PCGBES buttons in the top corner, or which fixtures are shown using the fixture type buttons below that.

To edit an attribute value, touch/click on it in the window. The softkeys will give you a list of available settings for this attribute or you can type in a numerical value.

There is also a [Delete] button which allows you to remove the value from the attribute. This is the same as using the Off function.

- When the palette contains other palettes, the context menu option [View/Hide Nested Palettes] sets whether or not the view shows the actual attribute value or just the name of the nested palette.
- When the palette contains shapes, the context menu option [View Shapes] will open the Shape View showing all the shapes with their parameter. Clicking View will open the Shape Fixture View which lets you edit the fixtures running the shape; the Add Fixtures menu button will add selected fixtures into the shape.
- When the palette contains effects (Pixel Mapper) the context menu option [View Effects] will open the Effect View window to let you edit the effect.

5.3.2 Changing the content of palettes

To edit a palette entry, press the Update Palette button, select the palette to edit (this will automatically select the fixtures used in the palette), make the changes you want, then press the [Update Palette x] softkey to save the changes.

The Update Palette button also allows you to change the palette name and number.

You can also load the palette into some fixtures, modify the attributes and record the new information back on top of the existing palette entry. The console will give you options on the softkeys to Replace, Merge or Quick Merge the palettes. If you select Merge, anything you haven't changed will not be affected, values you have changed or added will be amended. Quick Merge will only update the attributes stored in the original palette and ignore others (for example if you are merging with a position palette, but have also modified the colour attributes, the colour attributes would not be merged in).

When double clicking a palette button to update, the default option is Quick Merge.

- You can set the console to "Always Merge" (so it doesn't ask you) using the User Settings (hold down the Avo button to set these). You can also press the palette button a second time to select the Merge option.
- You can add additional fixtures to a palette without affecting existing ones. For example, if you have colour palettes for Mac 600s, you can add colours for your Mac 500s without affecting any previously recorded values in the palette.
- You can remove attributes from palettes using the Off function, see section 7.3.5 on page 160.
- When editing a palette the state of the programmer will be preserved; when the modified palette is saved, your original programmer contents will be restored and the programmer will be left in the same state as when you started editing the palette.

5.3.3 Updating palettes used in a playback

If you need to quickly update a palette during a show, for example you fire a green cue and the Green palette used turns out to be not

quite the right colour, the Update function lets you automatically update the palette used in the cue.

-
- 1> *With the cue fired, select the fixtures and change them to the settings you want to store (e.g. the right green colour).*
 - 2> *Press Update.*
 - 3> *The cues and palettes which can be updated are shown on the softkeys and all other buttons are greyed out.*
 - 4> *Press the palette button (for example, Green) twice to update that palette.*
-

- You can also select multiple palettes to be updated by highlighting them in the softkeys then pressing Enter to confirm.

5.4 Copying, moving and deleting palettes

5.4.1 Copying or moving a palette

Using the Copy button you can make a copy of an existing palette or move it to a new button. You can copy or move multiple palettes in one operation. You cannot link palette buttons.

Move is useful for tidying up the console.

-
- 1> *Press the Copy button.*
 - 2> *Select [Copy] or [Move]. Pressing the Copy/Move/Link button again will also toggle these options.*
 - 3> *Press the Select button of the palette you want to copy/move. You can select multiple palettes.*
 - 4> *Press the empty button where you want it to go.*
-

- The Menu Latch button latches the Copy/Move/Link menu, so you can keep copying, moving or linking things without having to keep pressing the Copy button. Press Exit to unlatch.
- [Retain Layout] or [Bunch Up] is used when copying a group of palettes with empty handles in the group – you can either keep the empty handles, or bunch up the used handles together.
- When in Copy mode, option [Copy Legends] can be changed to [Don't copy legends] so that the copied palettes are given default legends.
- When in Move mode, [Swap Items if Required] will attempt to reposition any existing handles which are in the way of the move. This is useful when rearranging buttons on a page which is nearly full.

5.4.2 Deleting palettes

You can delete a palette entry by pressing the Delete button, then pressing the palette select button to be deleted. Press the palette button again to confirm the deletion. For palettes stored on physical buttons you can delete a range of palettes in one go by holding down the first one while pressing the last one.

Other ways to delete a palette:

- Press the Update Palette button, select a palette, use the [Delete] softkey option.
- Press the Palette button above the numeric keypad and use the [Delete] option in the [Palette Utilities] menu.
- Press Delete then [Palette], type the palette number, press Enter.
- If you have playbacks which use the deleted palette, they will go back to the values which were stored in the programmer when the playback was recorded.

5.5 Timing with palettes

Palettes may be saved with timing information, or you can manually override the timing when recalling the palette.

5.5.1 Palettes with saved times

If you have saved time information in a palette, it will normally recall with this timing information. So if you programmed a 2 second fade, the palette will recall with a 2 second fade.

You can turn this off (which can be useful during programming) using the key profile setting for palette keys (see section 13.4.1 on page 242). You can set [Palette Is Fired With Its Times] or [Palette Is Fired Ignoring Its Times].

5.5.2 Manually overriding palette times

Being able to recall palettes with a manual fade allows easy "busking" of shows. When a palette is recalled in this way, a time is added and the palette fades in over that time.

-
- 1> *Select some fixtures.*
 - 2> *Type in the fade time for the palette on the numeric keypad.*
 - 3> *Press a palette button to recall the palette.*
-

- This overrides any timing stored in the palette itself.
- You have to re-enter the time each time you recall a palette. To use the same fade every time, set a Master Time: Press Palette, [Master Time]. To disable Master Time set to 0.
- Palette fading can be very useful when recalling a palette live during a show, as you can smoothly move fixtures to a new position or change colour slowly (on colour mixing fixtures).
- Palettes applied with a fade time do not get put into the programmer, so will not be saved in any cues; don't use fade times when programming. This is to ensure that when used in a live situation, the next cue will override the palette and play back as intended.

5.5.3 Manual fixture overlap when recalling palettes

You can set a Fixture Overlap when recalling a palette, which means that the palette will be applied in sequence to each fixture in the group. This is a very quick way to busk some amazing effects. Fixture Overlap=100% means that all fixtures will change together. Fixture

Overlap=0% means that each fixture must complete its fade before the next will start its fade.

-
- 1> *Type in the overlap time for the palette on the numeric keypad.*
 - 2> *Press [Set Overlap].*
 - 3> *Type in the fade time if fade is also required.*
 - 4> *Press a palette button to recall the palette.*
-

- You have to re-enter the overlap each time you recall a palette. To use the same overlap every time, set a Master Overlap: Press Palette, [Master Overlap]. To disable Master Overlap set to 100%.

5.5.4 Master Time for palettes

Option [Master Time] on the Palette menu (press the grey Palette button above the numeric keypad) allows you to set a default fade time. This fade time will be used for all palettes unless you manually type in a different time. This can be useful when "busking" a show with palettes.

The [Master Overlap] option similarly sets the default Overlap for palette recall.



You can create macro buttons to set different palette fade times. Press Macro, Record, press a button to store your macro on. Then press Palette, [Master Time], 3 (for 3 sec), Exit, Macro.

Repeat these steps to create a Palette Snap button (0 sec), or a 1 sec fade button, and so on.

6. Shapes and Pixel Mapper effects

The Shape Generator in the Quartz (sometimes known as an Effects Generator on other consoles) allows you to quickly create exciting light shows using lots of movement and changes, with the minimum of programming.

You can use the conventional Shape Generator with preset patterns, or the Key frame Shape Generator which allows you to create your own custom patterns.

The Pixel Mapper is used to generate animated textures using the colour or intensity of a group of fixtures (often LED battens, starcloths or LED web type fixtures). When viewed at a distance the effect becomes clearly visible.

6.1 Shape generator

A shape is simply an automatic sequence of values which modify a particular attribute of a fixture. A circle shape, for example, applied to the pan and tilt attributes, would cause the fixture to move its beam in a circular pattern around its current position. You can set the size of the circle and the speed of the circle movement.

In addition to position shapes, there are a large number of other shapes available in the Quartz . The shapes are defined for a particular attribute such as colour, dimmer, focus and so on.

A further category of shapes is the Block Shape. This type of shape blocks out other shapes, preventing them from running. For example, if some fixtures are running a Circle shape, and then a playback is fired which has a Block Pan/Tilt shape on some of the fixtures, those fixtures will stop running the circle shape. This can be very useful to modify playbacks at showtime when used with the playback priority feature (see section 7.6.1 on page 167).

When you use a shape with more than one fixture, you can choose to either apply the shape identically to all the fixtures, or offset them so that the shape runs along the fixtures creating "wave" or "ballyhoo" type effects. This is called the *Phase* of the shape.

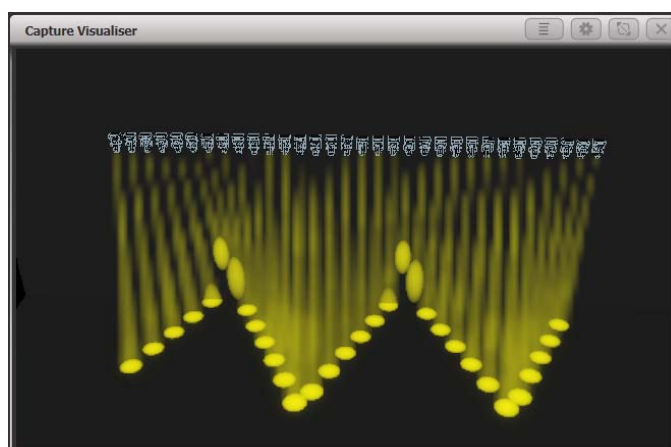

6.1.1 Selecting a shape

To run a shape, select some fixtures, pick the attribute of the shape from a list on the softkeys, then choose the shape you want from the Shapes window. Shapes are organised using the IPCGBES attribute groups, so you can pick from a list of Dimmer shapes, or a list of Pan/Tilt shapes, or Colour shapes, and so on. You can also pick from a list of All Shapes.



When you create a shape, it will be applied to all selected fixtures.

-
- 1> *Select the fixtures the shape is to be applied to.*
 - 2> *At the main menu press [Shapes and Effects] then [Shape Generator].*
 - 3> *Press [Create] to start a new shape.*
 - 4> *Press a softkey to select the attribute type to use in the shape or press [All shapes] for a full list.*
 - 5> *Press a softkey to select a shape, or touch the desired shape in the Shapes window. You can type a search word on the keyboard to search for a particular shape.*
 - 6> *The shape will be applied to all selected fixtures.*
-

- If you open the Shapes window, it will remain open for instant selection of shapes (you don't need to select [Shape Generator]). The window will only show shapes which are possible on the selected fixtures. Pressing attribute buttons will filter the Shapes window to show only shapes for that attribute. Press the Dimmer attribute button to show all shapes.



- Shapes are based on the current settings of the fixture, so a position circle would move around the current pan-tilt position of the fixture.
- You can change the base value of a shape (e.g. the centre of a circle) by changing the attributes using the wheels in the usual way. You can reduce the Size to zero (see next section) to help you see what the base value actually is.
- You can run more than one shape at a time by repeating the above procedure. You can run several shapes on one fixture and the output will combine in interesting ways.
- Press [Shapes and Effects], [Shape Generator] then [Edit] to show what shapes are running.
- If you apply the same shape to two different groups of fixtures, the shape will appear twice on the shape list. You can edit the two shapes separately to give different directions, speeds etc (see later)
- If the selected fixture has subfixtures (cells) then you will be given the option to run the shape on the main fixture, keeping all cells identical, or spread across the subfixtures/cells.
- Each shape is designed to work on a particular attribute. Obviously if the fixtures don't have the attribute, you will not see any effect if you use the shape.
- Each shape has a default size and speed setting (defined in the shape file).



When using a Rainbow colour shape, to get the full range of colours you need to set the CMY or RGB attributes to 50%.

6.1.2 Changing size and speed of a shape

It is easy to change the size and speed of a shape after it has first been created. If the display above the wheels is showing Spread and Offset rather than Size/Speed, press softkey E to select [Adjust Speed, Size and Phase].

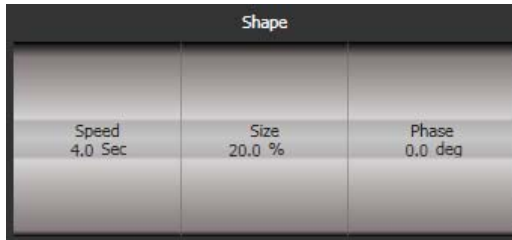

-
- 1> Control the speed of the shape using the left hand wheel.
 - 2> Control the size of the shape using the middle wheel.
 - 3> The size and speed is shown above the wheels on the display.
-

Other things to know about size and speed of shapes:

- If you have more than one shape running, the controls operate on the most recent one. You can edit the parameters of any shape that's running using the Edit Shape function, see section 6.4.1.
- The minimum size is zero. This will "hide" the shape, and the fixture will resume its previous settings. The shape is, however, still active.

6.1.3 Changing the phase of a shape across multiple fixtures

Shapes get more interesting (and look more impressive) when you apply them to multiple fixtures. You can control how a shape is phased across several fixtures. You can also control Spread, which is a different way of selecting the same thing.

The sequence of the shape across the fixtures is controlled by the order in which you selected the fixtures when you created the shape. You can edit the order by selecting [Fixture Order] in the Shape Edit menu.

-
- 1> Press softkey E to select [Adjust Phase, Spread and Offset]
 - 2> Control the phase of the shape using the left hand wheel, or to set in terms of Spread, use the middle wheel.
-

Spread=12 (Phase=30 degrees)

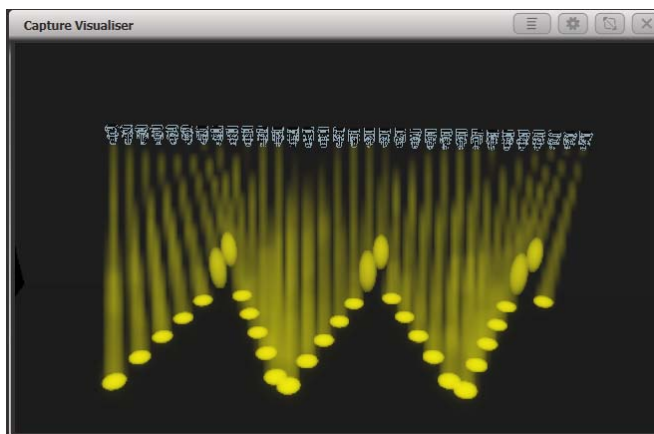

Spread=6 (Phase=60 degrees)

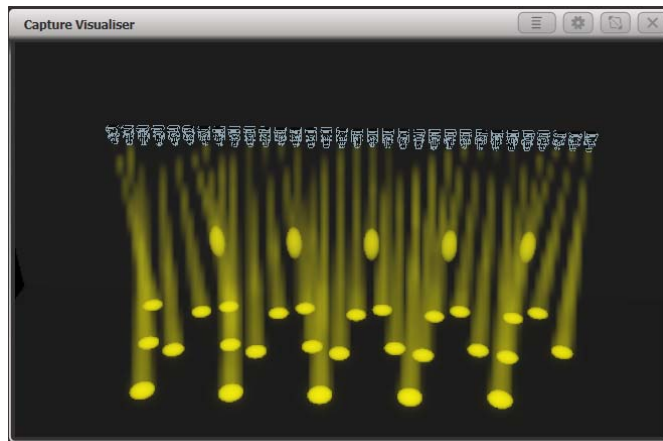

Spread=2 (Phase=180 degrees)

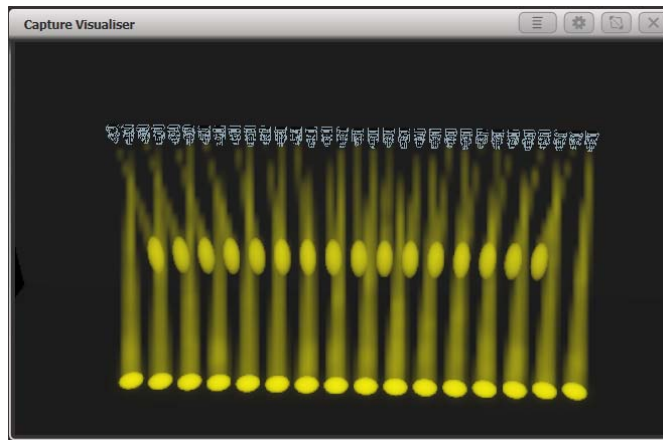

The display above the left hand wheel shows the phase in degrees. For example, 180 degrees repeats every 2 fixtures, 90 degrees repeats every 4 fixtures, 60 degrees repeats every 6 fixtures, and so on.

The Offset function allows you to set the starting phase of the shape, when more than one shape is running. For example, if you were running a Cyan shape and a Magenta shape to create a mix of colours, you would probably want to start them with Cyan at full and Magenta at zero to give the full range of colours. In this case you would set one of the shapes to have a Phase Offset of 180 degrees. Without the phase offset, both shapes would reach full at the same time.

6.1.4 Shape direction

The [Shape Direction] softkey opens a menu allowing you to set a direction for the shape. If you have defined a 2D layout for the group (see *) this allows you to have shapes that visibly move in particular directions.

You can keep the shape direction menu open using the Menu Latch button, to allow you to try different options and see the effects.

6.1.5 Using shapes in cues

When you save a shape into a cue, you can set the playback fader to control the size and/or speed of the shape to give you more options at show time; you can also control the size and speed from Size Masters and Speed Masters. . See 7.6.3 on page 168.

You can use shapes in a cue list and section 9.1.3 on page 185 describes how the shapes will behave as you go from cue to cue.

You can also adjust parameters of the shape at playback time using the Select Shape menu, which is on the [Edit] menu of the Shape Generator menu.

6.2 Key frame shapes

Key frame shapes allow you to create your own shape sequences. You store a series of attribute settings as key frames and the shape fades between them.

6.2.1 Creating a key frame shape

A key frame shape is created a bit like a chase, but the shape is more flexible because you have lots of control over the way the attribute changes between key frames, and you can change the way it spreads across multiple fixtures. It's also (unlike chases) easy to save in cue lists.

You can create the key frames either in Channel Mode by manually setting up a state and pressing [Add Frame], or in Quick Build mode by selecting palettes or cues which will be automatically saved as a frame as you select them. Use the [Record Mode] softkey to select the mode.

In this example we'll create a colour shape, but you can create key frame shapes for any attribute or mixture of attributes. If you create key frames using palettes, the key frames will update if the palette is changed.

- 1> At the main menu press [Shapes and Effects] then [Key Frame Shapes].
- 2> Press [Create] to start a new shape.
- 3> Select fixtures and set the colours for the first key frame.
- 4> Press [Add Frame]. An automatic legend for the first key frame will show above the first playback fader. (Press [Playbacks Display Visible/Hidden] to return the playback faders to normal, if you want to select one in Quick Build mode).



- 5> Continue to set colours and press [Add Frame] until you have created all the steps you want.
- 6> Press [Finish Recording Frames] when you've finished.
- 7> Use the Effect Editor window to change the Spread, Overlap (see below)
- 8> Save the shape to a cue if you want to use it in a show (see section 7 on page 149).

- You can also use the Unfold button to switch the playbacks between normal mode and key frame display mode.
- Setting the [Frame Number] softkey to an existing frame number allows you to [Replace] or [Delete] a frame. Clicking

the frame legend or the select button of the playback will also set the current frame number.

- If the shape is not visible because fixtures are not lit up, the locate dimmer "sun" button at the bottom will light up fixtures used in the shape.

6.2.2 Changing shape parameters in the Effect Editor

Once you have finished creating a key frame shape it will be shown in the Effect Editor window.

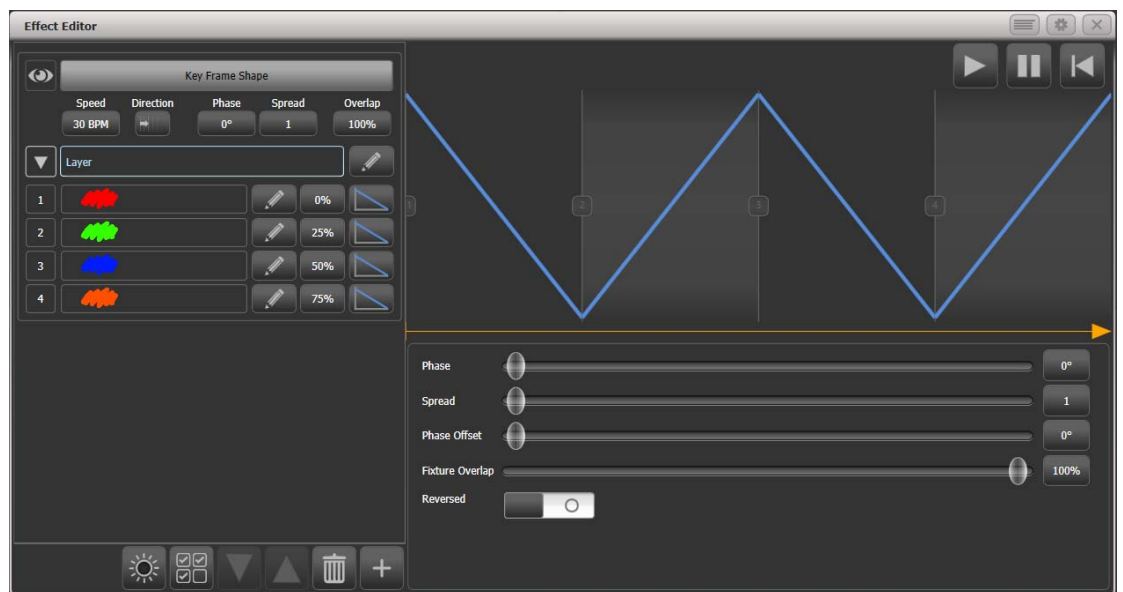

The controls at the top of the left hand pane are the global shape properties which affect the whole shape, controlling speed, direction (using 2D group layout), phase/spread and fixture overlap. The eye icon in the top left corner "collapses" the shape preview in the effect editor window, this allows you to expand only the shape you want to work on if you have created multiple shapes.

The top of the main area shows a graphical version of the fades in the shape, which you can drag around to change the timings. The yellow arrow shows the phase offset for the layer, you can drag this to change the phase.

To start with (or when you click on the Layer name) the sliders in the main area are independent controls for the layer.

You can click on the buttons to the right of the sliders to enter values from the keyboard, and when the button is clicked on the wheels can also be used to adjust the value. A [Reset to default value] softkey is also provided when you click the buttons, or double-clicking the buttons will reset to default value.

By clicking on individual key frames on the left, you can change parameters for each individual frame.

- Timing: use the Start Time slider or drag the step positions in the window.
- Frame A Min / Frame B Max: Sets how close the attribute gets to the programmed value. For example if you've saved a dimmer flash at 100% you could make it only flash to 80%.
- Mid point: sets where the mid point of the fade is

- Width: sets how much of the frame time is taken up by the fade. For example you could fade in 20% of the frame time then hold for the remaining 80%.

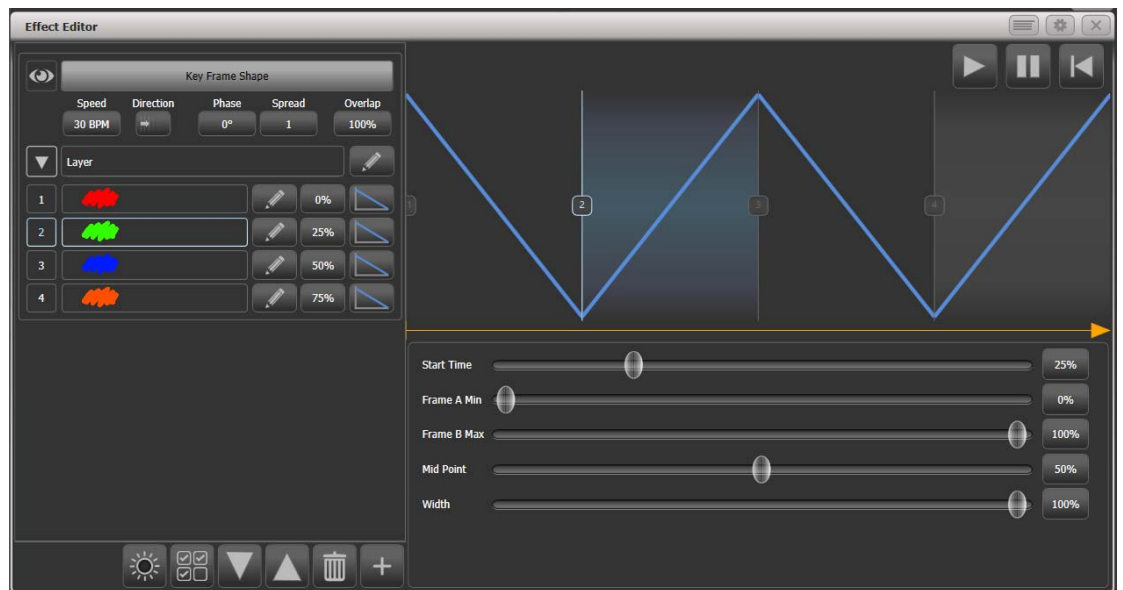

You can change the style of the change between steps by clicking the curve button to the right of each step. The new curve will be shown in the fade graphic in the main window.



You can also edit the sequence of the key frame shape using the Effect Editor window.



- To add more frames to a key frame shape click the pencil button to the right of the layer name.
- To edit a key frame click the pencil button to the right of the frame name.
- To delete a key frame select the frame in the list then click the rubbish bin icon at the bottom
- To change the order of the frames, select a frame then use the up and down arrows at the bottom.
- To change multiple key frames at the same time, click on the multi-select button at the bottom of the window, or you can drag a selection box over the frames.

Key frame shapes can have multiple layers where different effects run simultaneously. To add another layer, click the plus button at the bottom, then select Layers. The new layer will appear in the list on the left.

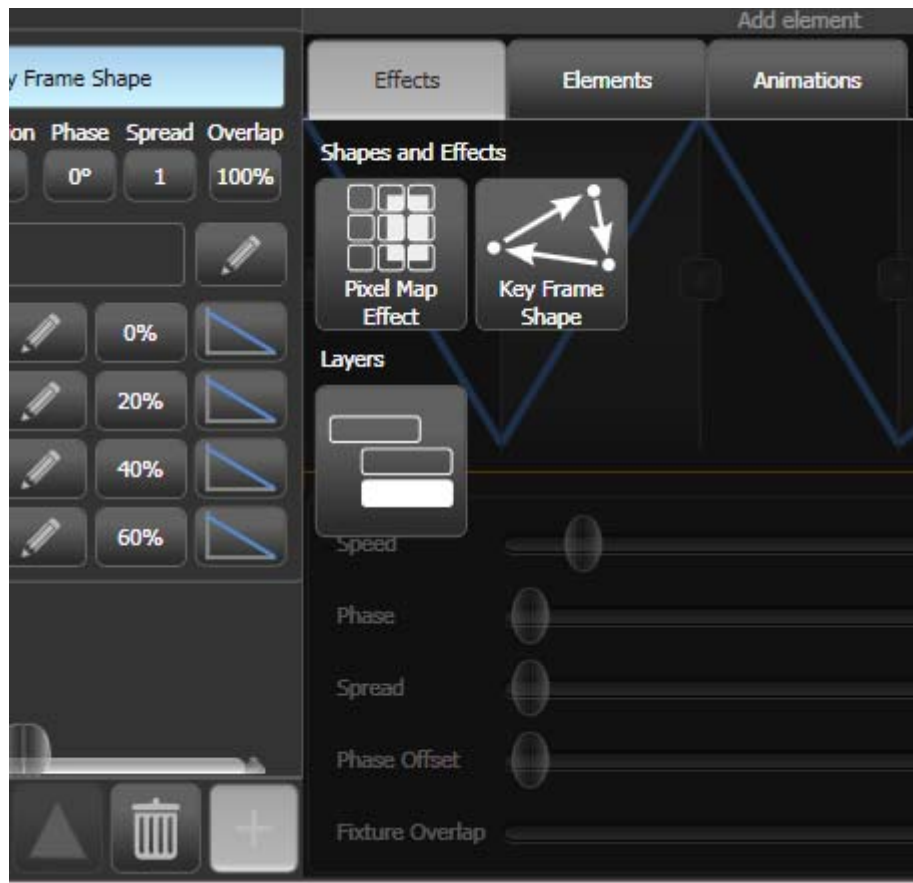

You can also add a completely separate key frame shape or a pixel map effect. Pixel map effects will be shown at the top of the shape list on the left, you can use the eye icon to hide the pixel map effect when you want to work on the key frame shapes.

6.2.3 Saving a key frame shape to a cue

By default when a key frame shape is saved to a cue, the playback fader will fade the shape. If the playback is set to have Speed on Fader, the fader will master the speed of all layers in the shape.

When a key frame shape is running in a playback it can behave as Overlay or LTP. A global value for Shape Behaviour is in the User Settings, but you can also set the mode in Playback Options for each playback.

- In Overlay mode (default) the shape will have control of the programmed attributes regardless of whatever else you do. For example if a key frame shape is controlling fixture colour, firing another playback, recalling palettes or changing colour using the wheels will have no visible effect. Once the shape is stopped, the changes you made will become visible. This means that if you want to you can preset what will happen when you stop the shape.
- In LTP mode, changes of the same or higher priority will override the shape output. For example if your key frame shape is set to normal priority, firing a playback with normal priority will block the shape output. Killing the playback will restore the shape output. Quick Palettes and manual changes (the programmer) have High priority. Setting the shape priority to

“Very High” would prevent the programmer taking over (see section 7.6.1 on page 167 for how to set priority).

For details of how Key Frame Shapes behave in Cue Lists, see 9.1.3 on page 185.

6.3 Pixel mapper

6.3.1 Creating Pixel Mapper effects

The Pixel Mapper works on a group of fixtures, which you have set up using the Fixture Layout function. This tells the console where the fixtures are physically located on the stage. The console then maps the fixtures as pixels and uses them to output a 2D effect. See section 4.3.2 on page 93 for details of how to layout the fixtures.



At the end of this section (Section 6.6 on page 127) there are a number of step-by-step examples of creating effects with the pixel mapper.

You set up the Pixel Mapper as follows.

- 1> *Select the group of fixtures.*
- 2> *From the top level menu select [Shapes and Effects] then [Pixel Mapper]*
- 3> *Select [Create effect]. The Pixel Mapper Editor will open with a blank background. You can overlay your fixture layout on the window, to help you see where your fixtures are, by clicking on the [Fixture Overlay 50/50] context menu button.*

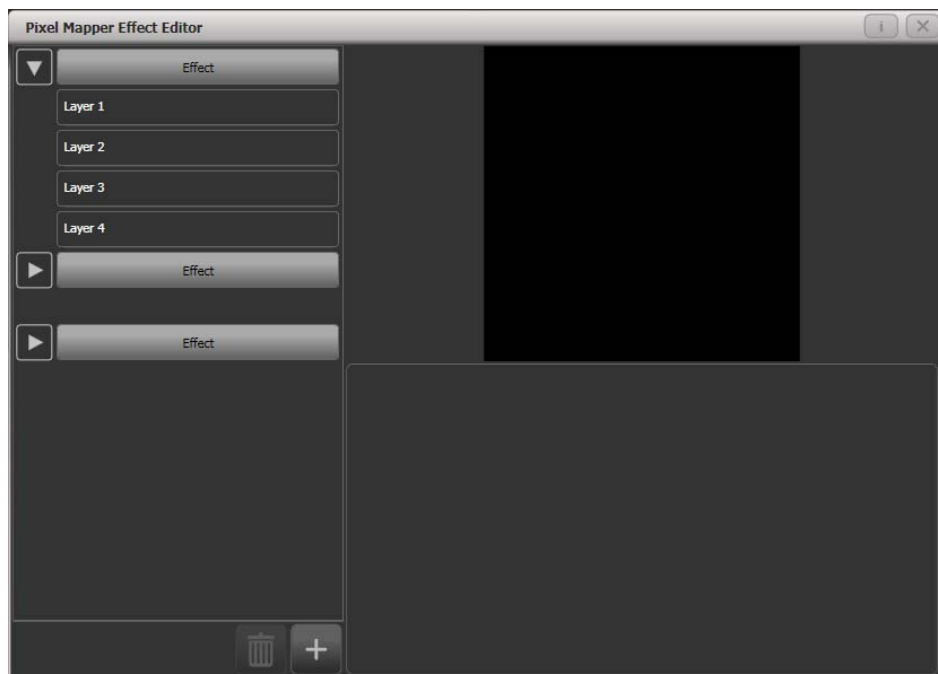

Click on the + button at the bottom to add an effect, and choose a graphic element. The graphic buttons as shown below provide the following effects:

- Square
- Circle

- Triangle
- Star
- Fan
- Spiral
- Text
- Scribble (you draw an image on the touch screen)
- Image/bitmap (loaded from disk)

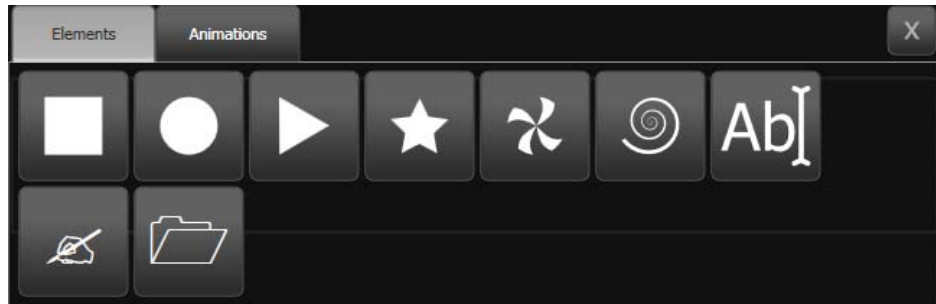

Then click on the + button again and choose an animation (how your graphic element will move). The animated effect will show in the black window.

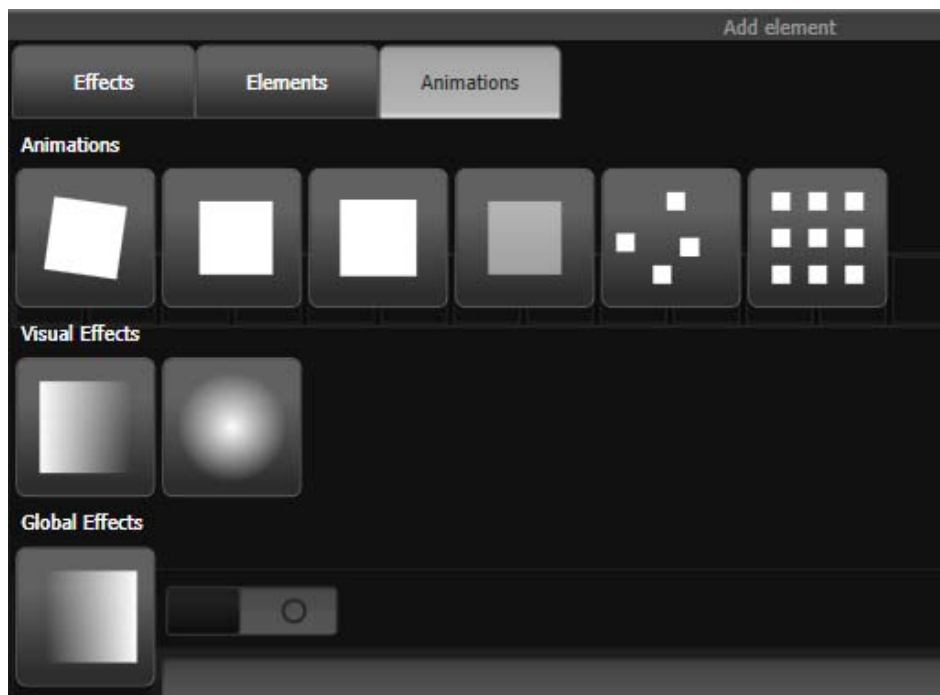

Available animations are:

- Rotate
- Slide
- Zoom
- Opacity/Fade
- Random
- Grid Fit (elements will accurately align with the pixel grid)
- Linear gradient
- Radial gradient
- Motion blur (adds a trail to objects)

Edit the parameters of the effect by clicking the effect name on the left hand side. Sliders are provided to configure the effect, the sliders may vary depending on the particular effect.

- For Grid Fit you need to specify the number of rows and columns in the grid.
- For the gradient animations you set the start and end opacity and the offset between them; you also set the Spread which can be Pad (single gradient), Reflect (repeats the gradient in and out) or Repeat (snaps back to start then repeats the gradient fade)

Edit the colour of the effect by clicking on the Layer on the left hand side.

Edit the way the animation moves by clicking the animation name on the left.

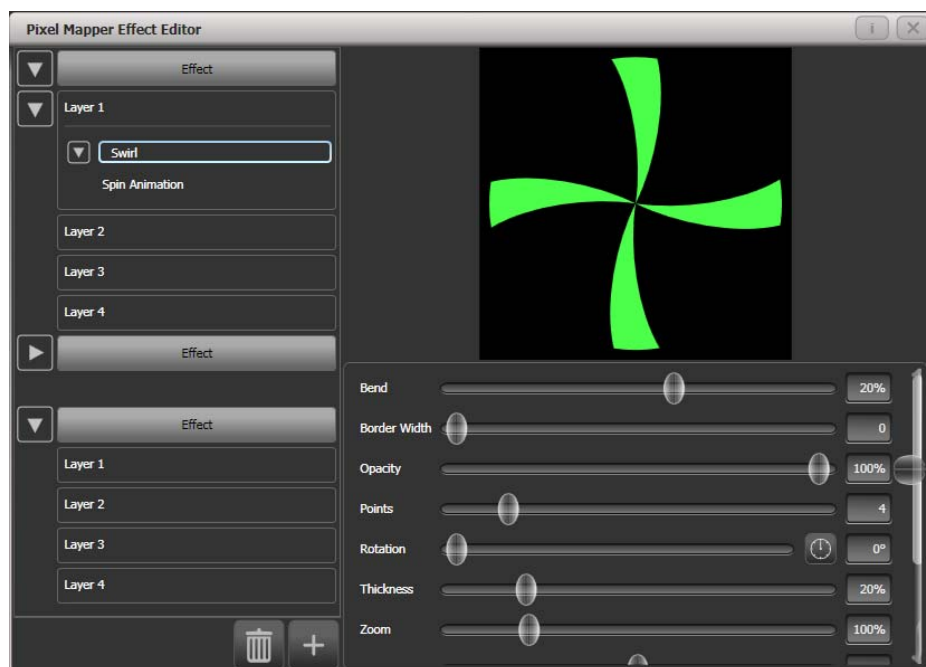

To see how the effect will look on the fixtures, open the Pixel Mapper preview window by pressing Window Open, [Open Workspace Window], [Pixel Mapper Preview]. A real life view of each effect running is shown in a button at the bottom of the screen, you can select each of these by pressing the button.

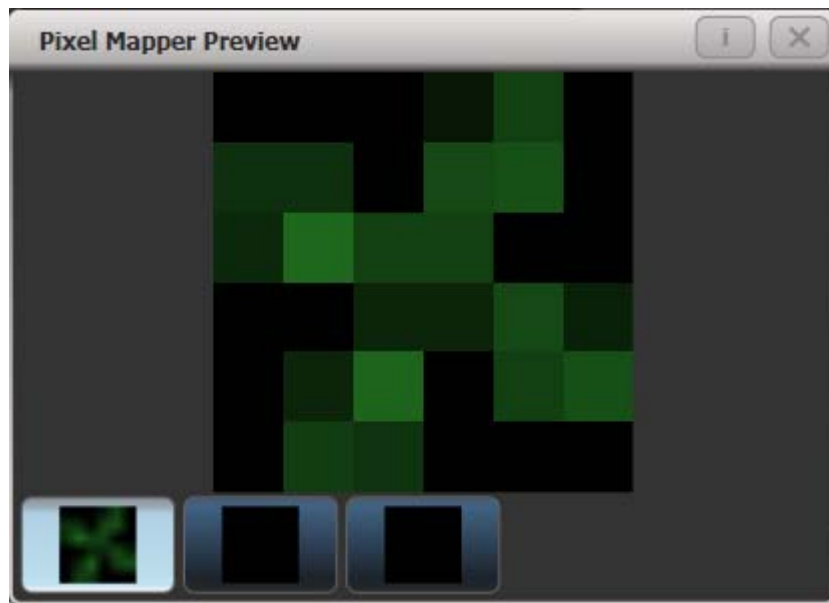

If you wish you can overlay further layers on the effect. Once you have an effect you like, you can save it to a playback.



When adjusting the parameter sliders, as well as using click/drag on the screen you can also use the wheels or type in a numerical value. To assign a slider to the wheels or for numerical input, click the value box to the right of the control. Double click the value to reset it to its default, or use the +/- softkey to change the sign of the value.

- You can reorder the Pixel Mapper layers by selecting the layer to move and clicking on the up/down arrow buttons.
- You can copy or move layers, elements and animations by pressing Copy or Move, then select an element, then select a destination to copy or move it to.
- The Block Effect switch allows you to create a pixel map effect which will block out any pixel maps running on the selected fixtures (according to the priority setting). This lets you create a cue which will temporarily stop a pixel map effect (similar to Block Shapes).

6.3.2 Pixel mapper Layer Masters

You can assign each of the four layers to a master. The master allows you to adjust the layer controls in real time. When the master is assigned to a fader handle using the [Assign Masters] [Pixel Mapper] controls, the fader will control opacity of the layer.

This means you can create cues and palettes which can manipulate the layer settings of effects which are running in other cues.

To enable the layer master, turn on the Use Master switch in the effect editor window.

- Layer masters may require an updated personality file.

6.4 Editing shapes and effects

6.4.1 Editing shapes and effects in cues

Shapes and pixel mapper effects stored in cues can be edited from the Cue View window.

Playback View - Cue 'Fast Dim Shape'										
	Delay In	Fade In	Fade Out	Fixture Overlap	MiD Delay	MiD Fade	Curve	View Cue	View Shape	View Pixel Effect
0	0	0	Disabled	100%	0	0	Linear	View	Dimmer Pulse 1:1	

To view and/or edit the parameters of the shape or effect, click on the View Shape or View Pixel Effect button. If more than one shape or effect is stored, the button will show [...]. A Shape View window or Pixel Mapper Effect View window will open, listing the shapes or effects in the cue. You can then edit parameters of the shape or effect by clicking on the parameter and editing on the softkeys.

In the Shape or Effect View window you can click on View Fixtures to open a window showing a list of the fixtures on which the shape or effect is programmed.

6.4.2 Selecting a running shape to edit

You can only edit shapes which are in the programmer; if you fire a cue with a shape in it, the shape will not show up in the list of editable shapes. To get the shape into the programmer you need to use the Include function (see section 7.3.4 on page 160).

If more than one shape is running in the programmer, you can select which one is connected to the control wheels using Shape option [Edit].

-
- 1> If you are not in the Shape menu, press [Shapes and Effects] then [Shape Generator] at the top menu.
 - 2> Press [Edit].
 - 3> Press [Select shape]
 - 4> By the softkeys is a list of the currently running shapes.
 - 5> Press a softkey to make the shape active. The active shape is highlighted.
 - 6> Press Enter to get back to the Shape Generator menu.
-

- If you applied the same shape several times to different fixtures, you can change each copy of the shape independently.

6.4.3 Resynchronise shapes

The [Restart Shapes] option in the Shape Edit menu allows you to restart all running shapes, this is useful if you have multiple shapes running and you need to see how they will interact.

6.4.4 Changing fixture order in a shape

The way a shape spreads across a number of fixtures is set by the order in which you selected them when you create the shape. You can change this order using the [Fixture Order] function in the [Edit] menu. The current fixture order is shown in in the fixture touch keys . See section 7.5.2 for details on how to set fixture order.

6.4.5 Removing or adding fixtures

You can add or remove individual fixtures from a shape using the [Add/Remove Fixtures] option in the [Edit] menu, or use the context menu button in the Shapes Fixture view window. All fixtures currently included in the shape will be selected. You can select or deselect fixtures to add or remove them from the shape.

6.4.6 Reversing a shape

You can reverse the direction of a shape by pressing [Reverse Selected Fixtures] from the shape menu. The shape will be reversed only on fixtures which are selected, allowing you to run the shape forward on some fixtures and backwards on others.

6.4.7 Deleting shapes

You can delete a running shape by pressing [Delete] from the shape menu, then pressing the softkey for the shape you want to delete.

6.5 Advanced options

6.5.1 Fading shape size and speed

When a shape is stored in a cue, you can set how the shape fades in using the Edit Times and the Playback Option settings.

To set the shape size and/or speed from the fader position, press [Playback Options] from the main menu then press the select button of the playback.

Using the [Fader] [Shape Size] and [Shape Speed] buttons you can set the shape size and speed to be fixed (how you programmed them) or to grow larger/speed up as the fader is pushed up. You can also allocate a Speed or Size Master to control the speed or size, see section 7.2.5 on page 154.



When you use dimmer shapes, set the playback to [Shape Size on Fader] so that the shape fades in as you push up the fader. Otherwise the dimmer shape will snap in at full brightness when the fader passes the trigger point. From Titan v9 this is the default setting.

To set a fixed fade in time for the shape size, press [Edit Times] from the top menu, then the playback select button, then set the Delay/Fade times you want.

The Fade Mode allows you to set mode 0 (fade in), mode 1 (fade in and out) or mode 3 (crossfade). Mode 2 links fade times to the fader position, however we recommend you use the Playback Options listed above to do this for shapes, and do not use Mode 2.

If a new cue is fired which controls the same attributes (for example, a second shape controlling the same fixtures as a currently running shape), the new shape will crossfade from the running shape.

6.6 Pixel Mapper examples

6.6.1 Randomising effects

This example shows you how to use the pixel mapper to create an effect where random dimmer cells turn on. This effect will overlay any existing intensities.

- 1> *The fixtures you want to use need to be recorded into a group, do this first if they are not already.*
- 2> *Adjust the layout of the fixtures in the group using [Shapes And Effects]/[Pixel Mapper]/[Edit Group Layout]/(select group).*
- 3> *Start creating an effect by selecting the group then [Shapes And Effects]/[Pixel Mapper]/[Create Effect].*
- 4> *In the Pixel Mapper Effect Editor window toggle the context menu option 'Fixture Overlay' until it reads 'Fixture Overlay 50/50'. (This will allow you to see the relationship of your fixtures to the effect as you create it.)*

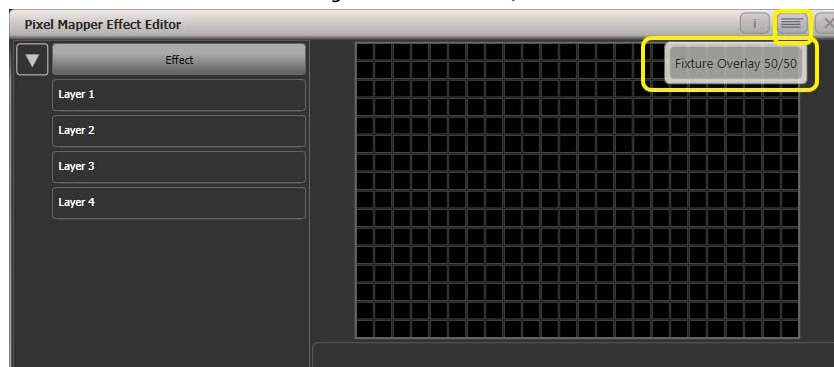

- 5> *Select [Effect] and drag 'Background Opacity' slider to 0%. (This will allow the whole effect to overlay any related intensities.)*

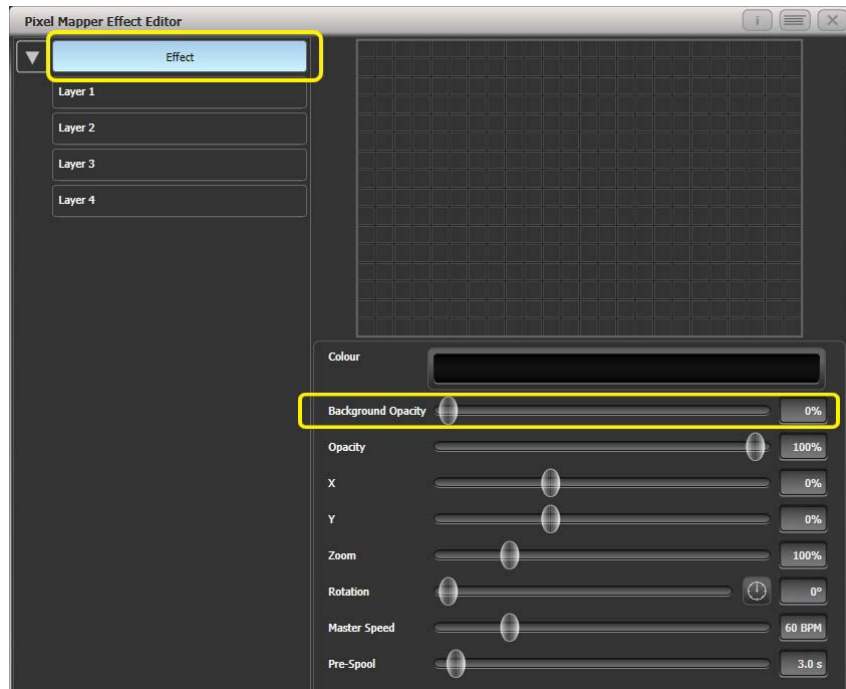

6> Select [Layer 1], click [+] at the bottom of the screen and then choose Circle from the elements that appear.

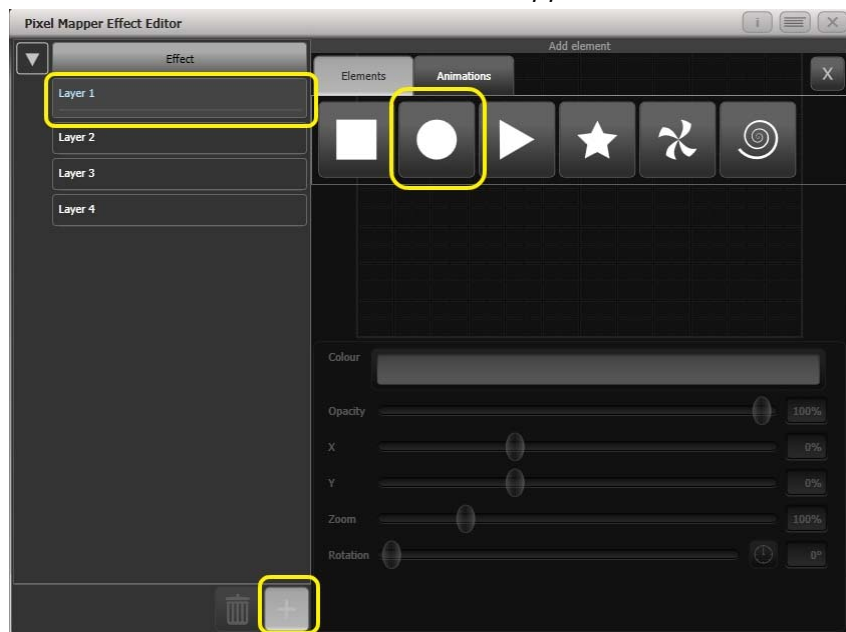

7> Drag the 'Zoom' slider until the circle covers approximately one cell. You can also use the 'Width' and 'Height' sliders to turn the circle into an oval if that helps. Then drag the 'X' and 'Y' sliders to position the circle roughly in the centre of your fixtures if it is not already.

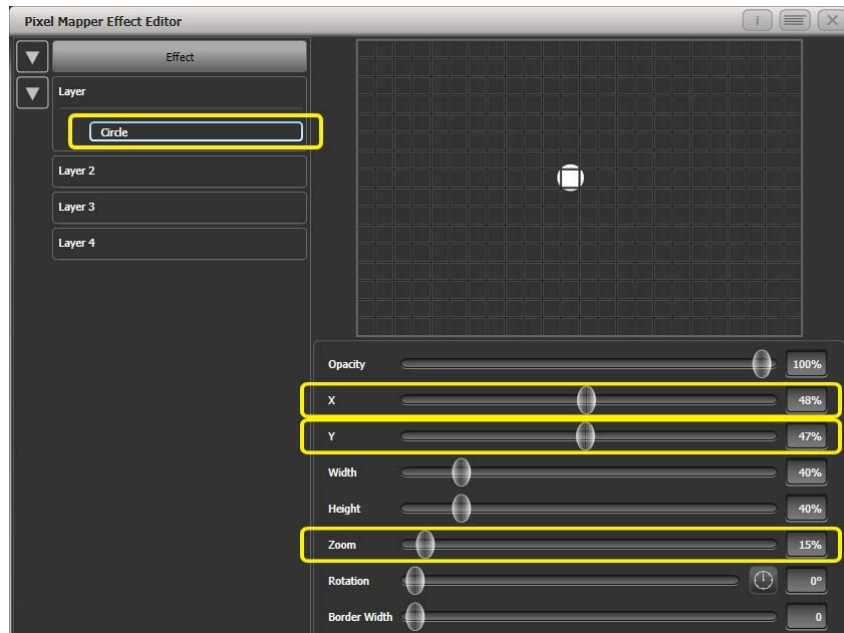

- 8> Select [+] again and choose *Displacement* from the animations that appear (this is represented as a few static blocks). (Note that nothing changes yet.)

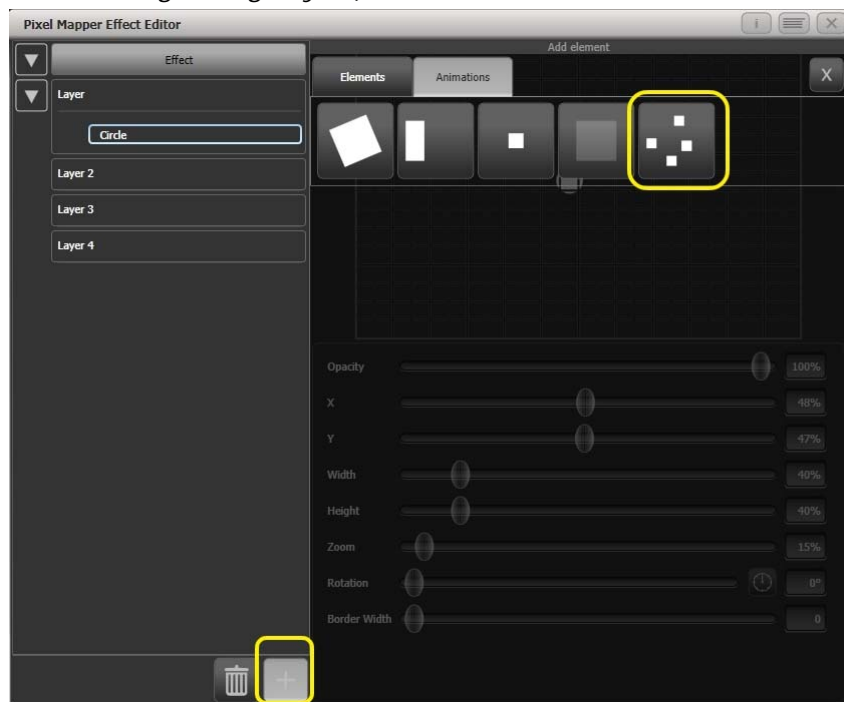

- 9> Select [+] and this time choose *Opacity* animation (represented as a block fading in).

The displacement acts on the opacity animation causing it to appear at random locations each time it is drawn.

Drag the 'In Time' and 'Out Time' sliders to 0%. (This will cause the effect to snap on/off instead of fade.)

Increase the 'Speed' and 'Spawn Rate' settings to make the effect run quicker and with more circles respectively. (High spawn rates are particularly useful for small randomised elements like this.)

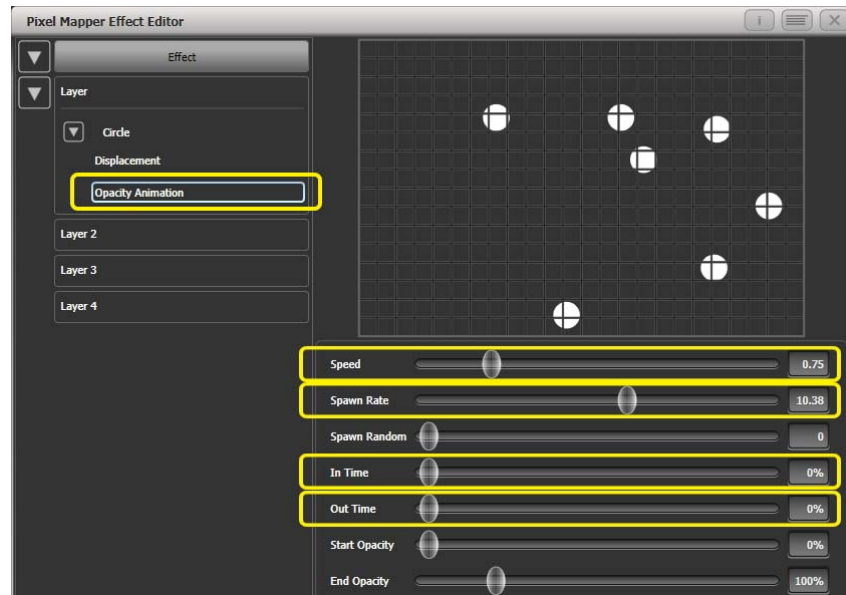

10> Record to a playback.

6.6.2 Overlaying effects

This example shows you how to create a diagonal white wipe with a rotating red fan on top.

- 1> Select a group containing a fixture layout as described in previous example.
- 2> Start creating an effect by selecting the group then [Shapes And Effects]/[Pixel Mapper]/[Create Effect]
- 3> Select [Layer 1], click [+] at the bottom of the screen and then choose Block from the elements that appear.
 Drag the 'Rotation' slider to the right to angle the element at approximately 25 degrees.
 Drag the 'Width' slider to the left to make a thinner block.
 Drag the 'Height' slider to the right until the block fills the height of the entire window.
 Drag the 'X' slider to the right until the block is just off the screen.

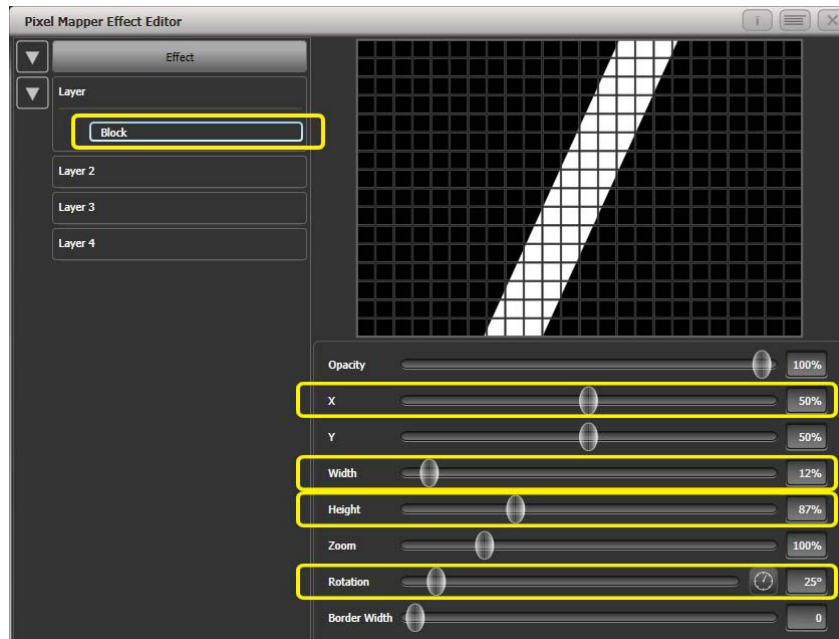

- 4> Click [+] again and choose Linear Movement animation (represented as a block moving left to right).

On the right side of the 'Direction' slider there is a compass button. Click on this four times until the direction reads 270 degrees. (By default the animation is set to 90 degrees or left to right. Because we placed the block on the far right of the screen we want it to move the other way. The compass gives shortcuts to the more common directions in 45 degree increments.)

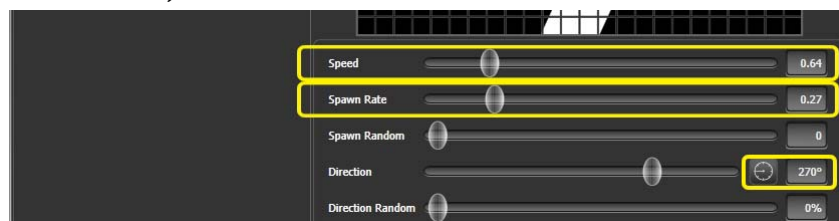

Reduce 'Spawn Rate' until only one stripe is on screen the same time. For this type of effect the value will usually need to be quite low - approximately 0.2.

You might want to reduce 'Speed' slightly at this point. (Note that a higher speed was initially useful for getting the correct spawn rate above.)

- 5> Click on [Layer 2], select [+] and select the Swirl element (represented by a 'fan' shape with four arms).
 Increase 'Zoom' until it is as large as will fit in the screen.
 Set 'Bend' to 0% for nice straight fan blade edges.
 Set 'Points' to 3 (minimum) for a three bladed fan.
 Set 'Thickness' to 50% for evenly sized segments.
 Increase 'Border Width' to a low value so that we just have an outline.

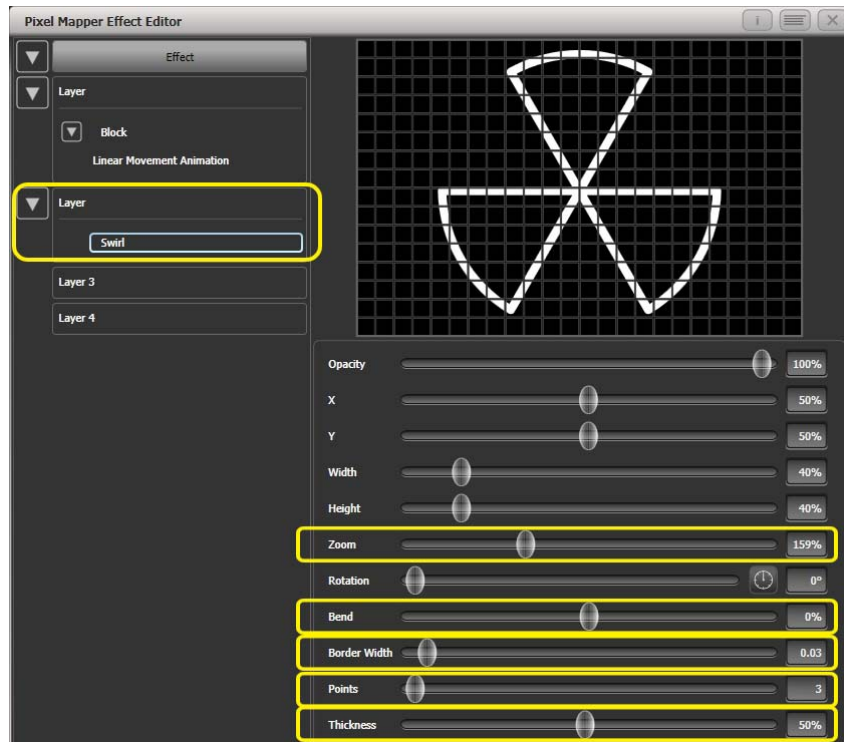

- 6> Click on [+] and add a spin animation.
Reduce the speed until it just causes a light breeze.
- 7> Click in the top of this layer to get the layer controls.
Click on the colour bar to open the colour picker.
Click and drag to the top left of the picker window to get a strong red.

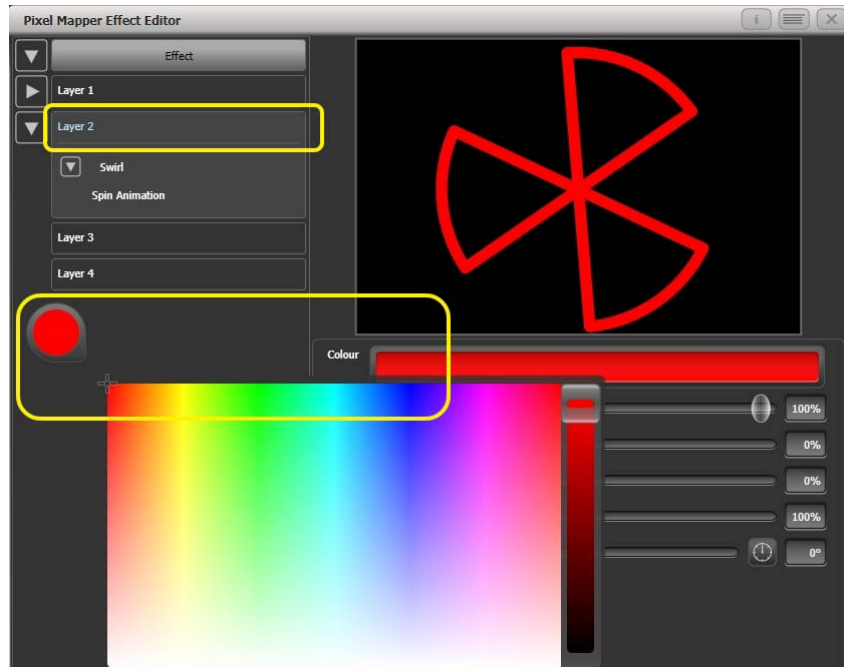

- 8> Click on [Effect] at the top left to access the global controls.
Drag 'Pre Spool' to the left until it reads 0s. (This is to ensure the wipe begins off screen where we placed it when it is fired.)
- 9> Record the cue.

- Note how the red fan sits on top of the white bar when they interact. This is because the white is on a lower layer. A higher layer number has priority over a lower number.

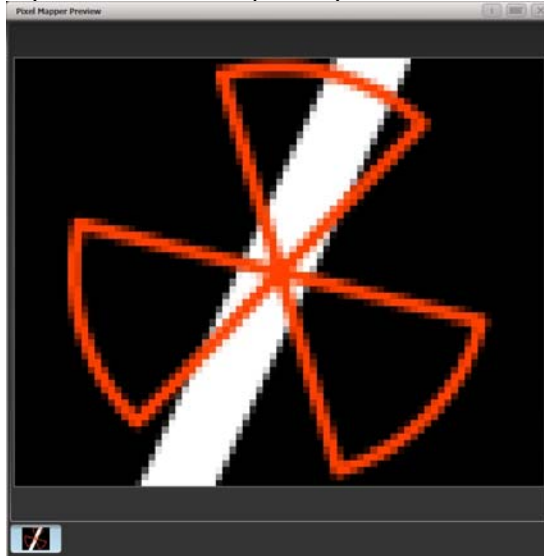

6.6.3 Creative use of fixture layouts

Because each fixture group can contain a different layout it is possible to create more than one arrangement of the same fixtures for pixel mapping.

By arranging fixtures in certain layouts you can easily achieve complex effects.

Example 1: Odd/Even

-
- 1> *Select your fixtures.*
 - 2> *Open the Selection Pattern menu by pressing the 'All' key.*
 - 3> *Choose [Odd] from the softkey options. (This will select all the odd numbered fixtures according to fixture order.)*
 - 4> *Record a group.*
 - 5> *Press '+1' (or 'Next') key. (This will select all the even numbered fixtures.)*
 - 6> *Merge this into the first group.*
 - 7> *Open the Layout Editor. ([Shapes And Effects]/[Pixel Mapper]/[Edit Group Layout]/(select group).)*
-

By doing the above you should be able to see how we have quickly created a layout where the all the odd fixtures are arranged together on the left followed by all the even fixtures on the right.

This arrangement could be used as it is. A block element animated to run horizontally left to right will run across all your odd fixtures followed by all the even fixtures.

An alternative goal might be a vertical 'cascading' effect:

- 1> Click on the vertical resize tool and drag down until the grid is at least twice the original height.

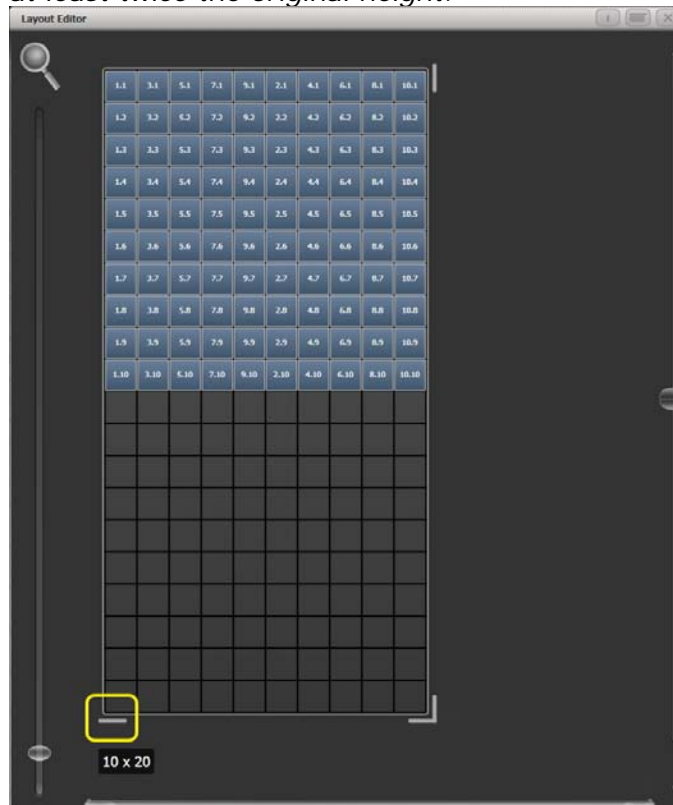

- 2> Drag a marquee select across the even fixtures.

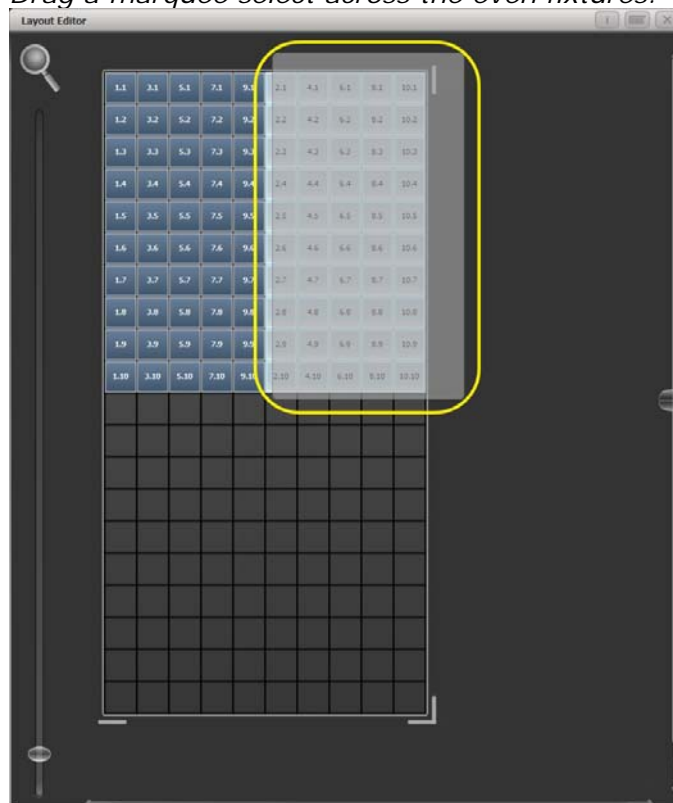

- 3> Drag the selected fixtures so they sit directly under the odd fixtures.

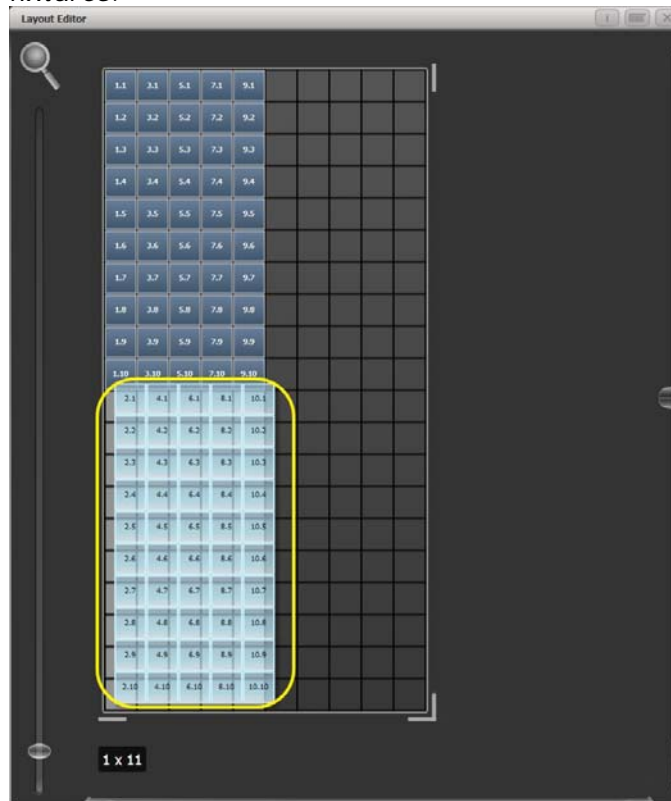

- 4> Select 'Crop Grid' from the Layout Editor context menu. (This will get rid of the unused pixels.)

Now a block element animated to run vertically from top to bottom will run down the odd fixtures followed by the even fixtures.

Example 2 - Pseudo random

- 1> Select your fixtures and create a group.
 2> Open the Layout Editor.
 3> Click on the vertical resize tool and drag down until the grid is at least twice the original height.

Note that to help with creation and manipulation of larger grids you can use the zoom control on the left-side of the window. Clicking on the magnifying glass gives a quick shortcut to zoom in/out.

- 4> Select the group again. (This will quickly select everything in the layout.)
 5> Press '+1' key. (This will select the first fixture.)
 6> Use the wheel to adjust 'Position Y'.

Repeat steps 4 and 5 until all the fixtures are at different heights in relation to one another.

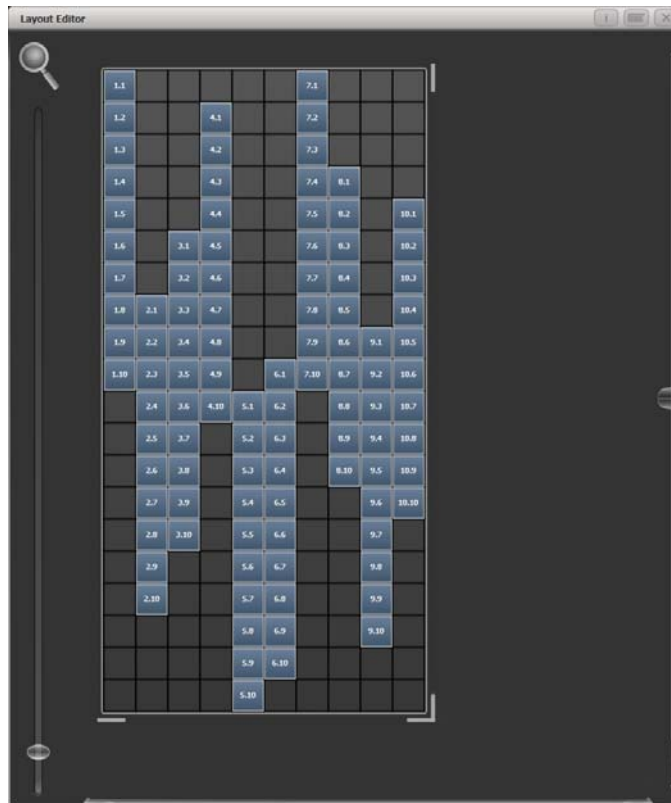

If you create an effect using this group it will appear to be random. Adjustments can be made to the layout at any time to fine-tune the end result.

Example 3 - Angles (or 'when straight just isn't good enough..'):

Sometimes we like to hang fixtures at artistic angles to look pretty. By default the software assumes you have hung them vertically but fear not - Titan has a solution:

-
- 1> *Select your fixtures and create a group.*
 - 2> *Open the Layout Editor.*
 - 3> *Select the fixture(s) that you want to angle and use the appropriate wheel to control. (If wheels are not assigned to control the cell layout you can toggle this on/off using the context menu item 'Wheel Control'. Also, on the Pearl Expert you may need to select 'Adjust Angle' and to return wheels to controlling position select 'Adjust X,Y'.)*
-

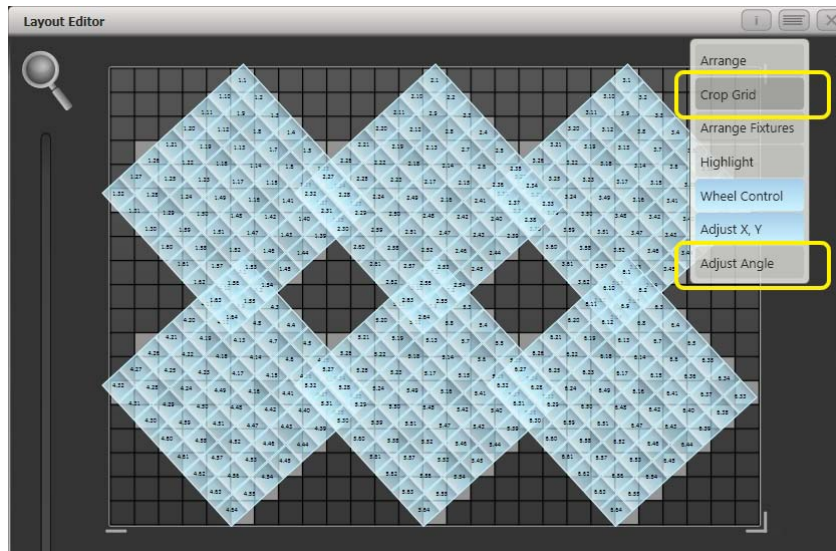

Note that underneath the visual representation of the fixtures the actual cells used are shown in light grey.

If any of your fixtures have been naughty and ended up beyond the bounds of the grid after rotating you can use context menu item 'Crop Grid' to make them behave.

6.6.4 Other Layout Editor tools

The Layout Editor's context menu has some useful tools for laying out fixtures quickly.

Context menu - 'Arrange Fixtures'

This is a very useful tool to quickly layout fixtures in a grid. For example you might have 20x Colourblocks across four towers, each with five blocks.

- 1> *Select the fixtures and create a group.*
- 2> *Edit the layout of this group.*
- 3> *Select 'Arrange Fixtures' from the context menu.*
- 4> *Select the [Height] softkey and type '5'. (Width will automatically be calculated.)*
- 5> *Toggle [Crop Grid to fixtures] so that it is highlighted. (This will make the grid adjust to fit.)*
- 6> *Toggle [Arrange in..] to 'Columns' or 'Rows'. 'Rows' will arrange fixtures left to right and 'Columns' will arrange top to bottom.*
- 7> *The [Shape] option allows you to arrange in Rectangle, Oval or Triangle.*
- 8> *Select [OK] to complete.*

Context menu - 'Highlight'

When enabled this will highlight selected fixtures live on stage. This can be useful to see which fixture you are positioning in the layout.

Context menu - 'Arrange/Select Only'

When set to 'Select Only' fixtures are locked in position on the grid and cannot be dragged around. This provides an alternative way of selecting fixtures to edit while preventing accidental movement.

If you find you suddenly cannot move anything around this is probably the reason!

Note that X,Y and Angle wheel control is still available.

Context menu – 'Wheels Move Full Pixel/Sub Pixel'

Allows you to position fixtures across pixel boundaries when using the wheels. The **Snap** option centres the fixture on the nearest cell.

Context menu – 'Wheels Rotate Individual Fixtures/Selection'

Sets whether individual fixtures rotate, or whether the whole selection rotates.

6.6.5 Playback Order and Priorities

Suppose you wished to create a white pulsating oval on one playback and a blue spiral on a second playback. Normally these effects would layer differently depending on the order you fire the playbacks, but you can use playback priorities to make them always layer the same way

To create first effect:

- 1> *Select a group containing a fixture layout as described in previous example and go to [Create Effect].*
- 2> *Select [Effect] to access the global effect controls and change 'Background Opacity' to zero. (This will allow it to overlay the other playback.)*
- 3> *Double-Click [Layer 1] (or press [+]) and choose Circle from the elements that appear. (Double-click is a shortcut to elements and animations.)*

Reduce height to make a rugby ball (or American football if you insist).

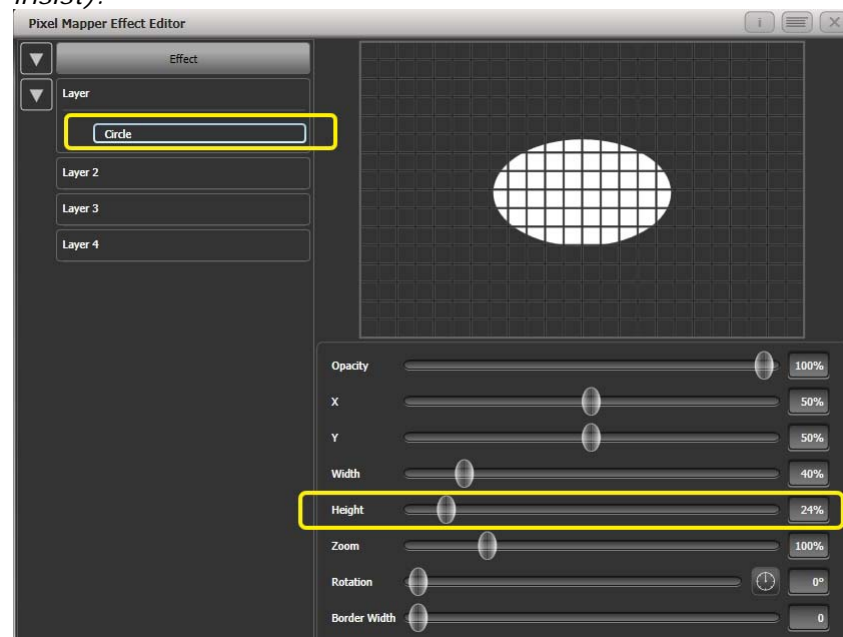

- 4> Double-click on [Circle] (or press [+]) and select the Zoom animation.
 Drag 'In Time' to zero and 'Out Time' to 100%. (This will make the effect start large and finish small. Alternatively the same effect can be created by making 'Start Zoom' larger than 'End Zoom'.)
 Increase 'End Zoom' until the element begins by filling the whole window.
- 5> Double-click on [Zoom Animation] (or press [+]) and select the Opacity animation.
 Reduce 'Spawn Rate' to zero. (This will ensure the opacity only works on the zoom animation.)
 Drag 'In Time' to zero and 'Out Time' to 100. (This will make the effect snap on and fade out as it reduces in size. As with zoom you can achieve much the same thing by inverting the opacity controls instead. Using opacity values greater than 100% will create a delay before fade.)

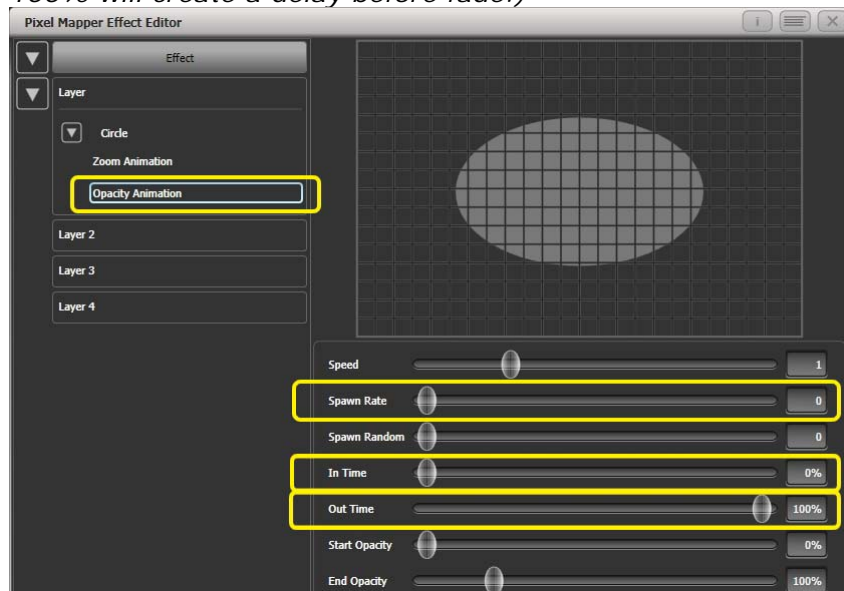

- 6> Click on [Effect] again and reduce 'Master Speed' to your preference. (Adjusting the global speed control ensures the zoom and opacity animations are synchronised instead of

having to manually match the individual values.)

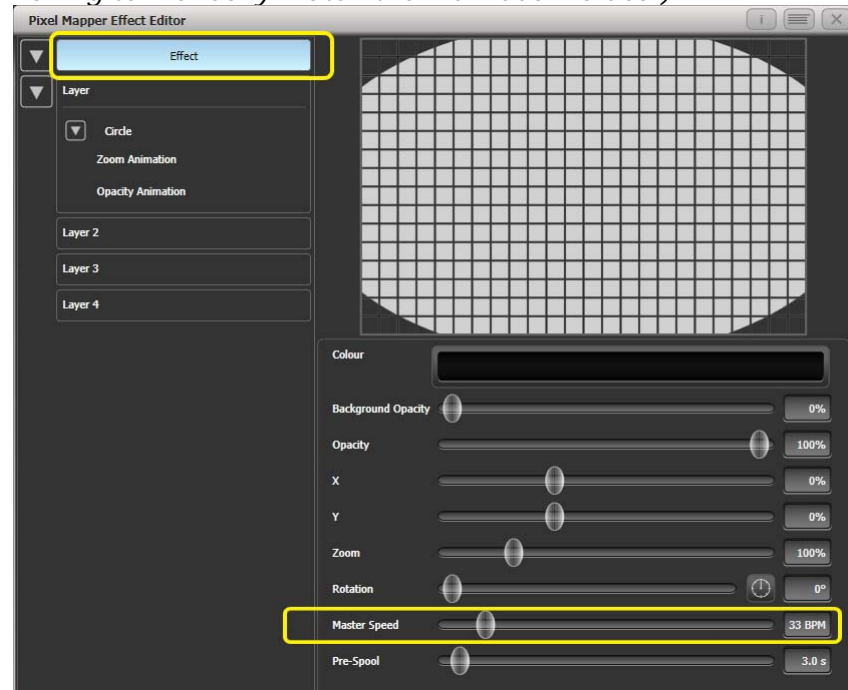

7> *Record the cue.*

Next we will create the second effect:

- 1> *Select the same group as used for the first effect and [Create Effect]*
- 2> *Select [Effect] and change 'Background Opacity' to zero.*
- 3> *Select [Layer 1] and this time add a Spiral element.
Increase 'Zoom' so that it's nice and big.
Drag 'Thinning' until it is at 0%. (This will make the lines of the spiral stay the same width. A negative value means the spiral gets thinner towards the outside; a positive value means it gets thinner towards the inside.)
Reduce 'Turns' so we can make a more bold effect. Approx. 3 should work.
Increase 'Thickness' to 50% for chunky lines.*

Increase 'Exponent' to around 25%. (This causes the spiral to 'expand' at a faster rate.)

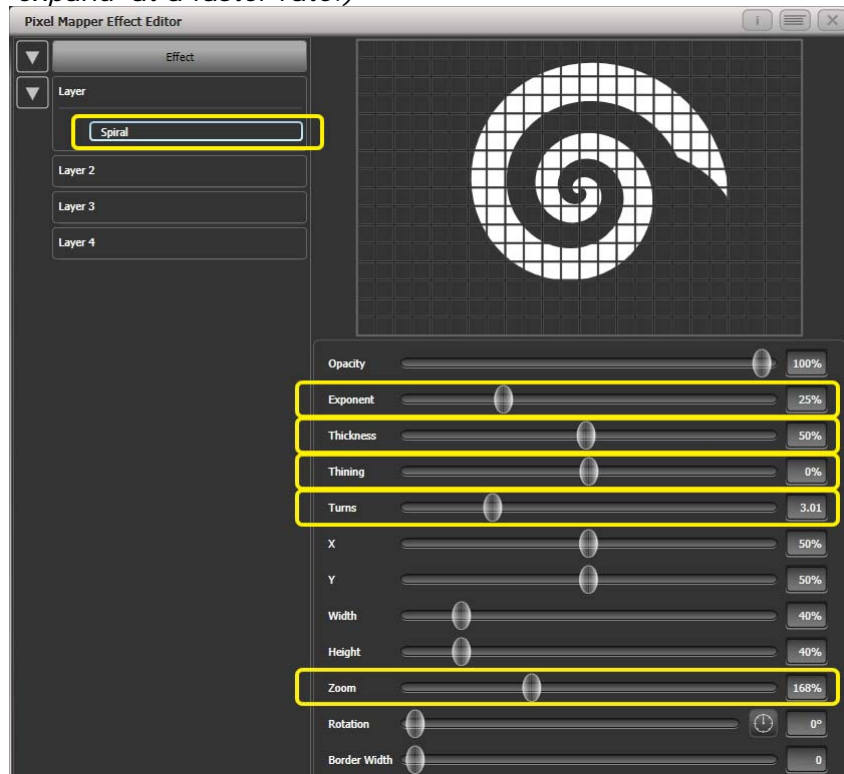

- 4> Add a Spin animation for genuine psychedelic effect. Adjust speed until you are unable to look away from the screen.
- 5> Select the Layer to show the layer controls and change the colour to blue using the colour picker.

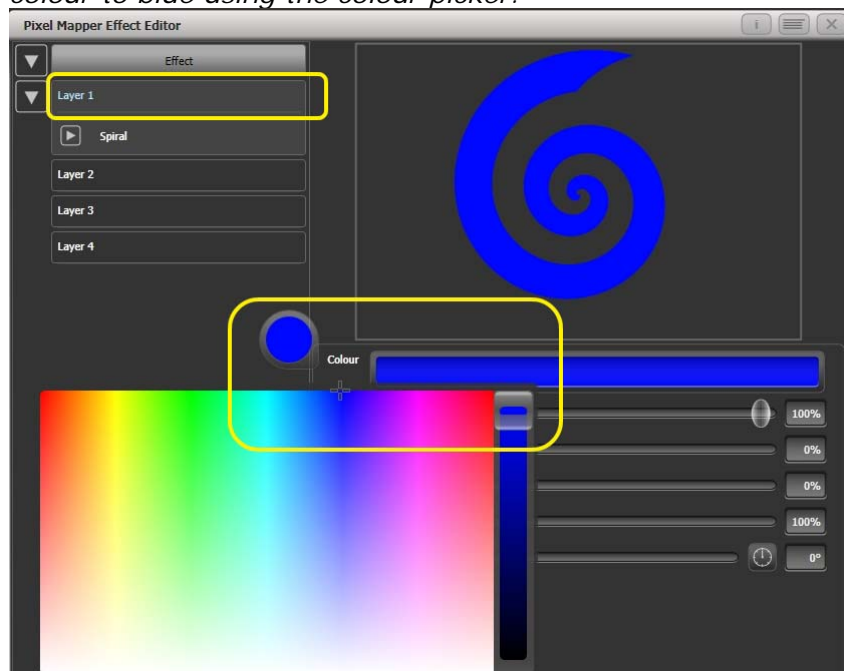

- 6> Record the cue.

Now let's look at how they interact on the playbacks:

- Fire the blue spiral effect.

- Fire the white pulse.

Notice how the white takes priority over the spiral. The blue spiral only appears as the white oval fades out and gets smaller.

- Kill both effects.
- Fire the white pulse.
- Fire the blue spiral.

This time the blue spiral sits on top of the white pulse. That is because the playbacks are following a 'latest takes precedence' rule (LTP).

To guarantee the blue spiral always sits on top you can set it to be a higher priority:

- Kill both effects.
- [Playback Options]/Select the blue spiral playback.
- Press [Previous] or [Next] until you can see [Priority Normal] on the softkeys. Press this to toggle it to [Priority High].
- Now fire the blue spiral followed by the white pulse.

Even though you fired them in the same order as the first example the blue spiral now sits on top of the white pulse because it has a higher priority.

6.6.6 Displacement and Layer Properties

In this example we create random flashing bars, and use layer controls to make global adjustments to the whole effect.

-
- 1> *Create a group and adjust the fixture layout as described in previous examples.*
 - 2> *Select this group and begin creating an effect.*
 - 3> *Select [Layer 1] and add a 'Block' element.*
 - 4> *Adjust the width and height sliders until we have a thin strip that covers at least one cell vertically and the whole grid*

horizontally.

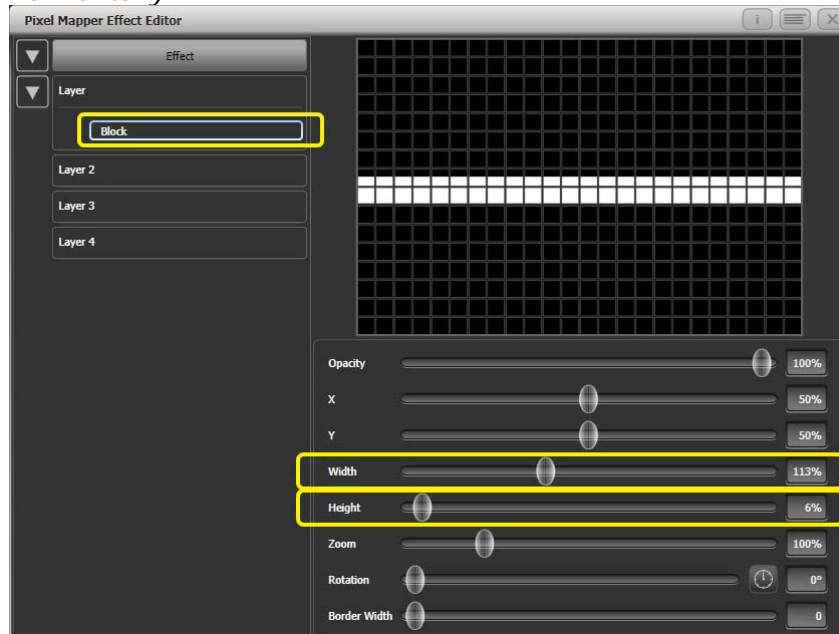

- 5> Reduce Y until the bar disappears off the top of the grid. (This is in preparation for adding a displacement animation.)
- 6> Add a Displacement animation. By default this will offset the original position by anything up to 30% distance. This is because the default value for 'Distance' is set to a maximum of 30% and 'Distance Random' is set to 100% meaning it can use any random value between zero and 30%. Similarly 'Direction Random' is set to 100% meaning it can offset in any direction. Temporarily set 'Distance Random' to zero. (This is in order to see exactly what the displacement is doing.)
- Set 'Direction Random' to zero. (In this example we do not require a random direction.) Now the bar will disappear because it is being displaced upwards in the default settings.
- Set 'Direction' to 180 degrees. Click on the compass button four times to get there quickly. Now the bar should reappear on the screen because it has been offset vertically down from the our off-screen position by the default 30%.
- Increase 'Distance' until the bar is approximately in the centre.

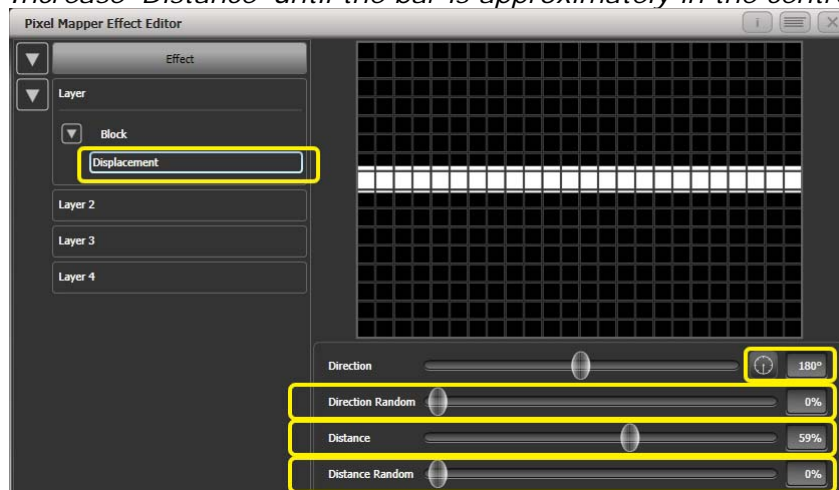

- 7> Add an Opacity animation.

Reduce 'In Time' and 'Out Time' to create a snapping effect.

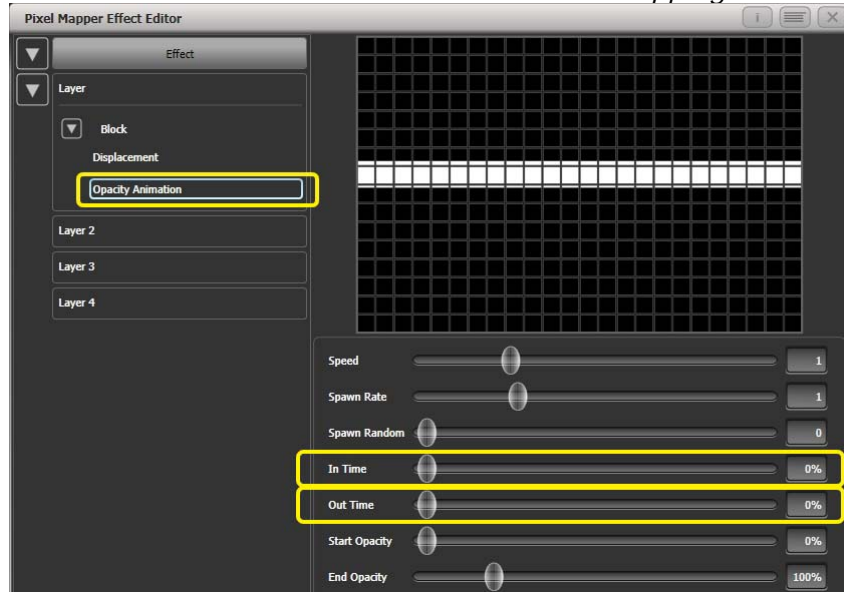

- 8> *Click on 'Displacement' in the Layer to get back to the controls for this animation again.*

Now increase 'Distance Random' to 100%. (This will make the bar draw at a random offset around the 'Distance' setting, in this case making it anywhere within the grid.)

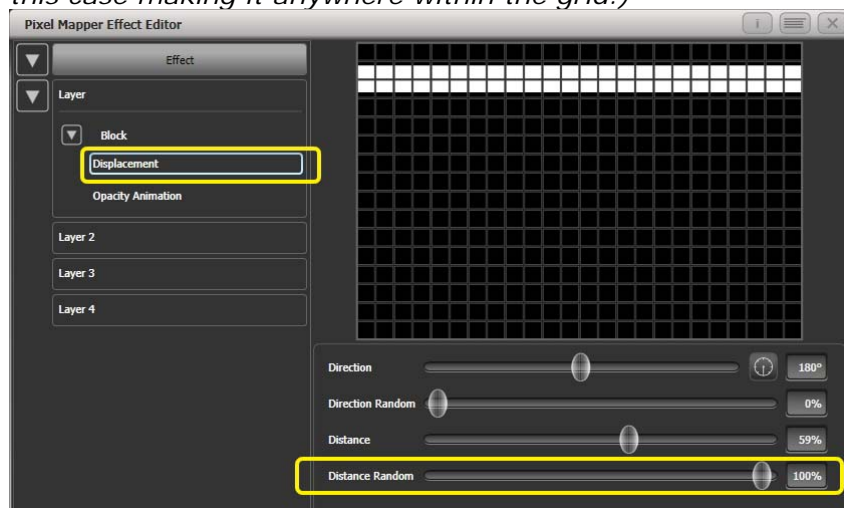

- 9> *Return to the Opacity animation controls and increase speed until you're happy.*
- 10> *At this point you may decide actually the effect would be better if it was a vertical bar. To make this easy we can make adjustments on the layer controls rather than on the individual element and animations:*

Select [Layer 1] to bring up the layer controls.

Change 'Rotation' to 90 degrees by clicking on the compass button twice.

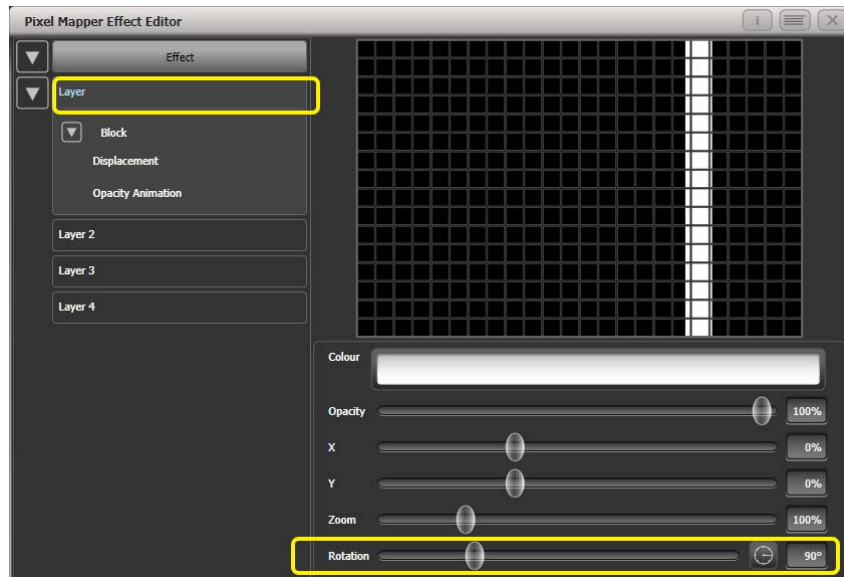

Now you have a vertical bar that draws randomly using a horizontal displacement. Similarly you can use the [layer] or [effect] controls to make global changes to X/Y position and Zoom allowing quick manipulation of entire effects.

6.6.7 **Spawn and Pre-Spool**

The director has asked for lots of animated spinning shurikens that slowly move across a backdrop while pulsating. It is a mystery why, but you know how it is with directors.

-
- 1> *Select a group with an appropriate layout.*
 - 2> *Add a Star element.*
Change 'Points' to 4 for a classic shuriken.

Reduce 'Zoom' so that we can fit lots of baby shurikens in the grid.

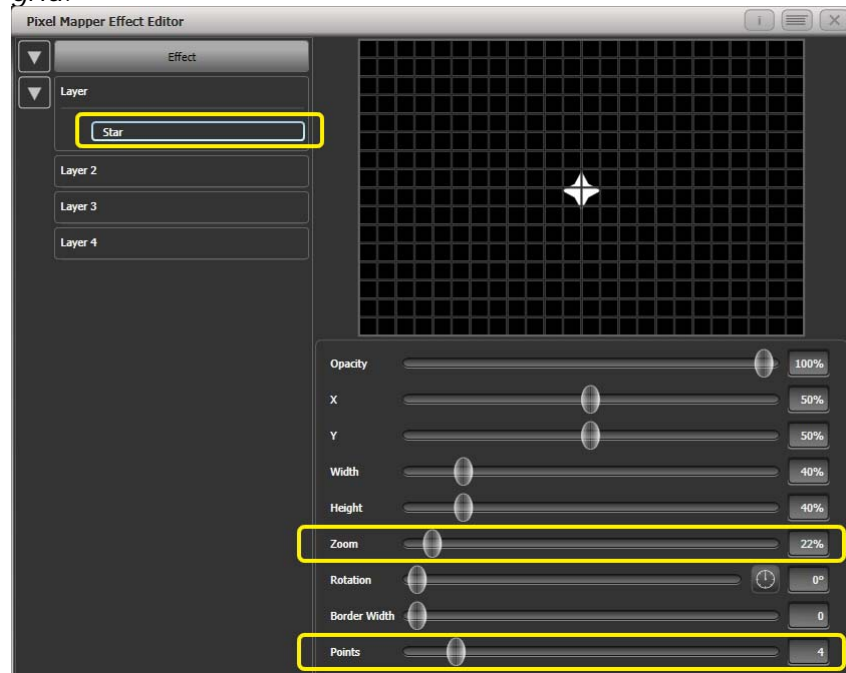

- 3> Add a Spin animation.
Reduce 'Speed' so they are relatively harmless.
- 4> Add a Linear Movement animation.
Slow it down so it looks like it is rolling along.
- 5> Select the Star element again and change 'X' so the shuriken starts further from the left and rolls along the whole grid.

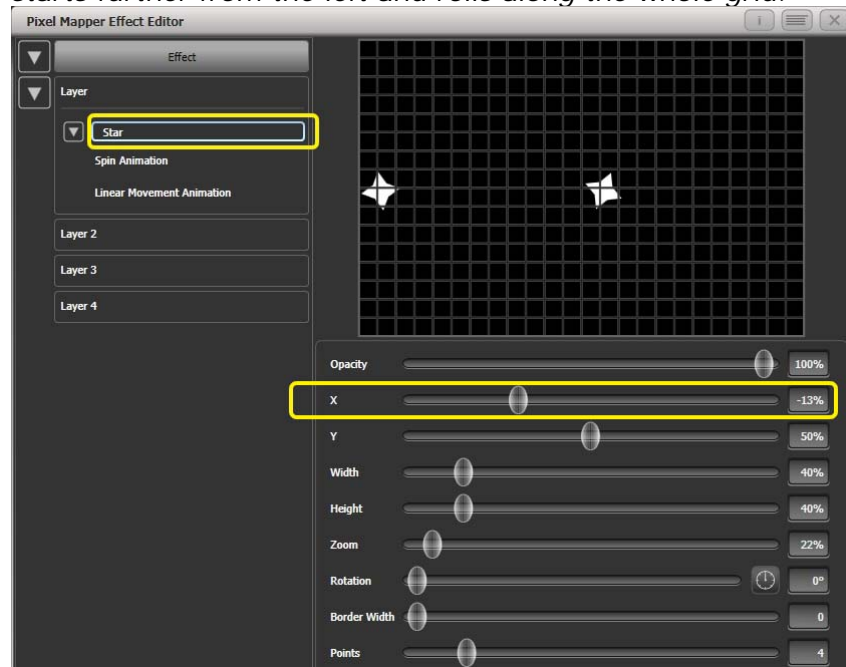

- 6> Add a Displacement animation.
Now each new shuriken starts rolling at a different height on the grid.
- 7> Go back to the Linear Movement animation and increase 'Spawn Rate' so that more shurikens are on screen at once. (This determines how frequently a new element appears.)

Increase 'Direction Random' slightly. (This will allow a random variation in the direction of travel based upon the 'Direction' value.)

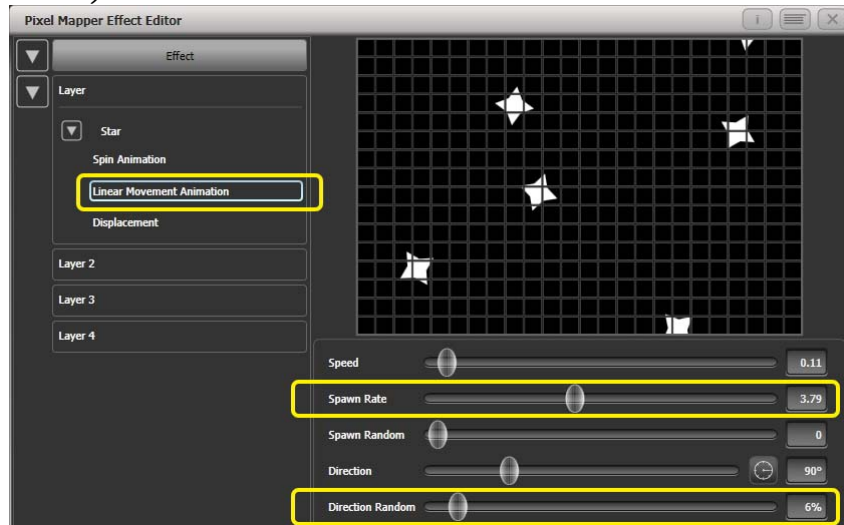

8> Add a Zoom animation.

Reduce 'Spawn Rate' to zero. (This is a special setting that will allow the zoom animation to run continuously during the life of a shuriken. If the rate is set to 1 it will only run once and the shurikens will quickly disappear as a result.)

Increase 'Out Time' to 100%. (This will make the shurikens pulse in and out with a 'bounce' type effect. I have no idea why they would be doing this in reality.)

Slow the zoom down a bit.

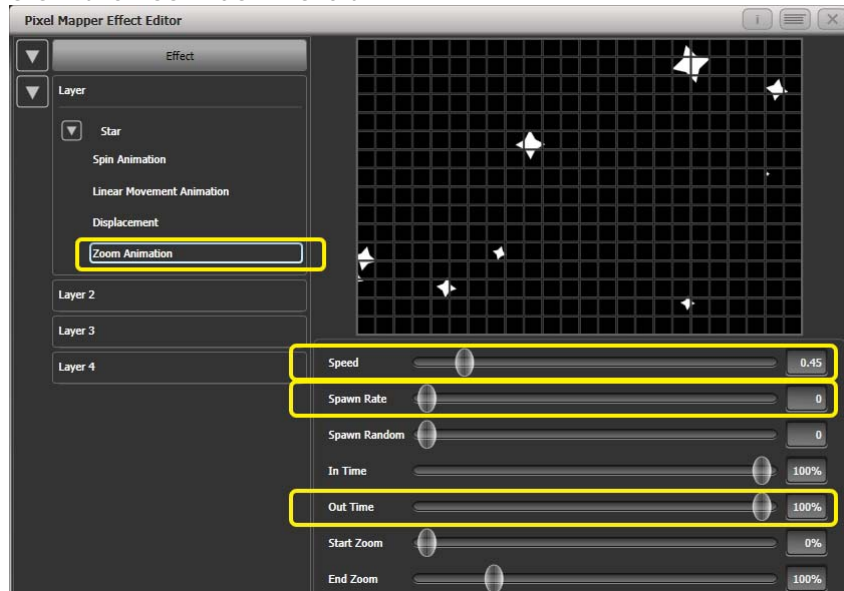

- 9> Click on [Effect] and set 'Pre-Spool' to zero. (This is to demonstrate the purpose of the property.)

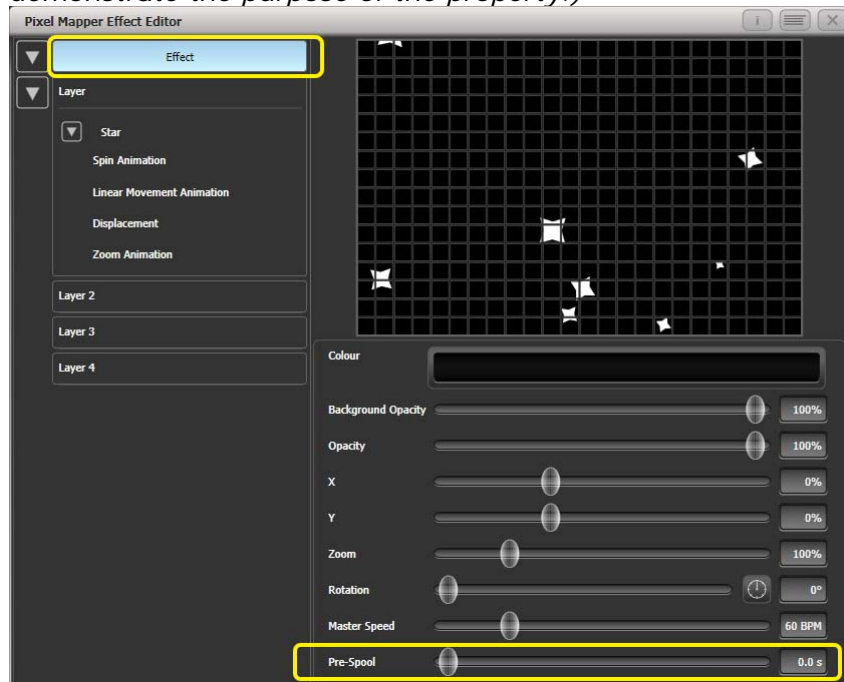

- 10> Store the cue.
- 11> Press clear, open the Pixel Mapper Preview workspace and fire the cue.
- You will notice that initially there are no shurikens on the screen and it takes a while to build up to a nice random collection. To fix that we can use 'Pre-Spool'.
- 12> Include the cue and open the Effect Editor workspace if it is not already.
- 13> Select [Effect] and increase the 'Pre-Spool' value to around 20s. (This means the software will pretend 20 seconds has already elapsed when the effect is started.)
- 14> Store the cue, clear, fire and view again in the Pixel Mapper Preview.

This time there should already be plenty of shurikens on screen. Pre-Spool is particularly useful for animations that rely on high spawn rates but run at a low speed.

7. Cues

So you've set up a great look on the stage, and you want to save it to use in your show.

There are three ways of saving looks on the Quartz .

Cue: This is a single look. It may contain movement in the form of shapes, and have fade in and fade out times.

Chase: This is a timed sequence of cues, often used for an individual effect.

Cue List: This is a linked sequence of cues, usually used to store and replay an entire show or an element of a show from a "go" button.

Chases and Cue Lists are covered in more detail in the following chapters.

When a Cue, Chase or Cue List is stored on a control, the control is called a **Playback**. You can store in several places:

- On any **fader handle** - the fader controls the intensity of fixtures (you can make the fader control other things using Playback Options).
- On a **touch button** in the Playbacks window – you can set whether the button latches or flashes the cue using Key Profiles
- On a **Macro/Executor button** – again you can use Key Profiles to set latch or flash.

Quartz has 600 playback faders, in 60 pages of 10. The optional fader wing can be added to give additional playback faders.

The cue functions on the Quartz are very powerful; the first part of this section explains the basics of how the console uses cues.

7.1 Creating a cue

7.1.1 How the Quartz works when programming

When you select one or more dimmers or fixtures for control, they are loaded into the *Editor*. You can then use the wheels and palettes to change the settings on the fixture. You can also apply shapes to it.

If a fixture is selected after you have changed some attributes then the current list of fixtures in the Editor is emptied and a new list is started.

All fixtures and attributes that have been edited since the last Clear are stored in the *Programmer*. The order in which you selected the fixtures is also stored, and is used with shapes and the Fixture Overlap function. When you record a cue, the contents of the Programmer are saved into the cue.

When you press Clear (by the numeric keypad), the programmer and editor are emptied. This makes sure you don't record fixtures you don't want. You also need to press Clear when you finish

programming, because any attributes in the programmer will override playbacks.

Fixtures which are in the programmer are shown in mid blue on the touch buttons. Attributes in the programmer (the things you have changed) are shown in cyan on the attribute displays.

Firing a cue does not place the values from the cue in the programmer (although the Include function lets you do this, see section 7.3.4 on page 157).

7.1.2 Creating a cue

- 1> *Press Clear to clear the programmer. This ensures that you are starting with a clean slate.*
 - 2> *Set up the look using the fixtures. You can save shapes in a cue. Remember that only fixtures which are selected or have been modified will be saved in the cue (in Record by Fixture mode).*
 - 3> *Press the Record button.*
 - 4> *Press the Swop button of an empty Playback to record the cue. The handles where you can record the cue will flash. You can also record a cue onto a touch button in the Playbacks window.*
 - 5> *Press Clear to clear the programmer. Repeat from 2 to program more cues.*
-

Other useful things to know about recording cues:

- Cues can be recorded into the playback faders, the macro/executor buttons and the onscreen Playbacks window.
- [Record Mode] lets you select Record By Fixture (all attributes of any modified or selected fixture are saved), Record By Channel (only modified attributes are saved), Record Stage (all fixtures with a non-zero dimmer channel are saved) or Quick Build (see next section).
- Record By Channel is useful if you want to layer multiple cues to create an effect.
- If you are recording a lot of cues, you can press the Menu Latch button to keep the Record Cue menu active. Press Exit to leave Record Cue mode.
- The bottom of the screen shows a legend for the playback. To set this, press [Set Legend], then the playback Swop button (or the touch select button), then enter a legend on the keyboard. Press Enter to store it.

- A Static Playbacks workspace is available to show the contents of the macro/executor buttons and (on the Tiger Touch) the 10 static playback faders.

7.1.3 Quick Build cues

Setting [Record Mode] to Quick Build allows you to build a cue from existing playbacks or palettes (you can also use the Include function to do this).

After setting the record mode to Quick Build, the console will wait for you to select playbacks or palettes.

To insert specific fixtures from a palette or playback, select the fixtures first and then select the palette or playback.

Press [OK] once you have selected all the playbacks or palettes required.

7.1.4 Using shapes/effects in cues

As you would expect, any shapes or Pixel Mapper effects you have set up will be saved as part of the cue.

You can create a cue which contains a shape with no base reference values; a shape cue like this can then be fired with other cues to overlay the shape on the cue and give you instant effects based around the settings in that cue. When recording the cue, use Record by Channel mode or use the "Off" function to remove the other attributes from the programmer as described on page 160.

7.1.5 Blind mode

Blind mode allows you to program cues without affecting the current look on the stage. This can be very useful for making changes during a live show. Your changes are still shown in the Visualiser window.

To select Blind mode, hold down the Avolites button and select the [Blind] option (some consoles also have a dedicated Blind button). The option shows [Active] or [Inactive].

Individual playbacks can be set to Blind mode using [Playback Options]. The playback will then output only to Visualiser, not to the stage.

You can fade your blind state to the live output by typing in a fade time number then pressing Avo+[Blind]. This allows you to recall several palettes together, or create a live state to be output without needing to save it to a cue.

7.1.6 Recording cue with a mask

You can set a mask when recording a cue so that only certain attributes are recorded, the same as you can when recording a palette. In the Record menu, select the [Set Mask] option.

There is an additional option [Clear Record Mask], if this is enabled the mask will automatically be cleared after this record operation. This is good to stop you accidentally leaving the mask set and causing havoc with future cues.

7.1.7 Convert cue to chase or cue list

If you want to convert an existing cue into chase or cue list by adding further steps, press Record, select the cue, then select [Convert to Chase] (or Cue List). The existing cue will become cue 1 and the contents of the programmer will become cue 2.

7.2 Using a cue

Because it's possible to play back a large number of cues at the same time, the console has to have rules on how it combines the output from different cues. These are called HTP and LTP rules.

7.2.1 HTP and LTP

Control channels are handled in two ways:

- Dimmer or intensity channels work on the principle of "Highest Takes Precedence" (HTP). If an HTP channel is active at different levels in several cues, the highest level will be output. When you fade out a cue, the HTP channels fade out with it.
- All other channels work on the principle of "Latest Takes Precedence" (LTP). The latest change takes over from any other values, so the most recent cue to be turned on is the one which is output. When you fade out a cue, LTP channels retain their values until changed by another cue.

7.2.2 Playing back a cue

To fire (play back) a cue, raise the fader. (Make sure there are no values in the programmer by pressing the Clear button, because anything in the programmer will override the playback).

- You can fire several cues at once.
- The HTP levels in the cue will be mastered by the fader level; for example if you set the fader at 50% then all HTP levels will be 50% of their programmed values.
- LTP channels are triggered as soon as the fader goes above 0%. If a fade time is programmed the LTP channels will start to fade; if there is no fade time they will snap to position (unless the cue is set to Mode 2; see the timings section 7.5 on page 162 for details of modes).
- You can Flash the cue by pressing the grey flash button. You can Swop (solo) the cue by pressing the blue Swop button (all other active cues will turn off while the button is pressed). This assumes you haven't reassigned the function of the buttons using Key Profiles, see below.
- You can Preload the cue by assigning the Preload function to the blue or grey buttons using Key Profiles. Preload sets the attributes of fixtures in the playback which are not currently active in any other playbacks. This is useful to avoid the fixtures visibly moving into position or changing colours or gobos when you raise the fader of the cue. To assign Preload, hold Avo Shift and press [Edit Key Profile], then press the button you want to assign (also see section 13.1.4 on page 233.) Note that this will assign the function to all buttons of the same type.
- You can fire a one-shot cue with timings by assigning the Go function to one of the handle buttons using Key Profiles. This allows you to fire the cue without needing to hold down a button while the timing completes. You can also fire the cue again without needing to release it.
- You can set playbacks to high priority if you do not want them to be overridden by other playbacks using the same fixtures. For example, if you have a couple of fixtures acting as a

spotlight, but they are also programmed into some colour washes, you probably want the spotlight cue to take priority over the colour washes. See section 7.6.1 on page 167.

7.2.3 Changing playback pages

You change playback pages using the +1 and -1 buttons to the right of the playback faders. You can also touch the 'Pages' roller graphic and enter a page number.

- If you have stored cues on the touch select buttons, you select different pages using the Playbacks page touch buttons.
- Playbacks which are fired when you change page remain active. If you want to fire a cue on a fader which is already up from a previous page, lower the fader to zero then raise it again. The cue from the previous page will stop and the cue from the new page will fire.
- If you return to a page with an active playback, the fader will not resume control of the playback until it matches the current level of the playback. This prevents the playback level jumping when the fader is first moved. If a playback is active from another page the display area is purple and shows the page number at the top in light blue. You can change this behaviour using the [Playback Paging] user setting, see section 13.1.3 on page 277 .
- You can set a legend for each playback page. The legend is shown on the 'Pages' roller on the screen. Use [Set Legend] from the main Program menu then [Page Legends]. While in this menu you can change the page to set legends for different pages. The 20 executor buttons on the top right of the console can be paged using two of the macro buttons. The page change macros are part of the fixture library; if you do not see the macros, download and install the latest library.

7.2.4 Viewing active playbacks

The Active Playbacks window shows details of which playbacks are active. When you have a number of layered playbacks with different effects, this provides an easy way to see which playback is causing which effect. Each button shows the playback legend, which page they are from and which attributes are affected. To show the window press Window Open, [Open Workspace Window], [Active Playbacks].

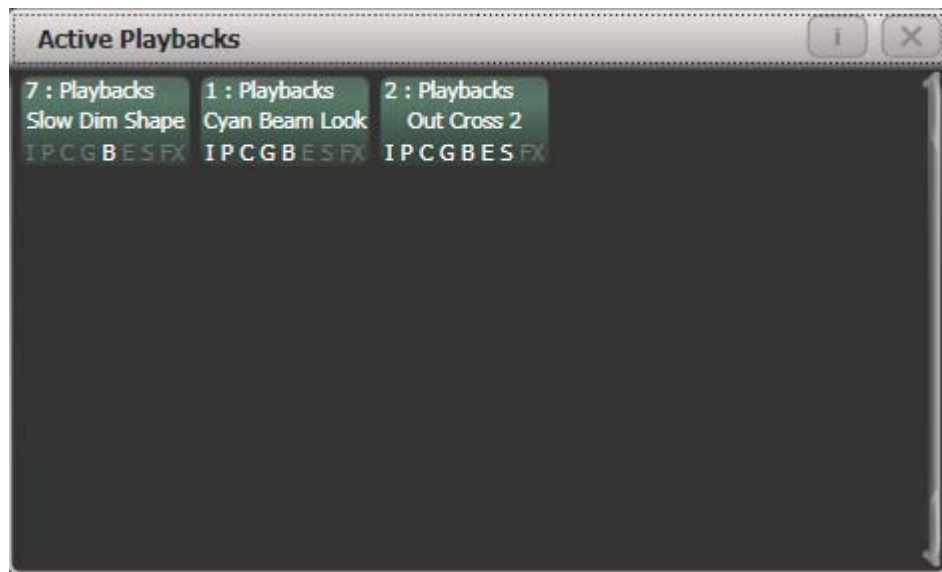

Click on a playback to instantly kill it. You can also press [Playback Options] followed by the playback in this window to change parameters of the playback.

7.2.5 Speed and Size Masters

Playbacks can be assigned to Speed and Size Masters which allow you to modify the speed and size of shapes or effects stored in a cue (or in the case of chases, to modify the speed of the chase). This is really useful to modify the look when several playbacks are running at the same time.

A playback is assigned to a Speed Master by pressing [Playback Options] then [Effects].

The following speed sources are available:

- Local (no Speed Master)
- BPM 1-4 (override the local speed with a fixed value from the master)
- Rate 1-4 (proportionally modify the local speed using the master)

Also four different Size sources are available.

The 4 different BPM Masters and 4 different Rate Masters allow you to individually control the speed of different playbacks.

You will also need to assign one or more handles to act as the master faders; to do this, switch the console to System mode and select [Assign Mastering]. Special key profile options are available for Speed Masters, BPM Masters default to Tap Tempo.

Speed and size masters can have various scales, 0-100%, 0-200% and so on. A 0-200% speed scale would allow you to slow down and speed up the speed to double the programmed setting. Scales are set by selecting [Playback Options] then press the Select button of the master.

Tap Tempo can be used on Rate Masters. This lets you synchronise playbacks while still allowing control using the fader and wheels. Tapping the tempo of a Rate Grand Master will update and synchronise all rate masters. If you tap a tempo it is shown in the

BPM display of target playbacks. The tapped tempo is mastered by the fader position and scale, so if you tap 100BPM but then set the fader to 50%, you will get 50BPM.

7.2.6 Releasing running playbacks

You can release a running playback to its previous state by pressing the Release button, then the Select button of the playback to be released. Channels will release back to their state in the previous playback until no playbacks are left to be released. If the [Release to Home] setting on the Release menu is Enabled, channels will go to the power-on state, which you can program (see next section). If the option is disabled, channels will remain in the state of the last playback. You can release all running playbacks by pressing the Release button then [Release all playbacks].

You can also configure the key profile so that the blue or grey buttons can be used to release the playback.

Channels will always release with a fade time, this defaults to 2 seconds but you can change it using [Master Release Time] in the Release menu.

- You can instantly kill a playback by pressing Avo+the swop button of the playback.
- You can set a mask so that only certain attributes release from the playback when the playback is killed. This uses the [Release Mask] option in the Playback Options menu (see section 0 on page 167). Normally all attributes will remain in the state last used in the playback – for cues which trigger strobing or other effects this might not be what you want.

7.2.7 Releasing a whole page of playbacks

You can use the Release function to release a whole page of playbacks in one operation. Press Release then the Goto Page button, or touch the current page in the playbacks view. You will get the following options:

[Release this Page]: releases all active playbacks on the current page and playback fader group

[Release Playbacks Not On This Page]: releases any active playback on the same fader group from another page

[Release All Playbacks In This Group]: releases any active playback in the fader group.

“Fader Group” refers to a particular area of the console, for example the main faders below the screen on a Tiger Touch or the top row on the left hand side of the Arena.

7.2.8 Release mask - releasing individual attributes

You can release individual fixtures or attributes, and remove fixtures from shapes in playbacks using the release mask. There is a Global release mask which affects all release operations, or you can set a Local release mask which affects only the current playback.

Global release mask

If no local release mask is set for the playback, attributes release according to this mask. The default is for no attributes to release.

To set the mask, press Release then [Global Release Mask]. The softkey shows which attributes are enabled.



Local release mask

To set the local release mask for a playback, select [Playback Options] and press the select button of the playback. Then press [Release Mask]. If the option is set to [Mask Source Global] then press the option again to change to [Mask Source Local].

•

7.2.9 Programming the Release / Power On state

You can program the state which fixtures will go to at power on, or when all playbacks are released. It can be useful to program this as a general lighting state so that there is some light on the stage when the console powers up, or when all playbacks are released.

The release state can be programmed in Shared mode or Individual mode. In Shared mode you just have to set the desired state for one of each type of fixture, and that state will be used for all fixtures of that type. In Individual mode, the state of each fixture will be recorded individually as you have set it.

-
- 1> Set up the look you want.
 - 2> Press Record , then Release.
 - 3> Select [Shared values] or [Individual values].
 - 4> Press the [Record] softkey.
 - 5> The Release state is saved.
-

- To test, fire some playbacks, then release them by pressing the Release button followed by the select button of the playback. The fixtures should return to your programmed release state.

7.2.10 Turning off individual fixtures

You can turn off individual fixtures or certain attributes of them using the Off menu. This will cause the attributes/fixtures to release to their previous state before the playback was fired.

Press Off button followed by a playback to open the 'Off Playback with Mask' menu. Select the fixtures to be turned off, set mask as required and then press [Off] to turn the fixtures/attributes/shapes off.

Note that on other Titan consoles that do not have separate Release and Off buttons, pressing Off followed by a playback will release it. In these cases select the softkey [Off Playback Values] then select the playback.

7.3 Editing cues

7.3.1 Editing a cue by merging

You can edit any part of a cue you have already saved simply by making the changes and saving the new information on top of the cue.

-
- 1> *Press Clear to empty the programmer.*
 - 2> *Fire the cue you want to edit, so you can see what you are doing. Kill all other cues to avoid confusion.*
 - 3> *Select the fixtures you want to change, and make the changes.*
 - 4> *Press Record Cue.*
 - 5> *Press the Swop button for the cue you are editing.*
 - 6> *Press [Merge] (the cue being edited is highlighted on the screen).*
 - 7> *The console will merge the existing cue with your changes. Unchanged information is not affected.*
-

- If you want to overwrite the cue entirely, use the option [Replace] at step 6 – but remember that unless you are in “Record by Stage” mode, any fixtures you haven’t changed won’t be saved.
- To speed up editing, you can set the console to “Always Merge” the cue. This is option A in the User Settings (press Avo and select User Settings).
- You can also press the Swop button for the cue a second time to select the “Merge” option (quicker than selecting the softkey Merge option).

7.3.2 Updating stored values and palettes used in a cue

If during a show you need to quickly update a cue, or a palette used in a cue (for example you fire a green cue and the fixtures turn out to be not quite the right colour) the Update function lets you quickly update either the cue itself or the palettes used in the cue.

For instant update of a fired cue, change the fixture settings and press Update twice.

-
- 1> *With the cue fired, select the fixtures and change them to the settings you want to store (e.g. the right green colour).*
 - 2> *Press Update.*
 - 3> *Press Enter to immediately store the new values to the cue. Alternatively, the softkeys show a list of palettes and playbacks which can be updated. Select or deselect these as required.*
 - 4> *If you have used the softkey options, press Enter to complete the update.*
-

- You can also select which palettes will be affected by pressing the palette’s button twice.
- If you manually set an attribute in the cue which was set by a palette, then press Update-Update, the palette will be removed from the cue. If you want to update the palette, use the softkey options or press the palette button.

- If you change an attribute using a different palette, the new palette will be stored instead.

7.3.3 Playback and Cue view

To see the current timings of the cue, touch the playbacks display for the fader, or press Window Open then the swop button of the playback you want to view. The screen will show details of the delay, fade, overlap and curve settings for the cue. You can touch each item to enable editing.

The Times button on the left removes some of the columns, showing only timing related information.

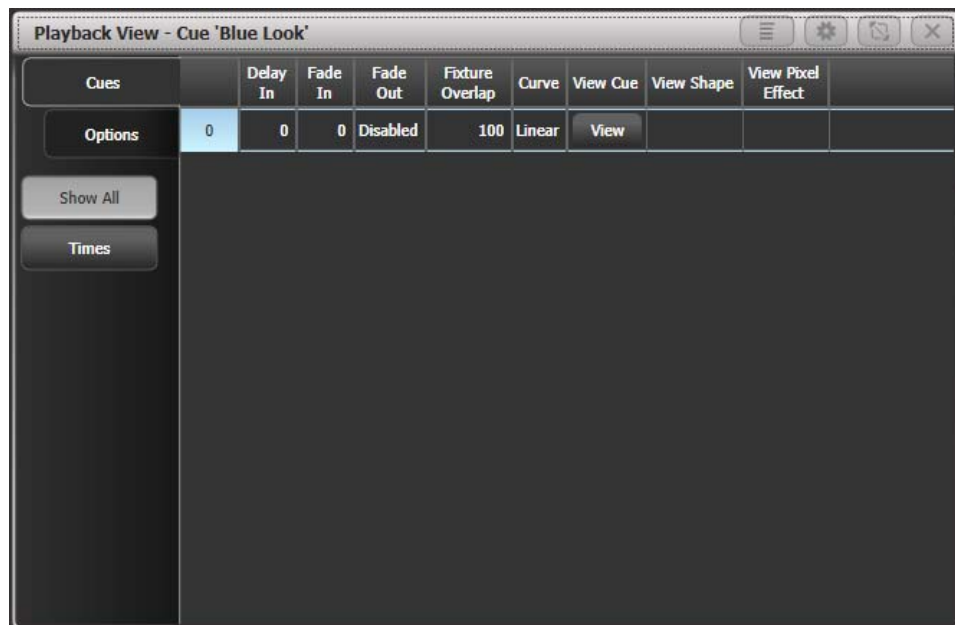

You can configure which columns are shown in the Playback View using the [Edit Columns] context menu button. Once you have set a view you can save it to a filter button which appears below the Times button on the left.

- 1> Press [Edit Columns] on the context menu.
- 2> Using the softkeys, enable or disable the columns to get the view you want.
- 3> Press Record. An [Add] button will appear at the bottom of the screen.
- 4> Press the [Add] button to create a filter button for this view.
- 5> You can set a legend and colour halo for the filter button using the normal [Set Legend] function.
- 6> You can delete filter buttons by pressing Delete then the button.

If you touch the View button at the right hand end of the row or the [View Cue] context button, the Cue View window opens, showing you details of the settings individual timings for all the fixtures in the cue.

The Cue View has four different views: Levels, Palettes, Times, Shapes. Views are selected using the context buttons to the left of the menu buttons.

- The **Levels** view shows the individual attribute values for each fixture.
- The **Palettes** view shows which palettes have been used to record the cue. Palettes are shown by their legends. Where an absolute value was saved rather than a palette, the value is shown instead. Again you can edit or remove the values.
- The **Times** view shows individual attribute timings for fixtures. If global timings are set, no times are shown in the cue view.
- The **Shapes** view shows which attributes of each fixture are running shapes.

Cue View - Red Beam Look																
Attributes		Number	Order	Dimmer	Shutter	Pan	Tilt	Colour Macros	Colour Func	Colour	CTO	White	Cyan	Red	Magenta	Green
All	I	Robin600ES	101	1	100	Open	46.02	23.66	Fixed	Open	0		0		0	
P	C	Robin600ES	102	2	100	Open	48.68	23.66	Fixed	Open	0		0		100	
	G	Robin600ES	103	3	100	Open	51.32	23.66	Fixed	Open	0		0		0	
B	E	Robin600ES	104	4	100	Open	53.98	23.66	Fixed	Open	0		0		100	
	S	Robin600ES	105	5	100	Open	46.02	23.66	Fixed	Open	0		0		100	
Fixture Type		Robin600ES	106	6	100	Open	48.68	23.66	Fixed	Open	0		0		0	
All Fixtures		Robin600ES	107	7	100	Open	51.32	23.66	Fixed	Open	0		0		100	
BB4		Robin600ES	108	8	100	Open	53.98	23.66	Fixed	Open	0		0		0	
Robin 600 LED Wash		Robin600ES	109	9	100	Open	46.02	23.66	Fixed	Open	0		0		0	
Robin 600E Spot		Robin600ES	110	10	100	Open	48.68	23.66	Fixed	Open	0		0		100	
		Robin600ES	111	11	100	Open	51.32	23.66	Fixed	Open	0		0		0	
		Robin600ES	112	12	100	Open	53.98	23.66	Fixed	Open	0		0		100	
		Robin600ES	113	13	100	Open	46.02	23.66	Fixed	Open	0		0		100	

Filter which attributes you are shown using the All/PCGBES buttons in the top left corner.

Filter which fixtures you are shown using the fixture type buttons on the left.

You can edit or remove one or more individual control values in the cue:

Touch or drag over the required control values in the grid to select them – they will be highlighted in blue.

The softkeys then give you available settings for that control value, or you can directly edit values by typing numeric values and pressing enter.

You can delete the selected control(s) using the [Delete] softkey.

You can turn attributes On and Off using the Off button and the [On] softkey. Off temporarily removes a value from the cue, it can later be restored using [On].

You can remove a fixture completely from the cue by selecting the fixture then pressing the [Remove Fixtures] softkey.

Any changes take immediate effect.

- The context menu option View Tracking Values allows you to highlight in grey values which are tracked from previous cues.

7.3.4 Using parts of existing cues - the Include function

The Include function lets you load selected parts of a cue back into the programmer. (Normally, only manual changes to fixtures are put in the programmer). You can then use this to make a new cue. This is useful if you want to make a cue which is similar to one you already have, or to build a new cue from various parts of other cues. It's also useful when editing shapes in cues.

There are two modes, Quick Include and Advanced Include. Quick Include simply reloads the whole cue. Advanced Include allows you to specify which attributes of which fixtures you want to load into the programmer. So, for example, if you have a cue which contains position, colour and gobo information for 8 fixtures, you can use the include function to load only the colour information for 4 of the fixtures into the programmer. You could then Include position information from another cue into the programmer, and build up a new cue using information from several existing cues.

If you Include a chase or cue list, the screen shows you a list of the cues within it, and you select the one you want to Include using Wheel A or by touching the cue. You can also type in the cue number to Include.

-
- 1> *Press Include (above numeric keypad).*
 - 2> *Press [Quick Include] or [Advanced mode] if you want to change the mode.*
 - 3> *Press the Swap button of the cue you want to include into the programmer. If you are in Quick Include mode, this Includes the cue and finishes.*
 - 4> *If you are in Advanced mode, all fixtures in the cue will be selected. If you don't want them all, deselect the fixtures you don't want. The fixtures in the cue are highlighted on the HUD and on the fixture buttons.*
 - 5> *Use [Set Mask] or the Attribute Bank buttons to select which Attributes you want to include (All are included by default – Softkey C turns them all off and D turns them all on). Softkey E lets you include or exclude Shapes from the cue.*
 - 6> *Press Enter. The selected attributes of the selected fixtures will be loaded into the programmer.*
 - 7> *Repeat from 2 to include other attributes from the same fixtures, or repeat from 1 to include other fixtures.*
-

- In Quick Include mode, you can set a mask for the include by pressing one or more of the attribute bank buttons before you select the cue to include.

7.3.5 Removing attributes from cues using “Off”

The “Off” button allows you to remove an attribute which has been stored in a cue, as if you'd never recorded it.

For example, suppose you recorded a cue which had scans at a certain position, with the colour set to green. If you later decide that you don't want a colour recorded at all in the cue, so that the colour set by previous playbacks will remain, you set the colour values to Off in the programmer, which when saved will remove those values from the cue. You can also use the Off function to remove complete fixtures from a cue by selecting all the attributes.

Setting an attribute to Off is not the same as recording an attribute at zero, since this would change the attribute when the cue was fired. It is the same as excluding that attribute using the mask when recording, so the attribute will remain unchanged when the cue is fired.

-
- 1> *Press Off followed by the playback to be changed. (On consoles which do not have a Release button, you need to press Off, then [Off Console Values], then the playback)*
 - 2> *Select fixtures to be set to Off.*
 - 3> *Set the attribute mask to determine which attributes will be set to Off.*
 - 4> *Press the [Off] softkey.*
-

You can also use Include to set values to Off.

-
- 1> *Use the Quick Include function (described in previous section) to load the cue you want to change into the programmer.*
 - 2> *Press the Off button to display the Off menu.*
 - 3> *All fixtures in the cue will be selected. If you don't want to change them all, deselect the fixtures you don't want.*
 - 4> *Use the softkeys to select which Attributes you want to remove.*
 - 5> *Press Record Cue, then set the record mode to [Replace], and press the Swap button of the cue to update it.*
-

- You can merge "Off" attributes into a cue without including it first.
- You can also remove attributes from palettes using the Off function.
- Another way to remove attributes is from the Cue View window. See section 7.3.3 on the previous page.
- Attributes set to Off can be restored to their previous value using the On function. Set the attribute to On and merge it into the cue.

7.4 Copying, moving, linking and deleting

7.4.1 Copying or moving a cue

Using the Copy button you can make a copy of an existing cue, move it to a new playback, or create a new playback which is linked to the existing playback. You can copy, move or link multiple playbacks (which may be cues, chases or cue lists) in one operation.

Move is useful for tidying up the console. Linked cues are handy if you want a cue to appear on more than one page for ease of operation; also the linked cue can have different timings and playback options from the cue it's linked to.

-
- 1> *Press the Copy button.*
 - 2> *Select [Copy], [Move] or [Link]. Pressing the Copy button again will also toggle these options.*
 - 3> *Press the Select button of the cue you want to copy/move/link. You can select a range of playbacks by holding the first button while pressing the last in the range.*
-

4> Press the empty Select button where you want it to go.

- The Menu Latch button latches the Copy/Move/Link menu, so you can keep copying, moving or linking things without having to keep pressing the Copy button. Press Exit to unlatch.
- [Retain Layout] or [Bunch Up] is used when copying a group of cues with empty playbacks in the group – you can either keep the empty playbacks, or bunch up the used playbacks together.
- When in Copy mode, option [Copy Legends] can be changed to [Don't copy legends] so that the copied cues are given default legends.
- When in Move mode, [Swap Items if Required] will attempt to reposition any existing playbacks which are in the way of the move. This is useful when rearranging playbacks on a page which is nearly full.

7.4.2 Deleting a cue

To delete a cue:

- 1> Press the Delete button.*
 - 2> Press the Select button of the cue you want to delete.*
 - 3> Press the Select button again (or press Enter) to confirm the delete.*
-

- Instead of deleting the cue you can select [Unassign], this will remove the cue from the handle but retain it for future use. Go to the Show Library to reuse unassigned cues.
- Press Menu Latch to keep the delete mode active. You can keep deleting using steps 2 and 3 without having to keep pressing the Delete button. Press Exit to leave latched delete mode.

7.5 Cue timing

The console allows a wide variety of timing functions to be set for each cue.

7.5.1 Setting fade times and Overlap for a cue

When programming a cue, you can set a delay, fade in and fade out time for each attribute of each fixture, or globally for the cue. Shapes in the cue will also be affected, depending on the fade mode.



If you enter times more than 60 seconds, Titan will automatically split the time into minutes and seconds, for example enter 115 to set 1:15 (1min 15 seconds). Entering more digits will set hours, minutes, seconds.

You can delay the fade times between fixtures in a cue so that the cue is applied sequentially to each fixture. This is called Fixture Overlap and can create some amazing “peel off” or “roll” type effects with no programming at all.

In the diagram below, the top picture shows how the LTP channels change when used with delay, fade and fade out times. The second picture shows how the HTP channels change. The third and fourth

pictures show what happens to the LTP channels when fixture overlap and attribute fade are used.

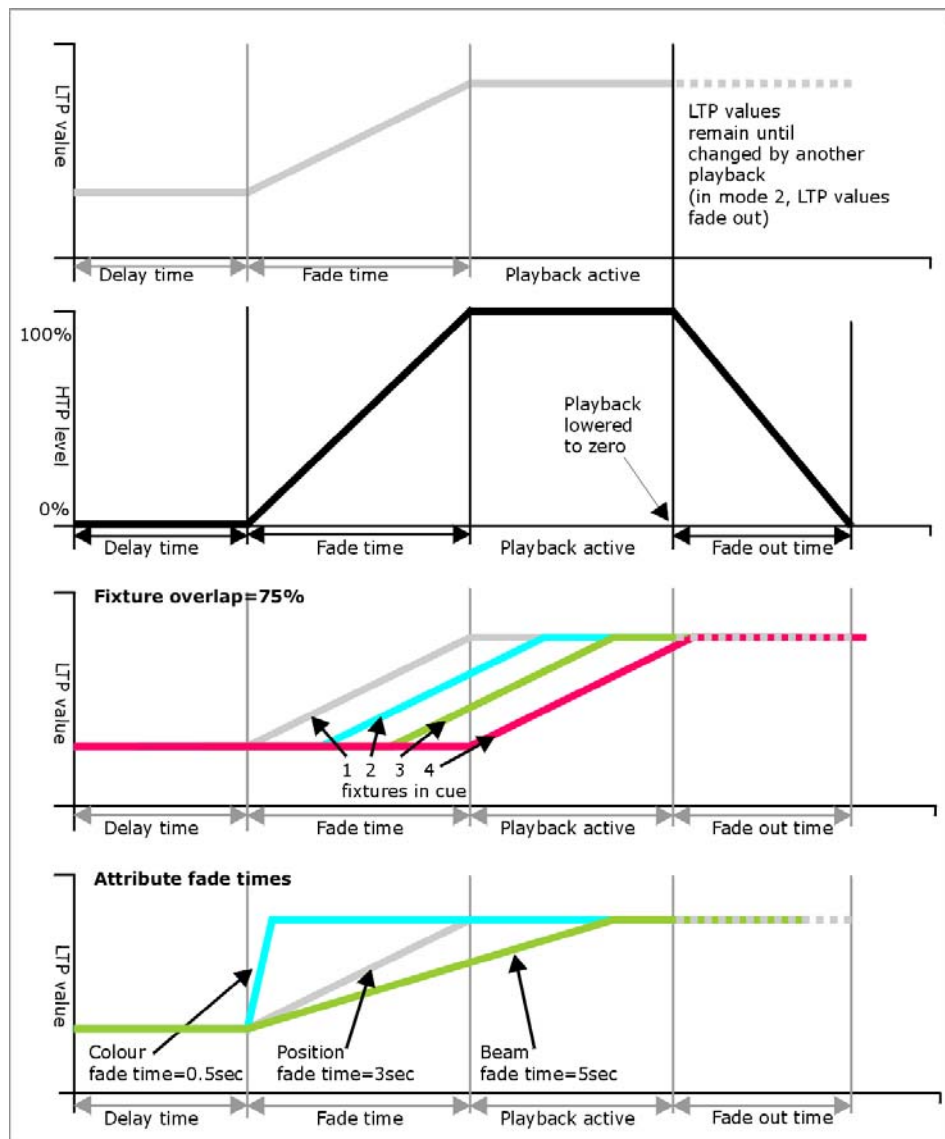

All times which you have set while programming the fixtures/dimmers will be recorded when you save the cue.

You can also edit times of a cue you have already saved like this:

- 1> Press [Edit Times] at the top level menu.
- 2> Press the Swop button of the cue.
- 3> Press [Fade Mode x] to set the cue mode. This sets how the times are used, see below.
- 4> Press [Delay time] to set the delay before the cue starts, [Fade time] to set the fade-in time of the cue, and [Fade out time] to set the fade-out time of the cue.
- 5> Type the new time (in seconds) using the numeric keypad and press Enter to save it.
- 6> Press [Fixture Overlap] to change the overlap, then enter 0-100 on the keypad. 100% means all fixtures fade together. 0% means that the first fixture will finish its fade before the next one starts. 50% means that the 2nd fixture will start fading when the first one is half way through its fade. The order of the

fixtures is set by the order you selected them (but you can change this, see section 7.5.2).

7> Press Exit to get out of Edit Times mode.

- You can also set independent times for the IPCGBES attribute groups, and for each individual attribute, see next section for details of this.
- You can quickly set times from the keypad using the Time button, e.g. TIME 5 AND 2 sets 5 sec fade in and 2 sec fade out. (The Time button is the button previously labelled Set on Titan Mobile and Sapphire Touch, and Next Time on Tiger Touch and Pearl Expert).

The times you enter are affected by the cue mode which is set using the [Fade Mode] option. This option can also be set from Playback Options Fader Mode:

- Mode 0 – Channels will fade in as set by the fade time. The Fade Out time is ignored. If times are set to zero, the HTP channels fade in with the 0-100% position of the playback fader and the LTP channels will snap.
- Mode 1 - Channels fade in as set by the fade time. HTP channels fade out as set by the fade out times (LTP channels remain as set in the cue). If times are set to zero, the HTP levels will fade in and out with the fader and the LTP channels will snap when the cue is fired.
- Mode 2 – Channels will fade in as set by the fade time. The Fade Out time is ignored. However, the fade will stop when the fader position is reached, so if the fader is set to 50%, the attributes will stop half way to their programmed position. You can reverse the fade back to the original position by moving the fader back. If times are set to zero, both HTP and LTP channels are controlled by the fader position. In this mode LTP channels revert to their previous settings when the cue is deactivated. Mode 2 is useful when used with a pan/tilt cue for manually tracking a spot across a stage or down a catwalk using the fader position, or for colour mixing using RGB fixtures.
- Mode 3 - Crossfade cue. All channels, including intensity channels, will fade to the settings in the new cue. All other cues fade out and all other active playbacks become inactive; if you need to re-fire a playback, take the fader to zero and put it up again.
- If the cue includes shapes, then the shape will change with fade times. The changes will be timed for a Mode 1 cue and controlled by the fader position for a Mode 2 cue. This allows you to create a shape which gets bigger or faster as you push up the fader.

7.5.2 Changing fixture order

You can change the order of the fixtures stored in a cue. Normally this is set to the order in which you selected the fixtures when the cue was created, but you might want to change this (for example to pair up fixtures so they move together when using Overlap).

- 1> Press [Edit Times] at the top level menu.
- 2> Press the Swop button of the cue to be changed.
- 3> Press [Fixture Order].
- 4> Set the sequence number to start from using option A.
- 5> If you want the sequence number to increase automatically, set [Autoincrement] to On. If you want some fixtures to have the same sequence number, set it to Off.
- 6> Touch the Select buttons of the fixture(s) you want to place in that position in the sequence. The sequence number is shown in the top right hand corner of the fixture select touch buttons.



- 7> Press Exit to finish.

- You can set several fixtures to have the same sequence number. This means, for example, when used with Overlap they will all do the same thing at the same time.
- You can remove a fixture from the sequence by turning off [Autoincrement] and pressing the fixture button twice. The fixture sequence will show X. Touch the button again to put it back in the sequence.

7.5.3 Setting attribute fade times for a cue

You can set individual fade times for each attribute group (such as Position). If you set a time, it overrides the normal times.

To set an attribute group fade time:

- 1> Press [Edit Times] at the top level menu.
- 2> Press the Swop button of the cue to be changed.
- 3> Press the Attribute Bank button (right hand side) for the attribute you want to change.
- 4> Press [Delay] to set delay time or [Set fade] to set fade time.
- 5> Type the new time using the numeric keypad and press Enter to save it, or press [Use Global] to delete the attribute times and go back to the normal times.
- 6> Press Enter to save the changes.

You can take this even further and set individual fade times for each fixture. When you select the cue to be changed, you will see that all the fixtures in the cue are selected. To set attribute times for only certain fixtures, change the fixture selection using the Swop buttons.

The Cue View window will display when editing cue timings to help you see what you are editing. You can touch fixtures or attributes in the grid to select which items are going to be edited.

Press the ALL button to select all fixtures in the cue.

When you are in the Set Attribute Times menu you can only select fixtures which are in the cue you are editing.

7.5.4 Editing times in the programmer

You can check and edit the times which are set in the programmer before saving a cue. You can also set times into the programmer and merge them into cues as a quick way of updating times, just like you would with attribute values.

Press the Time button to access this menu.

- On Titan Mobile and Sapphire Touch, the Time button is the key above Clear (previously labelled SET). On Pearl Expert and Tiger Touch it is the key previously labelled NEXT TIME.

The menu allows you to set cue times, or times for all attributes of a fixture, attribute groups or individual attributes.

Using the Time button there are various quick shortcuts to setting times.

- TIME 5 = 5 sec fade in.
- CUE 3 TIME 5 = 5 sec fade in on connected playback's cue 3.
- TIME FIXTURE 5 – 5 sec fade in for all attributes of selected fixtures.
- TIME FIXTURE G 5 – 5 sec fade in for gobo attribute group of selected fixtures.
- TIME FIXTURE @B 5 – 5 sec fade in for attribute connected to wheel B on selected fixtures.
- 5 @ 3 – 5 sec fade in, 3 sec delay.
- 5 AND 2 – 5 sec fade in, 2sec fade out.
- 1 THRO 10 - times spread across fixtures according to selection order.

Individual attribute times can also be set from the wheels, using the [Wheels] softkey option on the root menu.

7.6 Playback options

To set options for a cue, chase or cue list, press [Playback Options] on the root menu, then press the select button of the playback to be edited. A list of option categories will open in a list on the softkeys.

You can also open a touch-friendly version of the playback options from the Playback View by pressing Window Open then the select button of the playback. Then press the Options tab on the left of the playback view.

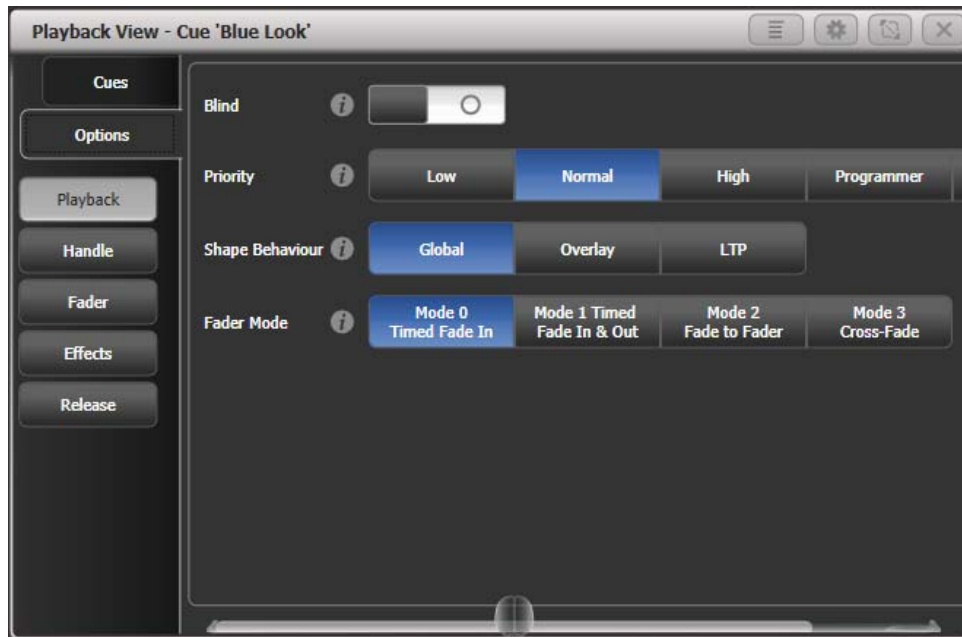

Click on the  button for a help window on each setting.

7.6.1 Playback options - Playback

Blind: Sets this individual playback to Blind mode. The playback will then output only to Visualiser, not to the stage. This can be very useful if you need to program and test a cue during a live show.

Priority: allows you to configure how playbacks will behave if you turn on two playbacks controlling the same fixture. The priority can be set to Low, Normal, High, Programmer or Very High. (Programmer gives the same level as manually set attributes in the programmer). If a fixture is being controlled by a playback and you turn on a playback of the same or higher priority, then the new playback will take over. However, if the new playback is set to lower priority than the first playback, the fixture will not change.

This is useful if, for example, you've programmed looks using all your fixtures, then you decide you want a couple of them to spotlight a singer. If you set the Spotlight playback to be high priority, then while it is active no other playback will affect the spotlight fixtures.



Priority is useful when using Swop buttons for strobe-type effects where you want to black out everything else. If you have a position shape running on other fixtures, you don't want that to stop during the Swop, or it will look messy when you release the Swop button. So set the shape playback to have a higher priority than the strobe playback, and it will keep going during the strobe and continue smoothly when you release the Swop button.

- Attributes set by manually applying a palette to a fixture will override all playback priorities except Very High.

Shape behaviour: Controls the behaviour of Key Frame Shapes in this playback.

Global - Use global setting from User Settings.

Overlay - Shape continues to run over changes to attributes

LTP – If attributes are changed, the shape will stop running on those attributes

Fader mode: This is the same option as set in the [Edit Times] menu.

Mode 0 – Channels fade in as set by the fade time. The Fade Out time is ignored. If times are set to zero, the HTP channels fade in with the 0-100% position of the playback fader and the LTP channels will snap.

Mode 1 - HTP channels fade in and out as set by the fade out times (LTP channels fade in but then remain as set in the cue). If times are set to zero, the HTP levels will fade in and out with the fader and the LTP channels will snap when the cue is fired.

Mode 2 – Both HTP and LTP channels follow the fader position. Useful when used with a pan/tilt cue for manually tracking a spot across a stage or down a catwalk using the fader position or for mixing colours on RGB fixtures.

Mode 3 - Crossfade cue. All channels, including intensity channels, will fade to the settings in the new cue. All other cues fade out and all other active playbacks become inactive; if you need to re-fire a playback, take the fader to zero and put it up again. Useful for setting a video playback state.

7.6.2 Playback options - Handle

Handle paging: allows you to lock the playback on a handle so that it always appears on that handle no matter what page is selected.

This is useful if you have some general playbacks you want on every page, without having to copy the playback onto each page.

Unlocked – playback will change with the pages as normal

Transparent lock - playback will appear on all pages when the handle is unprogrammed

Locked – this playback will appear on all pages. Playbacks programmed on this handle on other pages will not be accessible.

Key profile: Sets the key profile individually for this playback. Global sets the key profile back to the global setting for playbacks.

7.6.3 Playback options - Fader

Fader mode: same as in Playback tab, see above

Shape size: sets whether the fader position affects the size of shapes in this playback

Fixed – no effect

Fader –size of all types of shape set by fader position

HTP fader – only dimmer shapes are controlled by fader position

Shape & effect speed: sets whether the fader position affects the speed of shapes in this playback

Curve: Allows you to set a different curve shape for this playback – curves are listed on the softkeys. The various curves are illustrated in section 13.7 on page 251.

You can also allocate a Speed Master to the cue which will allow you to modify the shape during playback, see section 7.2.4 on page 153.

7.6.4 Playback options - Effects

Shape behaviour: same as in playback tab, see above

Speed source: Allows you to allocate a Speed Master to this playback. See section 7.2.4 on page 153.

Size source: Allows you to allocate a Size Master to this playback

Shape size: same as in fader tab, see above

Shape & effect speed: same as in fader tab, see above



If you have a cue which contains only shapes to overlay on other cues, set the cue to [Size on Fader] and allocate a Speed Master. You can then create lots of different looks out of the shape by varying the size and speed at show time using the playback fader and the speed master.

7.6.5 Playback options - Release

Release Mask: lets you specify which attributes will be released to the state they were in from a previously fired playback when this playback is killed (you lower the fader to zero). You can also use the Attribute Bank buttons to set the mask.

The mask can be set to Global or Local. Local means you can make individual mask settings for this playback. Global uses the global release mask which is set in the Release menu (press Release).



Release mask is useful when creating a temporary strobe effect on a playback. Press [Release Mask] then the Intensity/Shutter attribute button. Now when you turn off the playback the shutter will release to its previous state and the strobe will stop.

When using with chases you need to press [Mask] before pressing the Intensity/Shutter button.

You can use Key Profiles to allocate one of the handle buttons to release the playback.

Release Time: Sets a release fade time for this playback. Enter blank time to return to global (Global release time is set in the User Settings).

8. Chases

As well as being used to store static cues, the playback faders can also be used to store chases (sequences of cues). You can also store chases on touch buttons in the Playbacks window.

Chases can run once or repeat continuously. You can set individual fade time for each cue in the chase and unlink cues so that the console waits for you to press Go before the chase continues.

8.1 Creating a chase

8.1.1 Programming a chase

To program a chase, you have to set up the look for each cue in the chase, then save it.

You can either set all the fixtures and dimmers manually for each cue in the chase, you can use Quick Build to create a state from palettes and cues, or you can use Include to load in cues.

-
- 1> *Press the Record button, then select [Chase] .*
 - 2> *Press the Swop button of the playback where you want to store the chase (you can also store chases on touch buttons in the Playbacks window).*
 - 3> *Set up the look for the first cue, either manually or by using "Include" on existing cues.*
 - 4> *You can change the number given to the step using [Step Number].*
 - 5> *Press the Swop button of the playback to store the programmer contents as a step of the chase. You can also press [Append Step] on the menu.*
 - 6> *Press Clear (unless you want to re-use the contents of the programmer), then repeat from step 3.*
 - 7> *Press Exit to finish when you have stored all the cues you want.*
-

- [Record Mode] lets you select Record By Fixture (all attributes of any modified or selected fixture are saved), Record By Channel (only modified attributes are saved), Record Stage (all fixtures with a non-zero dimmer setting are saved), or Quick Build (see next section).
- The cue number currently being saved, and the total number of cues, is shown on the top line of the display.
- Press Clear when you have finished recording the chase, otherwise when you try to play it back the programmer will override the chase and you won't see the chase properly.
- You can record shapes in a chase. If the same shape is saved in subsequent cues it will continue from step to step and if not it will stop at the end of the cue. (The shape is the same if you didn't press Clear after the previous step, and didn't change the speed, size or phase of the shape from the previous step; or if you Included the shape from the previous step and have not modified it)

- You can set a legend for the chase by pressing Set Legend, then pressing the Swop button for the chase and entering the legend, as with cues.
- There is no limit to the number of steps in a chase.

8.1.2 Creating a chase with Quick Build

Quick Build mode, as the name suggests, allows you to build a chase very quickly from existing palettes and playbacks.

Start recording a chase as described in the previous section, set [Record Mode] to Quick Build.

Select any palette or playback to insert that item as a step in the chase. If you select multiple palettes by selecting a range of buttons, each palette will be added as a separate step.

To insert specific fixtures from a palette or playback, select the fixtures first and then select the palette or playback.

8.2 Playback

8.2.1 Playing back a chase

To fire a chase, raise the fader of the playback. (You can also use the Flash/Swop buttons). The chase will start to run. The bottom line of the screen relating to the playback fader shows the current cue number and speed of the chase.

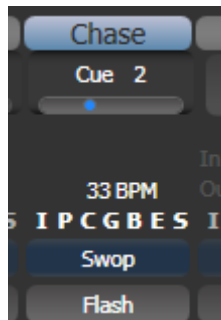

- The HTP (intensity) channels in the chase will be controlled by the fader; if fade times are programmed, the fade will stop at the fader level. The other channels (LTP) will be set as soon as the fader moves above zero according to the fade times programmed in the chase. You can set the point at which the LTP channels activate from the User settings menu.
- While the chase is running, the area of the screen above the wheels shows details of the chase steps.

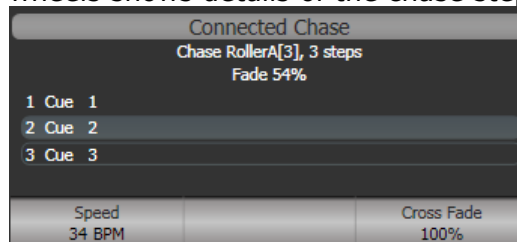

- You can temporarily pause the chase by pressing the Stop button near the wheels. Press Go to resume playback.

There are many options you can set to determine the way the chase runs and these are described in the rest of this chapter.

8.2.2 Connecting a chase for control

When you fire a chase, the wheels and Stop/Go buttons are automatically allocated to control the speed and crossfade of the chase – this is called Connecting the chase. If you have more than one chase running, you can choose which chase is connected to the controls using the Connect button.

- Connect a different chase to the controls by pressing the Connect button then the Swop button of the chase you want to control.
- Disconnect a chase from the controls by double pressing the Connect button.
- You can turn off the “chase autoconnect” option in the User Settings menu if you don’t want to connect to a chase when you fire it. You will have to use the Connect button to control the chase if you do this.
- Normally if you change the speed or crossfade of a chase, the new setting is saved. However you can set this change to be temporary, so that when the show is reloaded the speed and fade will go back to the previously saved settings. Go to User Settings (Avo button + [User Settings]) and set option C to [Connected View Sets Temporary Chase Speed]. You can still save a temporary speed by pressing [Save Temporary Speed] in the Set Times menu.

8.2.3 Setting speed and crossfade for a chase

The left wheel is assigned to control the speed of the chase it is connected to. The speed is shown in Beats Per Minute (BPM) on the display. You can also enter a speed from the keypad as described below. The last speed you set on the wheel is always remembered, you do not have to tell the Quartz to save it.

Crossfade is the “slope” between cues; with a crossfade of 0, the fixtures snap instantly to the next cue, but with a crossfade of 100, the fixtures spend the whole cue time fading to the next cue. With a crossfade of 50, the fixtures delay for half the cue time and fade for the other half of the time.

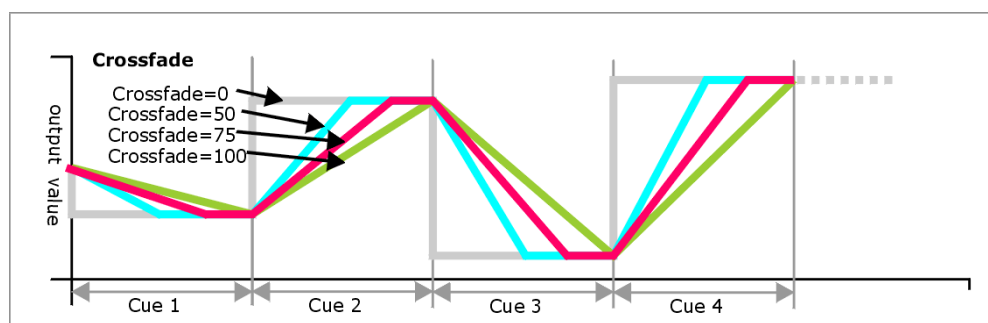

You set the crossfade and speed as follows:

- 1 > Press [Edit Times] from the top level menu then the Swop button of the chase.

- 2> *To set the crossfade, press [Xfade] and type the fade from 0 – 100. 0=no fade (the chase will “snap”), 100=max fade (the chase will move continuously from step to step).*
 - 3> *To set the speed, press [Speed], type the new speed, then press Enter. The speed can be set in Beats Per Minute (BPM) or seconds depending on the User Settings.*
-

There are other options you can set for the chase from this menu including Fixture Overlap, which are described in the Timings section 8.5.1 on page 176.

You can set individual times for each cue in a chase and unlink cues from each other so they wait for you to press the Go button. This is done using the Playback View, or the Unfold function which is described in section 8.3.2 on page 175.

You can select whether the chase speed is displayed in seconds or in Beats Per Minute (BPM). Press Avo and [User Settings], then press [Tempo Units] to set the option to [Tempo Units Seconds] or [Tempo Units Beats Per Minute (BPM)].

You can also allocate a Speed Master to the chase which will allow you to modify the chase speed during playback, see section 7.2.4 on page 153.

8.2.4 Manually controlling the steps of a chase

You can pause a chase, if the chase is connected to the wheels, by pressing the Stop button next to the wheels. Press the red Go button to resume playback of the chase.

While the chase is stopped you can use the Prev Step/Next Step buttons next to the Connect button to move to the next or previous step. The programmed fade time will be used when moving between steps, unless you enable the user setting [Chase Snap], or press the Snap button if the console has one.

You can also configure the blue and grey buttons of the playback handle to be Stop and Go. This uses the Key Profiles function.

-
- 1> *Hold Avo and press [Edit Current Key Profile].*
 - 2> *If you are using the default Key Profile which is not editable, you will be prompted to add a new profile.*
 - 3> *Press [Chases] then choose either the Blue key or the Grey key.*
 - 4> *Select Go or Stop from the list of functions. Then press Exit and set the function for the other key if required.*
 - 5> *Press Exit to continue using the console.*
-

8.2.5 Changing chase direction

The Prev Step/Next Step buttons next to the Connect button set the direction of the connected chase.

8.2.6 Jumping to a step

You can jump directly to a step in a chase by pressing the Connect button, then typing in the desired step number, then pressing Enter or softkey A. Alternatively at the top level menu you can type the step number then press Connect.

8.3 Editing a chase

8.3.1 Opening a chase for editing

You can open a chase for editing by pressing Chase then the Swop button of the chase. This does not affect any existing cues in the chase. You can then save new cues at the end by pressing the Swop button just like normal recording.

To see a list of the cues in the chase, use Playback view (touch the playback display above the fader or press Window Open then the Swop button of the playback). To edit any of the time settings in each cue, select the setting to be modified by touching or dragging in the grid, then use the softkey options to change the setting.

Playback View - Chase 'PRESS GO'							
	Legend	Delay In	Fade In	Fade Out	Fixture Overlap	Link	View Cue
1	Cue 1	Global	Global	= As In	Global	After Previous	View
2	Cue 2	Global	Global	= As In	Global	After Previous	View
3	Cue 3	Global	Global	= As In	Global	After Previous	View
5	Cue 5	Global	Global	= As In	Global	After Previous	View
6	Cue 6	Global	Global	= As In	Global	After Previous	View
7	Cue 7	Global	Global	= As In	Global	After Previous	View
8	Cue 8	Global	Global	= As In	Global	After Previous	View

8.3.2 Editing a chase using Unfold

Unfold provides another way to edit chases. The Unfold button places each cue in a chase on one of the playback faders, allowing you to fire and edit each cue individually as if it was a stand-alone cue. Unfold also allows you to set individual timing for cues in the chase.

-
- 1> Press the Unfold button, then the Swop button of the chase to be edited.
 - 2> The first 10 cues of the chase are loaded into the playback faders.
 - 3> Raise a playback fader to output the contents of that cue (fade times will operate as programmed).
 - 4> Various Unfold options are available, the details are below.
 - 5> Press Unfold again to get out of unfold mode.
-

- To edit the contents of a cue: Press Clear to empty the programmer, raise the fader to output the cue, make the changes, press [Record Step], then the Swop button for the cue number.
- To Insert a new cue at the end of the chase, set up the look for the new cue, press [Insert Step], then press the swop button of the first free playback.

- To merge the programmer into the live step, double tap [Record Step].
- To Insert a cue between two other cues, set up the look for the new cue, press [Insert Step], then type the cue number for the new cue (such as 1.5 to go between 1 and 2). If this cue number already exists it will be merged with the look you have created. Otherwise a new cue is inserted.
- To change individual times for the cue, press [Edit Times], then the Swop button for the cue (or type the cue number), then set the times. This is described in detail in the Timing section on the following page.
- If the chase has more steps than there are playback faders, you can go between pages using the [Previous Page] and [Next Page] buttons.

8.4 Copying, moving, linking and deleting

8.4.1 Copying or moving a chase

Chases can be copied or moved to a new playback, or you can create a linked copy of a playback. Move is useful for tidying up the console. Linked chases are handy if you want a chase to appear on more than one page for ease of operation; the linked chase can have different timings and playback options.

This operation is exactly the same as for Cues and is described in detail in section 7.4.1 on page 161.

8.4.2 Deleting a chase

You can delete an entire chase by pressing the Delete button followed by the Swop button of the chase to delete. Press once more to confirm.

8.4.3 Deleting a step from a chase

To delete a single step from a chase:

-
- 1> *Press the Delete button.*
 - 2> *Press the Swop button of the chase.*
 - 3> *The steps in the chase are listed on the screen. Use the left hand wheel to select the step you want to delete, or type in the number of the step to be deleted.*
 - 4> *Press [Delete Cue x] to delete the step.*
 - 5> *Press [Confirm] to confirm the delete.*
-

- Alternatively you can use the Unfold function to delete a step from a chase.

8.5 Chase timing

8.5.1 Global timings for chases

When a chase is first programmed, each cue in the chase has identical timing. This is called the global timing for the chase. If you want you can then set each cue to have its own timings using the Playback View window or Unfold. This is described in the next section.

- 1> Press [Edit Times] from the top level menu then the Swop button of the chase.
- 2> Set the Crossfade, Speed, Fixture Overlap and Attribute Overlap settings as described below.
- 3> Press Exit to finish.

- To set speed, press [Speed] then type the new speed, then press Enter. The speed can be set in Beats Per Minute (BPM) or seconds depending on the user settings.
- To set crossfade, press [Xfade] then type the fade from 0 – 100 and press Enter. 0=no fade (the chase will “snap”), 100=max fade (the chase will move continuously from cue to cue).
- When in Run mode, you can set the chase speed of the connected chase by tapping the [Tap Tempo] button in the main menu at the speed you want the chase to run. (The option only appears when a chase is connected). You can also assign the blue or grey handle button to be a “tap tempo” button using the Key Profiles option (see section 13.4.1 on page 242).

The Overlap functions allow you to offset and overlap the timing of changes in the chase. This can create really amazing visual effects with hardly any programming. The best way to learn about overlap is to program a chase with two cues involving several fixtures, then experiment with the overlap settings to see the various “roll” and “peel off” effects which result.

The following diagram shows you the effects of cue overlap, fixture overlap and attribute overlap in chases.

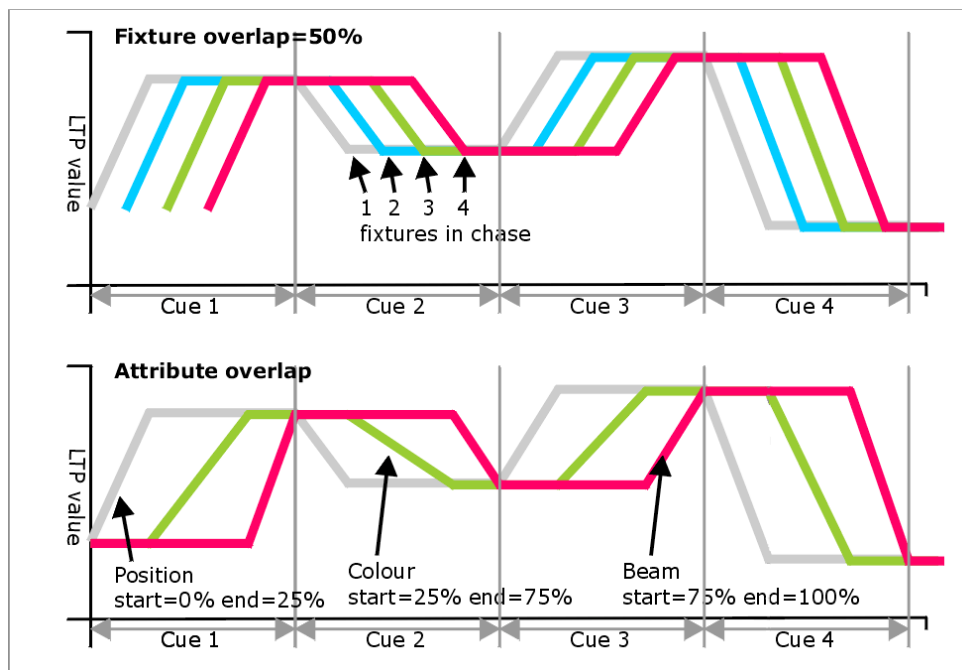

- Press [Fixture Overlap] then enter 0-100 on the keypad to change how fixtures overlap in the cue. 100% (the normal setting) means all fixtures fade together. 0% means that the first fixture will finish its fade before the next one starts giving a “rolling” change across a range of fixtures. 50% means that the 2nd fixture will start fading when the first one is half way

through its fade. The order of the fixtures is set by the order you selected them when the cue was saved; you can change the order using Unfold.



From version 3 of Titan software, [Cue Overlap] is no longer available in chases. Instead use a Cue List set to "Link With Previous" and set the Offset as desired.

8.5.2 Individual cue times in chases

You can configure each cue in a chase to have its own timing information. You can use the Playback View window, or the Unfold function to set individual times for cues in chases.



It is easier to use a Cue List rather than a chase if you need a lot of different timings or link/unlinks. Cue lists are described in the next chapter.

Using the Playback View window:

- 1> *Touch the playback display relating to the fader, or press Window Open then the swop button of the playback. The Playback View window will open.*

Playback View - Chase 'PRESS GO'							
	Legend	Delay In	Fade In	Fade Out	Fixture Overlap	Link	View Cue
1	Cue 1	Global	Global	= As In	Global	After Previous	View
2	Cue 2	Global	Global	= As In	Global	After Previous	View
3	Cue 3	Global	Global	= As In	Global	After Previous	View
5	Cue 5	Global	Global	= As In	Global	After Previous	View
6	Cue 6	Global	Global	= As In	Global	After Previous	View
7	Cue 7	Global	Global	= As In	Global	After Previous	View
8	Cue 8	Global	Global	= As In	Global	After Previous	View

- 2> *In the grid, touch the times you want to edit.*
 - 3> *Use the softkey options to change the times or settings.*
 - 4> *Repeat from 2 to change other times or settings.*
- You can change a range of cues all at once by dragging across the grid to select multiple cells, or you can use wheel B to select multiple cells for editing.

Using Unfold:

- 1> *Press the Unfold button, then the Swop button of the chase to be edited.*
- 2> *Press [Edit Times] then the Swop button of the unfolded cue you want to edit.*
- 3> *Set up the timing options as required. The options are described below.*
- 4> *Press Unfold to get out of unfold mode.*

Initially all the timing options are set to Global. You can cancel any individual timings and set the time back to global timings by pressing the softkey for the option then pressing [Use Global].

The timing options for the cue are:

- Delay
- Fade (in)
- Fade Out
- Fixture Overlap
- Link with previous step
- Attribute times (see next section)

Linking can be set to [Link After Previous] (the chase will run automatically) or [Link Wait For Go] which will stop the chase until you press Go.

8.5.3 Setting attribute fade times for a cue in a chase

For each cue in a chase, you can set individual fade times for each attribute group (such as position). If you set a time, it overrides the normal times. You can use the Cue View window, or the Unfold function to set attribute times.

To set an attribute group fade time:

-
- 1> Press Window Open or the Unfold button, then the Swop button of the chase to be edited.
 - 2> Press [Edit Times] then touch the cue you want to edit in the Playback View, or if using Unfold, press the Swop button of the unfolded cue you want to edit.
 - 3> Press the Attribute Options button (right hand side) for the attribute you want to change.
 - 4> Press [Delay] to set delay time or [Set fade] to set fade time.
 - 5> Type the new time using the numeric keypad and press Enter to save it, or press [Use Global] to delete the attribute times and go back to the normal times.
 - 6> Press Enter to save the changes.
-

8.6 Chase options

To set options for a chase, press [Playback Options] on the root menu, then press the Select button of the playback to be edited. To view the options window, press View then the Select button of the playback, then click the Options tab.

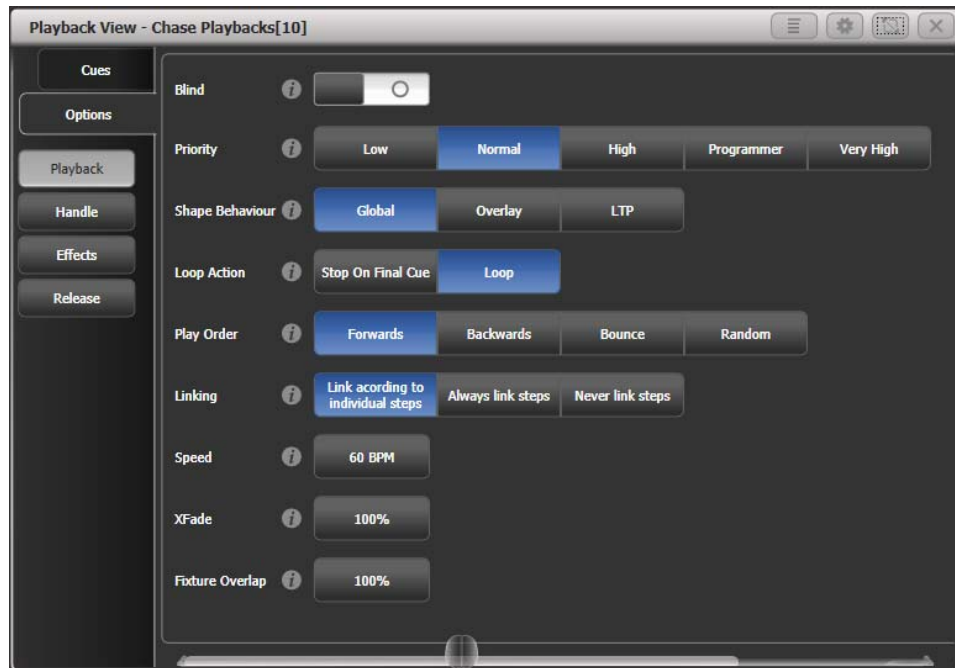

Most of the options are the same as for Cues (see section □ on page 166), only the additional Chase options are described here.

8.6.1 Chase options - Playback

Blind, Priority, Shape Behaviour are described in the Cues chapter.

Loop Action: Sets what happens at the end of the chase.

[Stop on Final Cue] – chase stops at the end

[Loop] - the chase will loop back to the beginning

Play Order: sets the direction of the chase.

Linking: Sets how the cues in the chase are linked. The options are:

[Link according to individual steps] - Each step in the chase will obey its individual link settings which are set using the Playback View window or the Unfold function.

[Always Link Steps] - The chase will run on its own using the times

[Never Link Steps] - The chase will pause after every delay/fade time for the user to press Go.



When a chase is unlinked, raising the fader does not fire the first cue, which can be a problem. To get round this, if the chase is not looped, simply link the first cue to the previous one. If the chase is looped, add a dummy step at the end with 0 sec fade, 0 sec delay and link the first step to this one.

Speed: Provides another way of setting chase speed.

XFade: Provides another way of setting chase crossfade.

Fixture Overlap: Allows you to set the fixture overlap for the chase.

8.6.2 Chase options – Handle

All options in this section are described in the cues chapter.

8.6.3 Chase Options – Effects

All options in this section are described in the cues chapter.

8.6.4 Chase Options - Release

Release Mask and Release Time are described in the cues chapter.

Cue Release: allows you to create an overlay chase with gaps in it where the fixtures will return to their previous state. For example you could create a chase where every alternate cue sets the fixtures to white, with the in between cues being blank. If this option is on, the fixtures will bump to white then return to the colour set from a previous look.

8.6.5 Renumber All Cues

This option is only available on the softkeys, not the option screen. This will renumber all the cues in the chase starting from 1.

9. Cue Lists

Cue Lists (sometimes known as stacks or cue stacks) allow you to record a sequence of cues, each of which can have its own timings and can be triggered by the Go button or run automatically to the next cue. This allows you to build a complete show in a single list and is ideal for theatrical shows where the show must be exactly the same each time. Cue lists can also be useful in busked shows, especially on consoles with a small number of playback faders, to offer a number of different looks on one fader.

Cue lists differ from chases in the way the console handles changes between cues. Cue lists track fixture state from previous cues and will only change the fixture state if you have modified that fixture in the cue; if there are no changes stored for the fixture, it will remain in the same state. Chases on the other hand would crossfade between cues, fading out all fixtures which have no stored information in the new cue.

You can change the tracking behaviour of cue lists using the tracking option for each cue: Block, This Cue Only and Solo (see section Tracking on page 189).

To view the contents of a cue list, touch the playback screen relating to the fader or press Window Open then the swop button of the playback.

Playback View - Cue List Playbacks[7]												
	Legend	Delay In	Fade In	Delay Out	Fade Out	Fixture Overlap	Link	Link Offset	Preload	Curve	Autoload	Tim
1	Tabwarm	0	2	= As In	= As In	100%	Wait For Go	Disabled	<input type="checkbox"/>	Linear	Load Cue RollerB[3];	23:5
2	Cue 1	0	2	= As In	= As In	100%	Wait For Go	Disabled	<input type="checkbox"/>	Linear		23:5
3	End of scene	0	2	= As In	= As In	100%	Wait For Go	Disabled	<input type="checkbox"/>	Linear		23:5
4	Cue 2	0	2	= As In	= As In	100%	Wait For Go	Disabled	<input type="checkbox"/>	Linear		23:5
5	Cue 5	0	2	= As In	= As In	100%	Wait For Go	Disabled	<input type="checkbox"/>	Linear		23:5
6	Cue 6	0	2	= As In	= As In	100%	Wait For Go	Disabled	<input type="checkbox"/>	Linear		23:5

9.1 Creating a cue list

9.1.1 Programming a cue list

Programming a cue list is similar to recording a chase.

You need to set up the look on the stage for each cue and then add it to the cue list. If you want to set fade times, you can either set them while saving the cues or later.

- 1> Press Record then [Create Cue List].
- 2> Press the blue Select button of the playback where you want to store the Cue List (you can also store cue lists in the Playbacks window).

- 3> *Select the Record Mode of the console: by Fixture, Channel, Stage or Quick Build; if you are using tracking, [Record Mode Channel] is best as you are sure to only record the attributes you have explicitly set, but you do need to make sure you have changed all the things you want to be recorded so they are in the programmer.*
- 4> *Set the default Fade and Delay times, and automatic cue linking, using [Set Times]. These settings will be allocated to every new cue.*
- 5> *Set up the look for the first cue, either manually or by using "Include" on existing cues. You can use the Shape Generator and the Pixel Mapper.*
- 6> *If you require a legend for the cue, set it now using [Legend]. You can also change this later using Unfold or Set Legend (see next section).*
- 7> *Press the Select button of the handle or [Append Cue] to store the programmer contents as Cue 1 of the cue list.*
- 8> *Repeat from step 5 for the next cue. Do not press Clear in between cues, unless you want levels to track through from previous cues, as any faders moving to zero will not be stored. If you do press clear, you must make sure that all channels you want to record are selected or in the programmer (inverted display).*
- 9> *Press Exit to finish when you have stored all the cues you want.*

- [Record Mode] lets you select Record By Fixture (all attributes of any modified or selected fixture are saved), Record By Channel (only modified attributes are saved), Record Stage (all fixtures with a non-zero dimmer channel are saved) or Quick Build (allows you to build a cue from other playbacks or palettes; select the playbacks/palettes you wish to use and press [OK]).
- Record By Channel is useful if you want to layer this cue list with other playbacks to create an effect.
- You can reopen the cue list to add more cues by repeating the procedure above; this does not affect any cues already stored in the cue list.
- To add more cues to the end of the existing cues press [Append cue].
- To edit an existing cue, press [Cue Number=] and type the cue number to edit. Make the changes then press [Update Cue x].
- To insert new cues, see section 9.3.5.
- The Advanced Options menu allows you to renumber all the cues, and to change the number of an existing cue.
- There is no limit to the number of cues in a cue list.
- Cue lists offer a Move In Dark function which will move fixtures to the correct position for their next cue while they are set to zero intensity. See section Move In Dark (MID) functions on page 190.

- You can change the tracking mode of each cue. See section 9.2.3 on page 189.

9.1.2 Changing legends for cues in a cue list

You can set a legend for each cue, which is shown on the screen when running the cue list and can be helpful for keeping track of where you are.

-
- 1> Press [Set Legend] in the top level menu. If you are setting legends for several cues, press Menu Latch to latch the Set Legend menu.
 - 2> Press the Select button of the Cue List.
 - 3> The cues in the cue list are shown on the screen. Touch the list or use Wheel A to select the cue which is to have a legend set.
 - 5> Press [Cue Legend] and type the legend on the keyboard, then press Enter.
 - 6> If you latched the menu, you can continue to set legends for other cues, or press Exit to finish.
-

9.1.3 Shape tracking in cue lists

Shapes can track between cues in cue lists. If shape tracking is enabled, a shape started in a cue will continue through following cues. Shape tracking is enabled using the [Shape Tracking] option in the Playback Options for the cue list – see section 9.6.4.

Cues containing shapes have a button for each shape.

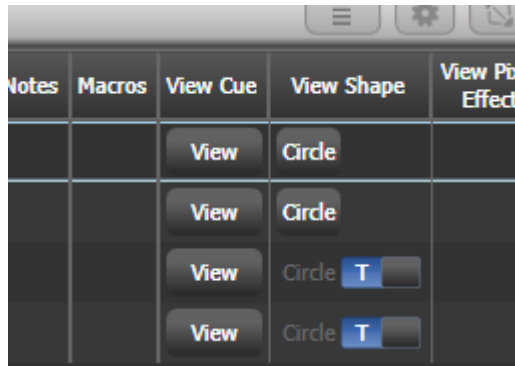

In the following cues where shapes are tracking, an option switch is shown for each active shape.

T – Allows the shape to track to the next cue

B – Blocks the shape so it will not appear in following cues

The cue itself can also have options set to block all shapes, see section 9.6.7.

You can also block attributes for shapes independently during recording using the @ menu. Select the Attribute using the attribute bank buttons, press @ then the FX group button. The softkeys will then give the options [Block Shape] and [Unblock Shape]. If an attribute is set to Blocked the wheel display will show a "Blocked" watermark.

If Shape Tracking is not enabled, shapes in each cue are independent from each other. If an identical shape (with the same size and speed)

is saved in a following cue then the shape will continue running rather than restarting.

9.1.4 Autoloading a playback within a cue list

You can program a cue within a cue list to automatically load one or more playbacks when the cue fires. The playback can be a single cue, a chase or another cue list. This can be a useful way to trigger chases or effects from the cue list.

You can either automatically save active playbacks as Autoloads, or you can manually allocate Autoloads to cues.

To automatically record active playbacks as Autoloads:

- 1> *After selecting Cue List Record, turn on [Autoload Live Playbacks] in the [Advanced Options] menu of the cuelist record screen.*
- 2> *Turn on the playbacks you wish to load for this cue.*
- 3> *Save the cue. Active playbacks will be saved as Autoloads.*

To manually edit autoloads use the playback view for the cue list:

- 1> *Press View*
- 2> *Press the blue Select button of the Cue List.*
- 3> *The cues in the cue list are shown on the screen. Click on the Autoload you wish to change. (You will need to set the window to full screen size or scroll across to see the Autoload column. If the Autoload column is not show, click on the Show All button on the left of the window.)*
- 4> *Press the Select button of the playback which is to be loaded. The playback legend appears on the softkeys.*
- 5> *You can continue to add Autoloads to other cues, or press Exit to finish.*

Playback View - Cue List Playbacks[7]												
	Legend	Delay In	Fade In	Delay Out	Fade Out	Fixture Overlap	Link	Link Offset	Preload	Curve	Autoload	Tim
1	Tabwarm	0	2	= As In	= As In	100%	Wait For Go	Disabled	<input type="checkbox"/>	Linear	Load Cue RollerB[3];	23:5
2	Cue 1	0	2	= As In	= As In	100%	Wait For Go	Disabled	<input type="checkbox"/>	Linear		23:5
3	End of scene	0	2	= As In	= As In	100%	Wait For Go	Disabled	<input type="checkbox"/>	Linear		23:5
4	Cue 2	0	2	= As In	= As In	100%	Wait For Go	Disabled	<input type="checkbox"/>	Linear		23:5
5	Cue 5	0	2	= As In	= As In	100%	Wait For Go	Disabled	<input type="checkbox"/>	Linear		23:5
6	Cue 6	0	2	= As In	= As In	100%	Wait For Go	Disabled	<input type="checkbox"/>	Linear		23:5

The Autoloaded playback will be fired when the cue starts, and killed when the cue list moves on to the next cue, unless you have also loaded the playback into the next cue.

You can set options for each Autoloaded playback by pressing the softkey where the Autoloaded playback is shown.

For a cue, the only option is [Remove this Autoload].

For a chase or cue list, softkey B lets you select whether to load the playback from the start, to start at a specific cue, or to press Go on the target playback.

In the Autoload Times column you can set fade in, fade out and delay times for the autoloading playback. Normally the autoloading will use the times set for the cue, but you can also select [Use Individual Target Times] which will use the times set in the autoloading playback, or you can set independent times yourself.

9.1.5 Running a key macro from a cue list

You can program a cue within a cue list to trigger a key macro. This allows you to set up custom actions which can be performed when a cue in a cue list fires; for example you may want to lamp on your fixtures as the first cue in the cue list.

-
- 1> Press [Playback Options].
 - 2> Select the cue list.
 - 3> Select [Macros].
 - 4> In the Playback View window, select the step you want to add a macro to.
 - 5> Press the button(s) for the macro(s) you want to attach to the step. Or press [Add] and choose an action from the list.
-
- 3> The "Macros" column shows the macros you have added.
-

- You can remove macros by selecting the cue, pressing the softkey for the macro you wish to remove and then pressing [Remove Link].

9.1.6 Keyboard shortcuts/syntax for cue lists

The following keyboard syntax can be used for fast cue list recording and editing. These commands work for the selected or currently connected playback where <n> is the cue number.

Record , Connect, <n>, Enter (Record cue n)

- Copy, Connect, <n> (Copy cue n)
- Delete, Connect, <n> (Delete cue n)
- Include, Connect, <n> (Include cue n)
- Connect, <n>, Go. (Go cue n)

9.2 Cue List playback

9.2.1 Running a cue list

Raise the fader of the cue list and press the Go button to run the first cue. The bottom section of the display shows the cue list; the current cue is highlighted in grey and the next cue has a box round it.

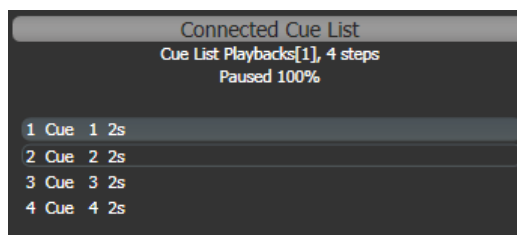

Also the display relating to the playback fader shows information about the cue list, including the current and next cue, fade progress of the current cue, and fade in/out times.

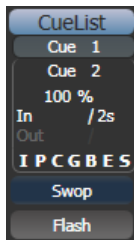

You can also open the Playback View window to show more details of the cue list by clicking the Cue List legend area or press Window Open then the swop button of the playback. This shows all the timings, links and tracking status and is very useful when running a theatre show on a cuelist.

Playback View - Cue List 'Master Cue List'

Cues	Legend	Delay In	Fade In	Delay Out	Fade Out	Fixture Overlap	
Options	1	Cue 1	0	3	As In	As In	100 After
Show All	2	Cue 2	0	3	As In	As In	100 After
Times	3	Cue 3	0	3	As In	As In	100 After
Filter	4	Cue 4	0	3	As In	As In	100 After

When times are in progress on a cue, green progress bars are shown in the Playback View window.

The Playback View will autoscroll to keep the active cue onscreen. You can change the way the autoscroll works using the view options (click the options/cog icon at the top of the window).

- The HTP levels of cues in the cue list are mastered by the fader level.
- You can pause a fade by pressing the Stop button above the Go button. Press Go again to resume the fade.
- You can skip to any cue in the cue list by selecting a "next" cue using Wheel A, or using the left/right arrow keys. When you press Go, the cue list will run that cue next.
- You can snap back to the previous cue by pressing the Snap Back button (not on all consoles)
- On consoles with a Snap button (Arena and Tiger Touch 2), the Prev Step/Next Step buttons will go to the previous/next cue using the programmed times. If you turn on the Snap button, the Prev/Next buttons will snap immediately to the cue. There is also a User Setting [Chase Snap] which enables this mode on consoles which don't have the button.

- You can jump directly to a cue by pressing the Connect button, then typing in the desired cue number, then pressing Enter or softkey A. Alternatively at the top level menu you can type the cue number then press Connect.
- You can use Key Profiles to set the blue and grey buttons of the playback to have various functions including Go, Stop, Connect, Next Cue, Prev Cue, Cut Next Cue To Live, and Snap Back.
- When you lower the fader for a cue list, the HTP channels will fade out, but the cue list will remain active. The section below details how to kill the cue list.
- You can use timecode to play back a cue list automatically. See section 9.5.5 on page 199.
- You can change the time for the next cue by entering the time on the keypad then pressing Go. You can jump to another cue and set a different time by typing the cue number then press Connect, then type the time and press Go.

9.2.2 Killing a cue list

Once a cue list is fired, it remains active until you kill it. You do this by holding down the Avo Shift button and pressing the blue Select button of the cue list's handle.

You can change this in the Playback Options to make the cue list automatically clear when the fader reaches zero (press [Playback Options] at the program menu, then press the Select button of the cue list, then select [Fader] [Fader Mode Intensity Kill At 0]).

You can also use Key Profiles to configure one of the handle buttons to release the cue list.



While the cue list remains active, any shapes/effects stored in the current cue will run even if the fader is at zero. If you are working with a cue list and have unexplained shapes occurring, check all cue lists have been killed.

9.2.3 Tracking

By default, cue lists run in tracking mode. Only changes in attributes are stored, everything else just continues at the level it was previously set to. Tracking mode is usually used for theatrical performances because it means that if you need to adjust a dimmer level at the start of a scene, you don't have to go through and change the level on every cue for that scene, the change just tracks through the other cues until a new level is stored.

You can enable or disable Tracking mode globally for the whole cue list, or each cue can have Tracking mode set individually from the Playback View window (or Playback Options, [Cue Options]).

Settings are:

- [Global] (default): obeys the global setting for the cue list.
- [Track]: the cue will track
- [Block]: the cue will not take tracking states from previous cues. All subsequent cues will track from the Block cue.

- [Solo Excluding Shapes]: No states are tracked into or out of the cue, but shapes will track into the cue, except for dimmer shapes which will not track. This lets you have a cue that solos all levels but allows non-dimmer shapes to continue.
- [Cue Only]: changes in this cue will not track to subsequent cues. Unchanged states from previous cues will be restored in subsequent cues.
- [Solo]: No states are tracked into or out of a solo cue. States from previous cues will track to subsequent cues but will not appear in the solo cue.
- [Block Shapes]: Any tracked shapes will stop from this cue. Other attributes will continue to be tracked. This lets you create a point where you can guarantee all shapes will stop.

9.2.4 Move In Dark (MID) functions

When using moving lights in theatre, often you would like them to be positioned ready for the next cue so that you do not see them moving. The Move In Dark function does this by automatically positioning the fixture for the next cue when it is not lit.

Move In Dark options can be set either for the whole cue list or for individual cues.

Options for the whole cue list are set by pressing [Playback Options] then the select button for the cue list, then [Playback].

- [Disabled] prevents Move In Dark functions for all cues in the cue list regardless of the individual cue settings.
- [Early] will attempt to position a fixture as soon as possible unless overridden in an individual cue.
- [Late] will position the fixture as late as possible.
- [Off] turns off Move In Dark unless enabled in individual cues (default).

For individual cues the options are set using the Playback Window.

- [Global] uses the cue list's global setting (default)
- [Cue Number] specifies a cue where you would like the move to occur
- [Cue Offset] specifies a preferred number of cues in advance
- [Disabled] prevents Move In Dark for this cue
- [Early] will move as early as possible
- [Late] will move as late as possible.

Move In Dark delay and Move In Dark fade times can be set for the whole cue list or for each cue using the Set Times menu. Each cue also has a Move In Dark Inhibit option which prevents any movements during that cue (useful if you need to prevent fixture noise).

If the fixture has its intensity above zero or Move In Dark is inhibited when the Move In Dark is supposed to occur, the console will attempt the movement in the nearest suitable cue instead.

9.3 Editing cue lists

9.3.1 Playback View window

The easiest way to edit a cue list is using the Playback View window (press Window Open then the select button for the cue list to open it). This shows a grid with each cue and allows you to change most features of the cue. Click on the item you want to change in the grid, and the softkeys will offer you the different options.

To change multiple cues at once, draw a box across the items you want to change.

The Intensity View window is useful for seeing the state of all fixtures, see section 4.2.2 on page 90.

9.3.2 Editing values in Cue View window

You can edit the value of every fixture in each cue using the Cue View window. Press the View Cue button at the right hand end of the Playback View window.

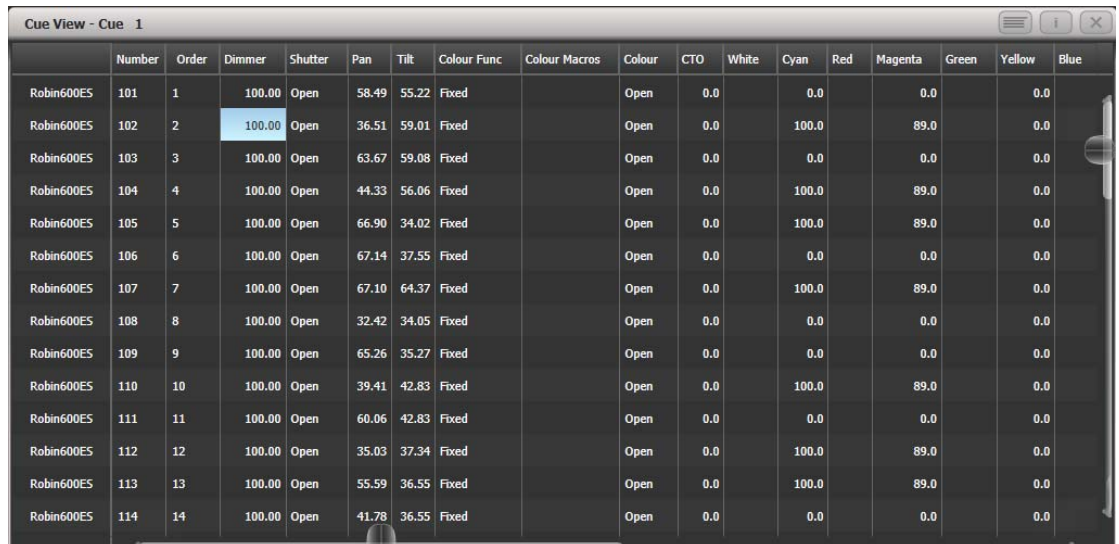

	Number	Order	Dimmer	Shutter	Pan	Tilt	Colour Func	Colour Macros	Colour	CTO	White	Cyan	Red	Magenta	Green	Yellow	Blue
Robin600ES	101	1	100.00	Open	58.49	55.22	Fixed		Open	0.0		0.0		0.0		0.0	
Robin600ES	102	2	100.00	Open	36.51	59.01	Fixed		Open	0.0		100.0		89.0		0.0	
Robin600ES	103	3	100.00	Open	63.67	59.08	Fixed		Open	0.0		0.0		0.0		0.0	
Robin600ES	104	4	100.00	Open	44.33	56.06	Fixed		Open	0.0		100.0		89.0		0.0	
Robin600ES	105	5	100.00	Open	66.90	34.02	Fixed		Open	0.0		100.0		89.0		0.0	
Robin600ES	106	6	100.00	Open	67.14	37.55	Fixed		Open	0.0		0.0		0.0		0.0	
Robin600ES	107	7	100.00	Open	67.10	64.37	Fixed		Open	0.0		100.0		89.0		0.0	
Robin600ES	108	8	100.00	Open	32.42	34.05	Fixed		Open	0.0		0.0		0.0		0.0	
Robin600ES	109	9	100.00	Open	65.26	35.27	Fixed		Open	0.0		0.0		0.0		0.0	
Robin600ES	110	10	100.00	Open	39.41	42.83	Fixed		Open	0.0		100.0		89.0		0.0	
Robin600ES	111	11	100.00	Open	60.06	42.83	Fixed		Open	0.0		0.0		0.0		0.0	
Robin600ES	112	12	100.00	Open	35.03	37.34	Fixed		Open	0.0		100.0		89.0		0.0	
Robin600ES	113	13	100.00	Open	55.59	36.55	Fixed		Open	0.0		100.0		89.0		0.0	
Robin600ES	114	14	100.00	Open	41.78	36.55	Fixed		Open	0.0		0.0		0.0		0.0	

You can then click on the values you want to change and edit them using the softkeys.

- The context menu buttons allow you to view levels, shapes, effects and times for each attribute of each fixture in each cue.
- If levels are set from a palette, the View Palettes button either shows you the palette used, or the underlying value.
- If the View Tracking Values button is selected, tracking values (values which have tracked through from another cue rather than being stored directly in this cue) are shown in light grey.

9.3.3 Moving and copying cues

You can copy or move cues within a cue list or to other cue lists. Either click and drag the cue in the Playback View window (press Window Open then the select button for the cue list), or use Unfold (next section), or you can use a command-line style series of keypresses.

Copy/Move within the same playback:

- COPY/MOVE <playback> <cue> [THRO <cue>] [NOT <cue>] [AND <cue>] @ <cue> ENTER
- COPY/MOVE <playback> <cue> [THRO <cue>] [NOT <cue>] [AND <cue>] ENTER <cue> ENTER

Copy/Move to the end of the same playback:

- COPY/MOVE <playback> <cue> [THRO <cue>] [NOT <cue>] [AND <cue>] @ @
- COPY/MOVE <playback> <cue> [THRO <cue>] [NOT <cue>] [AND <cue>] ENTER ENTER

Copy/Move to a different playback:

- COPY/MOVE <playback> <cue> [THRO <cue>] [NOT <cue>] [AND <cue>] [@[ENTER] <playback> <cue> ENTER

Copy/Move to the end of a different playback:

- COPY/MOVE <playback> <cue> [THRO <cue>] [NOT <cue>] [AND <cue>] [@[ENTER] <playback> ENTER
- COPY/MOVE <playback> <cue> [THRO <cue>] [NOT <cue>] [AND <cue>] [@[ENTER] <playback> <playback>

(<playback> is a playback swop key, <cue> is the cue number and sections in square brackets are optional)

9.3.4 Editing a cue list using Unfold

The Unfold button places each cue of the cue list on one of the playback faders. This allows you to fire and edit each step individually as if it was a stand-alone cue.

-
- 1> *Press the Unfold button, then the Select button of the cue list to be edited.*
 - 2> *The first cues are loaded into the playback faders. The display shows the cue numbers and legends.*
 - 3> *Raise a playback fader to output the contents of that cue (fade times will operate as programmed).*
 - 4> *Various Unfold options are available, the details are below.*
 - 5> *Press Unfold again to get out of unfold mode.*
-

- To edit the contents of a cue: Press Clear to empty the programmer, raise the fader to output the cue, make the changes, press [Record Step], then the Select button for the cue number.
- To merge the programmer into the live step, double tap [Record Step].
- To change the times or cue linking for the cue, press [Edit Times], then the Select button for the cue, then set the times (see Timing on the following page)
- To Insert a new cue, set up the look for the new cue, press B [Insert Step], then press the playback button where you want the new cue to go. All following cues will be shifted on by one and the new cue will be given a number in between the two existing cues (for example, if you press playback 3, your new cue will be 2.5).

- To move or copy a cue, press the Move or Copy button, press the select button for the cue you want to move or copy, then press the select button where you want it to go.
- To Delete a cue, press the blue Delete button then the Select button for the cue you want to delete. Press the Select button again to confirm.
- To change the cue legend, press [Set Step Legend] then the playback select for the step you want to change.
- If the cue list has more cues than there are playback faders, you can swop to the next page using softkeys F and G.

9.3.5 Using Update to change tracked cues

Because fixture settings in a cue list are tracked through from previous cues, if you want to edit a setting you need to find the cue where it was originally set.

The Update function will go back through the cue list from the currently fired cue and automatically update the correct cue.

-
- 1> *With the cue list fired, select the fixtures and change them to the settings you want to store.*
 - 2> *Press .*
 - 3> *Press Enter to immediately store the new values to the cue list. Alternatively, the softkeys show a list of palettes and playbacks which can be updated. Select or deselect these as required.*
 - 4> *If you have used the softkey options, press Enter to complete the update.*
-

- If the attributes you have changed were tracked through from a previous cue, Update will update that cue rather than the current one.

9.3.6 Editing a cue list which is running

You can also edit cues in a cue list while you are running it without using Unfold.

-
- 1> *Fire the cue list by raising its fader.*
 - 2> *Use Wheel A to select the cue number you want to change then the to jump to it.*
 - 3> *Press Clear to make sure the programmer is empty.*
 - 4> *Make the changes that you want to the current step.*
 - 5> *Press , then select [Replace], [Merge] or [Insert After] to save the changes (pressing Rec.Step again will select Merge).*
 - 6> *Press the to jump on to the next step.*
-

- You can edit the times for a cue using the Live Time and Next Time buttons (not on all consoles) as follows:

-
- 1> *Fire the cue list by raising its fader.*
 - 2> *Use Wheel A to select the cue number you want to change then the to jump to it.*
 - 3> *Press the Live Time button to set the times for the current step, or the Next Time button for the next step. The Live and Next*

step numbers are shown on the display above the controller wheel.

- 4> *Use the softkeys to set the times, linking and overlap settings you want (see section 7.5.1 on page 162 for description of the times). If you set the [Link to next step] option to On, then the next cue will not wait for the Go button.*
- 5> *Press the to jump on to the next step.*

- The Review button lets you test the live step with the new timings.
- You can also use Unfold to set the times as described in the Unfold section above.

9.3.7 Editing a cue list while recording

You can edit cues while you are in the Record Cue List menu.

- 1> *Press [Cue Number=x] and type the cue number to be edited.*
- 2> *The console will jump to the cue and show the output.*
- 3> *Make the changes that you want to the programming of the current step, or to the timings using [Edit Cue x Times].*
- 4> *Press [Update Cue x] or the Rec Step button to save the changes.*

- The [Update Mode] softkey allows you to set how changes in the cue will be tracked. [Update Mode Forwards] updates the channels in the current cue and tracks following cues until the channels are next changed. The values in cues before this one will not be changed. [Update Mode Backwards] updates the current cue and tracks backwards through cues until the channels were last changed. [Update Mode Both] will update the current cue, tracking backwards through previous cues from the previous change and forwards through following cues to the next change. [Update Cue Only] will just set the current cue.

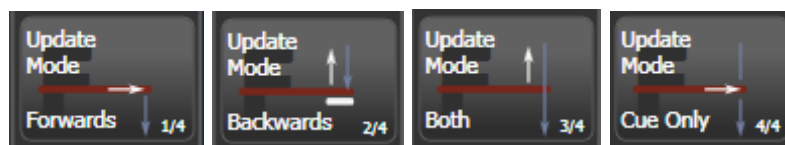

- You can't change the cue number using this menu – if you press [Cue Number] this will change the cue you are editing. Use [Advanced Options] to change cue numbers.

9.3.8 Updating values in a range of cues

You can merge or replace values in a range of cues in a cuelist (or a chase). This can be done either from the keypad or from the Playback View.

From Playback View, press Record then select a cue or range of cues by touching and dragging over the required cues. Select [Merge] or [Replace] (or press Enter to merge). The current programmer will be merged into all of the selected cues.

From the keypad, connect the cue list (or chase) and press Rec Step. Then use the syntax <n> THRU <m> to select a range or <n> AND <m> to select cues which aren't together. The selected cues will highlight in red in the Playback View if you have it open. When you have selected all desired cues press Enter, then select [Merge] or [Replace] (or just press Enter again to merge).

9.3.9 Disabling a cue

You can temporarily disable a cue using the Disable option at the right hand end of the Playback View window. Select the Disabled box and the softkeys let you set [Cue Disabled]. When a cue is set to Disabled it will be skipped. This can be a useful way to remove a cue, but still be able to put it back in later.

9.4 Copying, moving, linking and deleting

This section tells you how to copy or move the entire cue list from one playback to another. For details of copying and moving cues within a cue list please see the previous section.

9.4.1 Copying or moving a cue list

Cue lists can be copied or moved to a new playback, or you can create a linked copy of a playback. Move is useful for tidying up the console.

This operation is exactly the same as for Cues and is described in detail in section 7.4.1 on page 161.

9.4.2 Deleting a cue list

You can delete a whole cue list by pressing Delete then the Select button of the playback to be deleted. Confirm the deletion by pressing the select button again, the [Confirm] softkey, or Enter.

9.4.3 Deleting a cue from a cue list

To delete a single cue from a cue list:

-
- 1> Press the Delete button.
 - 2> Press the Swop button of the cue list.
 - 3> The cues in the cue list are listed on the screen. Use the left hand wheel to select the cue you want to delete, or type in the number of the cue to be deleted.
 - 4> Press [Delete Cue x] to delete the cue.
 - 5> Press [Confirm] to confirm the delete.
-

- Alternatively you can use the Unfold function to delete a cue from a cue list.

9.5 Cue list timing

9.5.1 Time and fade options for Cue Lists

Time settings are independent for each cue in the cue list. The display shows which cue you are working with. You can select which cue is active using Wheel A or softkey A of the Cue Times menu.

See the diagrams in section 7.5.1 on page 162 and section 8.5.2 on page 178 for more information about overlaps and fade times.

-
- 1> Press A [Edit Times] at the main Program menu then the Swop button of the Cue List.
 - 2> To change which cue you are editing, scroll through the list using Wheel A or press [Cue Number] then type the cue number you want to edit and press Enter. The Chase arrow buttons to the right of the Connect button also step through the cues.
-

- You can select a range of cues, enabling you to alter the timings of multiple cues all in one go, by using Wheel B, or in the Playback View window, dragging across the cues you want to select in the grid.
- To set the delay time between pressing Go and the cue starting, press [Delay In] then type a time in seconds and press Enter.
- To set the fade in time of the cue, press [Fade In] then type a time in seconds and press Enter. Both HTP and LTP channels are affected by the fade.
- The fade out time of the cue is set by default to be the same as the fade in time. You can change the fade out time by pressing [Fade Out], then type the time in seconds and press Enter. To set equal to Fade In time, delete the time and leave the box blank.
The fade out time starts when the next cue fires, so if you set the time to 1 second, the outgoing cue would start a 1 second fade out as the new cue begins its fade in.
- The [Delay Out] setting of the cue would normally be used if the console links automatically to the next cue, and sets a wait time before the next cue starts its fade in. So the outgoing cue would start to fade out, and the delay out time would run before the new cue begins its fade in.

9.5.2 Cue linking & Link Offset

Cues in cue lists may be linked together, allowing you to build up complex self-timed sequences. The link options are set using the softkeys and are:

- [Link Wait For Go]: the cue waits for the Go button to be pressed then fires immediately. Link Offset is disabled.
- [Link After Previous Cue]: The cue fires when the previous cue has finished its delay in and fade in times. A Link Offset can be set to add a delay between the previous cue finishing and this cue firing. The offset can be given as a time in seconds, or as a percentage of the fade time of the previous cue.
- [Link With Previous Cue]: The cue fires at the same time as the previous cue fires. A Link Offset can be set to add a delay between the previous cue firing and this cue firing, set either in seconds or as a percentage of the fade time of the previous cue.

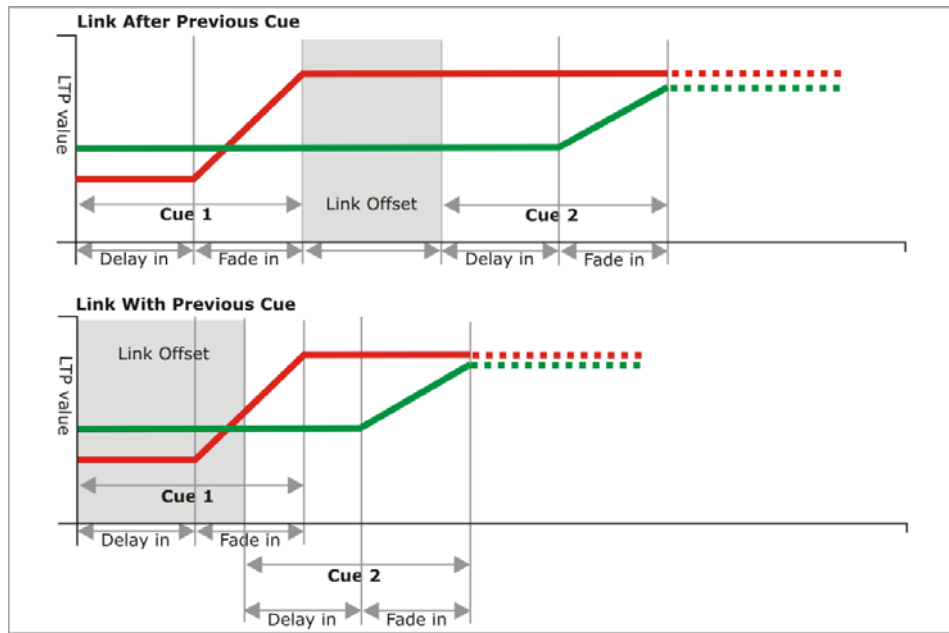

These options allow you to create complex self timed sequences by building up simple steps. For example if you wanted the following effect:

- Go is pressed, fixture one starts fading up over 20s
- After 10s fixture two fades up over 15s
- Both lights stay on for 5s
- Both lights go off in 3s

You could program

- Cue 1 - Fixture 1 @ 100%, Fade In 20s, Link Wait For Go
- Cue 2 - Fixture 2 @ 100%, Fade In 15s, Link With Previous, Link Offset 10s
- Cue 3 - Fixture 1 AND 2 @ 0%, Fade Out 3s, Link After Previous, Link Offset 5s



To obtain the effect which was called "cue overlap" in previous versions of software, use [Link With Previous Cue] and set a percentage Link Offset time. Link Offset of 100% is equivalent to Cue Overlap of 0% and vice versa.

9.5.3 Individual attribute fade times

You can set individual fade times for each IPCGBES attribute group. You can also select which fixtures this is applied to. For example you can make the position change take 2 seconds, but the colour change take 10 seconds.

Additionally you can set individual times for each attribute so you could make the pan fade over a different time to the tilt.

To set times for an attribute group, first select the Set Times menu and go to the cue you want to set as described above, then press G [Next] to go to the second page of options.

1> Press C [Attribute times].

- 2> *All fixtures in the cue will be selected. If you don't want to change the times for any fixtures, deselect them now. You can press the ALL button (below Next Time) to select all fixtures in the cue or Shift+ALL to deselect all fixtures.*
- 3> *Press the softkey for the attribute group you want to change.*
- 4> *Press A [Delay] to set the delay time, or press B [Fade] to set the fade time. Press G [Use global] to remove the attribute group timing and go back to the normal delay/fade times for the cue.*

- You can use [Individual Attributes] to set times for one attribute within the group, for example just Pan from within the Position group. You can also use the Cue View window to set times for individual attributes.

9.5.4 Fixture overlap

For each cue you can set a (linked together) fixture overlap, which causes the Quartz to apply the settings in the cue to each fixture sequentially giving a "rolling" change across the fixtures in the cue. This can create some great effects without much programming on your part.

- Press [Fixture Overlap] (on the second page of the Cue Times menu) then enter 0-100 on the keypad to change how fixtures overlap in the cue. 100% means all fixtures fade together (the normal setting). 0% means that the first fixture will finish its fade before the next one starts. 50% means that the 2nd fixture will start fading when the first one is half way through its fade.
- To change the fixture order when using overlap, press [Set Fixture Order]. Normally this is the order in which you selected the fixtures when you programmed the cue. The Fixture window shows the fixture order in large green numbers. Reorder the fixtures by pressing [Step Number] then type the start number on the numeric keys, then press the fixture Select buttons in the order you want them. For example, to set the order of 8 fixtures, press 1 on the keypad, then press the Select button of the fixture to be first, then the Select button for the second, and so on. You can set several fixtures to the same number if you want them to change simultaneously. If you press a fixture button twice, it will show X and be excluded from the sequence.

Press Exit to finish setting the fixture order.



9.5.5 Running a cue list to timecode

The console can run a cue list automatically to a timecode. This is very useful for complex performances which must be exactly the same time after time, or for unattended operation. Each step in the cue list is assigned a time at which it will run.

The timecode can be read from the system clock, from an internal timecode source, from MIDI or from Winamp. Internal timecode is useful for programming a sequence which will later be triggered by an external timecode source.

-
- 1> *Connect the cue list for which you want to set timecode.*
 - 2> *Press [Timecode] on the top-level menu.*
 - 3> *Press softkey A to select the desired timecode source.*
 - 4> *Press [Record].*
 - 5> *Start the timecode source. If using internal timecode, press [Play] to start it.*
 - 5> *Press the red Go button to step each cue at the time you wish the cue to start.*
 - 6> *Press [Record] when you have finished.*
-

To play back a timecoded cue list, press [Connected Cue Lists] and select the cue list which is to be played. Then press [Timer Disabled/Enabled] to enable the timecode input.

When you start the timecode source (or press [Play] if using internal timecode), each cue will fire as the timecode matches its programmed time.

You can edit the timecode for each cue by using Wheel A to select the cue, then press Enter and type the new timecode for the cue.

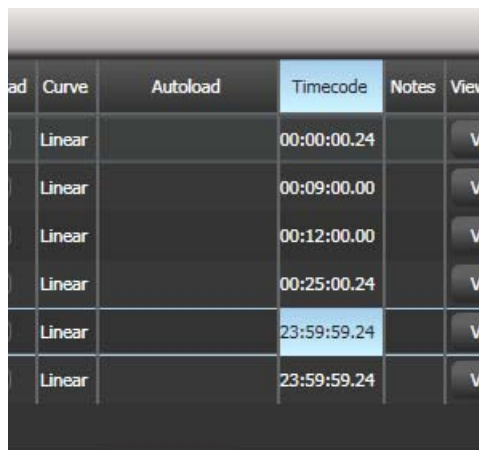

Cue	Curve	Autoload	Timecode	Notes	View
	Linear		00:00:00.24		Vi
	Linear		00:09:00.00		Vi
	Linear		00:12:00.00		Vi
	Linear		00:25:00.24		Vi
	Linear		23:59:59.24		Vi
	Linear		23:59:59.24		Vi

While editing a time you can also use Wheel B to select multiple cues, and use the softkey options to enter a value to change the time of all the cues (offset, add a fixed time or subtract a fixed time).

You can open a timecode display window to show you the incoming timecode – press [Open Workspace Window] then [Timecode].

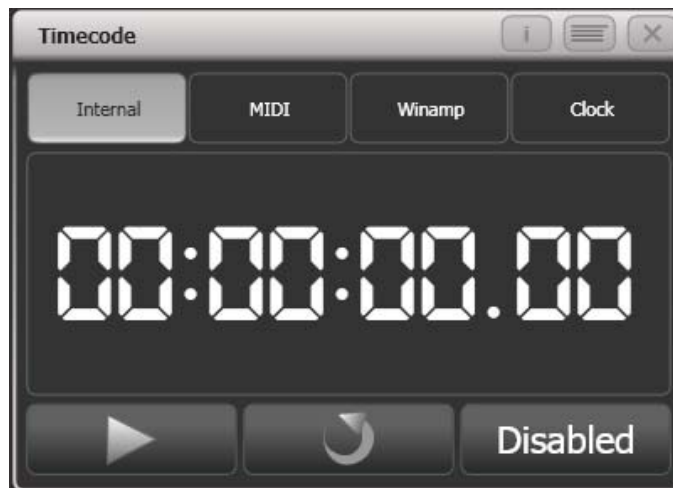

9.6 Cue list options

Cue list options are set from the Playback Options menu. You can enter the playback options menu by doing the following

-
- 1> *At the top level menu press [Playback Options].*
 - 2> *Press the select button for the cue list you wish to edit.*
-

You can show the cue list options in a window by pressing Window Open then the Select button of the cue list, then click the Options tab.

The Cue List options are mostly the same as for Cues and Chases, only the additional Cue List options are described here.

9.6.1 Cue List options - Playback

Blind, Priority, Shape Behaviour are described in the Cues chapter on page 167.

Tracking: Enables or disables Tracking mode (where unchanged settings persist from the previous cues)

Shape Tracking: Sets how shapes are tracked between cues.

Off – Shapes will stop when the next cue starts

On – Shapes will track until stopped or changed in a cue

Local – Follows the tracking option above

Move In Dark: Sets the mode for the whole cue list (see section Tracking)

By default, cue lists run in tracking mode. Only changes in attributes are stored, everything else just continues at the level it was previously set to. Tracking mode is usually used for theatrical performances because it means that if you need to adjust a dimmer level at the start of a scene, you don't have to go through and change the level on every cue for that scene, the change just tracks through the other cues until a new level is stored.

You can enable or disable Tracking mode globally for the whole cue list, or each cue can have Tracking mode set individually from the Playback View window (or Playback Options, [Cue Options]).

Settings are:

[Global] (default): obeys the global setting for the cue list.

[Track]: the cue will track

[Block]: the cue will not take tracking states from previous cues. All subsequent cues will track from the Block cue.

[Solo Excluding Shapes]: No states are tracked into or out of the cue, but shapes will track into the cue, except for dimmer shapes which will not track. This lets you have a cue that solos all levels but allows non-dimmer shapes to continue.

[Cue Only]: changes in this cue will not track to subsequent cues. Unchanged states from previous cues will be restored in subsequent cues.

[Solo]: No states are tracked into or out of a solo cue. States from previous cues will track to subsequent cues but will not appear in the solo cue.

[Block Shapes]: Any tracked shapes will stop from this cue. Other attributes will continue to be tracked. This lets you create a point where you can guarantee all shapes will stop.

Move In Dark (MID) functions on page 189).

Off – obeys settings for individual cues

Disabled – no move in dark even if set in cues

Early – moves as soon as fixture is off

Late – moves in the last cue before the fixture is needed

9.6.2 Cue list options – Handle

All these options are described in the Cues chapter.

9.6.3 Cue list options - Fader

Fader Mode: Sets how the cue list fader behaves.

Fader Mode Intensity Kill With Off - the fader masters the overall HTP level and the cue list remains active (connected) even when the fader is lowered to zero.

Fader Mode Intensity Kill At 0 - the fader masters the overall HTP level and the cue list is killed when the fader is lowered to zero.

Manual Crossfader - the fader behaves as a manual crossfade control, and the cue list will automatically step on to the next cue when the fader reaches the top or bottom of travel.

Fire first cue: Sets whether the first cue automatically fires when the fader is raised.

9.6.4 Cue list options – Effects

All these options are described in the Cues chapter.

9.6.5 Cue list options - Release

Release Mask and Release Time are described in the Cues chapter

Cue Release: allows you to create an overlay cue list with gaps in it where the fixtures will return to their previous state. For example you could create a cue list where every alternate cue sets the fixtures to white, with the in between cues being blank. If this option is on, the fixtures will bump to white then return to the colour set from a previous look.

9.6.6 Renumber all cues

Allows you to renumber the cue list if the numbering has got mixed up after lots of editing.

9.6.7 Cue Options

This option allows you to change settings for each cue in the cue list. To select the cue number to edit, use the left hand wheel or press softkey A then enter the cue number on the numeric keypad.

- [Curve] allows you to set a different fade curve for the cue; this affects how the fade progresses from one cue to the other (for example you can select a fade which starts off slow, speeds up in the middle and then slows down at the end). Press [Curve] then select a new curve from the softkeys. The effect of the various curves is described in section 13.7 on page 251.
- [Link] can be set to Wait for Go, With Previous Cue or After Previous Cue. See section 9.5.2 on page 196.
- [Move in Dark] opens the menu for Move In Dark options, see section Tracking
- By default, cue lists run in tracking mode. Only changes in attributes are stored, everything else just continues at the level it was previously set to. Tracking mode is usually used for theatrical performances because it means that if you need to adjust a dimmer level at the start of a scene, you don't have to go through and change the level on every cue for that scene, the change just tracks through the other cues until a new level is stored.
- You can enable or disable Tracking mode globally for the whole cue list, or each cue can have Tracking mode set individually from the Playback View window (or Playback Options, [Cue Options]).
- Settings are:
 - [Global] (default): obeys the global setting for the cue list.
 - [Track]: the cue will track
 - [Block]: the cue will not take tracking states from previous cues. All subsequent cues will track from the Block cue.
 - [Solo Excluding Shapes]: No states are tracked into or out of the cue, but shapes will track into the cue, except for dimmer shapes which will not track. This lets you have a cue that solos all levels but allows non-dimmer shapes to continue.
 - [Cue Only]: changes in this cue will not track to subsequent cues. Unchanged states from previous cues will be restored in subsequent cues.
 - [Solo]: No states are tracked into or out of a solo cue. States from previous cues will track to subsequent cues but will not appear in the solo cue.
 - [Block Shapes]: Any tracked shapes will stop from this cue. Other attributes will continue to be tracked. This lets you create a point where you can guarantee all shapes will stop.
- Move In Dark (MID) functions.

- [Move In Dark Inhibit] disables the Move In Dark function for this cue.
- [Tracking] disables or enables tracking for this cue.
- [Legend] allows you to set a legend for the cue which is displayed on the cue list display.
- [Notes=] lets you enter a note for the cue ("Leaves stage pursued by bear" or "wake up spot operator").
- [Autoload] see next section
- [Cue disabled] allows you to temporarily disable this cue, see section 9.3.8.

10. Capture visualiser

From Titan v10, the Capture visualiser is integrated into the console. This can provide a realistic simulation of your lighting which is really useful for pre-programming or making changes in blind mode during a show.



To open the visualiser, select [Capture Visualiser] from the [Open Workspace Window] menu.



Always pre-program using palettes, because things never quite line up the same in a visualiser as they do in the real world. Using palettes means that you just need to reprogram the palettes when you get onto the real rig, rather than having to change lots of cues separately.

The previous visualiser is still available using the [Legacy Visualiser] workspace window.

10.1 Setting up the rig

10.1.1 Setting up the stage and rigging

To help you see what your rig will really look like you can add fixed elements of staging and rigging.

Open the Capture Visualiser Settings window from the Open Workspace Window menu, or the Open Settings context button in the Capture window. Click the Stage tab.

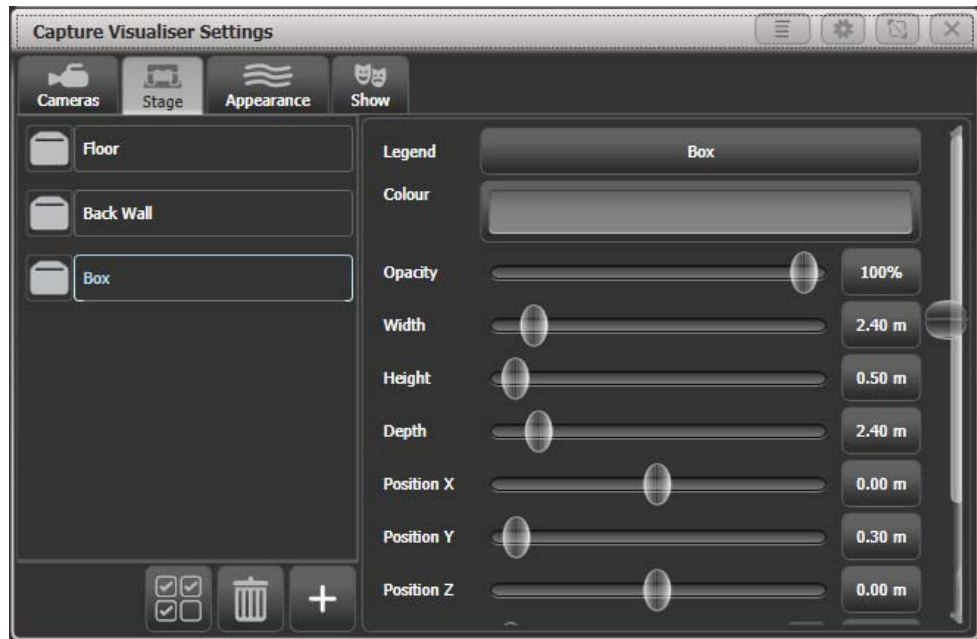

“Floor” and “Back Wall” are provided by default. You can add other objects by clicking the Plus button at the bottom of the list.

Click on the object in the list on the left hand side to position and angle the object using the controls on the right. You can either type exact numbers or use the sliders. You can set a legend and colour for each object.

10.1.2 Setting up fixtures

Fixtures are automatically placed into the visualiser when they are patched if the Auto Update switch in the Capture Settings “Show” window is set to On.

If you load a Titan show from a previous version, or have some patched fixtures which are not placed in Capture, use the [Edit Fixtures] [Update Personality] option on the Patch menu to place missing fixtures into the visualiser.

Fixtures are positioned using the wheels. Select one or more fixtures using the Fixture select or Group buttons and turn them on by pressing Locate. Press the [Position – Orientation] context menu button to switch the wheels to Visualiser mode (or press Softkey G at the top level menu until the display shows Wheels-Visualiser.)

Select Position attribute, then use the wheels to change the X/Y/Z position of the fixture(s). If you select multiple fixtures, pressing the [Scale-Fan] context menu button or the Fan button allows you to evenly spread out the fixtures. The Fan curve/group/split options also work.

Touch above or below the wheel value to nudge the setting up or down by one step. For rotation this will be 45 degrees.

If you are viewing the stage from the front then
 X moves left and right
 Y moves up and down
 Z moves towards and away from you

Press the Position button again to switch the wheels to Orientation mode. The wheels will now pivot the fixtures in the X/Y/Z axes. Again

you can use the Fan button to give a spread of angles on multiple fixtures.

The X/Y/Z rotation operates like a 3-axis camera gimbal – imagine the fixture within three pivoting rings (see left hand picture below). In some orientations, the X and Z rotation will seem to do the same thing and some rotations seem to be impossible to achieve – this is called gimbal lock and happens when two of the “rings” are lined up with each other (right hand picture below). Change the Y rotation by 90 degrees to enable you to achieve other angles.

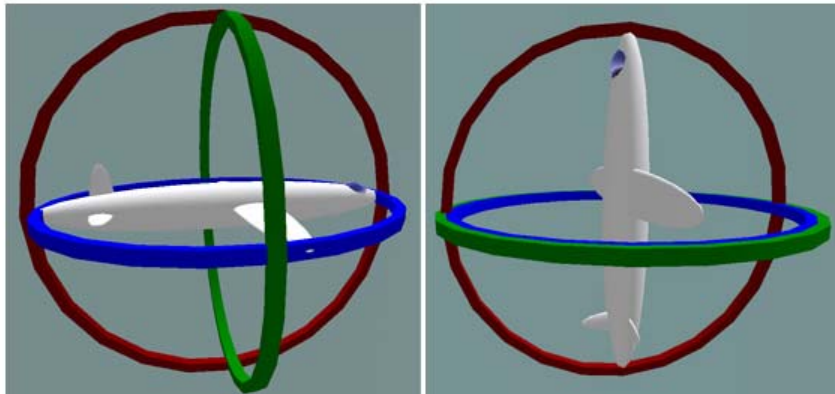

Illustration by MathsPoetry

Press the Position button a third time to switch the wheels to Rotation mode. This is similar to Orientation but if you have multiple fixtures selected, the fixtures rotate as a group about the middle fixture.



It's easier to see what position fixtures are in if you change the tilt angle so they aren't pointing straight down (or up). It's always useful if you have an actual fixture of each type connected to help you get them pointing the right way, but you can change this later if not.

10.1.3 Setting up cameras (views)

Four cameras (selectable views) are provided by default but you can add more.

The context menu buttons provide camera options.

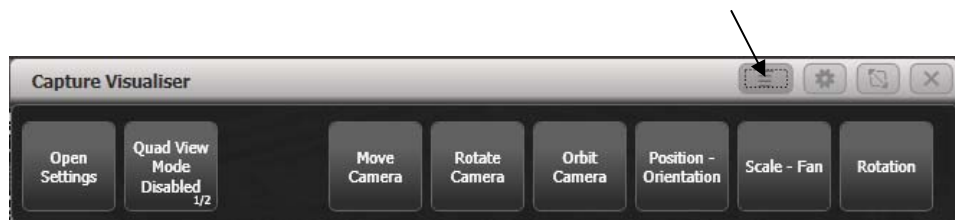

Camera controls are in the Capture Visualiser Settings window which you can open using the [Open Workspace Window] button or using the [Open Settings] context button.

The view buttons across the top select the four default views. Press the Plus button at the right hand side to add a new view.

The top button on the left toggles between single view or quad split mode. If quad split is selected, the other 4 buttons select which view you are controlling.

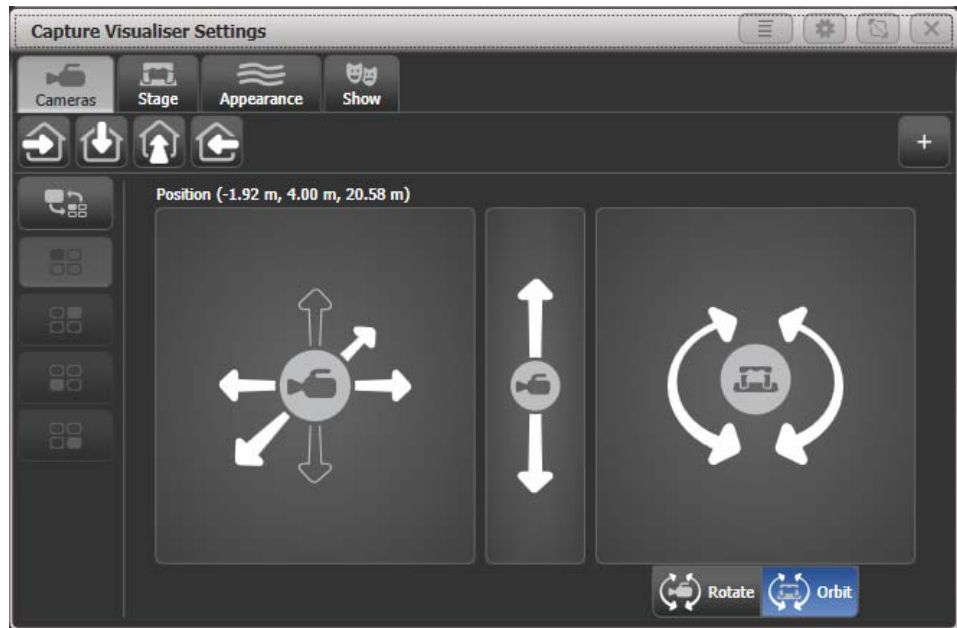

The left hand pad moves the camera left and right, and towards and away from the stage.

The middle pad moves the camera up and down.

The right hand pad can be set to rotate or orbit mode

- Rotate: turns the camera to face left, right, up, down
- Orbit: orbits the camera around the stage in a circular path keeping it pointed at the same object.

Press the [Move Camera] context button to link camera movement to the wheels. This also opens the Set Coordinates menu with softkeys allowing you to enter numeric camera positions.

Press the [Rotate Camera] or [Orbit Camera] context buttons to link camera rotation or orbit to the wheels and allow numeric entry on the softkeys.

10.1.4 Capture Appearance options

The Appearance tab of the Settings window allows you to set the following parameters:

- Ambient lighting (background light level)
- Atmosphere (haze/smoke density)
- Atmosphere contrast (mix between haze and moving smoke effects – 0%=all haze, 100%=all smoke)
- Atmosphere speed (rate of change of moving smoke effect)
- Exposure adjustment (camera brightness control)
- Bloom amount (visible halo around lights)
- Rendering settings detail (this affects the refresh rate of the simulator. If you have a lot of beams visible you may need to change this to Low to improve the refresh rate).

10.2 Visualising using Capture

Mostly you don't have to do anything special with Capture once you have it set up. Just operate the console as normal and Capture will show you what would be happening on the stage.



If you use the visualiser a lot, it's very handy to have an external monitor to show it on. Otherwise you constantly have to switch between the workspace windows and the visualiser window.

10.2.1 Fixture selection

If you select fixtures on the console, the fixtures will highlight in Capture so you can see where they are in real life.

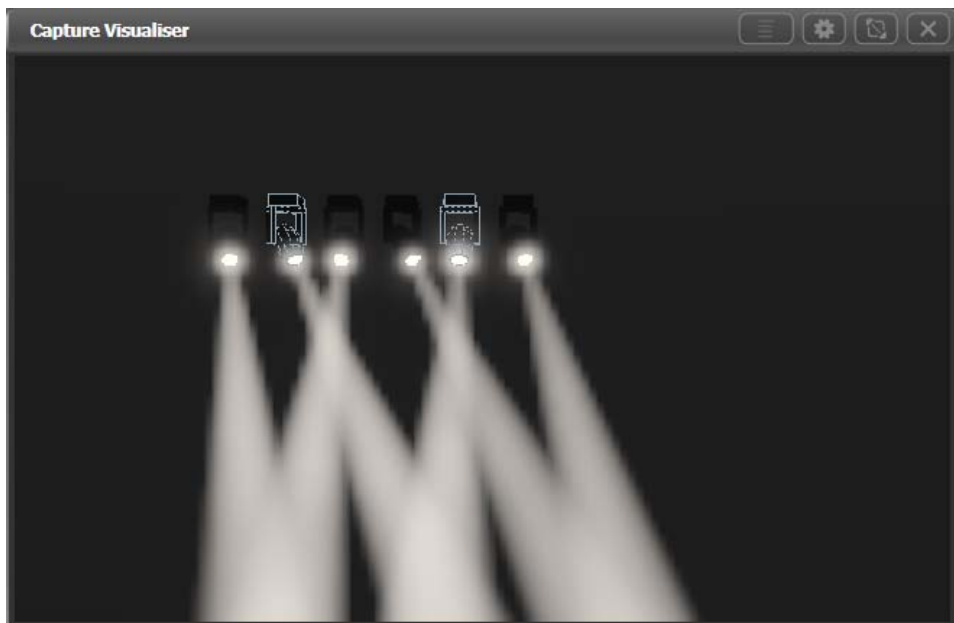

10.2.2 Camera views

Capture lets you can see how the lighting will look from any seat in the house. Even if you're in the venue with the full rig in front of you this means you can see the look without having to run all over the venue.

Set up multiple cameras as described in the previous section and you can either click between them or show the 4 standard camera views as a quad split.

10.3 Capture Show files

The Capture stage is automatically saved within the Titan showfile. The Capture stage can also be exported and imported separately from the Titan show. This allows standard stages or rigs to be transferred between Titan shows.

Select the Show tab in the Capture Settings window to export and import shows.

10.3.1 Exporting shows

Exported Capture shows can be loaded into other Titan shows or into the full version of Capture for producing documentation.

10.3.2 Importing shows

Shows can be imported from the full version of Capture, this can be useful to import existing stage structures or rigging designs.

You can import fixtures from full Capture but you need to ensure that fixtures are correctly patched in Capture to match the patch on the console. There is no way to edit an externally created Capture patch on the console.

Some fixture types and other Capture elements may not work when you import a show that has been created in full Capture. We recommend you use the auto-patch function to allow the console to patch the fixtures into Capture.

10.3.3 Clearing the capture show

The Wipe button at the bottom of the Show tab will clear the current Capture show.

If you need to reload patched fixtures from your Titan show into Capture, select the [Edit Fixtures] [Update Personality] option on the Patch menu. This will place all patched fixtures from the Titan show into the visualiser.

11. Running the show

So, it's showtime. This chapter describes the functions of the console which are useful when running a show.

11.1 Playback controls

11.1.1 Back up the show

At regular intervals while you are programming, and when you have finished programming (or you've run out of time) and it's showtime, the most important thing is to save the show (see section 2.3.6 on page 34 for instructions). It is important to also back up the show by saving it to a USB drive, enabling you to swap to a different console if there are problems.

11.1.2 Label the console

When you are running your show you will need to know where everything is. Use the Legend functions to set onscreen labels, or you can't beat the low tech method of marker pen and tape.

11.1.3 Master faders

Any playback fader on the console can be assigned to be a master fader, which allow you to set the overall intensity of various areas of the console. Different types of master fader are available:

- Grand Master controls the intensity of all output from the console.
- Swop and Flash masters control intensity of the swop/flash buttons
- Preset master controls intensity of the preset faders
- Playback master controls intensity of all playbacks.

To assign master faders, go to System mode and select [Assign Mastering].

By default, master faders are set to have a transparent lock, which makes the master fader remain in position even when the playback page is changed. If you don't want this to happen you can change it by pressing [Playback Options] from the root menu then press the Swop/Select button of the master.

11.1.4 Speed and Size Masters

Playbacks can be assigned to a Speed Master and/or a Size Master which allow you to control the speed and size of shapes or effects stored in a cue (or in the case of chases, to modify the speed of the chase).

There are eight possible Speed Masters and four Size Masters which allow you to separately control the parameters of different playbacks, if you need to.

A playback is assigned to a Speed/Size Master by pressing [Effects] then [Speed Source] or [Size Source] in the Playback Options. The following speed sources are available:

- Local (default - no Speed Master)
- BPM 1-4 (override the local speed with a fixed value from the master)
- Rate 1-4 (proportionally modify the local speed using the master)

There is also a Rate Grand Master which, if used, proportionally controls the four Rate Masters (BPM Masters are not affected).

To use Speed or Size Masters you will need to assign some handles on the console to act as the Master faders. Switch the console to System mode and select [Assign Mastering]. Special key profile options are available for Speed Masters, BPM Masters default to Tap Tempo.

Speed or Size masters can have various scales, 0-100%, 0-200% and so on. A 0-200% scale would allow you to slow down and speed up the speed to double the programmed setting. Scales are set in normal (non-system) mode by selecting [Playback Options] then press the Select button of the master.

11.1.5 Group Masters

You can assign a fader to control the master intensity of each fixture group. To do this you simply save (or move) the group button to a handle with a fader.

The blue button will then select fixtures in the group and holding the blue button gives you softkey options to filter the selection according to a pattern.

Press [Playback Options] and then the blue select button above the fader to set the fader mode to the following:

- Scale master (proportional control). Scale masters can be set to variable scales of 100%, 200%, 400%, 600% and 1000%. The higher settings allow you to increase an intensity above its recorded level.
- HTP (override level if higher than current output)
- Limit (sets hard limit)
- Take Over (place fixture and its intensity in programmer when level matched)
- Disabled (ignore fader)

If the playback fader has a display area on the screen, the level and mode of the master will be shown.

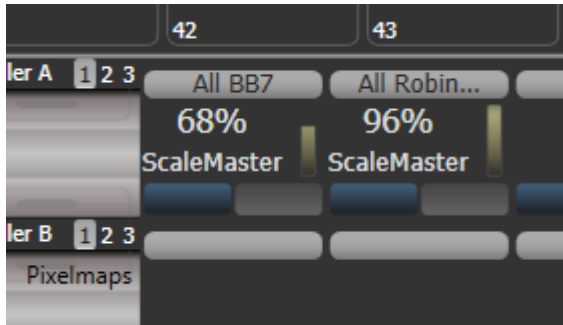

- When a group master is set to disabled or moved to a handle without a fader, it will become locked at the current fader level. Re-enable or move back to a fader to adjust the level.



You can release all masters by pressing Release then [Release All Masters]. This can be useful if something is being controlled by a master but you are not sure where it is.

11.1.6 Flash and swop buttons

The Flash and Swop buttons on the playback faders may be used at any time to flash and solo cues and chases. The Flash button adds the playback into the current output, the Swop button turns off all other output. . The Flash button can also be set to Flash With Times which will use the pre-programmed timings of the cue when flashing.

You can reallocate the functions of the Flash and Swop/Select buttons on the console using Key Profiles – see section 13.1.4 on page 233. A useful alternative function is Preload which allows you to pre-position the attributes of the fixtures before you raise the playback fader, which is handy for avoiding unwanted movements (any fixtures which are already active in another playback will not change when you use Preload). You can also allocate Go and Stop buttons for cue lists and chases. To quickly change the key profile, hold Avo Shift and press [Edit Key Profile].

The screen relating to each playback faders shows the allocated function of the blue and grey buttons.



11.1.7 Playback priority

You can set playbacks to high priority if you do not want them to be overridden by other playbacks using the same fixtures. For example, if you have a couple of fixtures acting as a spotlight, but they are also programmed into some colour washes, you probably want the spotlight cue to take priority over the colour washes. See section 7.6.1 on page 167.

11.1.8 Locking a playback onto the same handle on every page

Sometimes you might want to keep a playback accessible on a handle no matter which page you are on. The [Handle Paging] option in the [Playback Options] menu lets you do that without having to copy the playback onto multiple pages.

[Locked] ensures the playback always appears on that handle no matter what page is selected. Any other playbacks programmed on that handle on other pages will not be accessible.

[Transparent Lock] means the playback will appear on the current page only if the handle is empty on that page. If the handle is in use on the new page, then that playback will appear instead of the locked one. This can be useful if you only need the locked playback to appear on certain pages but wish to reuse the handle on other pages.

- Lock options are also available for master faders.

11.1.9 Viewing active playbacks

The Active Playbacks window shows details of which playbacks are active. This provides an easy way to see what is currently running.

The top line of the button shows the page number and tells you where on the desk the playback is stored. The second line shows the legend, and the third line shows which attributes are affected by the playback.

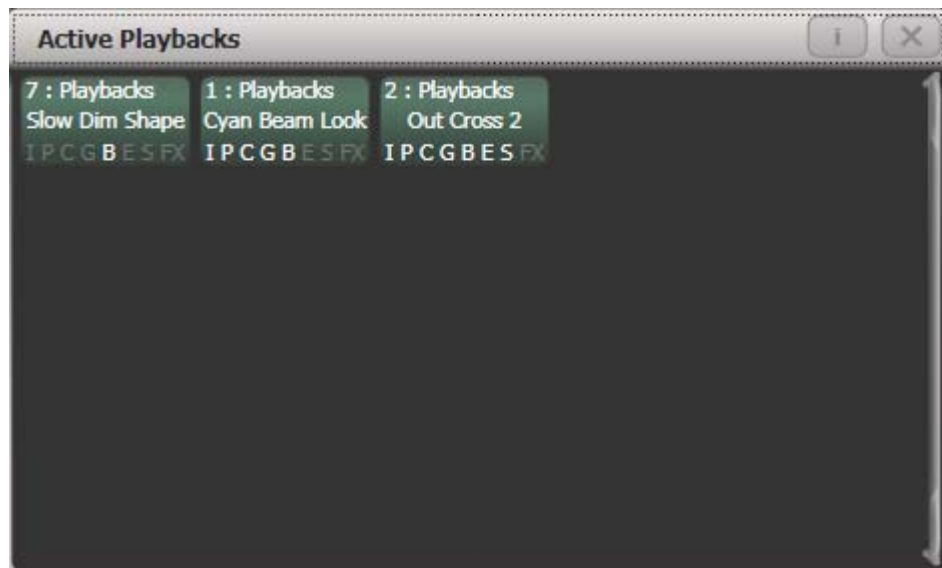

Click on a playback to instantly kill it. You can also press [Playback Options] followed by the playback in this window to change parameters of the playback.

11.1.10 Blind mode

You can set the console to Blind mode by holding down the Avo button and selecting [Blind], or some consoles have a dedicated Blind button. This allows you to program palettes or cues without affecting the look on the stage (changes will be shown in the Visualiser window).

You can convert Blind output to Live output with a fade. This is useful to set up a live state in blind mode then output it without having to save to a playback. It also allows you to select multiple palettes then fade to them all at once.

To convert blind to live, type a number to set fade time then press the Blind button.

If any attribute fade times have been set in the programmer, these will be used instead of the fade time you type.

11.1.11 Busking with palettes

If you have not had as much programming time as you would have liked, you might need to make up some additional effects during the show. This is sometimes called "busking", and is where the fun starts!

You can create instant variations by recalling palette values to modify your existing cues. Palette values can have fade times saved with them, or you can set a fade at showtime for added effect.

-
- 1> *Select some fixtures which are already in use on stage.*
 - 2> *Type "2" (or any time, in seconds) on the numeric keypad.*
 - 3> *Touch a Palette button to recall a palette.*
 - 4> *The selected fixtures will change to the new palette over a time of 2 seconds.*
-

If the palette contains programmed times, you can change the Key Profile of the palette button to set whether the programmed times will be used or not. (Press Avo Shift+[Key Profiles], then [Palettes] to set the key profile). Options are [Palette is fired ignoring its times] or [Palette is fired with its times]. You can also set whether the palette will take precedence over a flashed cue or not. A time entered manually as above will always override a programmed time.

When a fade is entered, you can also change the "Fixture Overlap" using softkey A. This allows you to create "roll" or "peel" effects when using a series of fixtures. With overlap=100%, all fixtures change at the same time. If overlap=50%, the second fixture will not start its fade until the first fixture is half way (50%) through fading. The order of the fixtures is set by the order in which you selected them.

The palette fade time remains active while the Palette Fade menu is open. Press Exit to leave the menu and return to instant palette recall.

If you apply a palette with a fade time, then it will be overridden by the next cue (so if you fade to green using a palette, then fire a cue which sets those fixtures blue, they will go blue). If you apply a palette without a fade time, it will go into the programmer and override any subsequent cues (so if you use a green palette with no fade, the fixtures will be locked in green until you press Clear).

Having the palette overridden by the next cue is quite useful when "busking". If you need to "snap" a palette but still have it overridden by the next cue, set a fade time of 0 (leaving the Palette fade menu open).

When programming your palettes, group all the colour palettes in one area of the console, position palettes in another area, and so on. This helps you to find them when the show is running and the pressure is on.

If you are lighting a band, make position palettes for every person on stage so you can spotlight them for those unplanned solos.

You can use the Off function (see section 7.3.5 on page 160) when programming to set some cues to only affect position, and other cues to set colours, gobos, add shapes, and so on. By combining two or more cues you can produce a much wider range of effects than if all your cues set all the attributes. However, for this to work well you need to make sure you know what attribute is going to be affected by

each cue; as if you fire two “colour only” cues then nothing is going to light up.

11.2 Using multiple on-screen workspaces

On the screen you can configure different “workspaces” which store how the various windows are displayed. This allows you to quickly recall different setups. Workspaces are stored and recalled from the touch buttons to the left of the menu buttons, or may be stored to any grey button on the console.

You can also create a Set List which will automatically recall a workspace layout for each song.

11.2.1 View menu

Pressing Window Open (by numeric keys) takes you into the View menu. From here you can set up what is shown on the screen.

- [Window Options] allows you to reposition and resize windows.
- [Open Workspace Window] gives a list on the softkeys of all the possible windows, allowing you to open the one you need.

11.3 Organising the console

If the layout of the fixture buttons, palettes or playbacks has become a bit mixed up during programming, you can use the Move function to move recorded items around and produce a better layout. When an item is moved, all links to other recorded items are retained.

11.3.1 Using the Move function

To move fixtures, palettes, groups and playbacks is very simple.

-
- 1> Press Avo and the Copy button to select Move mode.
 - 2> Press or touch the select key(s) of the item(s) to move.
 - 3> Press or touch the select key of the destination.
-

When moving a range, it is possible to select a range containing different types of items, and there can be gaps between them. In this case, you can set option B to [Bunch Up] to have all of the gaps in the range removed.

[Swap Items if Required] will attempt to reposition any existing handles which are in the way of the move. This is useful when rearranging handles on a page which is nearly full.

- If there is not enough space, (there is an item in the way or there is not enough space before the end of the page) then the action will not be completed.
- Press the Latch Menu button to keep Move mode active if you have a number of things to move around.

11.4 Set List window

The Set List window is a handy way of linking playback pages to songs/events in your show which you can then easily step through. You can also make notes, handy for avoiding bits of paper lying around. You can have multiple set lists in a show.

To open the Set List window, click [Open Workspace Window] then [Set List].

The Set List feature works best if you arrange your playbacks to have a page of playbacks for each song in the show.

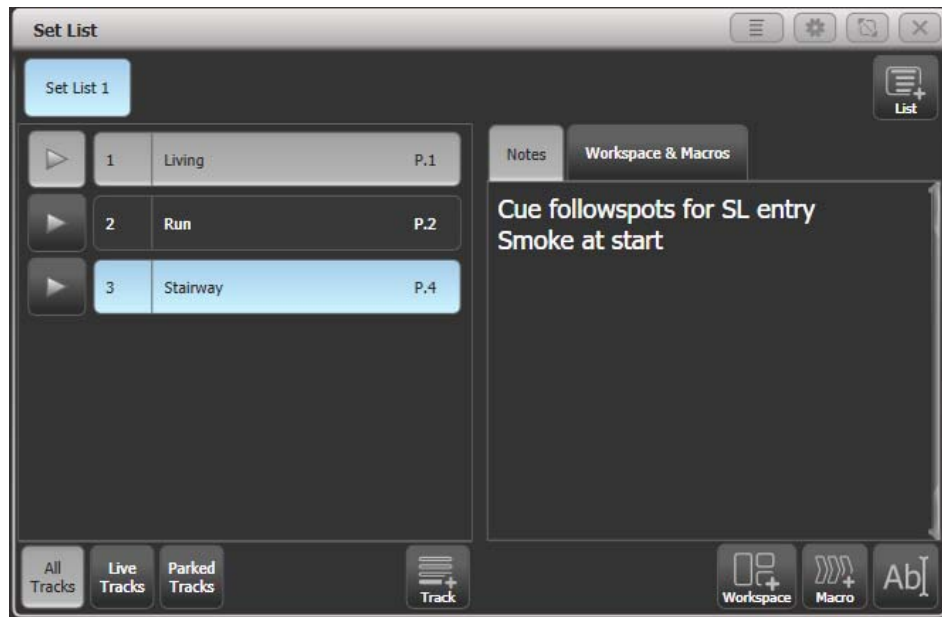

A set list is made up of tracks. When a track is added it automatically links to the current page. Pressing the play button next to the track will automatically select the correct playback page (except on Pearl Expert, because the rollers cannot be moved automatically).

11.4.1 Creating a Set List

To create a Set List, click the plus button in the top right corner of the window. You can choose Empty, Pages, and Build. Pages will automatically create a set list using the legends of your existing playback pages, one page per track. Build allows you to select the pages in the order you want them. Or you can manually add a track using the plus button below the track list.

11.4.2 Configuring tracks

Enter notes by selecting a track and clicking the text entry button, bottom right, or the Edit Note context menu button.

- You can temporarily remove a track from the set list using the Park Track context menu button.
- If you prefer to operate by using the Page+/Page- buttons, you can change the function of these buttons to step through the tracks in the set list window, using the Page Mode context menu button. When Page Mode is set to Set List, the Page+/Page- buttons are reassigned to step through tracks in the Set List, and the playback pages will automatically change as programmed in the Set List. Set Page Mode to Normal to restore normal operation. (Not available on Pearl Expert).
- You can copy, move and delete tracks using the appropriate function buttons on the console.
- You can change the legend of the Set List or of individual tracks using the [Set Legend] option.

11.4.3 Track Workspace and Macro links

You can trigger macros and workspace shortcuts from tracks using the [Workspace] and [Macro] buttons in the bottom right hand corner of the window.

To add a workspace link to the current track, click [Workspace], then either click a workspace shortcut or press the [Record Workspace] softkey to save the current workspace.

Macros can be added either to the whole Set List or just to the current track. Set List macros will fire every time a new track is selected, this is useful for setting the console to a preset state at the start of every song. Track macros will just fire for that individual track.

To view or edit the workspace links and macros, click the Workspace & Macros tab on the right hand half of the window. The window will then show a button for each programmed link.

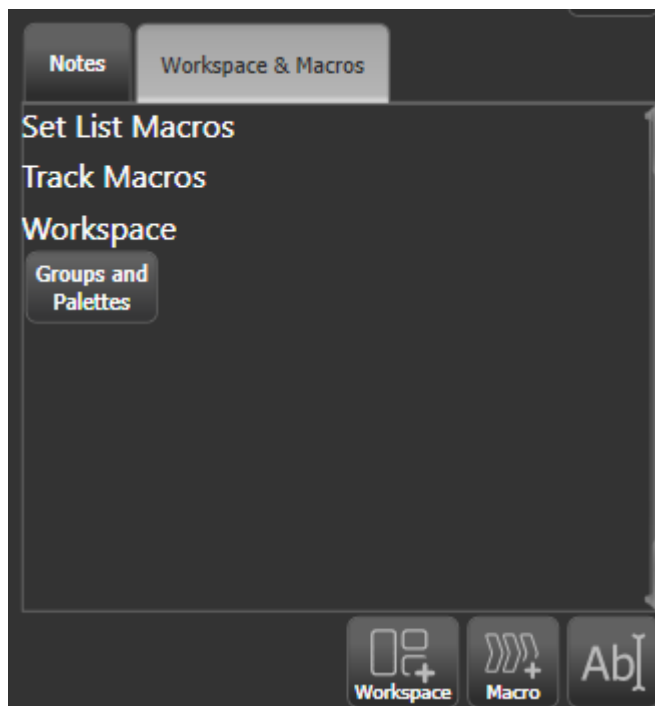

You can fire the macro or Workspace shortcut by clicking on the link button. Delete the button by pressing Delete then clicking the button, then press [Remove].

11.4.4 Playback control Macros

Key Macros allow you to record a sequence of actions on the console then play them back (either instantaneously or as a timed sequence). This can be very useful for reducing a complex sequence of actions to a single button push. See section 2.3.8 on page 35 for more details.

Some special preset macros are available to help with controlling playbacks when used with a Set List.

[Fire First Playback] - fires the first playback on the current page.

[Fire First Playback Page 1] - fires the first playback on page 1, regardless of current page.

[Fire Playback 1] - fires the playback with user number 1.

[Kill First Playback] - kills the first playback on the current page.

[Kill First Playback Page 1] - kills the first playback on page 1,

regardless of current page.

[Kill Playback 1] - kills the playback with user number 1.

[Release First Playback] - releases the first playback on the currently selected page.

[Release First Playback Page 1] - releases the first playback on page 1, regardless of current page.

[Release Playback 1] - releases the playback with user number 1.

[Release Me] - releases the associated playback (cuelist).

[Goto My Cue 1] - go to cue 1 of the associated cuelist.

11.5 MIDI, DMX or audio triggering

You can set up the console to allow most features to be triggered by external events. This is very useful in complex shows or when using in an automated setup.



Audio trigger (sound to light) requires special hardware which is currently only available on the Quartz and Arena consoles. The line in socket on other consoles cannot be used for audio trigger.

11.5.1 Connecting remote trigger sources

To connect a MIDI source, connect it to the MIDI in connector on the console.

DMX inputs are connected to one of the DMX output connectors using a DMX male to male gender changer cable. (This is a simple plug to plug cable with all pins wired straight through, i.e. 1-1, 2-2 and 3-3).

Audio input is connected to the dedicated audio in jack (not the line in jack on the motherboard).

The Arena console has a switch trigger input on a jack socket.

11.5.2 Setting up remote triggering

Enter System mode and select [Triggers]. The Triggers window will open.

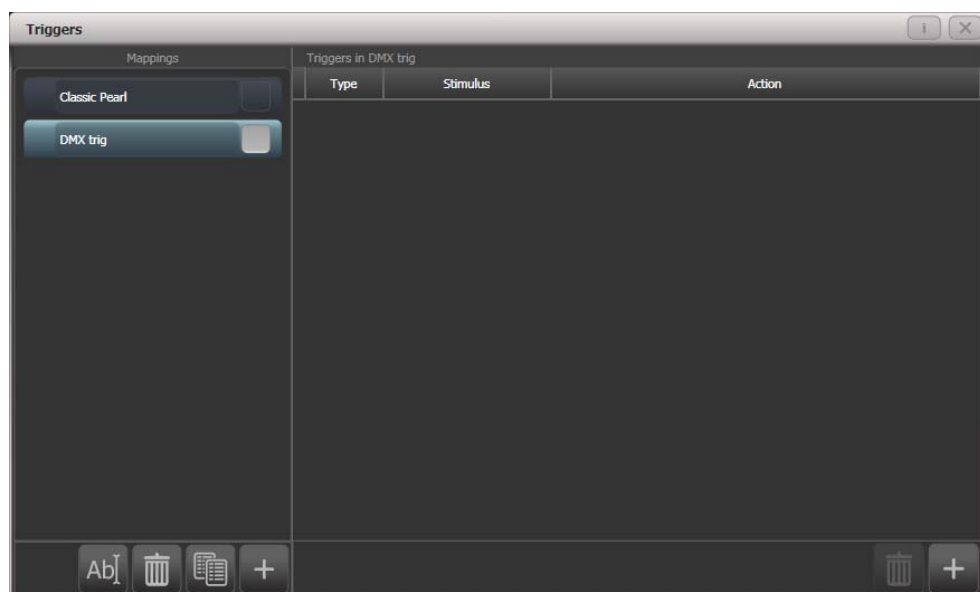

The left hand side of the window has a list of trigger sets. The “classic Pearl” MIDI trigger implementation is provided as one of these. Each set of triggers can be enabled or disabled using the button at the right hand end of the mapping name.

-
- 1> Add a new mapping using the + button at the bottom of the left hand column, and enter a name for it.
 - 2> Add a trigger to the mapping using the + button in the right hand column or softkey [Add trigger].
 - 3> Select [Trigger Type] as [Hardware] to trigger a physical button press or fader move, or [Item] to trigger a screen button (playback, fixture, palette, group or macro).
 - 4> Press the button or move the fader to be triggered. The screen will update to show you what has been triggered. For Item triggers you can select different actions using the [Action] softkey.
 - 5> Press [OK]. You have now set up the console action which is to be triggered.
 - 6> Now you need to set up the external stimulus which will cause the trigger. Select [Trigger Type] as DMX, MIDI or Audio. For DMX, press [DMX Port] to select which DMX port you are using for DMX input. You will need to switch the DMX port to Rx mode using the menu option provided.
 - 7> Generate the stimulus from your device (for example play the MIDI note, or turn on the DMX channel). If the [Learn] option is set to On, the console will automatically detect the stimulus. Or you can enter the details using the softkey options.
 - 8> For DMX triggers you can select the address for triggering. For MIDI triggers you can select MIDI channel, MIDI Command, Value, and Level (velocity) ranges. For audio triggers the [Band] option is used to select which frequency band will cause the trigger. See section 11.5.5 for Audio.
 - 9> Press [Add] to add the trigger to the list.
 - 10> The window will show the trigger stimulus and the action to be carried out.
-

You can continue to add other triggers to the mapping.

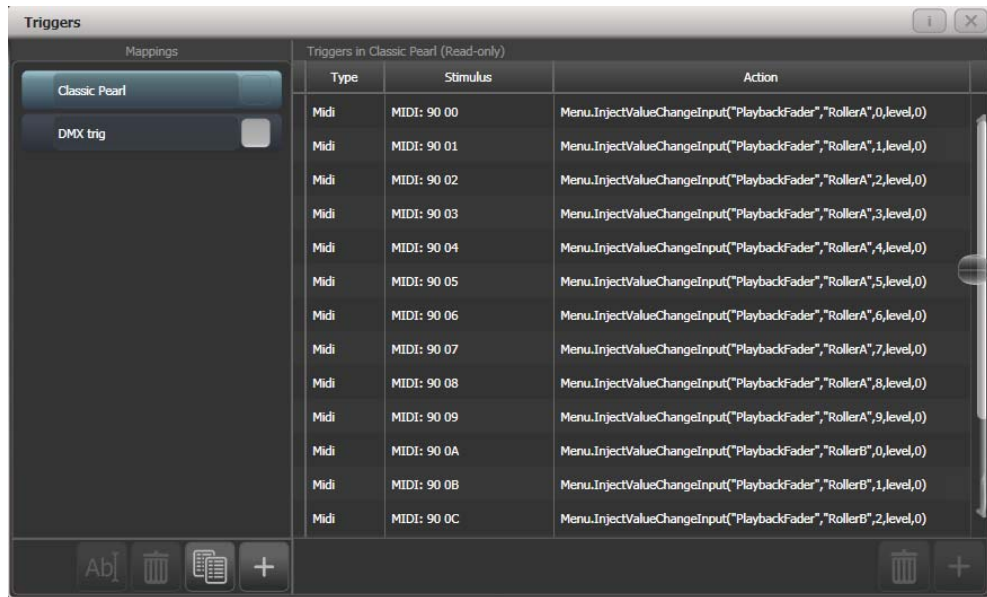

To delete a trigger from the mapping, select it in the list and press the rubbish bin button at the bottom.

To delete a complete mapping, select it and press the rubbish bin button at the bottom of the left hand column.

11.5.3 Classic Pearl MIDI triggers

This trigger map sets up the console to mimic the MIDI setup of the classic Pearl software. It is used for triggering playbacks from MIDI.

In this section MIDI commands are shown in hexadecimal using the \$ sign, for example \$Cn, where n represents the MIDI channel being used. n is a number from 0 to 15 representing MIDI channels 1 to 16. So to send "program change value 4 on channel 2" you would send \$C1 \$04 (193 004 in decimal).

Most MIDI equipment or software will do all this for you without you needing to know about the numbers.

Set playback page : *program change (\$Cn xx)*

Page	1	2	3	4	5	...	28	29	30
xx	\$00	\$01	\$02	\$03	\$04	...	\$1B	\$1C	\$1D

example \$Cn \$02 Console changes to Page 3

Turn on a playback: *note on (\$9n pp ll)*

Note number (pp) = playback number, from 0 - 14 (decimal)

Key velocity (ll) = playback level, from 0 - 127 (decimal). 127=Full

example \$9n \$03 \$40 Playback Fader 4 at 50% level.

(Note that Playback Fader numbers start at zero, so subtract one from the number on the console to get the MIDI note number).

To turn off a playback, send a note on command with velocity=0. The console does not recognise MIDI note off (\$8n) commands.

Stop/run/step a chase etc: *after touch* (\$An pp cc)

Note number (pp) = playback number, from 0 - 19 (decimal)

Aftertouch value (cc) = control codes:

\$00	stop chase
\$01	run chase
\$02	restart from step 1
\$03	fade to next step using programmed fade times
\$04	snap directly to next step

11.5.4 MIDI show control

The following MIDI Show Control messages are supported:

Command	Action
GO	Fire the specified playback or cue
STOP	Pause the specified playback or cue
RESUME	Un-pause the specified playback or cue
LOAD	Set the playback level to full
ALL OFF	Release all playbacks
RESET	Same as ALL OFF
GO OFF	Same as resume

Playbacks/Cues are identified by their User Number. To set the user number, press [Set Legend] then the select button of the cue, then [User Number].

MIDI show control devices are identified by a device ID. To set Titan's device ID go to System mode and select [User Settings], [MIDI]. The default setting is 0.

11.5.5 Audio control (sound to light)

On supported consoles the audio input is divided into frequency bands which can be used to provide the trigger. The [Band] option selects which of the bands is being used.

Audio triggers are adjusted in the Audio Triggers workspace.



If the console does not have suitable hardware a warning message is displayed. Currently only the Quartz and Arena consoles have the audio hardware.

- The Enable switch below the gain slider disables all audio triggers
- The left hand gain slider sets the overall input gain, which can be used to boost weak signals
- Auto gain will automatically adjust the gain, this disables the slider from manual changes
- The Enable switches below each band disable triggers on that particular band
- Trigger level sets the threshold for triggering on each band. The band shows red when triggered.
- The Auto switches on the bands automatically adjust the trigger level on each band when no triggers are occurring.

You can quickly allocate a playback to a trigger by clicking the top Band button above the trigger, then select the playback to be triggered.

On the Arena console, the Audio LED (just above the power switch) will flash when audio is received. Note that the headphone socket on the Arena is linked to the motherboard audio output and can't be used for monitoring the audio trigger input.

11.6 Linking consoles for multi-user or backup

On large shows it is sometimes necessary to have multiple operators programming or running different aspects of the show. The Titan system allows a number of consoles to be connected together to give an integrated system with multiple control surfaces.

In addition, on many shows it is important to have a backup console running in case the main console fails during the show. Titan allows you to run a second console over the network which it keeps synchronised with the main console. Should the worst happen, a single keypress can transfer control to the backup console.

11.6.1 Setting up consoles for multi-user

Titan consoles may be connected to each other for collaborative programming or show operation. Multi-user operation is described in detail in section 2.4 on page 38.

11.6.2 Setting up consoles for backup

Any Titan console can act as backup for any other console, they do not have to be the same model. For example you could run Titan Mobile as backup.

However do plan ahead and think about what parts of your show will become inaccessible if the backup device has less faders/handles than the main console.

-
- 1> *Connect both consoles to the same network and ensure they are set to the same IP range (see section 15 on page 263).*
 - 2> *Press Disk, [TitanNet Sessions], [Backup].*
 - 3> *Consoles available for backup will be listed in the softkeys.*

- 4> *Selecting a console will place that console into backup mode and sync the show to it.*
- 5> *The backup console will show a display indicating the backup status and show name.*

In backup mode the backup console screen displays the current connection and sync status including current show name.

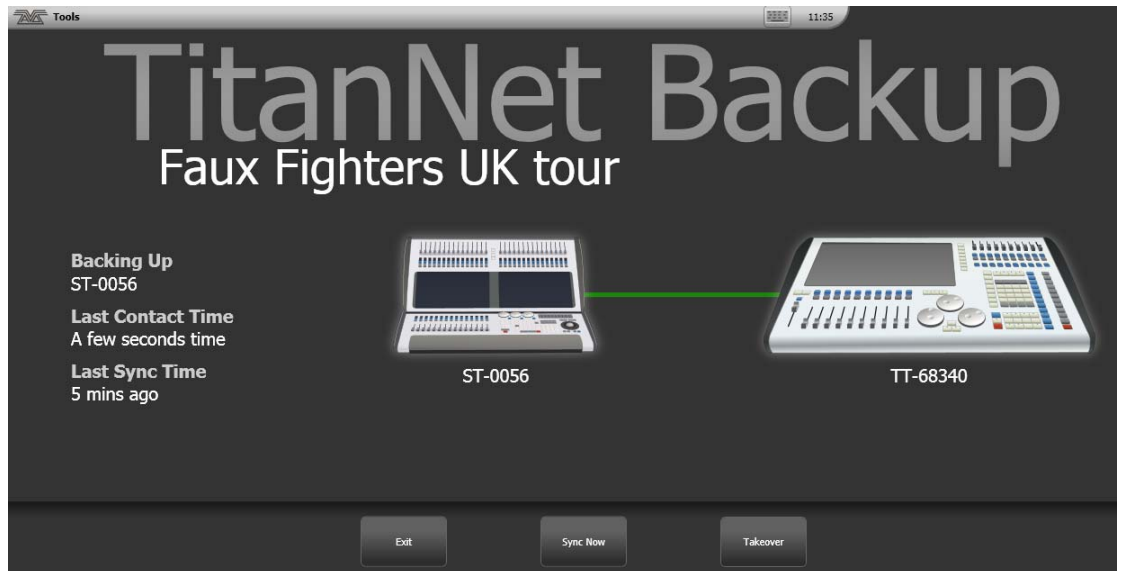

A green line between consoles represents a good connection. If a red line is shown there is a problem with the network connection. A blue line will appear during sync operations.

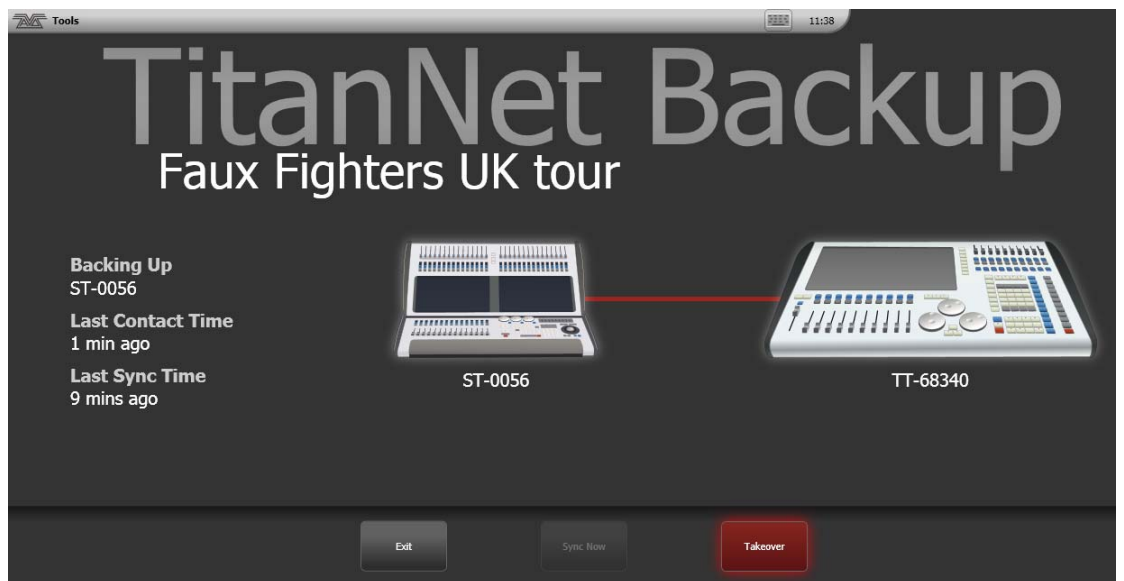

- Shows will automatically sync whenever a show is saved on the main console (including autosave). You can also choose to sync at any time by selecting [Sync Now].
- Pressing [Exit] will abort backup.
- [Takeover] will enable control on the backup console and disable DMX output on the main console. A prompt will appear on the main console to warn that DMX has been disabled. On touch consoles touching on this prompt will open the 'Exit Safe Mode' menu with a softkey option to re-enable output. On the

Pearl Expert you can re-enable DMX output via the shift (Avo) menu.

12. Remote control

With the addition of an external Wireless Access Point, the console can be remote controlled using Wi-Fi from an Android or iOS mobile device such as a smartphone or tablet. This can be invaluable when rigging, testing and focusing. You can also run and store playbacks and palettes from the remote.

You can connect multiple remotes to the console and the console itself remains functional while the remote is connected. Each remote has a separate programmer so an operator can continue to work on the console while another user programs other cues or palettes on the remote.



The remote function operates using the Avolites Remote app on the mobile device. This can be downloaded from the Google Play store or Apple App Store.

12.1 Setting up the remote

All you need to do is make sure that the console is on the same network as your mobile device. The app will automatically detect all the consoles on the network.



Ensure that Wifi security is enabled on the network you are using, as anyone who can connect to the wifi will be able to control the console. You don't want someone in the audience taking over the show.

- You may experience problems with the remote if you have an internet router on the network, as this may route show traffic to the internet rather than between the remote and the console. If the remote does not work properly, disconnect your router from the network.

12.1.1 Using an existing network

If you are connecting to an existing network, DHCP will probably be enabled which will automatically set suitable IP addresses on the console and mobile device. All you should need to do is to plug the console's Ethernet connection into the network.

If the console is set to have a fixed IP address you will need to manually set a suitable IP address for the network – consult the person who manages the network.

12.1.2 Network setup using a dedicated access point

This is a basic setup assuming that the console is connected directly to an access point. For information on setting up your Wireless Access Point please refer to the documentation provided with it.

- We advise using a proper wireless access point rather than a wireless router (ADSL router). Although routers are cheaper, the WiFi connection through to the Ethernet can be flaky. Some routers can be switched to an "access point" mode to avoid this problem.

You need to set up the network settings on the Wireless Access Point, the mobile device and the console so that they can communicate with each other. In this example we use an Android smartphone but other devices are similar.

- 1> *In the access point's admin screen, give the access point an IP address such as 10.0.0.1, make sure wireless is switched on and enable the DHCP server. Take note of the name of the wireless network (SSID).*
- 2> *Connect an Ethernet cable from the back of the console to the access point.*
- 3> *Set the IP address of the console: Switch to System, select [Network Settings], press [Local Area Connection], then press [Set IP 10.*.*.*].*
- 4> *On the mobile device, go to WiFi settings or Network Settings and ensure Wi-Fi is set to on.*
- 5> *Select the wireless network from the list, the name you took note of earlier. The mobile device should automatically get an IP address from the access point.*
- 6> *Run the Titan Remote app. You should see the console listed.*



If you are using the remote at showtime, on the Access Point you should select the option to hide the SSID. If you do not do this, every smartphone in the audience will find your wifi and try to connect to your Access Point which will make the remote operation very sluggish.

12.2 Operating the remote

To connect to the console, open the Titan Remote app and a list of available consoles will be shown - hopefully if you have done the network setup correctly, you will see your console listed.

There is also a local emulator which can be used to test or demonstrate the remote when no real console is connected.

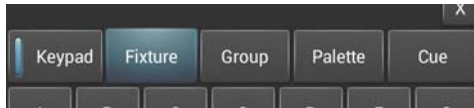

Choose what you want to control using the row of buttons across the middle of the app. The Keypad button enables or disables the numeric pad (the keypad overlays all the other screens, so you will need to turn it off to see the others).

12.2.1 Keypad

The keypad screen lets you do most common tasks in the way a programmer's remote normally works. You can turn on/Locate fixtures and dimmers either singly or together.

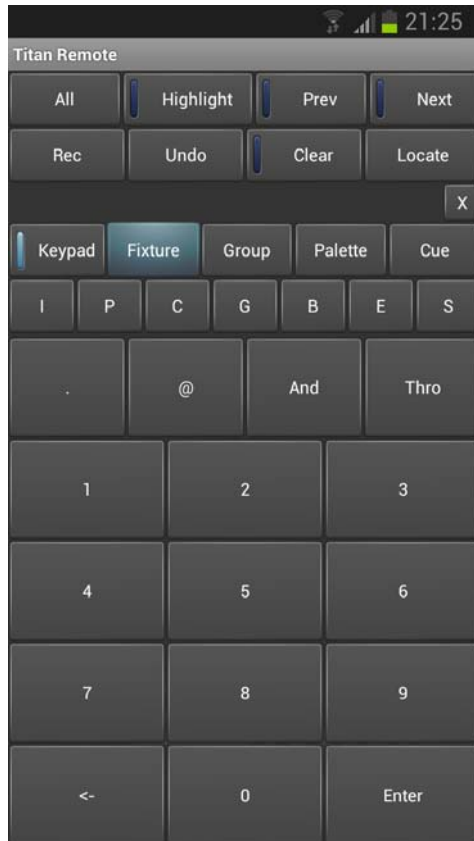

The User Number of the fixture or dimmer is used for control. For example to turn on dimmer 3 at 50% you would press:

3@5

To turn on dimmers 1-10 at 80% you would press:

1 Thro 10 @ 8

For 100% you just press @ twice, for example

1 Thro 10 @ @

To locate one or more fixtures, press Locate instead of the @ button. You can select multiple ranges of dimmers or fixtures using the And button, for example *1 Thro 10 And 20 Thro 30 @ 6*.

12.2.2 Controlling fixtures

The fixture screen allows you to select fixtures exactly as you would on the console.



You can then use the Palette screens to control the fixtures, or press the IPCGBES buttons to directly control functions of the fixtures using wheels.

You can scroll the fixture screen up and down by dragging the window. To view the fixture pages, drag the Pages bar to the right.

Press the All button to select all fixtures. Hold down the All button to step through various selection patterns (odd, even etc).

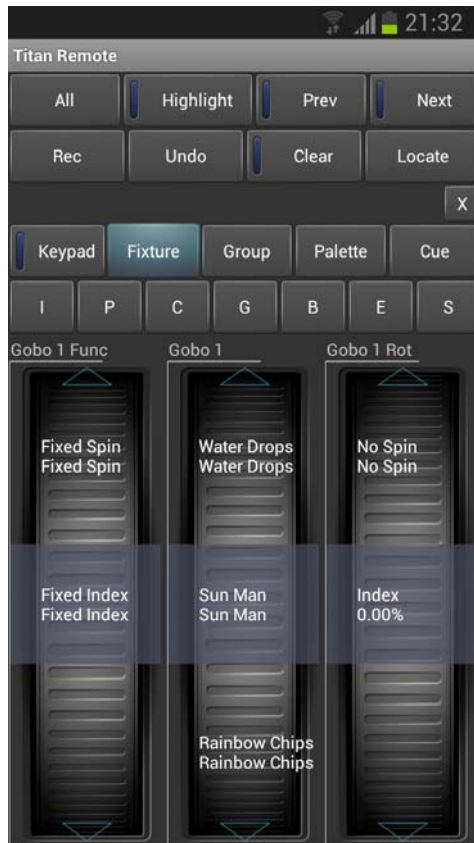

The wheels show function values (such as colours or gobo names). To go to the next function, just touch the arrows at the top or bottom of the wheel. To manually scroll the value, spin the wheel with your fingers. If there are more than three functions, touch the IPCGBES button again to change to the other functions.

Press the Clear button to clear the selection and all changes in the remote programmer. Hold down the clear button to clear all programmers (for example if someone has been doing something on the console at the same time, this will clear the console's programmer too).

You can also play back cues using the Cue screen. Hold down a playback button to kill or release an active playback.



If you update the legends of palettes or cues on the console while the remote is running, the legends on the remote will not be updated. Exit and restart the remote app to show legend changes made on the console.

12.2.3 Recording groups and palettes

You can record groups and palettes using the Rec button on the remote, then click a workspace button as normal. You can also hold down an empty button to quick record a group or palette.

If you hold down a used palette button, the current programmer will be quick merged into the existing palette.

You cannot record cues using the remote.

13. User Settings and other options

The console has a large number of options to help you set it up just the way you like it. Commonly used options can be set from the User Settings menu which is available on a softkey when you hold down the Avo button.

In this chapter there is also information on how to upgrade the application software.

13.1 The System menu

The System menu is accessed by holding Avo and pressing Disk. Some consoles are also fitted with a key switch or mode switch to select System mode.

The options in this menu are separated from the other options on the console because you would normally only change them occasionally, or because they can have serious effects on the way the console works and you wouldn't want to change them accidentally.



When the console is in System mode, playback control, preset controls and programming buttons are all disabled.

13.1.1 TitanNet Security

This option sets how the console communicates with other Titan devices as a backup console. See section 11.6 for information about backup.

13.1.2 Network Settings

This option sets up networking (Ethernet) parameters for the console. See section 15 for details.

13.1.3 User Settings

The User Settings menu may also be accessed from Program mode: hold down the Avo Shift button and press [User Settings]. See section 13.5.

13.1.4 Key Profiles

Allows you to modify the functions of some buttons. See section 13.3.

13.1.5 Wipe

The Wipe menu erases the current show. This is the same as the [New Show] option on the Disk menu, but is provided here for old fashioned Avolites users who are used to it being on the System menu.

The [Wipe Visualiser Patch] option will erase all fixtures from the visualiser without affecting the current show.

13.1.6 DMX settings

Allows you to configure how the console outputs DMX. This option is described in detail in the next section 13.6.

13.1.7 DMX Merge Settings

Allows you to select how DMX will be output across multiple consoles or processing nodes. See section 13.6.3.

13.1.8 Triggers

Sets up the console for external triggering such as MIDI or DMX-in. This option is described in detail in section 11.5 on page 219.

13.1.9 Display Setup

This option gives you a menu for enabling and disabling external monitor(s). If you don't have a monitor connected, set this option to "Disabled" to improve the performance of the console.

13.1.10 Assign mastering

This option allows you to assign any playback fader to be a master fader. Various different types of master fader may be assigned. See section 11.1.3 on page 211 for more information.

13.2 Configuring workspaces

The main area of the touch screen(s) can show a configurable arrangement of workspace windows. Workspaces can be saved to a touch button and called back immediately.

Some windows have associated commands called a Context Menu. These are shown in the "context buttons" area on the right of the screen or on some consoles by pressing the Context Menu button at the top right of each window.

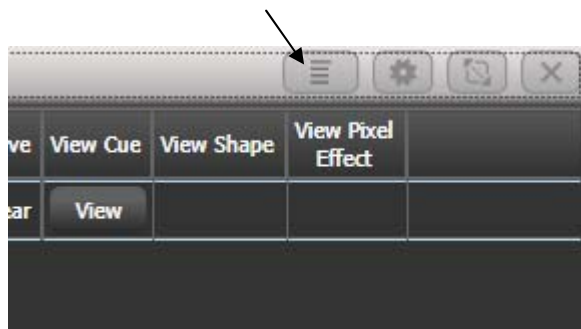

13.2.1 Opening workspace windows

You select which workspace windows you want to see using the [Open Workspace Window] menu command on the root menu or the View menu, or by using a View shortcut (see 2.3.1 on page 26 for a list).

13.2.2 Selecting and positioning workspace windows

Windows can be freely sized and positioned, or you can use one of the standard size/position settings.

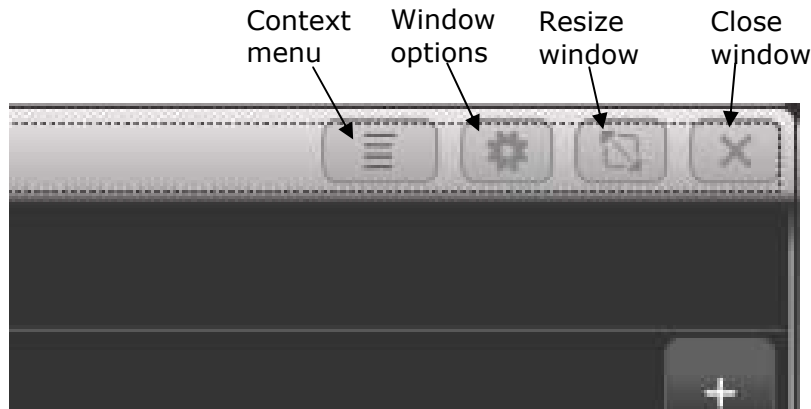

For adjustable sizing, click the Window Layout button at the top of the window. A grid screen will open.



With the softkey [Edit All Windows] set to Off, you just set the size of the selected window.

Touch and drag the top left or bottom right corners to resize the window. Touch and drag anywhere else to move the window.

Tap on a corner to set a start corner position – the window will highlight in red and ask you to tap to set the opposite corner position.

If the softkey [Resize Neighbours] is set to On, surrounding windows will resize to make room for the window you are editing. If Off, the other windows will stay the same size and go behind the current window.

If [Edit All Windows] is set to On, corner arrows will appear in all windows and you can adjust the size of all the windows together. Press Enter, Exit or [OK] to finish.

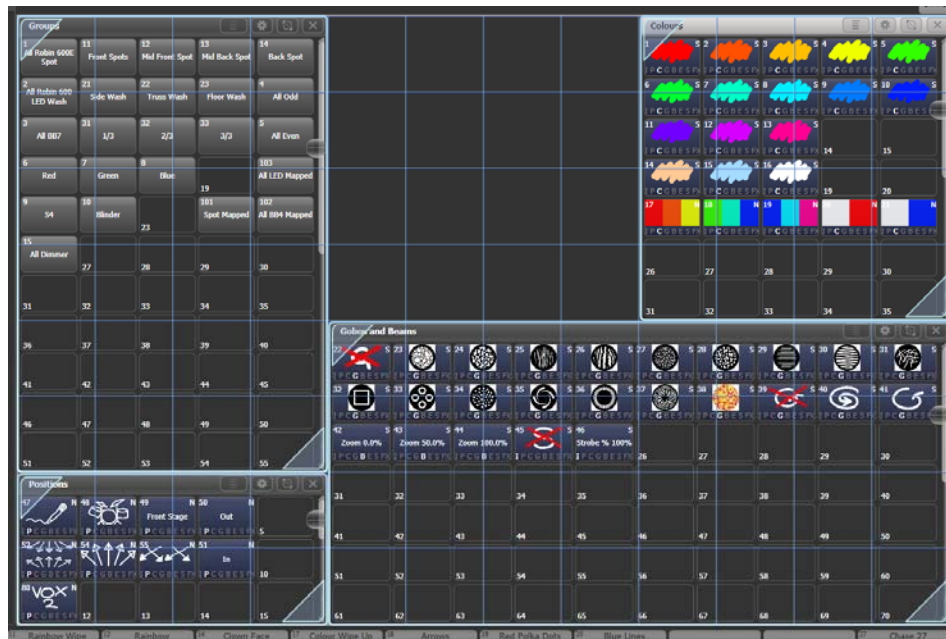

To set one of the standard sizes, open the Window Appearance menu using the Cog button at the top of the screen. Some consoles also have hardware buttons for Min/Max (toggle the window between full and quarter size) and Size/Position (move the window around the possible positions and screens).

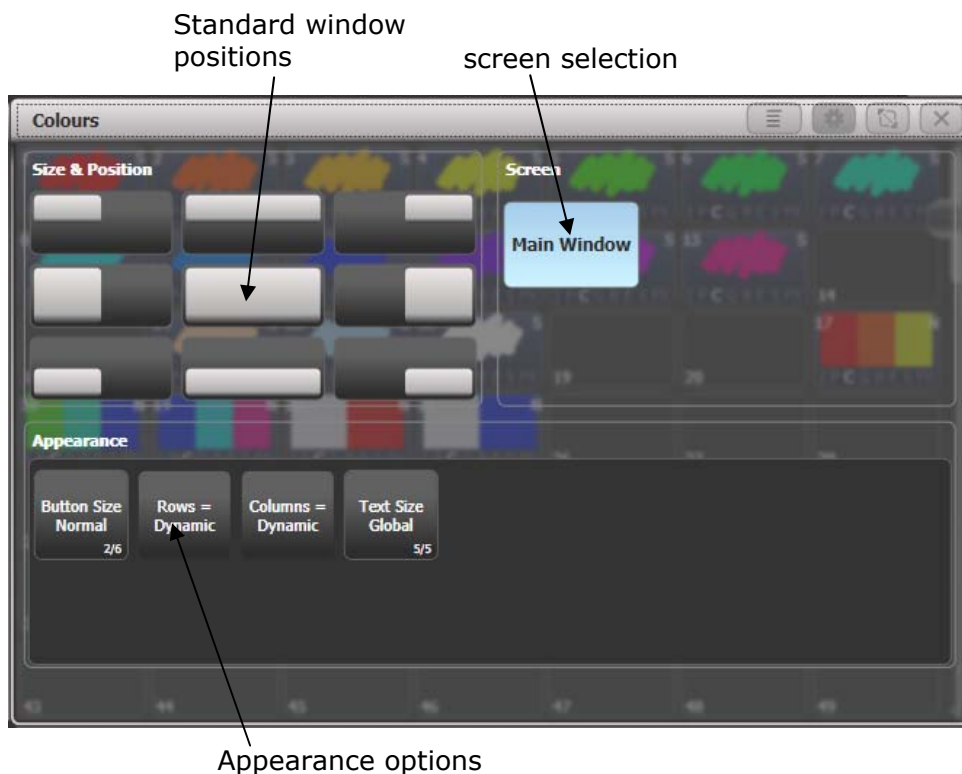

Some possible standard window sizes/positions are shown below.



Quarter size



Double wide



Double height



Maximised



If you accidentally set a window to a single grid size, you can't then get to the Window Layout button to resize it. Select the window and use the [Min/Max] softkey to set the window to a fixed size.

You can move the active window between screens from the Window Appearance screen, or by pressing View then [Window Options] then [Move Screen], or hold Avo and the Size & Position button.

You can close the active window using the Close button. You can close all windows by pressing Avo+Close, or use the [Close All] softkey.

13.2.3 Controlling button layout

Buttons normally resize automatically to suit the screen size and resolution, however this means that moving shows between different consoles can make the number of rows and columns change, causing buttons to move around. If you have set a particular layout you want to keep (for example positioning fixtures to match the layout on stage), open the Window Appearance menu using the Cog button and set Button Size to [Button Size Set Rows & Columns]. You can then set a fixed layout using the [Rows] and [Columns] buttons.

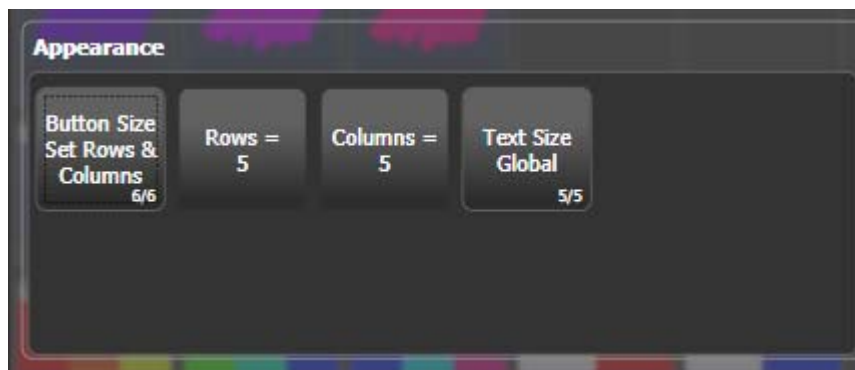

The Rows and Columns settings are remembered even if you change the button size to one of the automatic sizes, which allows you to swap between auto and fixed modes.

13.2.4 Saving workspaces

You can save different workspace setups to the Workspaces touch buttons (to the left of the menu) by pressing Window Open then [Record Workspace], then touching one of the Workspaces buttons. This button will then reconfigure the entire workspace with a single touch. You can also save workspaces onto any grey handle or macro button.

Workspaces are saved with the show.

As an example of setting up a workspace, suppose while programming you wanted to be able to access fixtures, position palettes, fixture attributes and shapes:

- 1> Press Exit to get to the root menu then the [Open Workspace Window] menu softkey.
- 2> Find the [Fixtures] window in the list and press it.
- 3> If the window is not in the top left quarter, press the Size & Position button (above the numeric keys) until the window occupies the top left quarter.
- 4> Press [Open Workspace Window] again and select the [Positions] window. Press the Size & Position button to position it in the desired location.
- 5> Repeat to activate the [Attribute Control] and [Shapes] windows.
- 6> Press Window Open (to the right of the numeric keys) then [Record Workspace], or hold Avo and press Window Open. Type in a name for the workspace. Then touch the Workspace button where you want to store this workspace layout. Or, you can use Quick Record – just touch an empty workspace button and it will turn red with a +. Type a name for the workspace and touch again to store it.

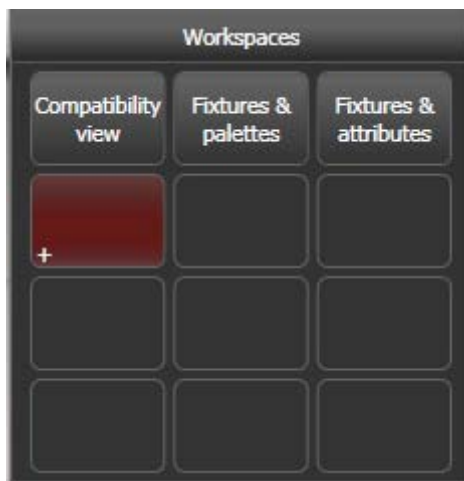

- [Record Visible/All Windows] lets you set whether the workspace will contain only the windows which are currently visible, or will also include any windows which are hidden underneath other windows.
- [Remove/Leave other windows on recall] sets whether all other windows will be closed when this workspace is recalled.
- To delete a workspace button, press Window Open, Delete, then the workspace button to be deleted.

13.2.5 Compatibility windows for Pearl Expert shows

The "Fixtures and Playbacks" and "Groups and Palettes" windows allow you to access the preset fader handles in shows which have been programmed on the Pearl Expert.

When either of these windows is opened, there is a context button option to [Move to workspace]. This will move the handles from the

compatibility window to the appropriate workspace window. You need to do this twice, once with the "Fixtures and playbacks" window selected, and once with the "Palettes and groups" window selected.

13.2.6 Configuring an external monitor

For extra workspace you can connect an external monitor to the DVI port on the console.

The external monitor is disabled by default and will show a 'disabled' message. To enable, switch to System mode and select [Display Setup] then press [External Display Disconnected]. The option will change to [External Display Connected] and the display will be enabled.

For best performance of the console, disable monitor outputs you aren't using.

If you need to change the monitor resolution or settings, click 'Tools' at the very top of the touch screen and select 'Control Panel', then 'External Monitor', then select the option to match the resolution of your monitor.



Troubleshooting

If you cannot see anything on any screen, there are some keyboard shortcuts that should in most cases reset all the screens back to their correct settings. You will need to connect an external keyboard (standard PC type) to activate these.

Ctrl+Shift+Alt+Esc reset to factory default settings (1024x768 for external monitor)

Ctrl+Shift+Alt+F1 (600x800 for external monitor)

Ctrl+Shift+Alt+F2 (1024x768 for external monitor)

Ctrl+Shift+Alt+F3 (1280x1024 for external monitor)

Ctrl+Shift+Alt+F4 (1600x1200 for external monitor)

All of the above will reset the touch screen to the required resolution. The first shortcut is the preferred choice, however none of these should be used unless it's necessary (using the menu or Display Setting where possible). Once any of these keyboard shortcuts has been used, power off and restart the console to complete the changes.

If the console software is running, you may have to press Esc to unlock the keyboard before the shortcuts will work.

If none of the above works, the second solution is reinstall the graphics drivers.

1. Press F8 on start up and enable VGA MODE (use an external keyboard, or the Zoom/Focus/Iris attribute button is also mapped to F8 – see section 1.1.1).
2. In Tools, Folder Options, View - enable Show hidden files and folders.
3. In Control panel, System, Hardware, Device Manager, Display Adapters - right click on 945GME and update driver.
4. Select the driver to install as C:\Windows\Inf\iegd.inf.

13.3 Show Library window

The Show Library window collects all the information about your show into a single place. It is mainly used to transfer programming when importing between different shows, but can also be used to move items around within your show.

13.3.1 Show Library tab

The Show Library lists all programmed elements of your show including fixture patch, fixture groups, palettes, playbacks, macros and workspaces. Use the buttons down the left hand side to filter what types of information are displayed.

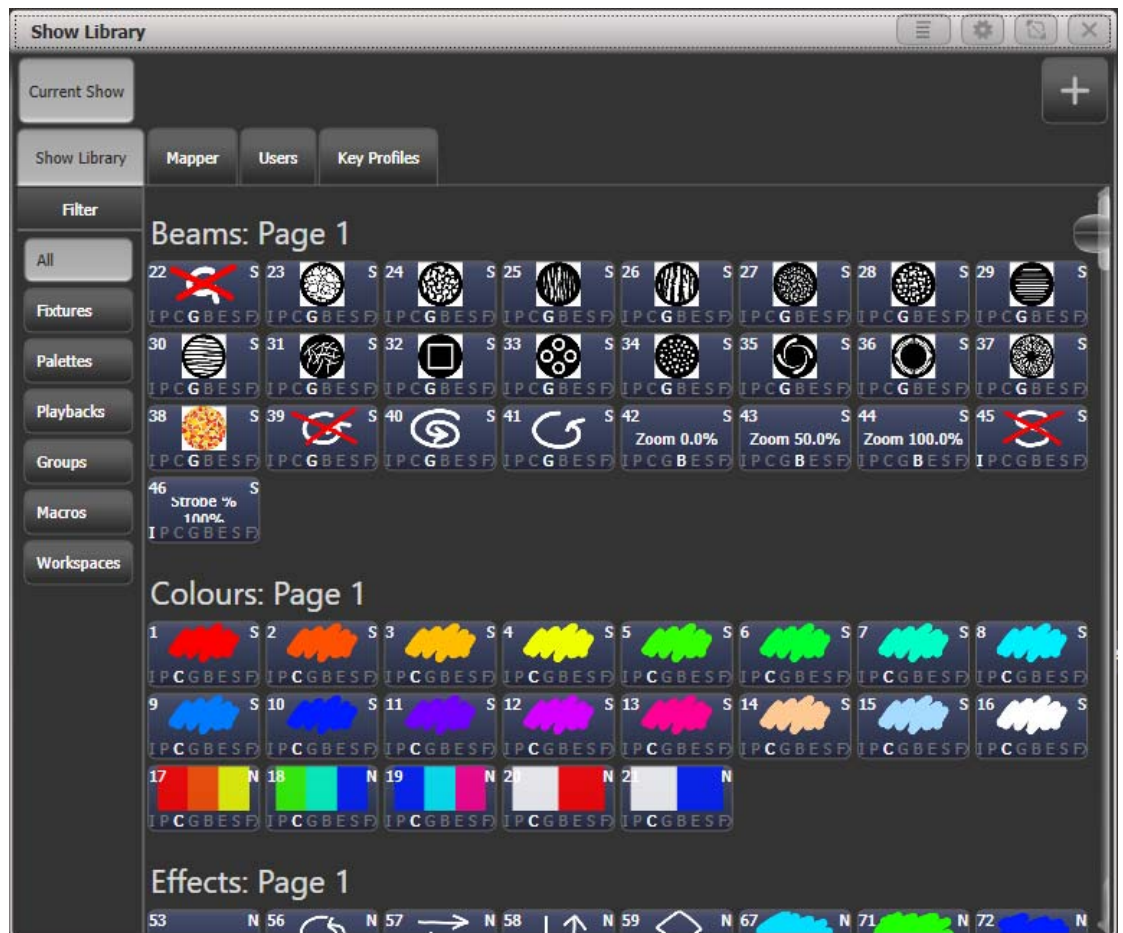

Clicking on the buttons in the Show Library window will activate them.

13.3.2 Mapping shows for import

Press the Plus button top right to map another showfile to allow you to import elements of it.

Using the Mapper tab you can map similar fixtures from an imported show to the current show. This lets you load in your favourite programming from other shows. See section 2.6.3 on page 44 for more details.

13.3.3 Users tab

This tab allows you to set up and select users for the console. This is the same as the [Users] option found in the Disk menu.

13.3.4 Key profiles display

Selecting the Key Profiles tab shows all information about the different Key Profiles available on the console. The available profiles are listed down the left hand side, and the key allocations are shown on the right. Key Profiles are described in the next chapter.

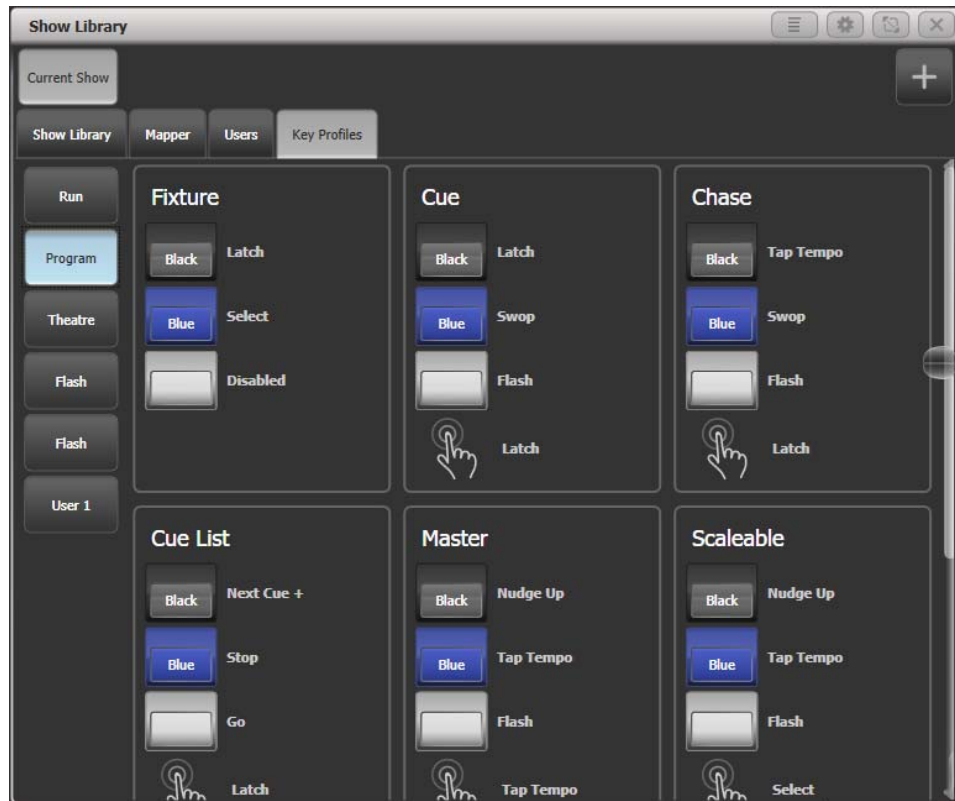

13.4 Key Profiles

The console allows you to reconfigure how the front panel buttons work to suit your method of working. You can save your settings as a Key Profile. Different profiles can be selected for different users or to enhance the operation of the console for a particular use.

There are standard Key Profiles for Run mode, Takeover Run mode, Program mode and Theatre mode. These standard profiles cannot be edited, so you always know how they will behave. You can create your own editable profiles using one of the standard profiles as a starting point.

The current settings of the playback buttons are shown on the screen related to each playback fader.



13.4.1 Creating and editing key profiles

To create or edit a profile, switch to System mode then select [Key Profiles]. You can then use the Manage Profiles menu to View, Edit, Add, Delete or Rename profiles.

Key Profiles can also be viewed from the Show Library window as described in the previous chapter.

When Adding a new profile, you can select an existing profile to copy settings from.

You can also edit Key Profiles from Program mode by holding Avo, then selecting [Edit Current Key Profile]. If the current key profile is

one of the non-editable system ones, you are prompted to add a new profile or select an existing editable profile.

The current settings for the [blue], [grey] and (where available), [touch] buttons are shown on the left side of the screen.



The groups of keys you can set are as follows. The blue or grey fixture/palette buttons only exist on the Pearl Expert, on other consoles these settings will not do anything.

Fixtures: the blue, grey or touch key can be allocated to Disabled, Select, Flash, Swop, Latch. The "Latch" function is equivalent to putting the fader to full for that fixture and touching again returns the fader to 0.

Palettes: the palette (grey) key can be allocated to Disabled or Select Palette. You can select if the palette function takes precedence over the flash function (if a handle has both palette and flash functions) or vice versa.

Groups: the group (grey) key can be allocated to Disabled, Select Group. You can select if the group function takes precedence over the flash function (if a handle has both group and flash functions) or vice versa.

Cues: the blue or grey key can be allocated to Disabled, Flash, Swop, Latch, Preload, Go.

Chases: the blue or grey key can be allocated to Disabled, Flash, Swop, Latch, Go, Stop, Preload, Connect, Tap Tempo.

Cue Lists: the blue or grey key can be allocated to Disabled, Flash, Swop, Go, Go Back, Stop, Preload, Connect, Next Cue +, Next Cue -, Review Live Cue, Cut Next Cue To Live, Snap Back, Release.

Macros: can be set to Select or Prefer Macro (the Macro function will take precedence over other functions stored on the button).

Quick Record: allows you to disable the quick record function.

13.4.2 Selecting a Key Profile

13.4.3 Individual Key profiles for playbacks

Each playback can have an individual Key Profile allocated to it. This allows you to customise the panel button functions differently for each playback. The Key Profile for the playback is selected using the [Key Profile] option on the Playback Options menu (softkey B on the main program menu). If the playback Key Profile is set to "None", the default global profile is used.

13.5 User Settings

The User Settings menu may also be accessed from Program mode: hold down the Avo Shift button and press [User Settings].

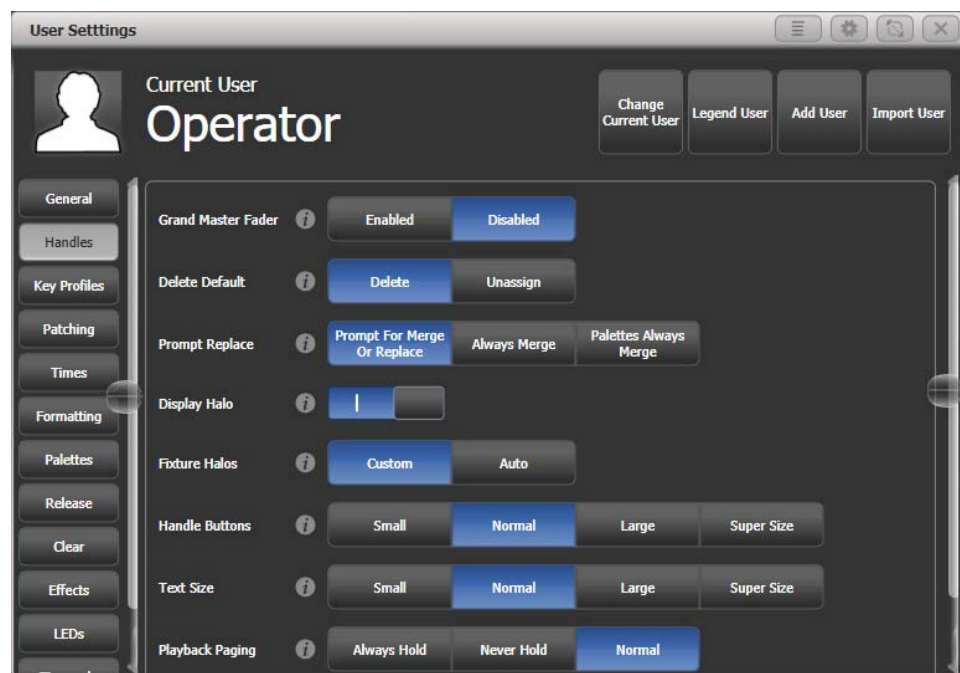

A window will open showing the user settings, or you can also set the same options using the softkey options. User Settings are individual for each User and you can change the User from this screen.

Click on the  button for a help window on each setting.

Options are divided into categories on the softkeys or down the left hand side.

13.5.1 General

Chase Snap: If enabled the Next Step and Prev Step buttons will snap to the new state. If disabled, programmed fades will be shown. This is the same function as the Snap button which features on some consoles.

Cue List Snap: If enabled the Next Step and Prev Step buttons will snap to the new state. If disabled, programmed fades will be shown.

Clear Record Mask: sets whether the record mask is cleared back to All Enabled when you enter the Record function, or whether it remains as you previously set it.

Copy Cues: sets whether tracked values will copy when you copy a cue from a tracked cue list.

13.5.2 Handles

Grand Master Fader: sets whether the Grand Master fader is enabled or disabled (some consoles do not have this fader). This can be handy if it gets broken or if you wish to disable it to avoid confusing inexperienced operators. The default setting is 'Disabled'.

Delete Default: sets whether items are deleted when you press Delete and double tap them, or whether they are released from the handle and become unassigned. Unassigned items can be reused from the Show Library.

Prompt Replace: sets the console action when you try to save to a handle or playback which is already used.

[Prompt for Merge or Replace] - the console will always prompt

[Always Merge] - the console will never prompt

[Palettes Always Merge] - the console will prompt unless you are saving a palette.

Display Halo: Allows you to turn off all coloured halos on buttons.

Fixture Halos: Sets how coloured halos are displayed on fixture buttons.

[Custom] - Only user defined halo colours are shown.

[Auto] - Fixture buttons are coloured using automatic fixture colours

Handle Buttons: sets the default size of the touch buttons to [Small], [Normal], [Large] or [Super Size]. This can be overridden separately in any window.

Text Size: sets the default size of the text used in touch buttons. Can be overridden in any window.

Playback Paging: [Playback paging] sets how the playback faders behave when you change page with a playback active.

[Normal] - sets the normal mode for the console type.

[Always Hold] - sets the standard behaviour for non-motorised faders where the fader keeps control of the active playback when the page is changed and has to be lowered to zero before a playback on the new page can be fired.

[Never Hold] - the standard behaviour for motorised faders where the fader always relates to the current page. To regain control of a playback from another page you have to go back to that page and level match the fader. When a playback is active from another page the display area goes purple and the page number is shown at the top in light blue.

Current Handle World: Sets the handle world. See 2.4.2.

13.5.3 Key Profiles

Allows you to select and edit key profiles using the softkeys. See 13.3.

13.5.4 Patching

Warn Before Parking Fixtures: sets the console action when you patch a fixture which overwrites the DMX channels of another fixture. This causes the overwritten fixture to be "parked".

[Always] - console will warn you.

[Never] - console will park the fixture without warning you.

DMX Address: sets whether the DMX address of fixtures is shown in the fixture touch buttons.

Auto Groups: sets whether the console will automatically create new groups for fixtures when you patch.

Preset Palettes: sets whether preset palettes should be created when fixtures are patched.

[Do Not Create] – no palettes will be created.

[Create On Workspaces] – palettes will be created in workspace windows.

[Create On Presets] – palettes will be created on preset buttons.

13.5.5 Times

Tempo Units: sets the units for displaying tempo. The options are [Beats per Minute] or [Seconds].

Connected View Sets: sets the console action when you change the speed of a connected chase. [Connected View Sets Temporary Chase Speed] means that the console will not save the modified speed, and the next time the chase is fired it will go back to its programmed speed. [Connected View Sets Chase Speed] means that the console will modify the saved speed of the chase.

Preload Time: sets a fade time for the Preload function, normally 2 seconds. This value would normally be set for quiet fixture movement.

Times Format: selects between HH:MM:SS format and Seconds format. In HH:MM:SS format the console will convert any number you enter into hours minutes and seconds.

13.5.6 Formatting

Channel Levels: sets how you enter channel levels when using numeric entry of levels.

[Channel Levels Set In Tens] - enter one digit for the channel level (e.g. 5 = 50%).

[Channel Levels Set in Units] - enter two digits, i.e. 50 = 50%.

Number Style: sets how channel values are displayed in Cue View and Palette View.

[Precise] - will include all decimal places.

[Rounded] - round to nearest whole number.

[Dynamic] - show decimals where appropriate, remove trailing zeros.

13.5.7 Palettes

Quick Palettes: enables or disables the Quick Palette function. See section 5.2.3.

Minimum Palette Mode: Sets whether global or shared palettes will be created when recording palettes.

Add New Palette Channels: sets whether new channels added into palettes will be added to playbacks using those palettes.

Auto Legend: sets whether new items will automatically have legends generated for them (colour scribbles for colours or descriptive legends for other functions).

Highlight Active Palettes: sets whether active palettes are shown as highlighted in the workspace windows.

Filter Relevant Palettes: sets whether palettes which do not apply to the selected fixtures will be greyed out.

Master Palette Time: Sets the default fade time to be used when recalling palettes live. See 11.1.11.

Master Palette Overlap: Sets the default overlap to be used when fading palettes.

Record Nested Palettes: If enabled, palettes containing other source palettes will be updated when you change the source palette.

Preset Palettes: This is the same as the option in the Patching section, see above.

13.5.8 Release

These settings can also be changed from the Release menu.

Release To Home: If enabled, when the last playback is released fixtures will return to home values. If disabled, LTP channels will remain set.

Master Release Time: Sets the default release time.

13.5.9 Clear

These settings can also be changed from the Clear menu.

Auto Reset Mask: When enabled, the Clear Mask will reset to include all attributes after every clear.

Zero Preset Fader Levels: When enabled, intensity levels set on fixtures patched to fader handles will be zeroed when Clear is pressed. If disabled the levels will remain set but will be removed from the programmer.

Release to Playback Values: If enabled, LTP channels will release to the values set in the last playback when Clear is pressed. If disabled, LTP channels will not change when Clear is pressed.

Clear Cue Times: If enabled, resets cue times in the programmer to defaults when Clear is pressed. If disabled, cue times set in the programmer will remain.

13.5.10 Effects

Swop Shapes: Sets how shapes react to Swop mode.

[All Shapes] – All running shapes from other playbacks are stopped

[Intensity Shapes] – Only intensity shapes from other playbacks stop

Shape Behaviour: sets whether Key frame shapes will overlay all other values or will work in LTP mode where later changes will override the shape. See page 6.2.3.

13.5.11 LEDs

Fixture LEDs: Sets how the button LED behaves when a fixture is patched to a fader handle.

[Show Occupation] – the LED shows handle empty and selection state

[Mimic Intensity] – the LED shows fixture intensity level.

The options below only function when [Show Occupation] is selected.

LED Empty Level: Sets level for unpatched handle.

LED Occupied Level: Sets level for occupied but unselected handle.

LED Programmer Level: Level if fixture is in the programmer.

LED Selected Level: Level if fixture is selected.

13.5.12 Timecode

Kill Out of Range Playbacks:

MIDI Device ID: Sets the Device ID when using MIDI show control commands.

MIDI Glitch Detection: Enables the glitch options below.

MIDI Glitch Tolerance: Sets the maximum amount of time a MIDI timecode can jump by without being seen as a glitch.

MIDI Glitch Timeout: Sets the amount of time the console should ignore MIDI timecode for after a glitch has been detected.

13.5.13 Wheels

Wheel Sensitivity: The sensitivity of the encoder wheels, and the pan/tilt threshold settings can be adjusted using this option. Wheel sensitivity is adjusted using Wheel A and the current level is shown on the display.

Pan & Tilt Threshold: Enables or disables the pan/tilt threshold options below.

Pan Threshold: Sets the sensitivity of the Pan control if above option enabled. Larger numbers make Pan work slower.

Tilt Threshold: Sets the sensitivity of the Tilt control if above option enabled. Larger numbers make Tilt work slower.

Auto Connect: sets whether Chases and Cue Lists will auto-connect to the wheels when the playback is fired. The options are [Off], [Chases], [Lists] and [Chases and Lists].

Press and Hold Fan: [Press and Hold Fan] changes the Fan function so that it only works while the Fan button is held. This avoids the common user error of leaving Fan turned on accidentally.

13.6 DMX output mapping

There are various ways to connect fixtures to the console. As well as the XLR sockets on the console, you can connect fixtures using Ethernet and wireless links.

The console itself can output up to 12 universes of DMX. "Pro" versions of consoles can output 16 universes. Titan One outputs one single universe.

If you need to output more universes, it is recommended to network the console to one or more Avolites TitanNet processing nodes. This off-loads the DMX processing, allowing the console to control up to 64 universes of DMX in total.

- The software will allow you to configure more than 12 universes from a single console but performance of the console will be degraded. A warning will be shown in the processing load section of the TitanNet overview.

13.6.1 Configuring DMX outputs

Switch the console to System mode and select [DMX Settings] on the second page of options.

The screen will initially show the node tab relating to the console itself. It shows a list of available DMX *nodes* (places where you can send the DMX to) on the left, and a list of the 12 available DMX *lines* (outputs generated by the console) on the right. Each DMX line can send data to one or more nodes. If you assign more than one node to a line, those nodes receive duplicated data.

On the right hand side, under each DMX Line there is a list of which nodes are linked to that line. The default setting is for DMX Lines 1-4 to be linked to DMX Nodes Output A-D, the four XLR sockets on the console (on consoles with eight XLR sockets, the first 8 lines are linked).

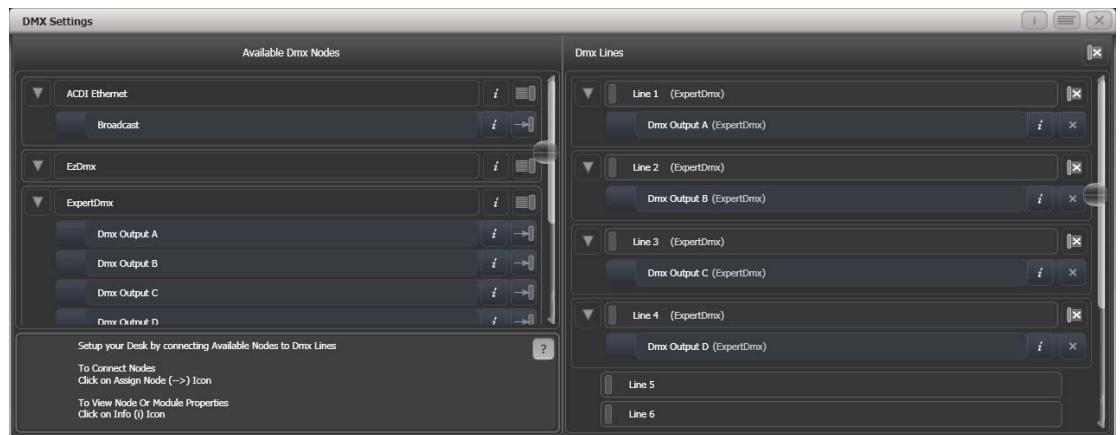

You can individually assign Nodes to Lines using the arrow button, or assign all Nodes of the same type using the group assign button. For example, to assign each XLR output socket on the back of the console to a DMX line, you would click on the Group Assign button of the ExpertDMX nodes.



To assign a node to a line, click on the arrow on the node (the node will be highlighted), then click the line you want to assign to it.

To delete a node from the DMX lines, click on the X button. To delete all nodes from a line, click on the Group delete button

You can show information about the DMX nodes, or the DMX lines, by clicking the i button. For Ethernet/network type nodes, this allows you to set detailed properties such as IP address ranges and net masks.

Group delete Individual delete



If you have further networked DMX processing nodes connected, these can be individually configured using the tabs across the top of the screen.

13.6.2 TitanNet Overview

If you select the TitanNet Overview tab at the top of the screen, you can see all the DMX nodes which are connected and which output lines they are allocated to.



The left side of the screen shows the 64 possible DMX output lines on the console. To the right of this are the processing nodes which are connected, the top one being the console itself. Each node shows how the lines are allocated to the physical outputs on the device. Clicking this area will open the detail tab for the node.

Clicking any one of the nodes will show detailed information about that node on the right, including the IP address, number of available processing slots, number of lines assigned, status of the connection with the node, and the processing load of the device. If more lines are assigned than the maximum number of slots, a warning will be displayed.

If a show is loaded that had fixtures and lines assigned to processing nodes which are no longer found on the TitanNet network, a screen will appear listing nodes in use and available nodes, giving you the option to reassign the lines.

13.6.3 DMX merge

The DMX merge window allows you to set up where DMX will be output in a system where you have multiple consoles or processing nodes connected.

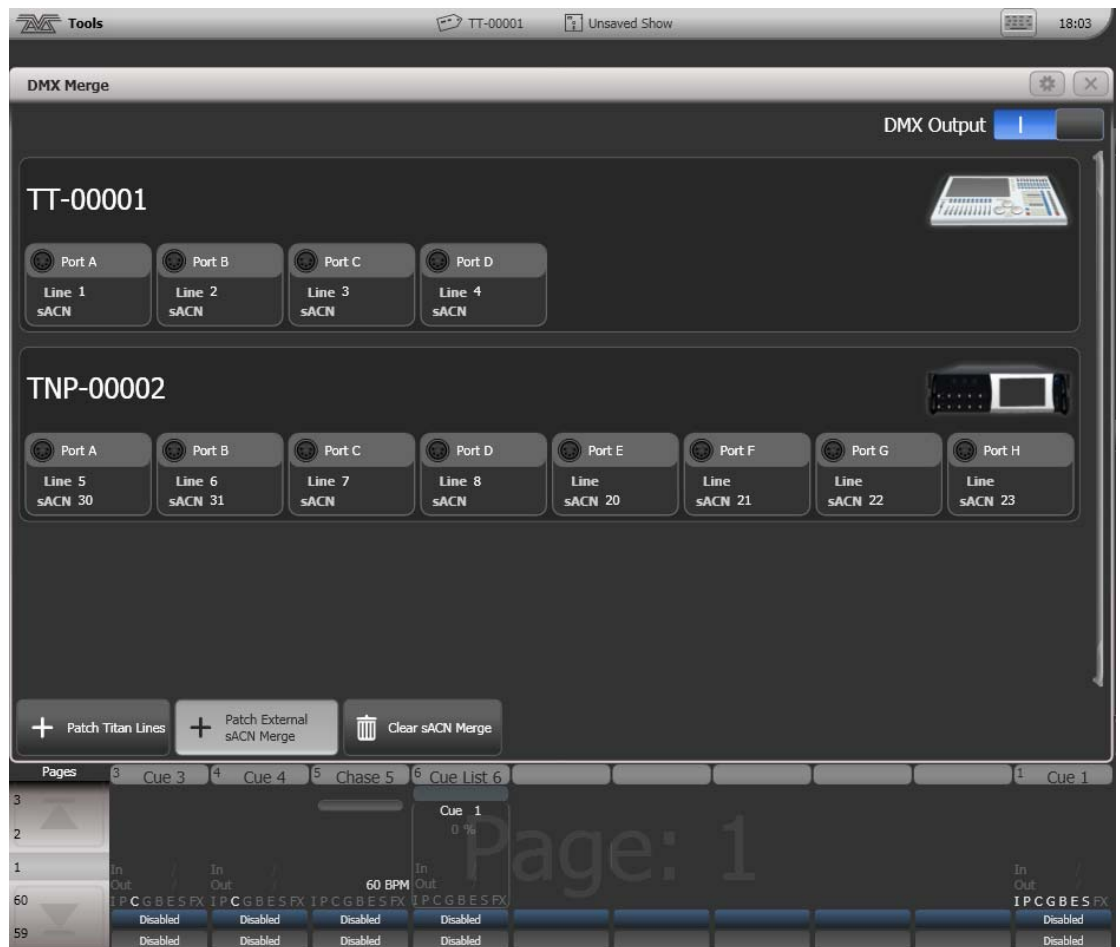

To configure an output port, click on Patch Titan Lines, enter universe number then click on a port to assign.

To remove an assignment, click on Clear sACN Merge then select a port.

The DMX Output switch can be used to disable all DMX output.

13.7 Curves

The console provides a variety of curves which set how the console tracks fades in playbacks; either the same speed all the way (linear), or starting and ending gently but faster in the middle, and various other options. Curves are used in various places in the console, one example is in the [Playback Options] menu (see section Playback options on page 166).

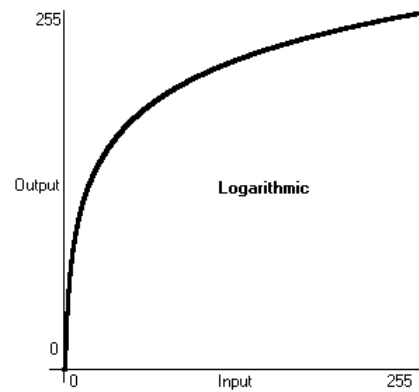
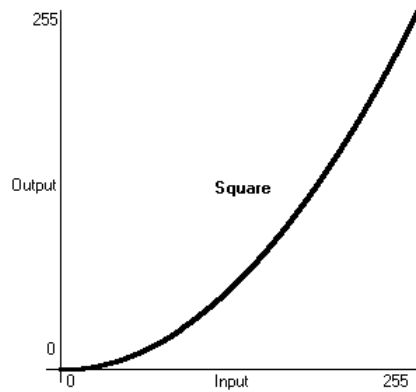
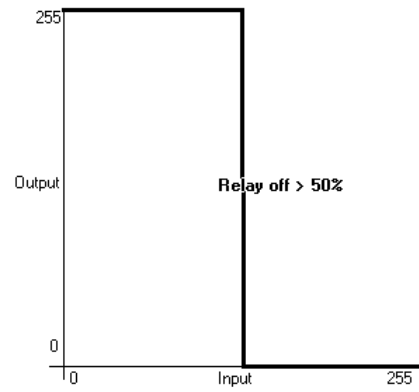
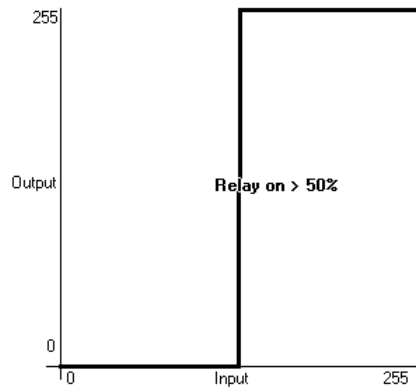
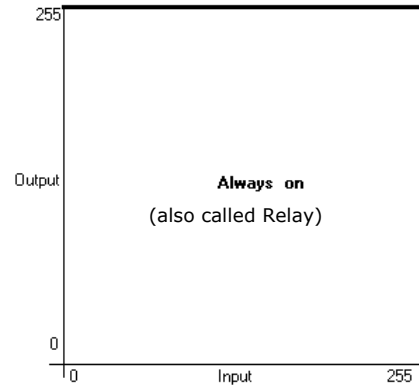
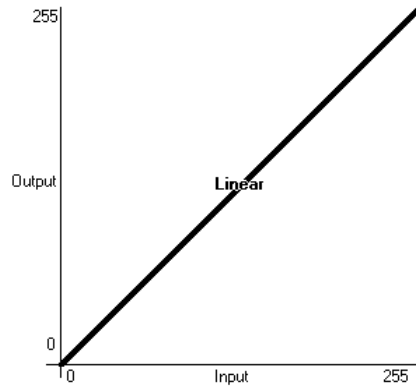

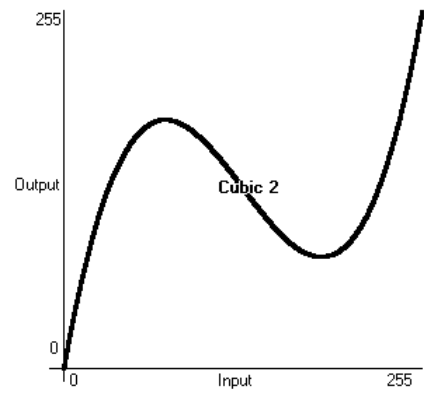
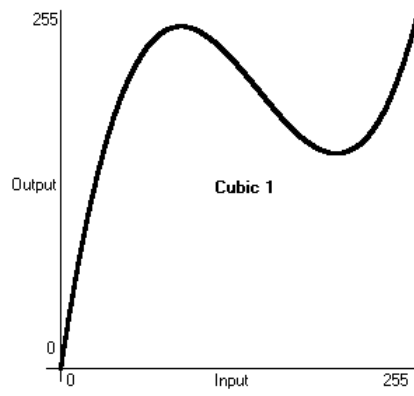
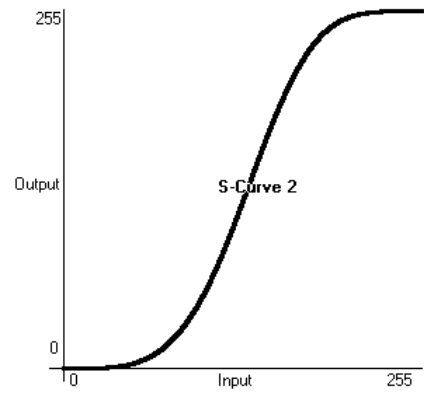
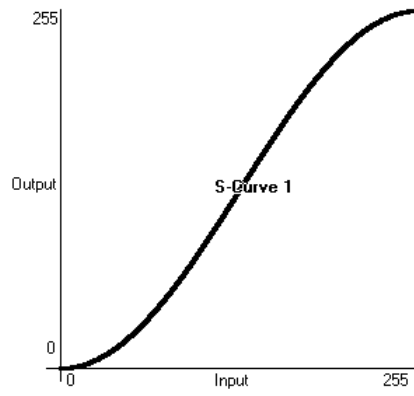
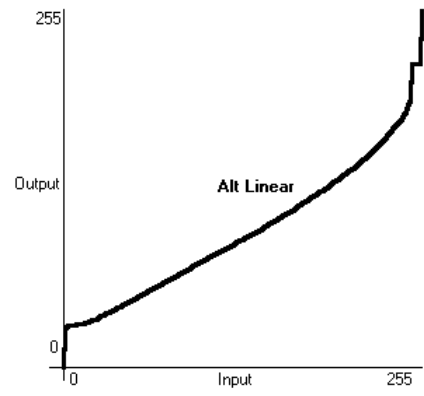
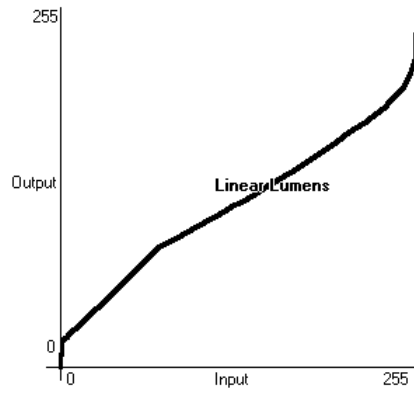

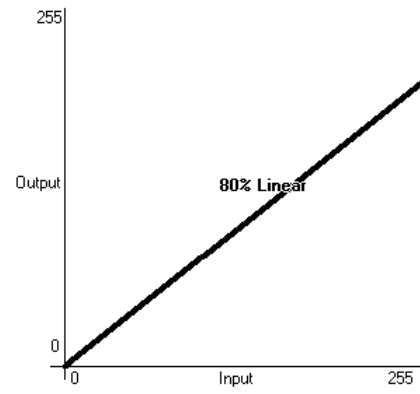
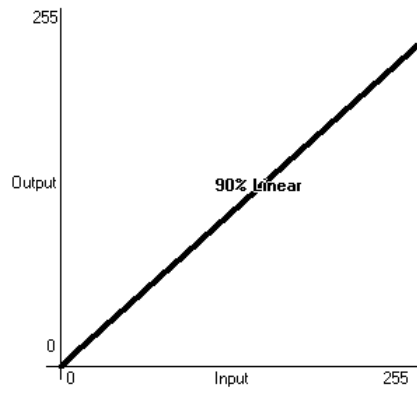
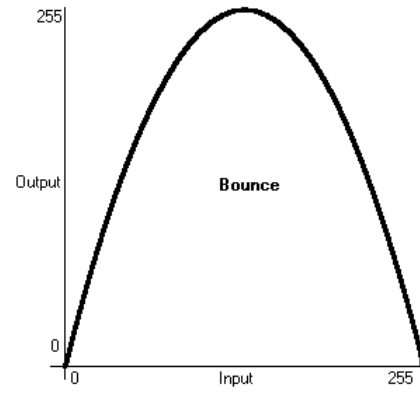
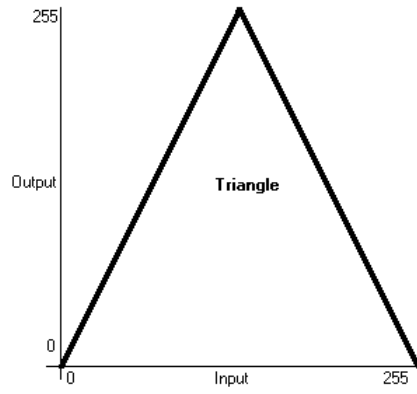

13.8 Upgrading the software

The console operating software is under constant revision by the Avolites team. You can always download the latest version of the software from the Avolites website:

<http://www.avolitesdownload.com>.



From v10 it is possible to install multiple versions of Titan on a console, which is useful for backwards compatibility if you need to load a show created in an older version. To swap between versions go to Switch Software on the Tools menu.

- If you are upgrading the software from a version earlier than v7.4, you will have to obtain a licence from Avolites. See the next section for details of how to do this.

Software upgrades for the Tiger Touch, Quartz and Arena must be installed from a USB pen drive. The Sapphire Touch and Pearl Expert has a CD-ROM drive which can be used instead of USB if you prefer.

Having downloaded a new version of software, copy it to the media and install it on the console like this:

- 1> Copy the installer file to a USB drive and insert into the console.
- 2> On the screen tools menu, stop the console software using the Shutdown Software button at the bottom of the list.

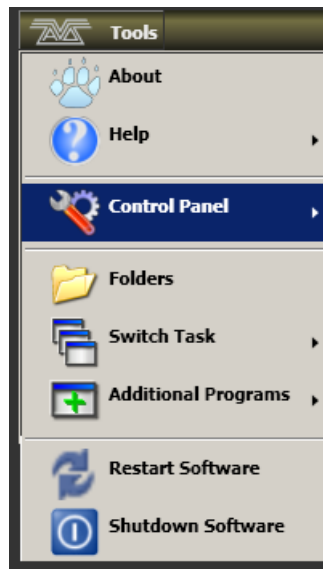

- 3> Open the tools menu again, touch the Folders icon and open the drive where the upgrade file is found.
- 4> Run the installer.
- 5> When the installation has completed, shut down the console and restart it. This will allow any operating system updates to install.

13.9 Recovering/reinstalling the system

The console runs on an embedded PC system, and like all computers, there is a possibility of system failure. The console software can be reloaded using the recovery USB stick (or CD, if a drive is fitted) provided with the console, or you can download a recovery disk creator application from the Avolites download website which will automatically create a recovery stick.

Some consoles may require you to change the BIOS settings to allow them to boot from the USB recovery stick. If the console does not boot into the recovery application, use the procedure below. You will need to have a USB keyboard attached if the console does not have one fitted as standard.

13.9.1 Booting from USB recovery stick

- 1> *Ensure memory stick is plugged in.*
 - 2> *Start up console pressing Delete button to enter the BIOS.*
 - 3> *When prompted, type in the password '68340', to enter the BIOS.*
 - 4> *Once in the BIOS, press down arrow once then Enter button to open the second menu.*
 - 5> *Then again, press down arrow once then Enter button to open the second menu.*
 - 6> *Press the PgDn button repeatedly until 'USB-HDD0' is in position 1.*
 - 7> *Press F10 then Enter, to save changes.*
 - 8> *When the console starts it will boot automatically into the memory stick.*
-

After you have installed the software, go back into the BIOS and change boot back to the internal hard disk.



Using the recovery stick will delete all settings and files from the console including show files and user personalities. Any files should be saved to a USB stick before continuing.

13.9.2 Installation Instructions

- 1> *Wait while the memory stick boots up, this can take up to 3 minutes.*
 - 2> *Once the memory stick has booted, the touch screen will display 'Welcome to (Console Name)', touch Next to continue.*
 - 3> *Please read to the bottom of the licence agreement then touch Agree to accept.*
 - 4> *On the next screen type in the serial number of the console (using the numeric keypad) - this is the number written on the back of the console.*
 - 5> *Touching Install will then format the hard drive and copy the setup files to it.*
 - 6> *Once complete unplug the memory stick and touch the Restart button.*
-

After starting the console will install all the software and drivers required to run. This takes approximately 30 minutes to complete during which the console will reboot a number of times. Please do not switch off the console during this process.

13.9.3 Software licensing

Once complete the console will boot into the operating system and you will be required to load a licence code to unlock Titan. Each console has a unique licence code which is obtained from the Titan Licensing section of the Avolites website. The licence code is manually processed and can take up to 5 days to be returned to you. However, an instant automatic temporary licence code is also sent to you which will work for 14 days, in case you are reloading the console in an emergency.

The licence code remains the same unless the console hardware is changed, so if you are reloading the software from an Avolites-provided recovery stick the licence code should already be on the stick and you can just select Import

14. Fixture Personalities

For each type of fixture, the console has a “personality” file which tells it how to control the fixture, which channel is the dimmer (HTP) channel, and a large amount of other fixture-specific information. When you patch each fixture, you tell the console which personality to use for it.

The console holds a personality library containing all commonly used fixtures, but new fixtures are appearing all the time and Avolites are constantly updating the library.

We recommend that you should update the library from time to time to take advantage of new fixtures, as well as receiving bug fixes for personalities and new features which may be added such as subfixtures.

14.1.1 Downloading fixture personalities from Avolites

The Avolites website lists all fixtures for which personalities have been created. You should look here first if the console does not contain a personality for your fixture. The address is

<http://www.avolitesdownload.com/personalities/>

Fixture Name	Desk	File Name	Name On Desk	Last Update	DMX	Disk	Cache	Details	Report Bug
Mac2000 Profile	Pearl Expert Titan	Martin_MAC 2000 Profile.D4	Mac 2000P	25/08/2009					

All available fixture personalities are listed down the left side of the screen. You can use the boxes on the top left to filter the list to show fixtures from specific manufacturers, or fixtures available for a certain console, or to search for a specific fixture name.



Ensure you have selected the correct console type in the “Desk” field. All Titan consoles use the same personalities, but the installer program is customised to the different consoles.

Click on the fixture name to open the details in the right hand window. This shows all the personalities available for that fixture type (if you have entered the console type on the top left, only personalities for that console will be displayed).

If the personality is included in the standard library (cache) then the column will be ticked.

If there is a personality listed for your fixture, download it by clicking on the Disk icon. This will download a copy of the complete personality library.

14.1.2 Updating the personality library on the console

Download the current Titan personality library by clicking on the disk icon in the Cache column for any fixture. Alternatively you can get this file by clicking on the Download link at the top of the screen, then clicking on the link for your console.



Updating will overwrite any custom personalities you have stored in the library. To avoid this, store your custom personalities in the user personalities folder (see next section for details).

To update use the following procedure:

-
- 1> *Copy the downloaded file onto a USB pen drive and plug in to the console.*
 - 2> *Click the 'Tools' menu on the toolbar, then the folder icon on the menu.*
 - 3> *Locate the downloaded file on the USB drive and double click on it to run it. Click 'Ok' on the warning box.*
 - 4> *Shut down and then restart the console (using the Restart Software button on the screen Tools menu is OK).*
-

- The console caches the FixtureLibrary folder into memory when the Patch option is first used, so you need to restart the console software (from the Tools menu) to ensure new fixture personalities are loaded.
- Once a fixture is patched, its personality is embedded in the show file. Any changes to the fixture library will not affect fixtures patched in the show. You can use the [Update Personality] option in the patch menu to update patched fixtures if you need to.

14.1.3 User/custom personalities

Using the Personality Builder application installed with the console software, you can create your own personality if you wish to modify the behaviour of a standard personality or you have a fixture the console has never heard of and need to get it working quickly.



The console loads the fixture library into memory when the Patch option is first used, so after creating a new personality you need to restart the console software from the Tools menu or it will not show up.

You can incorporate your custom personality into the standard fixture library on the console, however there is a danger that it will be overwritten when you next update the Fixture Library from Avolites.

To avoid this the console provides a special folder for user-provided personalities located at

D:\Personalities

If you are using the Titan Simulator, the folder is located at

\My Documents\Titan\Personalities

When patching fixtures, this folder is searched first before the library. If a suitable Fixture Personality is found, the console will use it rather than using the library. This folder is not affected when the personality library is updated.

14.1.4 Requesting a new fixture personality

If a personality does not exist for your fixture, Avolites will create one for you. Click on the "Request" link on the above web page to submit your request. A list of current requests is shown, so you can check if someone else is asking for the same thing.

Your new personality will be incorporated into the library – to install the new personality, download and install the latest personality library as described above.

14.1.5 Reporting a personality bug to Avolites

If you find a problem with a fixture personality, Avolites would like to know about it so it can be fixed. Search for the personality on the website then click on the "Report Bug" icon on the right of the screen. If you click on the "Bug Reports" tab at the top of the window, a list is shown of currently outstanding problems, so you can check if someone else has already reported the problem.

14.1.6 In an emergency

The console contains a selection of "Generic" fixtures which you can use in an emergency if you need to operate a fixture with no personality. When patching, go through the manufacturer list until you find [Generic]. In this section (among other fixtures) are the following:

Multi-DMX: Has up to 10 DMX channels, all channels are LTP. You can select from 1-10 channels on the Mode screen. Press Attribute Bank and use the softkeys to select channels.

Generic RGB: Allows you to control an RGB fixture such as LED colour changers. This offers 5 modes:

1=Dim 2=R 3=G 4=B

VDim 1=R 2=G 3=B

1=R 2=G 3=B 4=Dim

VDim + 4xRGB

4xRGB.

VDim is a virtual overall dimmer channel for fixtures without a DMX dimmer control. When you use the Dimmer attribute the console will adjust the RGB levels accordingly.

15. Networking the console

There are a number of ways for the console to communicate with lighting fixtures beyond the traditional DMX sockets, and these are described in this chapter.

You can also connect networked processing nodes, which allow you to control up to 64 universes of DMX (the console itself can produce up to 12 universes).

The console may also be networked with other Titan consoles for multi-user control, and for tracking backup.

At the end of the chapter is a section which aims to cover the basics of IP addressing, which is essential for various features on the console such as Art-Net.



Lighting networks need to transfer of large amounts of data. For best reliability you should use network wiring which is dedicated to the lighting system and physically isolated from other networks, and uses simple hubs rather than intelligent switches.

Connecting to an existing network with other network traffic is possible but can lead to problems both with the lighting equipment and with other IT equipment on the network. Intelligent Ethernet switches may drop or block lighting data. If you need to do this please read about the IP addresses you should use, in section 15.5.5.

If the console has multiple network ports, DMX will be output on all ports. You can set this from the DMX module properties in the DMX Settings window, each port is listed with a switch to enable or disable it.

15.1 Controlling fixtures over a network

Before the console can talk to another device over the network, it has to be given a unique network address. This is called its "IP address".

15.1.1 Setting the console's IP address

We recommend that you use the console's automatic IP setting function. However, if you need to you can also set the IP address using Windows Control Panel as shown on page 270.

-
- 1> Switch to System mode and press [Network Settings]
 - 2> Press [Local Area Connection].
 - 3> Press [Subnet Mask] and set to 255.255.255.0
 - 4> Press [Set IP 2. *. *. *]
 - 5> Press [Save settings]
 - 6> Exit system mode.
-

- Some equipment may operate on IP addresses 10.*.*.* (softkey D) – see later in this chapter for details.

- If you need a non-standard IP address range you can use softkey A.

15.1.2 Setting up DMX outputs

The console has 64 DMX output lines (up to 12 on the console itself, with further lines available using networked DMX processing nodes). The Titan One dongle is limited to one DMX line. The lines may be routed to physical DMX sockets and/or to network nodes.

Section 13.6.1 on page 249 tells you how to set up this routing, and an example is given in section 15.1.4 on the next page.

15.1.3 A simple Art-Net system

There are various different systems for sending lighting control information over a network. One of the most widely supported is Art-Net.

Art-Net is not specific to one range of products, and is recognised and implemented by a growing number of manufacturers. Many products (such as Dimmers and Moving lights) can accept the Art-Net signal directly, so there is no need to convert the signal to DMX. Most people will, however, need to output DMX to their equipment and this can be done using an Art-Net to DMX converter.

In the following diagram, an Art-Net compliant Console (such as a Titan console) is connected via a network hub to an Art-Net compatible dimmer and 2 DMX conversion boxes.

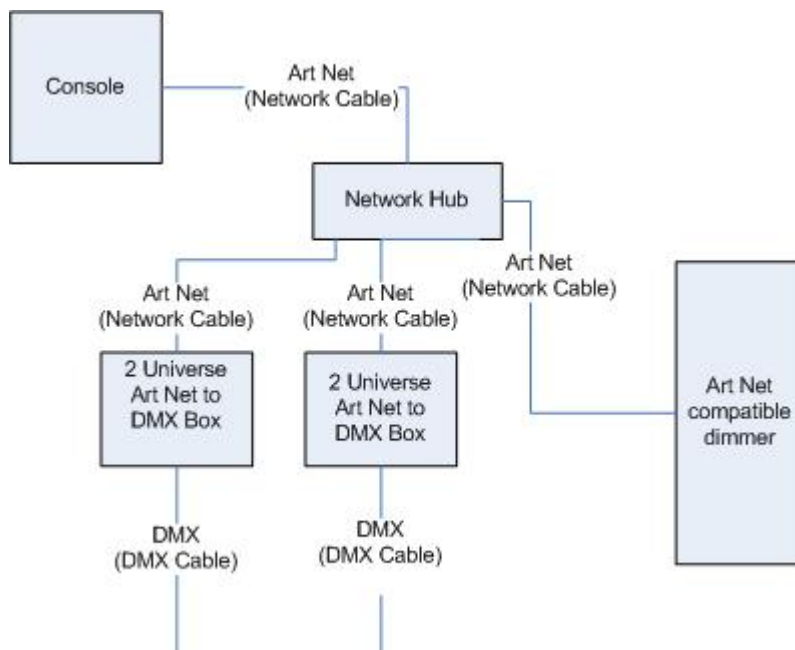

Once the system is connected together, the different outputs (or Nodes) can be configured.

- The dimmer is given the start address of 200
- The 1st DMX box is set to universe 1 and universe 2
- The 2nd DMX box is also set to universe 1 and universe 2

The console is then used to set the DMX lines to the Art-Net nodes.

It is important to remember:

- Each Art-Net to DMX box (or compatible Dimmer, or compatible moving light) is a device,
- Each device may have one or more nodes(i.e. the Art-Net to DMX box has 2 nodes, these are the 2 DMX outputs; the dimmer itself is a node),
- Each node can be set to a Universe (1-256). This universe is equivalent to a 512 channel DMX line

You can then specify which console line is assigned to each node. A console line can be assigned to multiple nodes (this will duplicate the DMX universe), but each node should have only one console line assigned to it.

Here, the console assigns the following:

- Line A to Box 1 universe 1 and box 2 universe 1
- Line B to Box 1 universe 2
- Line C to Box 2 universe 2 and the dimmer rack

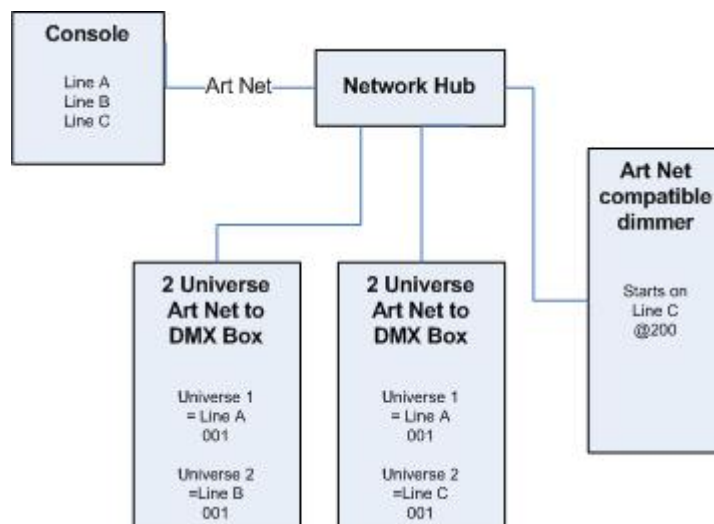

15.1.4 Setting up an Art-Net system

For this example, it is assumed that you will connect the console to an Art-Net DMX output box (such as an Artistic License Net-Lynx) via a network hub.

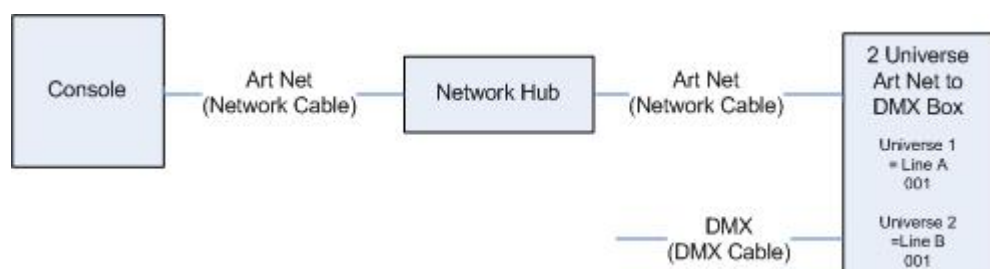

Using standard RJ45 ethernet cables, attach the devices together.

- If you are using a hub/switch as shown above, use straight-through patch cables. If you are directly connecting the console to another Ethernet device you need to use crossover cables.

Set the Net-Lynx box as follows:

- Subnet Mask = 0

- DMX A Universe = 1
- DMX B Universe = 2

A lot of Art-Net devices, including the Net-Lynx box, are set to IP address 2.x.x.x as default, and can be set to 10.x.x.x using an option jumper, so you should check what the setting of your device is.

If your Art-Net devices need to be set to a non-standard IP address, then in steps 1 and 2 you need to use Windows Control Panel to set the console to that address range instead of 2.x.x.x

With everything connected, start the console.

-
- 1> *Ensure the console has an IP in the 2.x.x.x range as described at the start of the chapter.*
 - 2> *Switch the console to System and select [DMX Settings].*
 - 3> *The DMX Settings window should open.*
 - 4> *Select the Art-Net module from the node list in the left hand side of the window.*
 - 5> *Press the small 'i' button to show the node properties. Ensure that the correct Network adapter is set (this may not be the Default Adapter)*
 - 6> *If you wish to turn off the Art-Net output, you can unselect the "Enable DMX output" option. This will stop the Console from outputting Art-Net on any Lines.*
 - 7> *Art-Net normally only sends Data when it is changed, rather than a continuous stream. There are times when it is preferable to send Art-Net all the time. to do this, select the "Continuous Art-Net Data Stream" option.*
 - 8> *The "Always broadcast Art-Net" option enables you to send Art-Net to the entire network, rather than a specific IP address.*
 - 9> *Press the blue → arrow on the Art-Net node to connect it to a DMX output line.*
 - 10> *Select a console DMX line from the right hand side of the window.*
 - 11> *The DMX line will now be outputting over the selected Art-Net node.*
 - 12> *Click 'i' on the node you have added to make sure the properties are correct. (Problems can be caused if you attach multiple DMX lines to a single node.)*
 - 13> *Make sure that the Universe is set to 1 for Line 1, and 2 for Line 2.*
*Art-Net uses a subnet mask with its universe. For Titan purposes:
Titan universes 1 - 16 are subnet mask = 0, Art-Net universes = 1 - 16*
 - 14> *You can close the DMX settings window.*
-

The console should now be working correctly.

To remove a node from a DMX line, select the node and click the blue X button.

"Unpolled" and "unknown" devices may appear as Art-Net nodes.

- An unpolled device is a 'rolling extra' which allows more than 4 connections to be made to a particular Art-Net device. The Art-

Net specification only allows each device to advertise a max of 4 universes so if you need to add more the console has to invent the 5th, 6th, etc universes.

- An unknown device is one which doesn't format an Art-Net poll reply properly so the console doesn't know if it is an input or output device.

15.1.5 Additional Art-Net Resources

To find out more information about Art-Net please refer to the Art-Net Standard published by Artistic Licence.

15.2 Connecting to a simulator with ACDI

ACDI is Avolites' Application for Interfacing Consoles and Simulators with lighting software such as Visualiser, Capture or Show designer.

15.2.1 ACDI

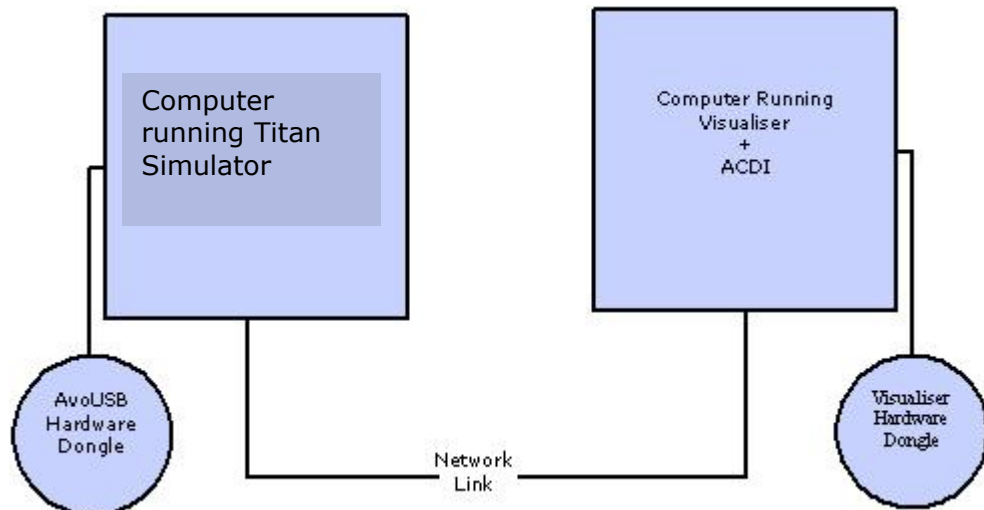

The network link connection can be made through either a crossover cable, or through a network hub.

For this example, both computers are connected together via a crossover cable.

First, we will set up the Network setting for both computers. It is important that both computers use an IP address in the same range (2.0.0.x in this example) and have the same subnet mask, or they won't be able to communicate.

On the console, set the address to 2.x.x.x as described in section 15.1.1 at the start of this chapter. If you need to set a custom address to match the visualiser PC you can use Control Panel to do this.

On the computer running the Visualiser:

- 1> Click Start, Control panel, Network connections.
- 2> Right click on the connection you wish to use.
- 3> Click Properties.
- 4> In the connection properties window select TCP/IP and click Properties.

- 5> Set the PC network adapter to a free address on the network in the range 2.0.0.x.
 - 6> Set the subnet mask to 255.0.0.0.
 - 7> Click OK.
-

Close any network windows on both machines.

Install and run ACDI on the Visualiser Computer.

In ACDI change "Source" to "Simulator"

Do not close the ACDI window

Refer to the previous section to setup a DMX line on the console to be sent to the Visualiser.

Finally, start the console, and open or create the theatre file. (See the Visualiser manual for more information on this)

Once ready to connect to the console, go to run mode in the Visualiser, and select simulator under DMX.

The console should now be working with the Visualiser.

15.3 Module Setup

A module is a method of sending DMX and can be thought of as a collection of nodes.

For example, consider using wireless networking technology to transmit DMX to several individual receivers. Each receiver is configured to output a specific universe of DMX. In this case, the wireless system as a whole is the module, and each receiver is a node.

You can set the specific properties of the Modules used with the console by going to the DMX Settings window (switch to System mode and select [DMX Settings]) and then click the small 'i' at the right hand side of the module name.

This allows you to adjust settings for each module, and to select a network adapter for ACDI and Art-Net. The consoles only have one network adapter, however on Titan Mobile and Simulator this depends on your computer; many laptop users will have their standard network adapter and also a Wi-Fi (wireless) adapter, both of which will be shown.

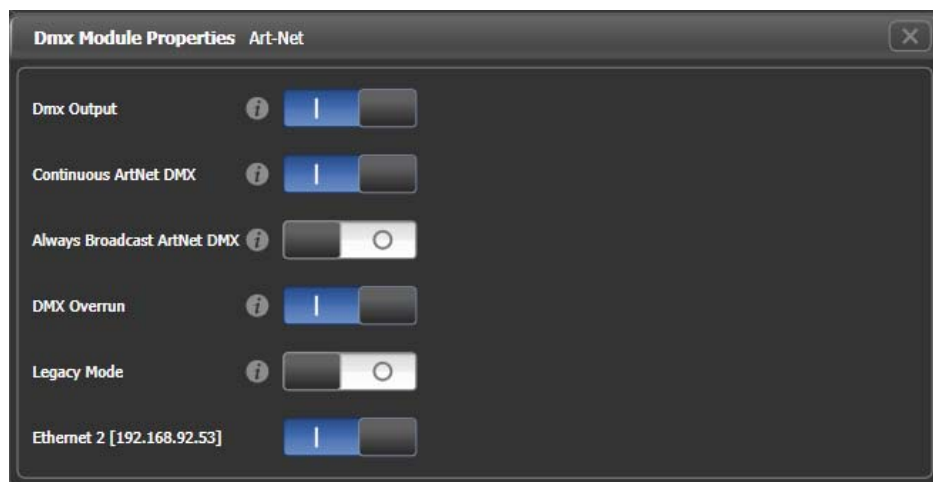

15.4 Using Active Fixtures with CITP

CITP is a standard system allowing lighting devices to communicate and share information. This is often used with media servers to allow the console to get media thumbnail images and layer information from the server. The thumbnail images can then be used on the console to select media clips.

15.4.1 Example CITP setup

This example shows how to set up a Hippotizer with the Quartz .

- 1> *Connect the console and Hippotizer to the network. (You can connect the Hippotizer directly to the console, if no other devices are being connected, using a crossover patch cable).*
- 2> *Set up the IP addresses and subnet masks of the console and Hippo so that they are on the same address range, for example 192.168.0.1 and 192.168.0.2.*
- 3> *If you are using Titan Mobile or Titan Simulator ensure the firewall on your PC is disabled. Also ensure the Hippo machine is not running a firewall.*
- 4> *Run the Hippo system. Make sure the CITP component is running.*
- 5> *Switch the console to System mode and select [DMX Settings].*
- 6> *On the left hand side under Art-Net you should see the Hippo with its IP address. Click on it and then on the right hand side click on the DMX line you want to use it with.*
- 7> *On the Hippo node on the left hand side, click the 'i' button and set the Universe number to match the universe setting on the Hippo.*
- 8> *Exit System mode back to the default menu.*
- 9> *Restart the console software using the option on the Tools menu.*
- 10> *Go into Patch mode and select [Active Fixtures]. You should see the Hippo with its IP address as a softkey option.*
- 11> *Select the Hippo, then set the DMX line to match the line you set in Step 6.*
- 12> *Press an empty fixture handle to patch. The console will automatically patch the required layers and master layer as a series of fixture buttons.*
- 13> *Now if you select a fixture and open the Attribute Editor window you should see the media thumbnails.*

The next time you start the system, ensure the Hippo is powered up before you start the console.

If you decide to re-patch to a different DMX address you will need to re-start the Hippotizer software. You will also need to reset the Art-Net nodes if you are moving across DMX lines.

15.5 All about IP addressing

This section attempts to explain the basics of IP addressing, and what you will need to know when setting up a lighting control network.

IP addresses will normally come in the format "w.x.y.z" where w, x, y and z are numbers between 0 and 255. For example "192.168.0.1". Every object (or node or device) on a network should have a unique

IP address. This is the same concept as DMX as each fixture requires a unique DMX address, for IP addresses the same is required.

15.5.1 Setting your IP address

The console has a setup function to quickly set its IP address as described on page 263.

There is a strong possibility that if you set the IP address on one network device you will have to set it on all of them, therefore if you manually set your IP address on the console you will have to do it on any TitanNet devices you are using and any Art-Net fixtures. Beware that some Art-Net fixtures have a fixed IP address in the range 2.x.x.x, in which case you have to set the console to that range.

15.5.2 Subnet Masks

These are best kept simple. All devices or nodes on a network who wish to communicate with each other must have the same subnet mask. The mask determines which parts of the IP address are unique in that network to each node. If the part of the subnet mask is a 0 then the corresponding digit in an IP address must be unique for each fixture. If the part in a subnet mask is 255 then this part of the IP address needs to be the same for each node.

15.5.3 Choosing an IP address and Subnet Mask

This is the hardest part of setting up a network as your IP address totally depends on what you are using on the network and what IP addresses you can and cannot change. Below are a number of different scenarios for standard lighting networks using a Titan console and what IP addresses should be set. These aren't guaranteed to work but try them if the scenario matches your network:

Titan and ShowSafe, all output is standard DMX.

	IP Address	Subnet Mask
Titan console	192.168.1.30	255.255.255.0
ShowSafe	192.168.1.31	255.255.255.0

Titan outputting over Art-Net Fixtures (and DMX).

	IP Address	Subnet Mask
Titan console	2.100.100.100	255.0.0.0
Art-Net Fixtures	2.x.y.z	255.0.0.0

Or

	IP Address	Subnet Mask
Titan console	10.100.100.100	255.0.0.0
Art-Net Fixtures	10.x.y.z	255.0.0.0

Where a combination of x, y and z are unique for these fixtures.

Titan and ShowSafe outputting over Art-Net (and DMX).

	IP Address	Subnet Mask
--	------------	-------------

Titan console	2.100.100.100	255.0.0.0
ShowSafe	2.100.100.101	255.0.0.0
Art-Net Fixtures	2.x.y.z	255.0.0.0

Or

	IP Address	Subnet Mask
Titan console	10.100.100.100	255.0.0.0
ShowSafe	10.100.100.101	255.0.0.0
Art-Net Fixtures	10.x.y.z	255.0.0.0

Where a combination of x, y and z are unique for these fixtures.



Never set the last number of an IP address to be 255. This is a special address which will not function correctly.

15.5.4 Automatically assigning IP addresses (DHCP)

There is another way of assigning IP addresses via an automatic system called DHCP. For this you need one of the devices on the network to be a DHCP server. If you know none of your devices are a DHCP server then this is irrelevant however, if you have a router on the network or some such similar device then it is likely that you have a DHCP server. If you do then in the 8 step instructions in section 15.5.1 on page 270 when you come to step 7 you should ensure that "Obtain an IP address automatically" is selected then press ok. When you are using DHCP all the devices on the network must be capable of obtaining an IP address automatically. If one device cannot (eg some Art-Net devices) then you must manually set all the IP addresses.

15.5.5 Private IP address ranges

If your network is connected to the internet it is important to use a private IP address range. These are special IP addresses that will not be routed onto the internet. They are:

Start Address	Final Address	Subnet Mask
10.0.0.0	10.255.255.255	255.0.0.0
172.16.0.0	172.31.255.255	255.255.0.0
192.168.0.0	192.168.255.255	255.255.255.0

For Art-Net, the 10.x.x.x range must be used.

16. Using different Avolites consoles

If you are used to other Avolites consoles, this section will help you to cope with the differences between each console.



Shows from a Titan console can be loaded into any other Titan console, but not into the Pearl Expert running Classic software, or a Diamond 4, or a Pearl 2000/2004/2008 console, because these consoles have a different show file format.

16.1 The console controls

Cues and Chases on the touch screen

In addition to the playback faders, you can store cues (memories) and chases on the touch screen using the Playbacks window. For playbacks which don't need a fader, this gives you instant fingertip access to an enormous number of effects.

Change button functions

You can change the functions of the blue and grey buttons on the console to give you quick access to the functions you want, such as Preload, Stop and Go for chases, Tap Tempo and so on. This feature is called Key Profiles (see page 233).

16.2 Programming features in Titan

There are some great programming features in Titan consoles which previously were only found on the Diamond 4.

Fixture Overlap, Attribute Overlap

The overlap functions allow you to sequence the way a cue plays back. Normally when you fire a cue, everything would move to its programmed setting all together. The Fixture Overlap feature causes each fixture to move to the new setting in sequence, giving some amazing roll or peel effects without any programming. Attribute overlap is a similar effect with different attributes. When "busking", palettes can also be applied with overlap.

Fixture Exchange and Copy Fixture

The Fixture Exchange function enables you to replace fixtures which are used in your show with alternative fixtures, retaining important elements such as cue times, shapes and legends. It is very useful for touring shows and venues with a high turnover of events, allowing you to cope with different house rigs or equipment availability.

You can copy fixtures you already have in your show. The new copy will come complete with all the cues and palettes of the original fixture you've copied.

Multiple times

The Titan software allows multiple timers for cues. This means in a complicated show you can have lots of fades going on from different cues each under the control of a different timer.

Playback priorities

You can configure how playbacks will behave if you turn on two playbacks controlling the same fixture. For each playback, priority can be set to Low, Normal, High or Very High. If a fixture is being controlled by a playback and you turn on a playback of the same or higher priority, then the new playback will take over. However, if the new playback is set to lower priority than the first playback, the fixture will not change.

This is useful if, for example, you've programmed looks using all your fixtures, then you decide you want a couple of them to spotlight a singer. If you set the Spotlight playback to be high priority, then while it is active no other playback will affect the spotlight fixtures.

Undo/Redo

Undo/Redo buttons allow you to undo an action if you do something and later regret it.

Release

When a playback is killed, you can set how the LTP channels release. The default setting is to not release any attributes (i.e. LTP channels will not change when the playback is killed), but you can set attributes to revert to their state in the most recently active playback.

17. Release notes

This section describes changes in the most recent version of software. Please ensure you save and backup your shows before attempting to upgrade any software.



This section only lists the changes in the most recent update; for changes in earlier versions, please check the release notes provided on the console using the VDU menu option Help → Release Notes.

17.1 Version 10.0

17.1.1 Upgrade procedure

All Consoles

Please note that version 10 and above will not work on original Tiger Touch and Pearl Expert consoles without the 'Pro' upgrade including the UPS board. Additionally all consoles require 4GB of RAM and a 40GB SSD. Please contact Avolites for further information.

Consoles Before 6.0

For consoles on versions prior to 6.0, the instructions in the V6 Upgrade Guide must be followed before installing version 10.0. A copy of the guide and all the files required can be found at <http://www.avolites.com/V6Upgrade>. After V6 Upgrade is complete, please follow the instructions below to upgrade from version 6 to version 10.0.

Consoles 6.0 and above

For consoles the software must be upgraded by running a version 10.0 recovery stick. You can download the 10.0 recovery stick from <http://www.avolites.com/software/latest-version>. Please follow the instructions given when downloading the recovery stick to install version 10.0. When running the recovery stick, selecting Standard Recovery will retain any shows saved on the console and preserve your previous license. If you are running a Full Erase recovery then you can reuse the license which was emailed to you previously.

PC any version

Please note that as of version 7.0 Windows XP and Vista operating systems are no longer supported. Supported versions on Windows are Windows 7, Windows 8, Windows 8.1 and Windows 10. This affects Titan One, Titan Mobile, Titan Simulator and Personality Builder. Please ensure you save and backup your shows before attempting to upgrade any software. You can download the latest Titan software by clicking on the relevant console <http://www.avolites.com/software/latest-version>. Please download the setup file to your computer. When it has finished downloading find the setup file and double click to run it. Follow the instructions presented by the installer, taking care to read each step carefully. Once the setup completes you need to restart the computer.

Titan Remote Apps

Users wishing to use Titan Remote with version 10.0 should download the new Titan Remote V10 app from the relevant app store. The existing apps will continue to work with previous Titan software versions.

17.1.2 New Features in v10.0

1. Capture Integration

The Capture Visualiser engine has been integrated into Titan. This provides high quality three dimensional simulation for pre-visualisation and blind mode output over 64 universes.

Where consoles have a dedicated Visualiser key (including factory workspace shortcuts on executors) pressing this will now open the new Capture Visualiser window. Alternatively there is a new [Capture Visualiser] option in the Open Workspace Window softkeys.

By default the window will show a perspective view facing the stage and any compatible fixtures patched will automatically appear in the Capture theatre. Where fixtures are selected in Titan they will also highlight in Capture to help identify which are being edited. Capture theatres are automatically saved inside normal Titan showfiles.

There are a number of buttons available in the Capture Visualiser context menu:

- 'Quad View Mode Disabled/Enabled' toggle. When set to 'Disabled' (default), the whole window shows the view currently assigned to Camera 1. Setting to 'Enabled' changes the display to show four camera views simultaneously. This also reveals a new context menu button that toggles between the four camera's. When in this mode the camera selection determines which view is being controlled when adjusting camera positions.
- 'Move Camera' links camera position controls to the wheels and also opens the 'Set Coordinates Values' menu with relevant softkeys representing the available values. These adjust the camera position left/right, up/down and in/out relative to the current view. Selecting a softkey provides a way to input values numerically where the [-] softkey provides a way to input negative values and the [+/-] softkey will toggle the current value between positive and negative.
- 'Rotate Camera' links camera rotation controls to the wheels and softkeys. These rotate the camera on its spot.
- 'Orbit Camera' links camera orbit controls to the wheels and softkeys. These move the camera around the stage.
- 'Position - Orientation' links the wheels to adjust the position and orientation of any selected fixtures. This also automatically changes the Wheel mode to 'Visualiser' where the visualiser controls are assigned to the position attribute group. To regain control of fixture attributes (or times) by wheel, toggle softkey G in the root menu as required. To return to capture controls either toggle back to [Wheels=Visualiser] and select the position attribute group (if different) or select the option from the Capture window context menu again. Pressing the 'Position - Orientation' context option or position attribute group key

repeatedly will cycle the wheels through the pages of options. Position moves the fixtures left/right, up/down and forwards/backwards relative to the current view and Orientation rotates each fixture (for example to match the focus position of a conventional fixture or the rigging orientation of a moving head).

- 'Rotation' links the wheels to adjust the whole selection around its centre point (for example to match the location/angle of a truss).
- 'Scale - Fan' provides a way to quickly adjust the relative spacing of the selected fixtures. The Fan function can also be switched on and off using the Fan button and will obey the fan settings (ie. curve, group and split).

Pressing the associated @key or touching the appropriate value in the wheel display will open the Adjust Attribute Value menu where you can input values numerically. Pressing the [Reset to default value] softkey will return the selected value to default. [Mirror Values] will swap between positive and negative values to provide a way to quickly position something symmetrically. The [-] softkey provides a way to input a negative value.

Touching in above or below the wheel value in the touch wheel display will nudge values up or down respectively. For fixture orientation and rotation this will jump in increments of 45 degrees, providing a quick way to align with common real-world scenarios.

'Open Settings' will open a new window called 'Capture Visualiser Settings'. This can also be opened from the Open Workspace Window menu.

Selecting the Cameras tab reveals three touch pads in the main display area. Touching and dragging in these pads provides a quick and intuitive way to position the camera with the option of maintaining attribute wheel control at the same time. The right-most pad can be switched between rotate and orbit modes by selecting the relevant button underneath.

To the left of the pads are quad view buttons. The top-most button toggles in/out of quad view. When in single view the four buttons underneath are greyed out. When in quad view you can use the four buttons to determine which view is currently being controlled.

Above the quad view and pad sections are shortcuts to camera positions. These can be used to quickly recall and assign camera positions for the currently selected view. Four factory positions are provided by default. Pressing the [+] button opens the 'New Capture Camera Position' menu. After inputting a name for the camera position touch the dashed area or press enter to store. You can change the legend for custom positions by pressing [Set Legend] and selecting the position. To delete a position press Delete, select the position and select again or press [Confirm] to remove.

The Stage tab provides a way to add elements such as risers to the theatre. In default theatres there is a floor and back wall element. To add a new element press the [+] button and select an element from the popup. Once added, selecting one or more elements will reveal relevant parameters. Touch the legend section to input a new name for the element. Touch the colour section to reveal a colour picker where you can set the colour of the element. Drag the various

sliders to adjust associated values such as size and position or touch the numeric field to connect the control to wheels and open the set value menu. Connected wheel controls are grouped into related sets (for example width/height/depth, position and orientation X/Y/Z). Selected values can be input numerically while in the 'Set Value' menu and can be reset to default by pressing the [Reset to default value] softkey. Where a parameter can have both positive and negative values additional softkeys are provided to set a negative value and to swap the current value between positive and negative. Tapping on the compass button on appropriate controls will snap the parameter to a 45 degree step where each press will increment by 45 degrees. Holding the compass will reveal a popup dial where you can drag to the desired direction. Double-tapping a parameter will reset it to default. Selected elements can be removed by pressing the trash button. Multiple elements can be selected by toggling the select multiple button on. Adjacent elements can also be selected by marquee.

The Appearance tab provides render and haze settings. Selecting a value will connect wheels to control and allow numeric input along with a [Reset to default values] softkey and, in the case of Exposure, softkeys to input negative values [-] and toggle the current values between positive and negative [+/-].

- Ambient Lighting adjusts the level of background light.
- Atmosphere adjusts the amount of haze.
- Atmosphere Contrast sets the variance in density - a level of 100% will have the most variance; a level of 0% will be perfectly consistent.
- Atmosphere Speed sets the speed of simulated smoke movement where 100 is fastest and 0 is stop (if contrast is set to 0 this will have no effect).
- Exposure adjustment sets the simulated camera exposure.
- Bloom Amount sets the 'bloom' level at the light source. This is the 'glow' or 'halo' effect of bright sources on cameras.
- Rendering Settings Detail sets the render quality between low, medium and high. 'High' provides the highest quality simulation but requires the most resources. Choosing lower levels of detail reduces the resources required.

The Show tab provides options to import and export Capture theatres. Available shows for import are shown on the right-hand side with a Capture thumbnail. Where multiple drives are present they can be filtered with the drive buttons on the left-hand side. After selecting a show press [Import] to load the chosen theatre. After the theatre has loaded press <enter> or [Confirm] to finish. Pressing the Export button opens the 'Export Capture Show Drives' menu. To save the current theatre ensure a drive is selected, type a name for the theatre and then press <enter> or [Export]. Press [Confirm] or <enter> again to complete.

To clear the current theatre press Wipe followed by [Confirm].

When the Auto Update switch is set to the on position (default) compatible fixtures patched, exchanged or deleted in Titan are automatically added/changed/removed in the Capture theatre respectively. This function can be disabled by toggling the switch to

the off position (for example if you are using a theatre created in a stand-alone version of Capture). Note that the Auto Update function will not work for compatible fixtures patched in previous versions of Titan until they are exchanged or updated using the Update Personality function.

2. Cue Undo

The Undo function has been significantly expanded to allow undo/redo of cue programming and a large number of other console functions along with an accompanying command history.

The touch prompt area layout has been changed with current user shown on the top left and current key profile on the top right. The remaining space now shows a command history when in the root or shift menus. A new [Undo History] window is also available providing an enlarged view of the command history. Touching on the prompt area will automatically open the Undo History window. The current step is shown in bold and with an arrow (in the prompt) or in red (in the Undo History window). Use Undo and Redo to step backwards and forwards through the command history or touch in the Undo History window to go directly to a particular restore point. Where at least one step has been undone subsequent steps will be greyed out indicating they can be 'redone'. Up to 20 'programmer' and 100 'engine' restore points are remembered for undo and where commands cannot be undone they are tagged with a 'no-entry' warning symbol (red circle with a slash through it).

There is a context menu toggle [Show only current user] (default) / [Show all users and consoles]. When set to [Show all users and consoles] a separate column will appear for each user with the user name at the top and the current user in the left-most column. If one or more consoles are connected in a session a console type icon and console legend will also be shown at the top of each column. Undo/redo operations only apply to the current user.

3. Intensity View

A new 'Intensity View' window has been added. This provides an easy way to view and edit just the intensity level of fixtures in one place.

This can be opened either by pressing Open/View followed by Intensity/Dimmer or via the [Open Workspace Window] softkey menu.

There are various filters and options available to customise the view but the core elements are a handle representing each fixture with a bar meter and numeric value displaying the current intensity level as a percentage where 'FL' indicates 100%. Both live and blind values are shown. If the level is at zero the handle will also slightly grey out.

Additionally, colours and symbols are used to indicate fade transitions, tracking and effects where applicable:

- Intensities fading in are represented in light blue with an up arrow.
- Intensities fading out are represented in green with a down arrow.

- Where values are tracking from previous cues in a cuelist they are shown in magenta with an equal ('=') sign.
- Where the intensity is tracked in a solo or block cue it will show in red with a 'no entry' symbol (red circle with a slash).
- Where intensity levels are being controlled by an effect they are shown in yellow with a tilde symbol.

These handles are selectable providing a way to adjust values directly. The bar at the top of the handle represents the current selection state using the same style as other fixture handles (dark blue = not in programmer, medium blue = in programmer and light blue = selected).

The intensity view context menu provides various customisation options:

Pressing the first option ([All] by default) will open a submenu of options:

- [All] will show the current intensity level of all patched fixtures.
- [Stage] will show all intensities that are above zero.
- [Programmer] will only show intensities for fixtures currently in the programmer.
- [Selected] will only show intensities for fixtures currently selected.
- [Live cues] will only show intensities coming from active cues.
- [Connected cue] will show just intensities for fixtures in the currently connected cue (for cue-lists or chases).
- [Frozen] will show all fixtures whose intensity is currently frozen.

The [Sort] context menu option toggles between three different sort options:

- [User Number] will display handles from left to right and top to bottom following the user number order.
- [Last Selected] orders by selection history with the most recently selected fixture top left.
- [DMX address] sorts in order of DMX address.

Pressing the [Search] button will open a prompt where you can input characters to search for. This will search both legend and user number for matches and will filter matching handles as you type. When a view is filtered by search the current search string will be shown in a bar at the top of the window. This can be selected at any time to modify the search filter. Pressing the [X] button on the right-hand side of this bar will remove the search and restore the filtered handles.

[View If] can be used to filter handles to those in groups and/or playbacks. Pressing View If will cause all playbacks and groups to highlight in red and, where applicable, flash the handle LED. Selecting one will filter the intensity view to just fixtures contained in that group or playback. In the case of a chase or list this will be for all cues in the playback. It is also possible to filter a combination, for example all fixtures in group x that are in playback y. When the view

is being filtered in this way the current filter syntax will appear at the top of the window. This can be selected at any time to modify the filter. Pressing the [X] button on the right-hand side of this bar will remove the filter and restore any filtered handles.

There is also a context menu button to [Open Channel Grid]. This provides a quick way to jump to the channel grid which has a similar context menu button to open intensity view so you can flip-flop between them should you wish.

In the window appearance settings there are further customisation options. The handle size will automatically adjust depending on the appearance option settings to maximise the available space:

- Fixture Filters Shown/Hidden. When set to 'Shown' (default), a column on the left of the view will appear with buttons to filter the view by fixture type.
- User Number Hidden/User Number Shown/DMX Address Shown. When 'User Number Shown' is selected the user number of the fixture will appear in the top left of the handle. When 'DMX Address Shown' is selected the DMX address for the fixture will appear in the top left of the handle.
- Legend Shown/Hidden. When set to 'Shown' the fixture text legend will appear in the top right of the handle.
- Cue Information Shown/Hidden. When set to 'Shown', if the current intensity value for a fixture is coming from an active playback, the playback legend will be shown in the handle. Where the playback is a chase or list the cue number or legend (if set) will be shown underneath.
- Attribute Mask Shown/Hidden. When set to 'Shown' the IPCGBESFX indicators will appear and highlight when related attribute groups are in the programmer.
- Halo Colour Custom/Auto. When set to 'Auto', the border for any handles where the fixture does not have a user defined halo will be drawn with the automatic fixture type colour. Wherever fixtures have user set halo's these will take preference. When set to 'Custom', only the borders for handles where the fixture has a user set halo will be shown. This is the same as the options in User Settings and the Fixture workspace context menu.
- Fixture Cells Shown/Hidden. When set to 'Shown', separate handles will appear for every cell of any multi-celled fixtures along with the 'master' fixture handle. This can provide a convenient and quick way to select and manipulate cell attributes.

When the view is filtered to 'Live Cues' or 'Connected Cue', there is extra window appearance toggle 'Tracked Fixtures Shown/Hidden'. When set to 'Shown', fixtures with values tracked from previous cues will be shown/ When set to 'Hidden' any fixtures with intensity values tracked from previous cues will not be shown.

4. Custom Workspaces

Workspaces can now be set to custom sizes and are no longer limited to the 'quad' view layouts.

An extra window layout button has been added to the workspace title bar. Selecting this opens the Window Layout menu and puts all available screens into window layout mode with a 12 x 8 grid superimposed and the outlines of any background windows showing through to the foreground so that you can see the current size of all windows even if they are normally obscured by windows in front.

With the softkey option [Edit All Windows] set to 'Off' (default), the currently selected window will be highlighted with arrows in the top left and bottom right corners. Touching and dragging one of the corner buttons will resize the window to the nearest grid position. Touching and dragging anywhere other than the corners will set a new position and size accordingly. Tapping once anywhere other than the corners will set a start corner position which will highlight in red and prompt to tap elsewhere to set the opposite corner. With the softkey option [Resize Neighbours] set to 'On' (default), dragging by the corners will cause any adjacent windows to resize to accommodate wherever possible. When [Resize Neighbours] is set to 'Off' the size and position of windows not being edited will be maintained. After dragging or tapping twice the window layout mode will automatically exit. If you tap once on a corner arrow or tap twice in the same place the previous window size will remain and the layout mode will exit. This is to prevent accidentally setting a window that is only 1x1 grid size.

With the softkey option [Edit All Windows] set to 'On', corner arrows will appear for all open windows in the display allowing adjustment of all window sizes and positions at once. This option can also be toggled on/off with the latch menu button. Once you have completed editing windows in this mode press exit, <enter> or the [OK] softkey to finish.

In both modes the window contents are shown while editing so that you can see how the changes look.

In window options two buttons called 'Rows' and 'Columns' have been added to the appearance section. By default these are set to dynamic meaning the number of rows and columns will adjust to best fit the window and button size. Selecting the rows or columns button changes the button size toggle to a new option [Button Size Set Rows & Columns] and makes it possible to input specific quantities for the number of rows and columns. In this mode the buttons will resize to fit the current workspace size maintaining the set number of rows and columns (including whether pages are set to show or hide). This is particularly useful when fixtures are laid out to represent their locations on stage and you want to maintain the layout regardless of window size or position. The rows and columns values are remembered for each window meaning you can toggle back in/out of standard handle sizes without having to input the quantities again.

The last position, size and appearance settings will be remembered for each window type and will be restored each time the window is opened. The size, position and appearance are all stored in workspace shortcuts meaning you can have an unlimited number of preset positions and handle layouts for any window or combination of windows.

Toggling Size/Position and Min/Max (either via dedicated buttons where available or via the Window Options softkeys) at any time will override any custom size and position and use the standard quad

view locations. This can be particularly useful if you cannot access the window layout button on the title bar where windows are too narrow.

5. Shape Tracking

Tracking for shapes in cue-lists has now been fully implemented.

In the cue list playback options there is a new [Shape Tracking] option.

- [Shape Tracking Local] follows the main playback option [Tracking (on/off)].
- [Shape Tracking On/Off] turns shape tracking on/off independently of the main tracking setting.

By default this is set to local except for shows from older versions of Titan where it will be turned off.

With tracking turned on, cues containing source shape(s) have buttons for each shape with subsequent cues representing tracked shapes as greyed out. Where a shape is tracking from a previous cue a toggle switch will appear to set whether to continue tracking to the next cue (blue 'T', default) or block (white 'B'). When set to block the shape will be removed from subsequent cues. Similarly, while a cue is set to block any tracked shapes will be removed from it and any subsequent cues. If a cue is set to Solo any tracked shapes will be removed from that cue only.

There are two additional cue tracking options - [Solo Excluding Shapes] and [Block Shapes]. If a cue is set to Solo Excluding Shapes any tracked shapes other than dimmer will still function, providing a way to have a cue that solos everything except non-dimmer shapes. Setting to Block Shapes will ensure any tracked shapes will not continue beyond this cue, even if a shape is added later to a preceding cue. This provides a way to guarantee all shapes will stop at this point independently of other controls. Where a cue is disabled any cue or individual shape blocks will be ignored and tracking to subsequent cues will be restored where appropriate.

It is also possible to block and unblock per attribute during recording via the @ menu. Pressing an @ key for a wheel connected to an attribute will cause the shape button LED to flash on consoles with the dedicated button. Pressing the Shape button or FX attribute group button at this point will reveal [Block Shape] and [Unblock Shape] softkeys and selecting one of these options will set the attribute currently connected to that wheel to block or unblock respectively. @ Shape/Shape will shortcut to block. If an attribute has been set to block or unblock a watermark will appear in the touch wheel display reflecting this.

6. Live Shape Control

It is now possible to make live adjustments to shapes running from playbacks.

After pressing connect, if there are any active shapes (either from playbacks or in the programmer) the Shape button LED will flash on consoles which have a separate key. Pressing the Shape button will reveal the 'Select Shape' menu where each shape will be represented on a softkey. Alternatively (particularly for consoles that do not have the Shape key), the 'Select Shape' menu can be accessed via

[Shapes and Effects]/[Shape Generator]/[Edit]. The shape source (either 'Programmer' or 'Cue') is shown above the shape and by default all available shapes are selected ready for editing. Pressing the appropriate softkeys will toggle shapes in/out of the editor. Once the selection is complete either press the shape key again or press <enter> to connect the chosen shapes to the wheels.

Adjusting the parameters either by wheel or by numeric entry will affect the live output of all connected shapes and propagates directly into any source playbacks (much like changing connected chase speeds). Softkey G will page between the various parameters on wheels and is highlighted in blue to signify they are not controlling level. Attribute control can be regained by pressing an attribute group button. To get back to shape control press the shape key again or select the FX attribute group in the touch wheels area

7. Size Masters

An new set of assignable 'Size' masters have been added. These can be found either via Record/[Create Master] or from the System Menu/[Assign Masters].

A new [Size Source] option has been added to the playback options. When set to 'Local' (default), the size of effects in the playback will be controlled according to the local settings. When set to one of the four masters the size of any effects in the playback will be proportionally controlled by the selected size master.

There is also a 'Size Grand Master'. When assigned this will proportionally control the size of all running effects (including those in the programmer).

By default the fader scale for size masters is set to 200%. This can be toggled via playback options between 100/200/400/600 and 1000%. Additionally the scale for any size master can be set numerically by inputting the number as a percentage then selecting the relevant size master. The current value for each size master along with a graphical bar representing the current level proportional to the chosen scale is shown in the playbacks touch area.

8. New Key Frame Shape Directions

Two new directions have been added to key frame shape directions: Outside -> Inside and Random.

9. Shape Direction

Direction options are now available for 'normal' shapes. These make use of the 2D fixture layout stored in groups to quickly create shapes that run across fixtures in particular directions.

In the Shape Generator menu the [Reverse Selected Fixtures] softkey has been replaced with [Direction]. Pressing this will reveal the direction submenu where you can chose from the various new direction softkeys along with reverse selected fixtures which has now moved here. This menu can be latched so that you can quickly try different directions and see the results.

10. Motion Blur

A new type of animation called 'Motion Blur' has been added to Pixel Map Effects. This is a 'Global' effect that, when added, will create a trail effect across all animated elements in a pixel map effect.

While in the Effect Editor, pressing the [+] button and selecting the Animations tab will reveal the motion blur effect in the 'Global Effects' section. This is represented as a white box moving left to right with a trail behind it. Selecting this will add it to the top of the pixel map effect tree and open the 'Blur Amount' parameter slider. Adjust this (or select the value box to input numerically, connect to wheels and reset) to set how much trail is left where zero means no trail and 100 is the maximum.

11. Blind to Live

You can now convert blind programmer values directly to live output. This provides a way to send blind values live to stage without having to record to a playback first. It also provides a method of firing a number of palettes simultaneously (with or without timing) in a busking scenario.

To invoke blind to live, while in blind mode with values in the programmer, input a number representing the global fade time in seconds (can be zero) and then press the Blind key to fire. Any controls in the blind programmer with global times will then fade to live over the set time. Where controls have times set in the programmer (including those recalled from palettes) these will be used in preference. Any fixture overlap values will also be obeyed.

12. Ignore Chase Fade Times On Paused Step

A new user setting [Chase Snap Enabled/Disabled (default)] has been added. When enabled, using the next and prev chase control buttons on a paused chase will fire the steps without fade times. This mimics the Classic function.

13. Multiple Fixture Import Mapping

Import mapping now supports one to many making it possible to duplicate controls from one source fixture to multiple target fixtures in a show.

While in the show library mapper after selecting a source fixture you can drag select over target fixtures to map to a range of fixtures. Where the target fixtures are not adjacent you can select the source fixture again and chose additional target fixtures.

There are two new options in the Show Library context menu. When 'Mapped Fixtures' is set to 'Hidden', any source fixtures that have been mapped to at least one target fixture will be removed from the list. When set to 'Shown', any source fixtures that have been mapped to a target fixture will be denoted by a green tick watermark along with a list of the user numbers of the target fixtures they are mapped to. By setting 'Mapping Selection' to 'Latched', it is possible to choose multiple target fixtures.

After selecting 'Clear Fixture Mapping' you can now select source fixtures (assuming Mapped Fixtures is set to Shown), including ranges of, to clear all target mappings associated with those particular fixtures. Alternatively individual targets can be removed by selecting the target fixtures and all mappings can be removed by selecting the sofkey option [Clear All Mappings].

14. Set List Macros

It is now possible to fire macros and/or workspace shortcuts in set lists.

New buttons have been added to the bottom-right of the set list window to add macros and workspace shortcuts. After touching the add workspace button either select an existing workspace shortcut or press the [Record Workspace] softkey to add the shortcut or current workspace to the current track respectively. If a track already contains a workspace, softkey options to [Overwrite] or [Cancel] will appear. When a track containing a workspace shortcut is fired (either by pressing play or by changing page in set list mode) the associated workspace will open.

Touching the add macro button will reveal a popup submenu with options for [Set List] or [Track]. [Set List] will apply chosen macros globally to the whole list (even if new tracks are added later) which will fire with every track. [Track] will apply to the current track only. After choosing the global or track option, a softkey menu will appear containing all available macros. Selecting a macro will then link it to the whole list or current track. There is no limit to the number of macros that can be linked. Any macros linked to a track will fire when the associated track is fired (either by pressing play or by changing page in set list mode). Any macros linked to the global set list will fire when any track is fired.

At the top of the set list window there are also two new tab buttons. When [Notes] is selected the right-hand side of the window will show any notes associated with the current track. When [Workspace & Macros] is selected any global macros and any macros or workspaces associated with the current track will be shown. Global macros will appear as handles at the top under the section 'Set List Macros'. 'Track Macros' are macros specific to the current track and 'Workspaces' are workspace shortcuts assigned to the current track. Any workspaces or macros assigned can also be fired directly by touching the respective handle. To delete an item press the Delete key, select the item and then use the [Remove] softkey to confirm.

15. Playback Control Macros

A new set of macros has been added to control playbacks. These are particularly useful when used within cue lists and set lists:

[Fire First Playback]. This will fire the first playback on the currently selected page.

[Fire First Playback Page 1]. This will fire the first playback on page 1, regardless of current page.

[Fire Playback 1]. This will fire the playback with user number 1.

[Kill First Playback]. This will kill the first playback on the currently selected page.

[Kill First Playback Page 1]. This will kill the first playback on page 1, regardless of current page.

[Kill Playback 1]. This will kill the playback with user number 1.

[Release First Playback]. This will release the first playback on the currently selected page.

[Release First Playback Page 1]. This will release the first playback on page 1, regardless of current page.

[Release Playback 1]. This will release the playback with user number 1.

[Release Me]. This will release the associated playback (cuelist).

[Gobo My Cue 1]. This will go to cue 1 of the associated cuelist.

Note that if required it is relatively easy to create custom macros that apply to other playbacks, pages or cues where relevant by using the factory macro xml as a guide.

16. Web API

It is now possible to remotely control console functions via HTML providing a way to create custom interfaces with specific layouts and capabilities. This is available for all stand-alone consoles and Titan Mobile. Further details will be provided in separate documentation.

17. Halo

It is now possible to set colour 'halos' for handles in addition to text or picture legends. This changes the colour of the border drawn around the handle to make it easier to find or identify items. In the touch playbacks area the halo is drawn around the playback text legend space at the top.

Pressing [Set Legend] and selecting one or more handles will reveal the new softkey option [Halo]. Pressing this will open the 'Set Halo' menu and reveal a colour picker popup on touch consoles with some 'system colours' palettes underneath. Alternatively selecting the [System Colours] softkey will reveal the system colours on softkeys. Selecting one of the system colours softkeys or touching on the colour picker or on one of the system colour palettes will set the chosen handle(s) halo to the selected colour and exit the set legend menu completely unless it was latched. Halos can be removed via [Set Legend]/select handle(s)/[Halo]/[Remove Halo]. The colour picker can also be latched open providing a way to quickly set a different halo for a number of handles in turn.

For fixture handles it is also possible to use the fixture type colour automatically assigned during patch by changing the User Setting Fixture Halos to 'Auto'. In this mode any fixture handles that do not have a user set halo will use the automatic colour. When set to 'Custom' only user set halo's will be displayed. All handle halo's can be globally toggled on/off via the User Settings 'Display Halo' setting. Note that fixture handles (and the associated user settings) are also used (and can be set via) the Intensity View workspace. Fixture Halo's Auto/Custom can also be toggled in the Fixture and Intensity workspace appearance settings. Where a custom halo has been set on a fixture this will also be shown in Fixture View. If a custom halo has not been set, Fixture View will show the automatic fixture type halo.

When turned on, handle halo's are also shown in the Show Library workspace, including in import and mapping. Additionally, it is possible to set halos for other items such as set lists and tracks, playback view column filters and capture cameras.

A new static colour tag column has been added to the left side of DMX view, Channel Grid, Cue View and Palette View to help identify fixtures. Where user halo's have not been set for fixture handles the automatic fixture type colour assigned during patch will be used. Wherever fixture handles have user set halo's these will take precedence, including in patch view. These columns are always on and not affected by the halo user settings.

18. Import User Settings and Key Profiles

It is now possible to import users and key profiles from other shows.

Two new tabs have been added to the Show Library workspace.

When the current show is selected, switching to the [Users] tab will present a view showing the currently selected user and a list of all available users represented by their text and picture legends. Selecting the [Change Current User] button will reveal a popup with all available users where you can select a new user. Pressing [Legend User] will open the set legend menu from where you can set text and/or picture legends for the current user. [Add User] will open the 'Create a New User' menu. Inputting a new name here and pressing [Ok] or <enter> will create a new user based on the current settings and immediately change to this user. Selecting the User Setting button will open the new User Settings window where you can view and edit the settings corresponding to the current user.

Where at least one show has been added to import, selecting an imported show will reveal all available users in that show. Touching a user will highlight it in red and open the 'Import User' menu where there are softkey options to either [Import Over Current User] or [Import as New User]. Importing as a new user will automatically select this as the current user and preserve the previous user. When set to on (default) the [Force Import Key Profiles] toggle softkey will cause all the key profiles to import from the selected show at the same time as importing the user. If you prefer, this option can be turned off allow key profiles to be managed manually.

Switching the Show Library tab to Key Profiles, available key profiles for the selected show will appear on the left of the window and selecting these will reveal a visual description showing the various assignments for that profile. Where an imported show is selected the profile will also highlight in red along with the softkey [Import Key Profile]. Pressing this will add the chosen key profile to the current show.

19. User Setting UI

User Settings have been separated into submenus and include a number of settings that were previously only available in separate menus. In addition to the softkeys these are all now available in a touch friendly window.

Selecting User Settings from the shift or system menu will open the new User Settings window. This provides an easy way to view and adjust all the console user settings and switch or create new users.

The settings are divided into a number of sub-sections which can be selected on the left side of the window. The settings that have been added that were previously only available in separate menus are:

- Preset Palettes Disabled/On Workspaces/On Presets (from patch fixture options menu).
- Show/Hide DMX Address (from fixture workspace context menu).
- Record Nested Palettes On/Off (from record palette menu).
- Master Palette Time and Master Overlap Time (from the palette menu).
- Manage Handle Worlds (from the disk menu).
- Release To Home and Master Release Time (from the release playback menu).

- Clear options.

Tooltips have been provided to help understand the various settings. Clicking on the small 'i' button or any where on the setting title will reveal a popup with relevant information. Touching again anywhere will close the prompt.

The current user is shown at the top of the window with both picture and text legend. Selecting the [Change Current User] button will reveal a popup with all available users where you can select a new user. Pressing [Legend User] will open the set legend menu from where you can set text and/or picture legends for the current user. [Add User] will open the 'Create a New User'. Inputting a new name here and pressing [Ok] or <enter> will create a new user based on the current settings and immediately change to this user. Pressing [Import User] will open the Show Library from where you can import users (and the associated settings) from other shows.

When the User Setting window has automatically been opened via the shift or system menu options, pressing exit will automatically close it again. The window is also available in the [Open Workspace Window] menu and when opened this way will remain open until manually closed.

20. Playback Options

Playback Options have now been separated into submenus and, in addition to the softkeys, are also available in a touch friendly window.

In Playback View there are two tabs on the left-hand side. When [Cues] is selected the view will show the cues and various parameters as before. Selecting [Options] will reveal all the available playback options for the playback type. The options are divided into a number of sub-sections which can be selected on the left side of the window. Touching some options (such as key profiles and release mask) will reveal popup submenus with further options. Tooltips have been provided to help understand the various options. Clicking on the small 'i' button or anywhere on the option title will reveal a popup with relevant information. Touching again anywhere will close the prompt.

The tab selection is remembered when selecting new playbacks meaning you can easily move switch between playbacks and set or compare the options.

Note that the fader mode option (mode 0/1/2/3) is also now available from playback options as well as in [Edit Times] and for chases and cue-lists, the 'Renumber All Cues' option has been moved into the playback view context menu.

21. Playback View Columns

It is now possible to filter which columns appear in playback view to make it easier to see the items you need and avoid having to scroll. Multiple filter shortcuts can be stored and recalled.

There is a new Playback View context menu option called 'Edit Columns'. Selecting this will open the Playback View Columns menu with each column represented by a sofkey. Columns can be toggled in/out of view by pressing the relevant softkey. Pressing Record will reveal an [Add] button. Pressing this or anywhere in the column filters area will add the filter to the left-hand side of the window. If

an existing filter is selected softkey options to [Cancel], [Replace] or [Add New] are provided.

Filters can be legended (including picture legends and halos) either prior to recording by inputting a name or later via [Set Legend]/select filter. Factory [Show All] and [Times] filters are available by default. Filters can be deleted by pressing delete, followed by the filter and then either a second press or [Confirm] to complete. Finally there is a toggle option to show/hide column filters in the display appearance options.

22. Playback View Cue Progress

Cue progress indicators have been added to playback view for chases and cue lists to make it easier to visualise various timings.

For each cue a green bar will fill from left to right on top of the cue number representing the entire progress of that cue. Additionally there are separate bars underneath various timing parameter cells to show the relative progress of these individual items. For chases these are Delay In, Fade In and Fade Out. For cue-lists these are Delay In, Fade In, Delay Out, Fade Out and Link Offset.

Where move in dark (MiD) is enabled an indicator will flash underneath the MiD cells which are currently suitable for the move.

23. DMX View Fixture Filter

Fixture and attribute filters have now been added to the DMX output window. This helps make it easier to find specific information, particularly when problem solving on site.

Buttons representing all patched fixture types along with the IPCGBES attributes are shown on the left-hand side. Selecting a fixture type will filter the display to only show channels used by that fixture type on the selected line. Selecting an attribute button will filter to show just the channels associated with that attribute group. Fixture type and attribute filters can be used in combination. All fixtures and ALL attributes buttons are provided to restore the relevant filter to show all.

Additionally, an extra static colour tag column has been added to make it easier to identify multiple fixture types. Where a halo has not been set on the fixture handle these follow the default fixture type colours assigned in patch. If a halo has been set on the fixture handle this will follow the user halo colour instead.

Two new toggles have been added to the window appearance settings - [Attribute Filters Hidden/Shown] and [Fixture Filters Hidden/Shown]. By default both are set to Shown. When toggled to Hidden any related filters will automatically be reset to 'All' and when both are hidden the filter section is removed from the window.

24. Ai Media Controls

Two new graphical UI interfaces have been added providing intuitive control of various Ai functions.

After patching Ai these appear in the Attribute Editor under [Image Control] and [Media Control].

[Image Control] provides UI controls for Image Size, Aspect Mode and Aspect Ratio. The three Aspect Ratio options can be selected from buttons at the top of the display. Aspect Ratio can be adjusted

by touching and dragging in the screen representation. Image Size can be adjusted by dragging the vertical slider. A grid scale grid is superimposed over the screen representation and adjusting Aspect Ratio will dynamically adjust this to reflect the current scale. All controls can be reset to locate values by selecting the [Reset] button. Touching on the zoom parameter will connect it for adjustment by wheel or numeric input. A [Reset to default value] softkey will also appear which will reset just Image Size to its locate value.

[Media Control] provides UI controls for Play Mode, Play Speed, In Point, Out Point and Timecode. Play Mode controls are at the top of the window. From left to right these are: 'In Frame', 'Loop REV', 'Once REV', 'Pause', 'Sync MTC', 'Stop', 'Once FWD', 'Loop FWD' and 'Out Frame'. Below these are MTC controls representing 'MTC Hour', 'MTC Minute', 'MTC Second' and 'MTC Frame'. Use the up/down buttons above and below the control to raise or lower the respective value or select the pencil button to input a time. The input syntax is xx:xx:xx with a decimal point representing frame. For example typing 01:11 will set 1 minute and 11 seconds. typing 01.11 will set 1 second and 11 frames. An additional softkey will also appear which will reset the timecode to zero. Below the MTC controls are three sliders representing Play Speed, In Point and Out Point. Drag these sliders to set the associated control value or touch the parameter value for wheel or numeric control. An additional softkey will also appear which will reset the associated control to its locate value.

25. Swap DMX Address

It is now possible to quickly swap the DMX addresses of patched fixtures, for example if something has been rigged in the wrong order.

From Patch View, after selecting one or more fixture address cells, the 'Edit DMX Address' menu will appear with the new [Swap Fixture Addresses] option on softkey G. Pressing this will open the Swap Fixtures menu with a softkey toggle option [One for One]/[Retain Layout]. When set to [One to One], selecting an identical number of fixtures will cause the addresses of the original selection to swap with those selected in the Swap Fixtures. If the quantity of source fixtures doesn't match the quantity of destination fixtures the software will prompt you to ensure the source and destination match. Pressing the [Ok] confirmation softkey will return to the Swap Fixtures menu. When the toggle option is set to [Retain Layout] and there is a mismatch between the source and destination quantities it will attempt to retain the same destination layout as in the source. Where this conflicts with patched fixtures it will prompt with an option to [Park Conflicting] or [Cancel].

26. Multiple Adapter Output

By default DMX is now output on all network adapters with options to disable. This ensures Art-Net and sACN will work regardless of which port is connected and allows simultaneous transmission (for example one to live, one to visualiser etc.). This also solves a problem where adapters might change on disconnect/connect of a network cable even if it was to the same port, resulting in loss of output.

In the DMX Module Properties for Streaming ACN and Art-Net in DMX Settings, each available Local Area Connection will appear with its current IP and a toggle switch to enable/disable respectively.

27. Multiversion

It is now possible to install multiple versions of Titan on consoles. This is particularly useful for showfile compatibility where you need to use a show created in an older version. To change version go to Tools/Switch Software.

28. Arena and Quartz Simulator

The Arena and Quartz consoles have now been added to Titan Simulator

29. Highlight with Orientation

Where fixtures with three or more cells are opened in the Layout Editor the top left cell is now represented as a green cell and the bottom right as red. Enabling highlight while in this view will cause the top left and bottom right cells of selected fixtures to change to green and red respectively to help orientate fixtures to match the real world. Highlight can be toggled by the dedicated button or via a new context menu item. Where the multi-celled fixtures only have dimmers the top left cell will be highlighted at 40% (with the remainder at full).

30. Page Release

Pressing Release followed by the Goto Page button or touching the current page in touch page view will open the 'Release Playbacks on Faders' menu with three new softkey options.

- [Release This Page] will release all active playbacks on the current page and playback fader group.
- [Release Playbacks Not On This Page] which will release any active playbacks on other pages according to fader group (particularly useful where different playbacks on the same fader are active on multiple pages).
- [Release All Playbacks In This Group] will release all playbacks according to fader group.

In all cases 'group' here refers to the particular area of the console, for example the main faders below the touch screen in a Tiger Touch or Arena is one group and the top and bottom rows on a Tiger Touch wing or the left-hand side of the Arena are two separate groups.

[Release This Page] and [Release Playbacks Not On This Page] are also available in the Goto Playback Page menu available when touching the current page in the touch page wheel display.

31. Palette Fade Time Macros

A new set of macros has been added to set master palette time and overlap values. For Master Time these are 0, 0.5, 2, 3, 5, 8, 10, 15 and 20 seconds. For Master Overlap these are 0, 25, 50, 75 and 100%.

32. sACN Priority Macros

A new set of macros has been added to set the Streaming ACN merge priority. These are 0, 50, 75, 100, 125, 150 and 200.

33. Range DMX Line Assignment

It is now possible to assign a number of Art-Net and sACN universes to lines automatically. Selecting an sACN or Art-Net node now reveals [Universe] and [Quantity] softkeys. Inputting a universe start address and a quantity and then selecting a line will automatically add to multiple lines sequentially from the line selected incrementing the universe by one each time according to the quantity value.

17.1.3 Improvements in v10.0

1. Minimum palette mode

An new user setting has been added called 'Minimum Palette Mode' which determines the limits of the automatic palette type when recording. Options are Global/Shared/Normal. When set to Global if identical values are detected for all fixtures selected it will default to Global. When set to Shared identical values for all fixtures will default to shared. When set to Normal identical values will default to normal. This is useful where the automatic selection was not desirable, particularly in the case of global.

2. Master display refresh

The display refresh rate for masters has been increased for smoother UI feedback when adjusting a master level.

3. Highlight wheel select softkey

When wheel control is not level the softkey is now highlighted in blue to help make it clear which mode the wheels are in.

4. Patch view highlight during selection

Drag selecting fixtures in patch view while in the patch menu now highlights during selection so you can see exactly what you are selecting.

5. Set list re-run

Pressing the play button in a set list now restarts the current track including any macros, workspace shortcuts and page changes.

6. Button styling

Various buttons including softkeys, toggle switches, context menu and window appearance options have been restyled to make it clearer and easier to see when certain items have been selected/enabled or switched on/off etc. Where available, the window title bar context menu popup now also animates on opening.

7. Tooltips

Tooltip help prompts have been added to many of the touch options. Wherever available an 'i' inside a circle will be shown. Touching this or anywhere on the option title will reveal a popup with information about the particular setting. Touch again anywhere to close.

8. Reports include sub fixture cells

Previously patch reports showed all the cells of a multi-cell fixture which was unhelpful. Reports now only show the master fixture.

9. Numeric fields auto open keyboard

Editing numeric items such as fade times would cause the keyboard to auto open which was unnecessary given that numeric values can (and usually would) be input from the numeric pad. This has therefore been changed so that the keyboard no longer automatically opens for numeric fields.

10. Set cuelist notes from cell

It is now possible to input notes for a cuelist cue directly by touching the associated notes cell in playback view.

11. Cue linking options

When selecting link or link offset cells in cuelist playback view there are two new submenus to make setting the associated options easier.

12. Record tracking mode

It is now possible to set the tracking mode prior to recording via a softkey in the record menu.

13. TNP clock sync warning

The software will now prompt if the TNP clock sync has been lost. This would indicate there may be significant problems with the network.

14. Additional Programs

Icons and new options have been added to the Tools menu. Notably 'Log Viewer Pro' provides an easy way to get to the log viewer and 'TeamViewer' for remote assistance. Both options are for support.

15. Record master flashes available handles

When assigning masters the LED on available handles will now flash.

16. Patch to handle restrictions

It is now possible to patch fixtures on playback faders and executors.

17.1.4 Changes in v10.0

1. Open Workspace Window menu sorted alphabetically

The Open Workspace Window menu softkeys are now sorted alphabetically.

2. Master numeric entry

Numeric entry for all relevant masters is now restricted to the maximum level set for the particular master. If a value higher than the maximum is applied, the master will go to its maximum level. This is to avoid the issue where it would not be possible to regain fader control until a new value within the maximum range was set numerically or tapped (where appropriate).

3. Legacy Visualiser

With the integration of Capture the old Visualiser has been changed to 'Legacy Visualiser'.

4. Blind active/inactive softkey

On consoles with a physical Blind button holding this presented a blind active/inactive button on softkey A. This has now been removed as it was not required.

5. Autoload and Macro playback options

Autoload and Macro playback option softkeys for cuelists have been removed as they are only applicable to individual cues.

6. Removed wide/narrow button in channel grid context

The Wide/Narrow toggle option in the Channel Grid context menu was a legacy function and no longer had any effect. It has therefore been removed.

17.1.5 Bugs fixed in v10.0

1. Block shapes interfere with shapes fired on top

Previously if shapes with parameters on fader were fired after an active block all cue then fader actions on one of the shapes could affect the other unexpectedly. This has been resolved.

2. Timed flash on mode 2 or 3 shape playbacks snap out

Previously if a shape playback set to mode 2 or 3 was fired via timed flash it would delay for the fade value and then snap out after releasing the flash button. They now fade out over the specified time correctly.

3. Shapes get stuck after timed flash

Where a cue containing a shape had a release mask set and was fired via flash with times, the shape would continue after releasing the flash button. This has been resolved.

4. Cue release breaks release to home

Previously where a chase playback had a release mask and the cue release option was also enabled it would fail to release to home values. This has been fixed.

5. Intensity shape flash in cue list

Previously dimmer shapes in cuelists would not fire by flash. This has now been fixed.

6. Shape on sub fixture ignores selection pattern

Previously where a selection had been filtered by a pattern selection, shapes on sub fixtures would ignore the selection filter and apply to all fixtures originally selected. The shape now applies to the filter correctly.

7. Looped timecode fires disabled cues

Previously where cues in a cuelist were fired from timecode disabled cues would fire after the timecode looped. This has been fixed.

8. Autoload chase gets stuck

Where a cue autoloaded a chase and was linked with a subsequent cue where the linked offset was set to zero seconds the chase would never stop once fired. This has now been resolved.

9. Clear All Blind Playbacks not working

Previously, on consoles with a physical Blind button, holding this and selecting the [Clear All Blind Playbacks] did not work. This has now been fixed.

10. Invert doesn't update DMX

Previously if a dimmer was inverted and values were changed directly from 0 - 100% or vice-versa, the output would not update until nudged. This has now been resolved.

11. Wheels across ranges

Previously when transitioning from a fixed value to a range by wheel it was possible for the value to jump unexpectedly in certain situations. This has been resolved.

12. Global shape palette import

In certain circumstances imported global shape palettes wouldn't work. This has been fixed.

13. Handles disappear from show library when switching users and handle worlds

Fixed an issue where handles would disappear from the show library when switching users and handleworlds

14. Gaps in group layouts

When creating a group of cells a gap of empty spaces equivalent to the number of master fixtures would incorrectly be inserted into the group layout. This has now been fixed.

15. Filter relevant palettes delay after merge

Previously if you merged values into a palette that did not originally contain relevant controls, it would remain greyed out for a few seconds before showing as relevant. This now updates immediately.

16. Find Fixture corrupts output of patched fixtures

After using the Find Fixture function and turning it off, the output of patched fixtures would not restore correctly until values were nudged. DMX output is now refreshed correctly on exiting find fixture.

17. Find Fixture refresh after exchange

Previously find fixture would not locate fixtures following an exchange operation until it was toggled off/on. This has now been resolved.

18. Workspace doesn't extend when required

Fixed an issue where workspaces would not always extend to show all items when recalled from workspace shortcuts.

19. Rate grand master doesn't affect pixel map programmer

Fixed an issue where a rate grand master would not affect pixel map effects in the programmer.

20. Pixelmap autolocate

When creating a combination of pixel map and key frame shapes it was possible for the autolocate to turn off on the pixelmap fixtures. This has been resolved.

21. Off Playback Values results in empty playback view

Previously if you used the OFF/[Off Playback Values] function on a cuelist an empty playback view would open. The fully populated view now opens as expected.

22. Edit palette menu remains after quick record palette

Previously if you performed a quick record palette while in the edit palette menu the softkeys would be wrong. It now returns to the correct menu.

23. Key Frame Shape stuck after Clear All Programmers

After using the [Clear All Programmers] function while in record key frames mode it would appear to get stuck. Selecting Clear All Programmers will now exit the record key frames mode so that it is obvious you have deleted the shape.

24. Pixel map masters occupy DMX channels

In certain circumstances (usually when loading a show from an older version) if any pixel map masters were assigned they would show as occupying DMX channels preventing patching to these addresses. This has now been resolved.

25. Acn gateway loses settings

Previously the sACN gateway could lose settings if the network adapter was disconnected on startup. This has been resolved.

26. Console in backup hang

Resolved a rare issue where a console left in backup mode for a long time (approx 12 hours) could hang.

27. ProPlex Art-Net to DMX box crashes console

Previously with RDM enabled on a port connected to a Pro Plex Art-Net converter box, connecting an RDM fixture to one of the Pro Plex outputs would cause Titan to crash. This has been fixed.

28. Preload corrupts memory

In certain situations it was possible for memory to become corrupt when using preload in cuelists. This has now been resolved.

29. Fixture view attributes

Resolved an issue where it was not possible to set invert or freeze attributes from fixture view when using certain languages.

30. Multi user level match

Previously in multi-user sessions with consoles without motorised faders, fader level matching shared playbacks across consoles did not work correctly. This has been resolved.

31. Multiple shapes across multiple types

Fixed an issue where, with multiple fixture types in the programmer, it was not possible to adjust the spread of all shapes simultaneously.

18. Titan Commands quick reference

Please note that some commands may require [Enter] to complete the command. In this reference [Enter] has always been omitted for clarity.

[] means a physical key on the console.

<> means an item handle (playback handle or fixture handle)

The available keys may differ depending on which console you are using. Normally the function will be available as a macro if the key is not present on your specific console.

Some of the keys in this guide have changed names and so here is a list of the old key names and their new equivalents.

Old Name	New Name
Connect	Cue
SET	TIME

18.1.1 Fixtures

[Fixture] 1 [THRU] 10

Select fixtures 1 through to 10.

[Fixture] 1 [THRU] 10 [AND] 20 [AND] 25

Select fixtures 1 to 10 and 20, 25

[Fixture] 1 [THRU] 10 [AND] [.]2

Select the second cell of fixtures 1 to 10.

[Fixture] 1 [THRU] 10 [AND] [.]2

Select the second cell of fixtures 1 to 10.

[Fixture] 5 [@] [@]

Put fixture 5 at full intensity.

[Fixture] 1 [THRU] 60 [@] 75

Put fixtures 10 to 60 at 75% intensity.

[Group] 2 [@] [@]

Put group 2 at full intensity.

[Group] 2 [@] 75

Put group 2 at full intensity.

Celled Fixtures (Sub Fixtures)

[.] m

Select cell m in the selected fixtures.

[.]

Select all the cells in the selected fixtures.

n [.]

all sub fixtures of fixture n

1 [THRU] 5 [.] 2

Select the second cell of fixtures 1 to 5

[.] [THRO] [.] j

[THRO] [.] j

Select cells 1 to j of all selected fixtures

[.] m [THRO]

Cells m->last of all selected fixtures

[.] m [THRO] [.]j

[.] m [THRO] i

sub fixtures m->j or all selected fixtures

n [THRO] i[.]

all sub fixtures of fixtures n->i

n [THRO] i[.]j

sub fixture j of fixtures n->i

n [THRO] [.]j

sub fixture 1->j of fixture n

n [.] [THRO]

all sub fixtures of fixture n->last consecutive of type n

n [.] [THRO] i

sub fixtures 1->i of fixture n

n [.] [THRO] i[.]j

sub fixtures 1->j of fixtures n->i

18.1.2 Select If

[Select If] [Select If]

Select all fixtures above 0% intensity.

[Select If] [@] [THRU] 50

Select all fixtures above 50% intensity

[Select If] [@] 50 [THRU]

Select all fixtures below 50% intensity

18.1.3 Record

[Record] [Cue] [Cue]

Merge the live cue with the programmer.

[Record] [Cue] 90.1

Merge cue 90.1 with the programmer.

[Record] [Cue] 1 [Through] 10 [And] 20

Merge programmer contents into cues 1 to 10 and 20.

[Record] [Position] [Cue] [Cue]

Merge all but position from the programmer with the live cue.

[Record] [Options] [Position] [Cue] [Cue]

Merge only position from the programmer with the live cue.

18.1.4 Copy, Move

[Copy] [Cue] n

Copy cue n at the end of the cue list.

**[COPY/MOVE] <playback> 1 [THRO] 10 [NOT] 5 [AND] 20
[@] n**

**[COPY/MOVE] <playback> 1 [THRO] 10 [NOT] 5 [AND] 20
[ENTER] n [ENTER]**

Copy or move cues 1,2,3,4,6,7,8,9,10,20 and insert after cue n.

**[COPY/MOVE] <playback> 1 [THRO] 10 [NOT] 5 [AND] 20
[@] [@]**

**[COPY/MOVE] <playback> 1 [THRO] 10 [NOT] 5 [AND] 20
[ENTER] [ENTER]**

Copy or move cues 1,2,3,4,6,7,8,9,10,20 and insert at the end of the cue list.

**[COPY/MOVE] <playback> 1 [THRO] 10 [NOT] 5 [AND] 20
[@] <target playback> n**

**[COPY/MOVE] <playback> 1 [THRO] 10 [NOT] 5 [AND] 20
[ENTER] <target playback> n [ENTER]**

Copy or move cues 1,2,3,4,6,7,8,9,10,20 and insert at cue n in the target playback.

18.1.5 Delete

[Delete] [Cue] n

Delete cue n from the connected cue list.

18.1.6 Include

[Include] [Cue] n

Include cue n into the programmer from the connected cue list.

18.1.7 Times

[TIME] 5

5sec fade in

[CUE] 3 [TIME] 5

5sec fade in on connected playback's cue 3

[TIME] [FIXTURE] 5

5sec fade in for all attributes of selected fixtures

[TIME] [FIXTURE] [Gobo] 5

5sec fade in for gobo attribute group of selected fixtures

[TIME] [FIXTURE] [@] [B@] 5

5sec fade in for attribute connected to wheel B on selected fixtures

[TIME] 5 [@] 3

5sec fade in, 3 sec delay

[TIME] 5 [AND] 2

5sec fade in, 2sec fade out

[TIME] 1 [THRO] 10

times spread across fixtures according to selection order

18.1.8 Cue Lists

[Cue] n [Go]

Go to cue n

5 [Go]

Run the next cue with 5 sec fade instead of the programmed cue time

[Cue] 3 [Enter] 5 [Go]

Jump to cue 3 with 5 sec fade instead of the programmed cue time

19. Glossary of words

ADDRESSES	The DMX Channels occupied by individual Fixtures. The first Channel occupied is usually encoded onto the Fixture somehow (often by switches or using a menu) and called its ADDRESS.
ALIGN	A means of copying Attribute characteristics from the first Fixture selected to other selected Fixtures, resulting in the Fixtures being aligned to each other.
ATTRIBUTE	One Channel or function of an Intelligent Fixture, such as "Colour Wheel".
ATTRIBUTE GROUPS	see IPCGBES.
AUTOLOAD	A playback which is automatically fired by a cue in a cue list. Enables a chase to be fired by a cue list.
BACKUPS	Copies of a show stored to an external storage device for safety.
BPM	Beats Per Minute. 60 BPM is equivalent to one step per second.
BUSKING	Operating the console live (usually for live music) when you have insufficient programming and need to make up stunning effects as you go along using palettes etc.
CHASE	A sequence of one or more pre recorded steps which automatically run one after the other.
CHASE STEPS	Individual cues within a Chase. See above
COLOUR CHANGER	A mechanical Fixture for changing the colour of a light source, usually by scrolling through a roll of different coloured gels or by moving special filters into the light beam.
COLOUR MIX / CMY	A system of three filters that can each crossfade from white to a colour, or one colour to another. It is a feature of most Intelligent Fixtures, which enables thousands of different colours to be created.
CONNECTED CHASE	A Chase which has been brought under control of a chase Controller by pressing the CONNECT button.
CUE	A single stage look programmed onto a Playback button or fader. Also known as MEMORY, STATE, SCENE, LOOK.
CUE LIST	A sequence of cues programmed onto a Playback button or fader. Each cue can have its own delay and fade times and can also start other cues or playbacks. Also known as a CUE STACK or STACK.
CUE MODE	A playback format programmed into a Cue. There are Cue Modes 0 - 3.
DEVICE	See FIXTURE.

DIMMER	Device used to control the intensity of an individual light.
DMX	DMX512(1990) a specification for communication between control desks and Fixtures, Originally for Dimmers it has been adopted as a control protocol for most Intelligent Fixtures. It can carry 512 different Channels of data.
FADE	A continuous transition from one level to another.
FIXTURE	Any lighting instrument that is patched using a Personality. Generally refers to a moving light or colour changer, not an individual Dimmer channel. Also called Intelligent Fixture, Device, Instrument, Moving Light.
FLASH	Pushbutton which adds a playback into the existing output of the console. Historically called the ADD button. See also SWOP.
FLIP	A function for use with Moving Head Fixtures. They have two possible Pan and Tilt positions for each point on stage, and FLIP will alternate between them.
FOCUS	What Palettes used to be called on older Avolites consoles. See PALETTE. May also be used in connection with moving fixtures to focus (set the sharpness) of a gobo projection.
FUNCTION WHEEL	A wheel which does not directly control an Attribute channel on a fixture, rather it controls only part of an attribute and another function wheel may control other parts. For example a rotating gobo attribute may have one function wheel to control continuous or indexed mode, and another function wheel to control rotation speed or position, though the actual fixture only uses one DMX channel to control both these functions.
GENERIC	Term used to indicate a Dimmer channel. See also FIXTURE.
GROUP	A GROUP is a pre-programmed collection of Fixtures that can be selected with a single button press.
HTP	Highest Takes Precedence, a mechanism for determining the output level of a channel being controlled by more than one Playback. The Playback outputting the Highest value at any given time will determine the level of the channel. Also see LTP.
HUD	Heads-up-display, an information window shown on the screen.
INCLUDE	A means of transferring the contents of a Cue or Chase Step into the Programmer.
INSTRUMENT	See FIXTURE.
INTELLIGENT FIXTURE	See FIXTURE.
IPCBES	The Attribute Groups, used by the console to conveniently group together similar attributes. For

	example the P(osition) group includes Pan and Tilt attributes.
LCD	Refers to the console's on-board displays (stands for Liquid Crystal Display).
LED	Refers to the small lights within the buttons on the console (stands for Light Emitting Diode). Also a much brighter LED is used as the light source in some intelligent fixtures.
LINKS	Connections between cues in a Cue List or Chase enabling them to run on from one to another automatically.
LOCATE	A feature of the console that makes it easy to find your selected Fixtures by putting them in Open White. Pressing Shift+Locate additionally sets the Pan and Tilt at 50%.
LTP	Latest Takes Precedence, a mechanism for passing control of a channel from one Playback to another on the basis that the latest Playback Fader to be moved has control, providing that Playback Fader has moved past the Trigger point. (See TRIGGER POINT). Also see HTP.
MACROS	Macros allow functions programmed into an Intelligent Fixture by the manufacturer to be executed by sending a DMX command sequence from the console. They can allow you to reset the Fixture for example. The DMX command sequences are defined within the Personality File. Also used in Titan to refer to a stored sequence of button presses.
MEMORY	The name for a Cue on older Avolites consoles.
MIDI	Stands for Musical Instrument Digital Interface. It is the established hardware and software specification enabling the exchange of data between digital musical instruments (such as keyboards) and other devices such as computers, sequencers and sound and lighting consoles.
MENU LATCH	Provides functions for control of Moving Lights (Moving Light Menu).
ON and OFF	Any channel stored in a playback can be On or Off. A channel which is ON is changed by the playback when it is fired. A channel which is OFF is stored in the playback for future re-use but has no effect when the playback is fired.
OVERLAP	Sets how the console allocates new values to a group of fixtures. 100% means that all fixtures are updated simultaneously. 0% means that the fixtures will be updated one after the other.
PALETTE	A term used to describe a referenced pre-defined state for an Attribute that can be recalled whenever required during programming. Each Fixture may be set to a different value in the Palette, the entries can be named, and recalled with a single button press.

PARK	A Parked fixture is one which is patched to a handle but has no DMX address set. This happens to a fixture when its DMX address is taken by another fixture during a later patching session; the Repatch function is used to give it a new DMX address.
PERSONALITY	A description of what Attributes a particular Intelligent Fixture has and how the console will patch and use these. It also determines which Attribute Wheel will control which Attribute.
PLAYBACK	Area of the console that can replay recorded Cues or Chases using Playback Faders.
PRELOAD	A playback button which sets the LTP channels in a cue but not the HTP channels. Used to pre-position fixtures before firing a cue. Also a cue list function which allows one cue to preload the LTP channels in another cue.
PRESET FOCUS	The old name for Palettes on previous Avolites consoles. See PALETTE.
PROGRAMMER	The part of the console which contains Channel information which has been changed by the user, prior to recording.
SAFE	Desk mode in which all Playback functions are enabled, but all programming functions disabled.
SELECTED	A Fixture that is under manual control.
SEQUENCE	See CHASE.
SHAPE	A preprogrammed effect available which is applied to an Attribute. It can then be customised and stored in a Cue.
SHARED PALETTE	A Palette in which information is only stored for one Fixture, but is available to all Fixtures of that type.
SOFTKEY	Menu buttons marked A-J, which have different functions depending on the currently active menu.
STACK	Old name for a CUE LIST.
SWOP	Type of flash button which turns on the output being flashed and turns off all other output while the button is pressed. Sometimes called "Solo". Also used for selecting fixtures or playbacks when programming. See also FLASH.
TABLE	List of pre-defined levels for an attribute allowing settings to be recalled by name (for example the colours available from a colour wheel may be found in a table).
TIMECODE	An electronic timer signal which allows cue list playback to be synchronised to a soundtrack or other events. The console can read MIDI timecode or can take a timecode from the Windows sound player application "Winamp". An internal free-running timer is also provided.

TRACKING	Describes the operation of Cue Lists where lighting states follow through from previous cues unless changed by the user.
TRIGGER POINT	The level set in the User Settings which determines at which point a Playback Fader triggers the LTP Channels programmed onto it.
UNFOLD	A function that allows Chase Steps to be laid out onto Playback Faders for easy editing.
USER SETTINGS	User definable desk settings. To change them, hold down the Avo button and select [User Settings].
VIRTUAL DIMMER	Used with LED RGB (red-green-blue) colour mixing fixtures, these add an intensity function to the fixture which masters the RGB controls on the fixture when it does not actually have an intensity control channel.
WIPEALL	A process which clears all the previous programming out of the desk, but does not touch the System Software.
WHEEL	Wheels are used on the console to set Fixture Attributes and to control chases and cue lists (see FUNCTION WHEEL).

Index

Softkey Menu items are indicated with capital letters (for example "Activate A Timecode Cuelist")

@

@ button · 80

A

acceleration mode of wheels · 76
 ACDI, connecting up · 267
 active fixture
 media thumbnail · 79
 active fixtures · 269
 Add Swop button · 213
 adjust attribute values · 80
 Align fixtures · 84
 All button · 83
 always merge · 157
 Append · 175
 Append Cue (cue list) · 184
 Apply Time To Palette · 215
 Art-Net, setting up · 264
 As In · 196
 assign mastering · 234
 attribute editor window · 77
 attribute groups · 83
 attributes
 controlling · 75
 entering numerically · 80
 setting · 75, 76
 auto connect chase · 248
 auto groups · 54, 93
 auto legend · 100
 autoload playback in cue list · 186
 autoload times · 187
 autosave options · 46

B

backing up show · 46
 backup · 223
 banks of attributes buttons · 75
 Blind mode · 151
 blind to live · 214
 block effect, pixel mapper · 124
 block shape · 111
 Bunch Up · 66, 107, 162
 busking · 215
 buttons rows/columns · 29, 237

C

cells / sub fixtures · 74
 channel button · 81
 channel grid window · 89
 chases

appending new cues · 175
 connecting · 173
 cue linking · 180
 cue, fixture and attribute overlap · 178
 deleting · 162
 difference between chase and cue list · 183
 direction · 174
 editing using unfold function · 175
 global timing · 176
 individual cue times · 178
 inserting cues · 175
 pausing · 174
 recording · 171
 running · 172
 speed and crossfade · 173
 tap tempo · 177
 temporary speed · 173
 CITP · 269
 clear button · 73
 Clear button · 149
 clearing the console · 46
 colour picker · 77, 78
 compatibility view · 101, 238
 connect button · 173
 console legend · 40
 convert cue to cue list · 151
 copy chase · 176, 195
 copy cue · 161
 copy palette · 107
 copying
 fixtures · 66
 crossfade of chase · 173
 cue list
 append cue · 184
 attribute fade times · 197
 autoload · 186
 cue legends · 185
 default delay/fade times · 183
 difference between chase and cue list · 183
 editing cues and times · 193
 keyboard shortcuts · 187
 killing · 189
 macro link · 187
 move cues · 191
 move in dark · 190
 recording · 183
 setting times · 195
 update · 193
 Cue Overlap · 178, 197
 cue view · 158
 cues
 attribute fade times · 165, 179
 changing page · 153
 deleting · 162
 editing · 157
 fade modes · 164
 flashing · 152
 include function · 160
 playing back · 152
 recording · 150
 removing attributes · 160
 setting fade times · 162
 setting legends · 150
 curves · 251
 curves, fan · 86
 curves, fixture or attribute · 69

custom/user fixture personalities · 260

D

Delay Time · 164
 delete palette · 107
 deleting
 chase · 162
 cue · 162
 deleting patched fixtures · 66
 DHCP · 271
 dimmer shapes
 fading in · 126
 dimmer, virtual · 76
 dimmers
 entering numerically · 81
 patching · 50
 display setup · 234
 DMX address
 displaying for fixture · 51
 setting for fixture · 52
 DMX merge · 251
 DMX output mapping · 248
 DMX outputs · 23
 DMX Settings · 234
 DMX triggering · 219
 DMX workspace window · 61

E

Edit Times · 162
 editing a cue · 157
 editing values · 89
 Editor · 149
 effect editor, key frame shapes · 117
 effects generator · 111
 effects palette · 103
 enter numeric values · 80
 exchange mapping · 63
 external monitor · 239

F

fade curves · 251
 Fade Out Time · 164
 Fade Time · 164
 fade times for cues · 162
 fading palettes · 108
 fading palettes over time · 215
 Fan button · 85
 Fan curves · 86
 filter relevant palettes · 105
 filtered palettes · 105
 find fixture · 55
 firing a chase · 172
 fixture exchange · 62
 fixture layout · 93
 fixture macros · 95
 fixture offset · 68
 fixture order · 164, 198
 fixture order in a shape · 126
 Fixture Overlap · 164
 Fixture Overlap (chases) · 177, 198
 Fixture Overlap (cue lists) · 198
 fixture overlap (palettes) · 215
 fixture overlap with palettes · 108

fixture page buttons · 50
 fixture personalities, custom · 260
 fixture personalities, downloading and installing · 259
 fixtures
 changing page · 72
 groups · 92
 locating · 72
 patching · 51
 step through selection · 83
 Flash Full/Flash Out · 84
 flash with times · 213
 Flip · 85
 freeze fixture or attribute · 69

G

Generic fixtures · 261
 global chase timing · 176
 go and stop · 174
 Go button · 187
 go button for cues · 152
 group
 fixture layout · 93
 Group button · 92
 group masters · 212
 grouping fixtures · 92

H

halo colour for buttons · 29, 60
 handle · 49
 handle paging · 168
 handle worlds · 38
 headphone · 223
 HiLight button · 84
 HTP and LTP, explanation of · 152

I

import show · 44
 Include button · 160
 Insert (in unfold mode) · 192
 Insert (rec chase) · 175
 insert chase step · 175
 intensity window · 90
 Invert attributes · 67
 IP address, setting · 263
 IP addressing explained · 269
 IPCGBES groups · 83
 iPod/iPhone · 227

J

jump to step in chase · 174

K

key frame shapes · 116
 key profiles · 242
 keyboard not working · 36
 keyboard shortcuts · 36

L

latch menu · 31
 latching the copy menu · 162
 latching the rec cue menu · 150
 layer masters · 124
 LED brightness · 247
 legend button · 102
 legend, pictures · 102
 legends
 setting for fixtures/dimmers · 59
 legends for cues in cue list · 185
 level matching of playbacks · 153
 limiting attribute range · 68
 Link (cue lists) · 196
 Link Offset · 196
 Load Show · 43
 loading a show · 43
 Locate button · 72
 locate, record new state · 73
 lock playback on handle · 168
 lock the console · 36
 locking a playback across pages · 214
 LTP and HTP, explanation of · 152

M

macro in cue list · 187
 macros · 95
 macros (keypress) · 35
 mapping attributes on exchanged fixtures · 63
 mask
 clear · 73
 mask, recording cue · 151
 mask, toggle groups · 99
 master faders, assigning · 211
 master overlap (palette) · 109
 master palette overlap · 109
 master palette time · 109
 master time (palette) · 108
 master-slave linking · 39
 media servers, setting up · 269
 MIDI device ID · 248
 MIDI show control · 222
 MIDI sound to light · 222
 MIDI timecode options · 248
 MIDI triggering · 219
 mode 0 - 3 for cues · 164
 monitor · 239
 move chase · 176, 195
 move cue · 161
 move function · 216
 move in dark · 190
 move palette · 107
 moving cues in cue list · 191
 Moving fixture · 65
 Multi-DMX fixture · 261
 multiple dimmers on one handle · 51
 multi-user · 38, 223

N

nested palettes · 101
 network backup · 223
 New Show · 46

O

Off button · 160
 offset fixture attribute · 68
 offset, DMX patching · 53
 order of fixtures · 164

P

page
 selecting fixture pages · 50
 page buttons · 104
 page buttons, use in set list window · 217
 page legends · 60, 153
 page release · 155
 pages of cues · 153
 pages of fixtures · 72
 pages of palettes · 104
 pages show/hide button · 50
 palette
 auto legend · 100
 Palette Bank buttons · 104
 palette fade button · 109
 palettes · 97
 creating · 98
 editing and deleting · 106
 fading over time · 108, 215
 fixture overlap · 215
 master overlap · 109
 master time · 109
 recalling · 104
 setting legends · 102
 update · 106, 157
 viewing values · 105
 park fixture · 59
 patch view window · 56
 patching
 attribute limits · 68
 copying fixtures · 66
 curves · 69
 deleting fixtures · 66
 dimmers · 50
 edit personality · 70
 fixtures · 51
 freezing attributes · 69
 inverting attributes · 67
 setting legends · 59
 sub fixtures · 54
 swap pan and tilt · 67
 Patching, show DMX channels · 51
 pattern selection · 82
 pausing a chase · 174
 pearl expert shows · 238
 pending dimmer · 53
 personality, editing · 70
 phase of shapes · 115
 phase offset · 115
 picture legend · 102
 picture legends · 29
 pixel mapper · 121
 layer masters · 124
 pixel mapper examples · 127
 pixel mapper preview · 123
 playback blind mode · 167
 playback options
 chases · 179
 cues · 166
 playback paging · 245
 playback priority · 167
 playback view · 158
 playbacks
 releasing · 155

power on state · 156
 preset palettes · 54
 Prev/Next buttons · 83
 priority setting for playback · 167
 Programmer · 149
 prompt area · 34
 prompt for merge · 245

Q

Quick build · 172
 quick build cue · 150
 quick palettes · 105
 quick record · 28
 palette · 101

R

range of cues · 194
 RDM · 55
 Rec Step button · 193
 Rec Times button · 193
 Record (in unfold mode) · 175, 192
 Record Chase button · 171
 Record Cue button · 150
 recording macros · 35
 reinstalling software · 256
 release between cues · 181, 201
 release mask · 169
 release state · 156
 release to home · 155
 releasing playbacks · 155
 Rem Dim · 84
 remote control · 227
 remote trigger · 219
 remove fixtures from a shape · 126
 reports · 46
 resetting fixtures · 95
 Retain Layout · 66, 107, 162
 running a chase · 172

S

Save Show · 43
 saving show to hard disk · 42, 44
 Select a DMX line · 52
 Select Cue · 195
 Select Fix Page button · 72
 select if · 82
 selecting fixtures in a pattern · 82
 sessions view · 39
 Set Cue Times (in unfold mode) · 176
 Set Fixture Order · 198
 Set IPCGBES Times · 165, 179
 Set Legend button · 59, 150
 set list window · 216
 Set Out Time · 196
 setting attributes · 76
 Setup button · 42, 44
 shape behaviour · 120
 shape generator · 111
 shape palette · 103
 shape speed and size · 114
 shape tracking · 185
 shapes
 deleting · 126

 editing shape in a cue · 125
 fading in · 126
 fixture order · 126
 phase · 115
 reversing · 126
 shapes window · 112
 shortcut keys · 36
 show file
 saving and loading · 43
 show library · 44
 Show Library · 240
 showing cue list · 188
 simulator · 40
 Snap Back button (cue lists) · 188
 Snap button · 188
 software, recovery · 256
 software, upgrading · 255
 Speed (chase) · 177
 speed masters · 211
 speed of chase · 173
 speed/size masters · 154
 spread of shapes · 115
 Stop button (cue lists) · 188
 Store Palette · 98
 sub fixtures · 54
 sub fixtures, selection · 74
 swap fixture addresses · 58
 swap items if required · 66, 107, 162
 Swap Pan Tilt · 67
 system menu · 233

T

tap tempo · 177
 tap tempo, rate masters · 154
 tempo units · 246
 temporary chase speed · 246
 temporary speed · 173
 text size · 245
 theatre mode · 183
 timecode · 199
 times, setting into programmer · 166
 Titan simulator · 40
 TitanNet overview · 250
 toggle mask · 99
 touch button size · 245
 transparent lock · 168, 214
 Triggers · 234

U

unassign · 162
 undo/redo · 34
 unfold
 cue list · 192
 Unfold button · 175
 Unknown fixtures · 261
 unlinking chase cues · 178
 update · 106, 157, 193
 update mode · 194
 update personalities · 65
 upgrading the software · 255
 UPS · 22
 user number · 51
 user settings menu · 233, 244

V

VDU · 239
view DMX output · 61
view effects · 106
view if, intensity window · 91
view menu · 216
view shapes · 106
viewing key profiles · 242
virtual dimmer · 76
Visualiser · 34
Visualiser auto patch · 54

W

warn before parking fixtures · 245
Wheel sensitivity · 248

wheels
 acceleration · 76
 controlling attributes · 75
 fast mode · 76
wheels= softkey · 88
window positions · 26, 27, 234
wings, connecting · 24
Wipe · 233
wipeall · 46
workspace
 positioning windows · 26, 234
 saving · 28, 237
 window options · 27

X

X in fixture order · 165

Avolites Titan Operator's Manual (Quartz version)

part number **8200-4000**

Price £30

Additional copies of this manual, together with other useful spares etc. can be purchased through the Avolites On line shop. Visit <http://www.avolites.com> then navigate to Avo Shop from the links on the left hand side.