

TASCAM

Sonicview 16

Sonicview 24

Digital Mixer

REFERENCE MANUAL

V1.3.0

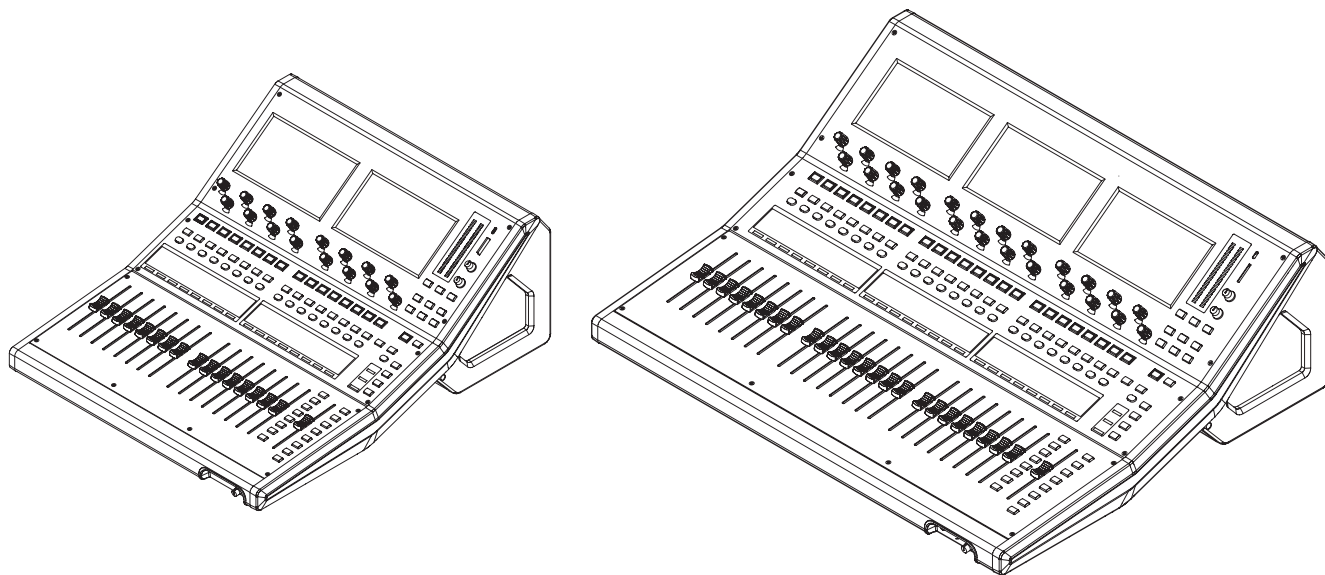

Contents

| | | | |
|--|-----------|--|------------|
| 1 – Introduction | 5 | Notes about Dante | 90 |
| Overview | 5 | Connecting to a Dante network | 90 |
| Conventions used in this manual | 5 | Using Dante Controller | 91 |
| Trademarks and copyrights | 6 | SLOT SETUP screen | 92 |
| Features | 7 | When an IF-DA64 (Dante) card is installed | 92 |
| Main features | 7 | When an IF-AE16 (AES/EBU) card is installed | 93 |
| Main specifications | 7 | When an IF-MA64/EX or IF-MA64/BN (MADI) card is installed | 93 |
| 2 – Names and Functions of Parts | 8 | When an IF-AN16/OUT (analog output) card is installed .. | 94 |
| Top panel | 8 | When an IF-MTR32 (multitrack recording) card is installed | 94 |
| Front panel | 12 | Network Setup screen | 95 |
| Rear panel | 13 | Saving the current settings | 97 |
| GPIO connector overview | 15 | 5 – Routing | 98 |
| Basic unit operations | 16 | Input routing | 98 |
| Home Screen | 17 | Setting input sources for multiple channels at the same time in blocks | 100 |
| CH 1–40 Module Home Screen | 17 | Setting inputs sources for multiple channels at the same time in batches | 100 |
| ST IN 1–2/FX RTN 1–4 Module Home Screen | 21 | Direct out signal output routing | 101 |
| MIX 1–22 and MAIN L/R Master Module Home Screen | 24 | Insert input and output routing | 102 |
| DCA Module Home Screen | 28 | Output routing | 103 |
| Menu Screen | 29 | Setting output ports for multiple channels at the same time | 105 |
| Menu Screen operations | 29 | Setting output ports for multiple channels at the same time in batches | 106 |
| Menu structure | 30 | INPUT SOURCE SELECT screen | 106 |
| 3 – Preparation | 32 | DIRECT OUT PORT SELECT screen | 108 |
| Installing expansion cards (sold separately) | 32 | INSERT SEND PORT SELECT screen | 110 |
| Turning the power on and off | 32 | INSERT RETURN PORT SELECT screen | 111 |
| Setting the built-in clock date and time | 33 | OUTPUT PORT SELECT screen | 112 |
| Connecting and disconnecting SD cards and USB flash drives | 33 | 6 – Modules | 114 |
| SD card write protection switches | 33 | MODULE Screen | 114 |
| Preparing SD cards and USB flash drives for use | 33 | MODULE Screen overview | 114 |
| 4 – Mixer configuration and settings | 34 | MODULE (OVERVIEW) Screen | 116 |
| SYNC CLOCK screen | 34 | CH 1–40 MODULE (OVERVIEW) Screens | 116 |
| Setting the sampling frequency | 35 | ST IN 1–2 MODULE (OVERVIEW) Screens | 121 |
| Setting the master clock | 35 | FX RTN 1–4 MODULE (OVERVIEW) Screens | 124 |
| PREFERENCES screen | 36 | MIX 1–22 and MAIN L/R Master MODULE (OVERVIEW) Screens | 125 |
| METER screen | 38 | MODULE (INPUT) Screen | 128 |
| METER SETUP screen | 40 | Setting digital trim values in batches | 132 |
| METERING POINT page | 40 | MODULE (FX) Screen | 132 |
| METER HEADROOM page | 40 | Effect parameters | 133 |
| LOCK SETUP screen | 41 | MODULE (GATE/EXPANDER/DE-ESSER) screens | 136 |
| MIXER CONFIG screen | 42 | Dynamics parameters | 137 |
| CH 1–40 CONFIG page | 42 | MODULE (EQ) Screen | 138 |
| BUS CONFIG page | 43 | MODULE (GEQ) Screen | 140 |
| USER DEFINED CONTROLS screen | 44 | MODULE (COMP/DUCKER) Screen | 142 |
| USER DEFINED CONTROLS screen structure | 51 | Dynamics parameters | 143 |
| User Key page | 52 | KEY IN SOURCE SELECT screen | 144 |
| Foot Switch page | 53 | MODULE (SEND/PAN) Screen | 144 |
| GPIO-IN page | 53 | MODULE (OUTPUT) Screen | 148 |
| GPIO-OUT page | 54 | MODULE menu | 150 |
| Fader Start Level setting | 54 | | |
| Layer Key SETUP page | 55 | | |
| Custom Layer SETUP page | 56 | | |
| Custom layer assignment operation procedures | 58 | | |
| Making monitor output and solo function settings | 59 | | |
| MONITOR SOURCE ASSIGN screen | 61 | | |
| Making talkback and built-in oscillator settings | 62 | | |
| Dante SETUP screen | 63 | | |
| Dante Settings page | 63 | | |
| I/O Device page | 64 | | |
| Using SB-16D units | 66 | | |
| SB-16D control | 74 | | |
| Using GPIO extension functions | 83 | | |
| Procedures for Dante connection with SB-16Ds | 84 | | |

| | |
|--|------------|
| 7 – Other module parameter setting screens..... | 152 |
| SENDS ON FADER function..... | 152 |
| SENDS ON FADER screen..... | 152 |
| SEND OVERVIEW screen..... | 153 |
| MIX 1–22 bus SEND OVERVIEW Screen..... | 153 |
| FX 1–4 bus SEND OVERVIEW Screen..... | 156 |
| MAIN L/R bus SEND OVERVIEW Screen..... | 158 |
| SEND OVERVIEW menu..... | 161 |
| Mute Group and DCA functions..... | 163 |
| Mute Group function..... | 163 |
| DCA (Digital Control Amplifier) functions..... | 163 |
| DCA/Mute Group SETUP screen..... | 163 |
| DCA Assign page..... | 163 |
| Mute Group Assign page..... | 164 |
| Mute Group Master page..... | 165 |
| MODULE NAME screen..... | 166 |
| Setting and editing user module names..... | 167 |
| Changing set module colors..... | 168 |
| Setting module icons..... | 169 |
| 8 – Saving and recalling setting data..... | 170 |
| Snapshot functions..... | 170 |
| Using snapshot functions at the top of the Menu Screen.. | 170 |
| Storing snapshots..... | 171 |
| Recalling snapshots..... | 172 |
| Snapshot List Screen..... | 174 |
| Library menu..... | 176 |
| Copying snapshots..... | 177 |
| SNAPSHOT RECALL SAFE screen..... | 178 |
| PARAMETER SAFE page..... | 178 |
| MODULE SAFE page..... | 178 |
| SNAPSHOT IMPORT / EXPORT screen..... | 179 |
| Exporting snapshots..... | 180 |
| Importing snapshots..... | 180 |
| Various LIBRARY Screens..... | 182 |
| LIBRARY screen overview..... | 183 |
| MODULE RECALL SAFE screens..... | 185 |
| All System Data screen..... | 186 |
| Saving All System Data..... | 187 |
| Loading All System Data..... | 187 |
| Backing up All System Data..... | 188 |
| Restoring All System Data..... | 189 |
| 9 – Various information displays..... | 192 |
| INFORMATION Screen..... | 192 |
| STATUS page..... | 192 |
| ERROR page..... | 193 |
| Error/alert message display..... | 194 |
| OPEN SOURCE SOFTWARE LICENSE Screen..... | 195 |
| Sonicview 16/24 Error Screen..... | 196 |
| SYSTEM error/alert message list..... | 196 |
| Media Manage Screen..... | 200 |
| Formatting media..... | 200 |
| Version Information Screen..... | 201 |
| Firmware update procedures..... | 201 |
| 10 – Recording and playback..... | 204 |
| RECORDER/PLAYER Screen..... | 204 |
| RECORDER Section..... | 204 |
| PLAYER Section..... | 205 |
| BROWSE Screen..... | 206 |
| BROWSE Screen for recording folder selection..... | 206 |
| BROWSE screen for playback media, folder and file selection..... | 208 |
| Setting the recording folder..... | 211 |
| Setting the playback folder..... | 211 |
| 11 – USB audio interface functions..... | 212 |
| Installing the dedicated software..... | 212 |
| Installing the Windows dedicated software..... | 212 |
| Uninstalling the dedicated software..... | 213 |
| Uninstalling the Windows dedicated software..... | 213 |
| Opening the dedicated software..... | 213 |
| Windows..... | 213 |
| Input latency..... | 213 |
| Setting Sound Properties..... | 213 |
| Simultaneous ASIO/WDM playback..... | 214 |
| Setting procedures for use with OBS Studio and other streaming applications..... | 214 |
| 12 – Multitrack Recorder..... | 216 |
| Maximum recording time..... | 216 |
| Formatting SD cards..... | 216 |
| Projects and takes..... | 216 |
| MTR operation modes..... | 216 |
| MULTI TRACK RECORDER Screen..... | 217 |
| Using the AUTO ROUTING function..... | 222 |
| Switching MTR operation mode..... | 224 |
| REC READY/INPUT MONITOR settings..... | 225 |
| MULTI TRACK RECORDER - MENU Screen..... | 227 |
| MULTI TRACK RECORDER - BROWSE Screen..... | 229 |
| Folder structure overview..... | 230 |
| Folder structure..... | 230 |
| Recording file names..... | 230 |
| File format overview..... | 230 |
| Managing projects..... | 231 |
| Viewing project and take lists..... | 231 |
| Project operations..... | 231 |
| Creating new projects..... | 231 |
| Selecting projects..... | 232 |
| Deleting projects..... | 232 |
| Changing project names..... | 232 |
| Basic recording..... | 233 |
| Selecting the MTR input source..... | 233 |
| Recording..... | 234 |
| Checking recorded audio (playing recordings)..... | 234 |
| Recorder functions..... | 235 |
| Locate function..... | 235 |
| Repeat playback function..... | 235 |
| Automatic recording function..... | 236 |
| Pre-recording function..... | 236 |
| Punch in/out function..... | 237 |
| Automatic punch in/out function..... | 237 |
| Undoing auto punch in/out operations (UNDO function)..... | 239 |
| Editing takes..... | 239 |
| Changing take names..... | 239 |
| Deleting takes..... | 240 |
| Importing files that have been recorded on other devices..... | 240 |
| File name format..... | 240 |
| Preparation before Importing..... | 241 |
| Using imported files with this unit..... | 241 |
| Mark function..... | 241 |
| Adding marks..... | 241 |
| Moving between marks..... | 242 |
| Clearing individual marks..... | 242 |

Contents

| | |
|--|------------|
| 13 – List of shortcut operations..... | 244 |
| 14 – Troubleshooting | 245 |
| 15 – Specifications and ratings..... | 247 |
| Internal processing..... | 247 |
| Audio performance..... | 248 |
| Analog audio input and output ratings..... | 248 |
| Digital audio input/output ratings..... | 249 |
| Control input/output ratings..... | 249 |
| Other input and output specifications | 249 |
| Recorder specifications..... | 249 |
| Operating system and computer requirements..... | 250 |
| Windows..... | 250 |
| Mac..... | 250 |
| Other | 250 |
| Dimensional drawings..... | 250 |
| 16 – Block diagram | 251 |
| 17 – Parameter tables..... | 252 |
| Sonicview 16/24 Mixer Basic Parameters..... | 252 |
| Sonicview 16/24 Mixer Basic Parameters (FX)..... | 257 |
| Sonicview 16/24 Preset List | 260 |

Overview

The Sonicview 16 has 2 touchscreens and 16 channels of mic preamps while the Sonicview 24 has 3 touchscreens and 24 mic preamps. Both digital mixer models have 44 input channels and 24 buses along with Dante and audio interface functions.

Main features

- Two 7-inch touchscreens (Sonicview 16)
- Three 7-inch touchscreens (Sonicview 24)
- 96kHz 54-bit float FPGA hardware mixing engine
- Super low latency: 20.8µsec/2-sample mixing engine latency, 0.51ms analog to analog latency
- 96kHz/32-bit ADC HDIA mic preamps
- 44 input channels/22 flexible buses and a MAIN L/R bus (all with 31-band GEQ)/4 loop-type FX buses
- 16 XLR mic/line inputs (+32dBu maximum input) (Sonicview 16)
- 24 XLR mic/line inputs (+32dBu maximum input) (Sonicview 24)
- 16 XLR line outputs
- Built-in 64-in/64-out Dante interface (supports redundancy)
- 2 TASCAM slots support MADI, AES/EBU, analog out and Dante cards (sold separately)
- 32-bit, 32-in/32-out USB audio interface
- 8 TRS line inputs (channels 9–16 on Sonicview 16 and channels 17–24 on Sonicview 24)
- 2 inserts (channels 7–8 on Sonicview 16 and channels 15–16 on Sonicview 24)
- 2 RCA stereo input (ST IN) pairs
- XLR talkback input
- XLR monitor output
- 2 headphone outputs: 6.3mm (1/4") and 3.5mm (1/8")
- 16+1 100mm motorized feeders (Sonicview 16)
- 24+1 100mm motorized feeders (Sonicview 24)
- Remote control and off-line editing possible using the dedicated TASCAM Sonicview Control app (macOS, Windows and iPadOS)
- High stability with completely separated mixing engine and control surfaces in both hardware and OS
- Libraries: Snapshot, Module, Effect, EQ, GEQ, Gate, Comp
- 18 assignable USER KEYS, 7 custom layers, module-assignable MASTER section and 8 DCAs
- 16/24 rotary encoders with color LEDs
- 16/24 channel name LCDs with color LEDs (these also support display of input level meters and gain reduction meters)
- Stereo recording (SD cards) and stereo playback (SD cards and USB flash drives)
- Word in/out/thru
- 1000BASE-T Gigabit Ethernet
- 8-in/8-out GPIO
- TS footswitch
- XLR-4-31 lamp jack
- Power switch with guard

Conventions used in this manual

In this manual, we use the following conventions:

- This unit has two types of buttons that can be operated: physical buttons on the top panel and buttons that appear on the touchscreen. The buttons on the top panel are identified as keys, for example, the "MUTE key".
- The sets of 8 knobs beneath the touchscreens are called "LCD knobs" and are identified from left to right as LCD knob 1 – LCD knob 8.
- SDHC/SDXC memory cards are referred to as "SD cards".
- The following modules that handle stereo signals are called "stereo modules":
 - CH 1–40 modules when the stereo link setting is on
 - MIX 1–22 modules when the stereo link setting is on
 - ST IN 1–2 module
 - FX RTN 1–4 module
 - MAIN L/R Master module
- The last snapshot that was stored or recalled is called the "current snapshot".
- Additional information is introduced in the styles below when needed:

TIP

These are tips about how to use the unit.

NOTE

These provide additional explanations and describe special cases.

ATTENTION

Failure to follow these instructions could result in damage to equipment or lost data, for example.

CAUTION

Failure to follow these instructions could result in injury.

1 – Introduction

Trademarks and copyrights

- TASCAM is a registered trademark of TEAC Corporation.
- SDXC Logo is a trademark of SD-3C, LLC.



- VST is a trademark of Steinberg Media Technologies GmbH, registered in Europe and other countries.



- Microsoft, Windows and Windows Media are either registered trademarks or trademarks of Microsoft Corporation in the United States and/or other countries.
- Apple, Mac, macOS, iPad, iPadOS and iTunes are trademarks of Apple Inc. in the United States and other countries.
- etherCON is a registered trademark of Neutrik AG.
- Audinate®, the Audinate logo and Dante are trademarks of Audinate Pty Ltd.
www.audinate.com/patents
- ASIO is a trademark of Steinberg Media Technologies GmbH.



- Other company names, product names and logos in this document are the trademarks or registered trademarks of their respective owners.

Information is given about products in this manual only for the purpose of example and does not indicate any guarantees against infringements of third-party intellectual property rights and other rights related to them. TEAC Corporation will bear no responsibility for infringements on third-party intellectual property rights or other liabilities that occur as a result of the use of this product.

Properties copyrighted by third parties cannot be used for any purpose other than personal enjoyment and the like without the permission of the right holders recognized by copyright law. Always use this equipment properly. TEAC Corporation will bear no responsibility for rights infringements committed by users of this product.

Features

Main features

Each 8-channel module has a touchscreen with 8 LCD knobs, enabling intuitive operation of various parameters for each channel allowing simultaneous monitoring and status.

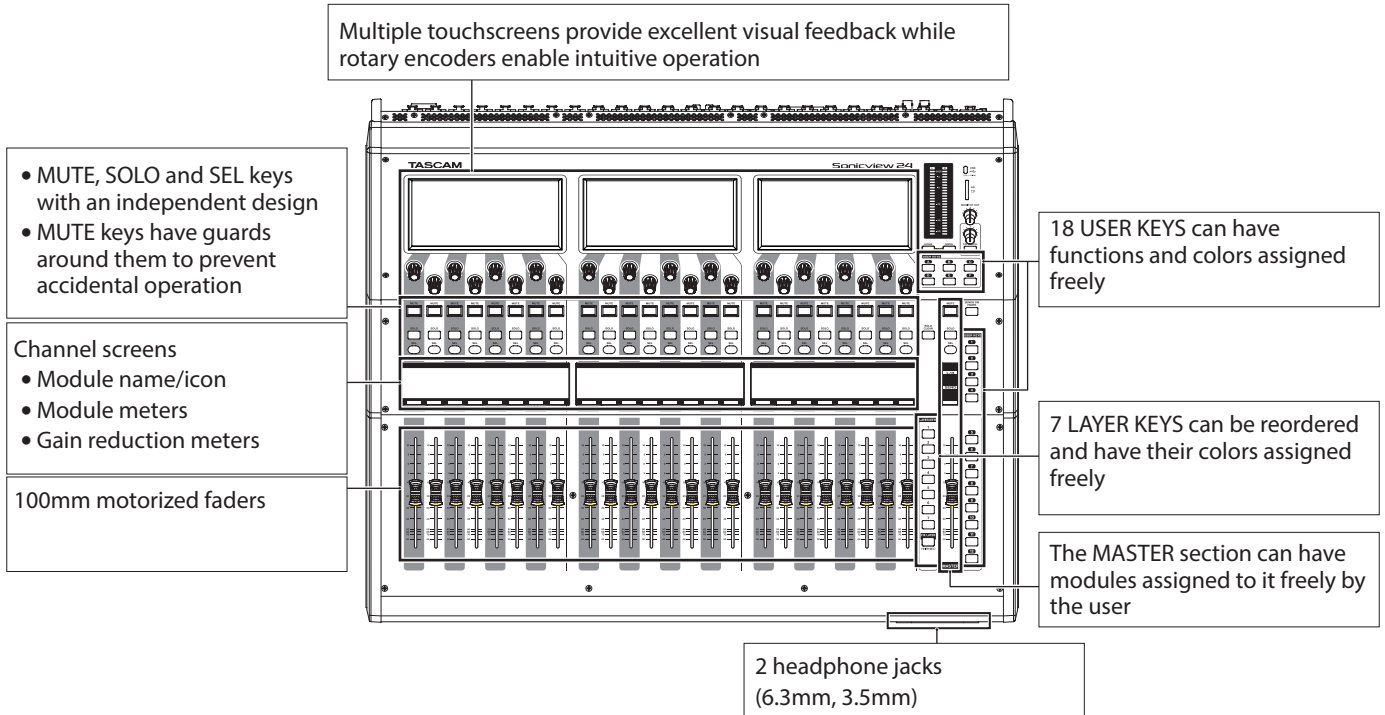

Main specifications

Simultaneous processing capabilities

- Input: 40 mono channels and 2 stereo channels
- Output buses: 22 switchable AUX/GROUP buses and a stereo main bus
- 4 internal effects, 4 effect send buses, and 4 stereo effect return channels

Input and output ports

- 16 or 24 mic/line inputs
- 2 stereo RCA inputs
- 16 analog line outputs
- Stereo analog monitor outputs
- Dante I/O that supports redundancy
- 2 expansion slots
- 32-in/32-out USB audio interface port

Internal processing

- 96kHz/54-bit floating-point arithmetic

2 – Names and Functions of Parts

Top panel

This section explains the displays and controls on the top panel.

NOTE

The various buttons that have indicators remain dimly lit even when off, making them easier to see and use even in dark situations.

Channel section

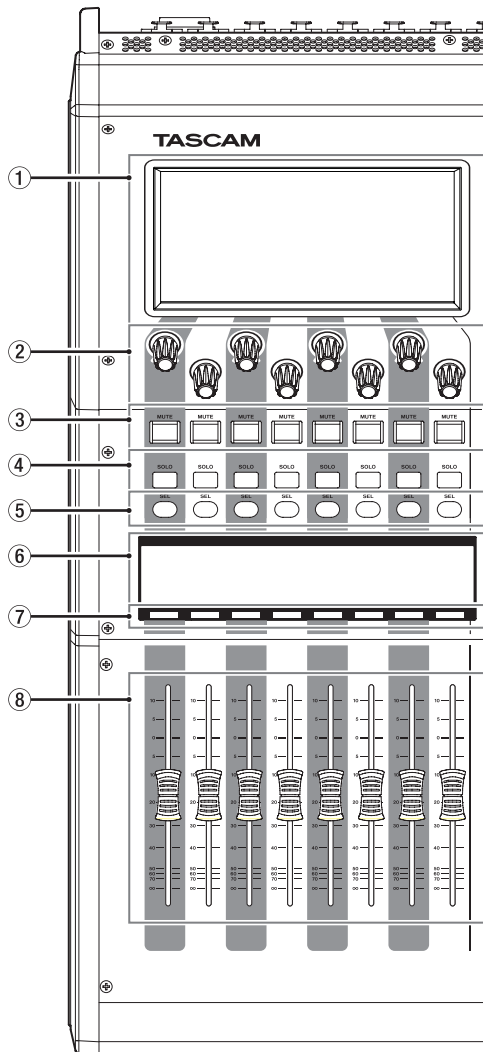

Master section

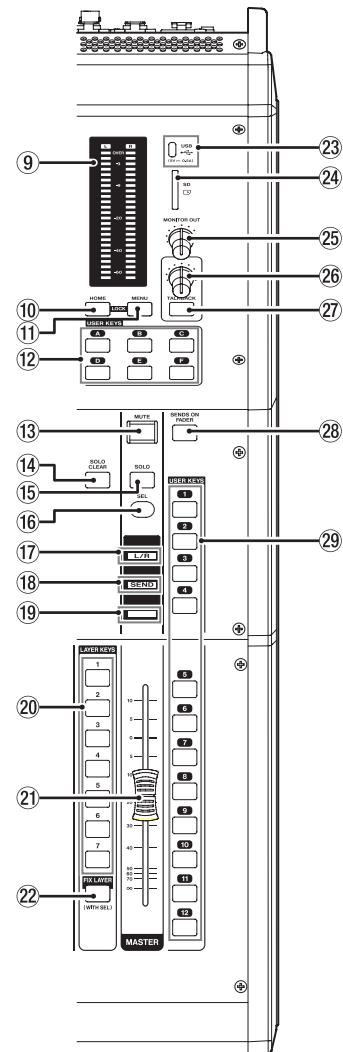

① Touchscreen

- Resistive-type (pressure-sensitive) 800×480 LCD color touch panels.
- Shows a variety of information.
- Tap and swipe the screens being shown to operate them.
- Only one point on one screen can be operated at a time.
- Set the brightness on the PREFERENCES Screen. (See "PREFERENCES screen" on page 36.)

② LCD knobs and indicators

- When LCD knobs can be used to control items shown on the touchscreen, their indicators light.
- Turn those LCD knobs to adjust various parameters shown on the touchscreen.

NOTE

• Parameter adjustment with LCD knobs

- Turning an LCD knob without pressing it will change the parameter value by one step with each click. This enables precise parameter adjustment.
- When adjusting a parameter with high resolution, turning an LCD knob while pressing it will change the parameter value by multiple steps with each click. This enables efficient parameter adjustment.
- By turning any LCD knob while pressing the HOME key, the brightness of the touchscreens, channel screens, various indicators and the lamp connected to the LAMP connector on the rear panel can all be adjusted at the same time.
- By pressing and turning any LCD knob while pressing the HOME key, the brightness of the touchscreens and channel screens can be adjusted at the same time.
- By turning an LCD knob while pressing the MENU key, the contrast of the channel screen that corresponds to that knob can be adjusted. (See "13 – List of shortcut operations" on

2 – Names and Functions of Parts

page 244.)

③ MUTE keys and indicators

- These mute/unmute modules assigned to the selected layer.
- When a MUTE key is on (lit), the signal of the corresponding module is muted.
- Depending on the DCA or Mute Group, the key will blink when muted.
- When the SENDS ON FADER key is on (Sends On Fader mode is on), these turn sends on/off to the selected bus from the modules assigned to the selected layer (send off when MUTE key lit, send on when MUTE key unlit). For modules that do not have a send on/off function for the subject bus, however, these mute/unmute the corresponding module. (For example, this applies when the subject bus is FX1 and the module is FXRTN1 or the subject bus is MIX1 and the module is MIX1.)

④ SOLO keys and indicators

- These turn soloing on/off for modules assigned to the selected layer.
- When these keys are on (lit), the signals of the corresponding modules will be sent to the SOLO L/R bus.
- The keys will blink if soloing is on because of DCA.

NOTE

The MONITOR SETUP screen MONITOR/SOLO page, which is where various solo settings can be made, can be opened by pressing this key while pressing the MENU key. (See “Making monitor output and solo function settings” on page 59 and “13 – List of shortcut operations” on page 244.)

⑤ SEL keys and indicators

- Press these keys to open the MODULE Screens for modules assigned to the selected layer. The corresponding keys light. If the MODULE Screen shown for a module has been changed on the touchscreen, the corresponding SEL key will light.
- When a lit SEL key is pressed, the MODULE screen for that module will be shown on the touchscreen that corresponds to that SEL key if it is not already shown. If the MODULE screen for that module is shown on the touchscreen that corresponds to that SEL key, it will close and the SEL key will become unlit.

NOTE

Pressing one of these keys while pressing the HOME key will set the fader level for the corresponding module to 0 dB. (When Sends On Fader mode is on, the SEND level will be set instead.) (See “13 – List of shortcut operations” on page 244.)

⑥ Channel screen

- These show the following information for modules assigned to the selected layer.

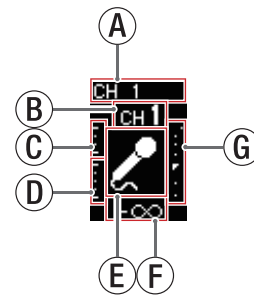

- Ⓐ Module name
- Ⓑ User module name (name set by user)*
- Ⓒ GATE/EXP/DE-ESSER gain reduction meter
- Ⓓ COMP/DUCKER gain reduction meter
- Ⓔ Module icon*
- Ⓕ Fader level value
- Ⓖ Module meter (shows signal level of set metering point)

- If the module is stereo, a stereo module meter will be shown.
- Each module meter has an overload indicator at its top. They will light when the signal level reaches or exceeds -0.00026 dBFS (16-bit full-scale value).
- The area below -60 dBFS at the bottom of the module meters will light when above -70 dBFS.

* See “MODULE NAME screen” on page 166 for details about setting user module names and module icons.

- When the SENDS ON FADER key is on (Sends On Fader mode is on), the black and white display is inverted and “SEND to [bus name]” will be shown on a black band at the bottom of the screen.

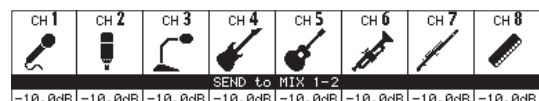

- When the FIX LAYER key (Ⓢ) has been used to lock 8 channels to the layer, “FIXED LAYER” will be shown on a white band at the top of the screen.

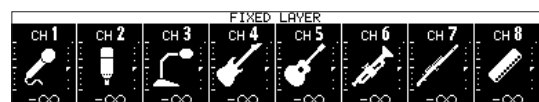

- When the Sends On Fader mode is on and 8 channels have been locked to the layer, the black and white display will be inverted and “SEND to [bus name]” and FIXED LAYER” will be shown on a black band at the bottom of the screen.

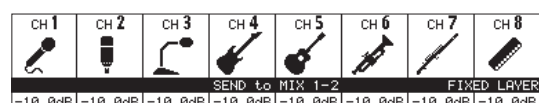

- Use the PREFERENCES Screen to set the brightness and contrast of the channel screens. (See “PREFERENCES screen” on page 36.)

2 – Names and Functions of Parts

⑦ Channel color bars

These show the colors set for the modules assigned to the selected layer. (See “Changing set module colors” on page 168.)

⑧ Channel faders

- When the SENDS ON FADER key is off (Sends On Fader mode is off), these adjust the fader levels for the modules assigned to the selected layer.
- When the SENDS ON FADER key is on (Sends On Fader mode is on), these adjust the send levels to the selected bus for the modules assigned to the selected layer.

⑨ Output meters

These are output meters for the MAIN L/R bus. The OVER indicators light red when they reach or exceed -0.00026 dBFS (16-bit full-scale value). The bottommost indicator lights when above -70 dBFS.

⑩ HOME key

- When the Menu Screen or a settings screen is open, press to return to the Home Screen on all touchscreens.
- Press and hold this key and the MENU key together for 5 seconds to open the LOCK SETUP screen. (See “LOCK SETUP screen” on page 41.)

NOTE

Various shortcut operations are possible using this key in combination with others. See “13 – List of shortcut operations” on page 244 for details.

⑪ MENU key

- Press this key to open the Menu Screen on the right touchscreen.
- Press and hold this key and the HOME key together for 5 seconds to open the LOCK SETUP screen. (See “LOCK SETUP screen” on page 41.)

NOTE

Various shortcut operations are possible using this key in combination with others. See “13 – List of shortcut operations” on page 244 for details.

⑫ USER KEY A–F and indicators

Users can assign functions and colors to these keys as they like. When functions that have different statuses are assigned to these keys, they will light, blink and become unlit accordingly. (See “USER DEFINED CONTROLS screen” on page 44.)

NOTE

Press one of these keys while pressing the MENU key to open the screen that corresponds to its assigned function. (See “13 – List of shortcut operations” on page 244.)

⑬ MUTE key and indicator (MASTER)

- This mute/unmutes.
- When the SENDS ON FADER is off (Sends On Fader mode is off), this mutes the module assigned to the MASTER slot on the Custom Layer Setup page of the Layer Key Setup Screen (MAIN L/R by default).
- When the SENDS ON FADER key is on (Sends On Fader mode is on), this mutes the selected bus master module.
- When a MUTE key is on (lit), the signal of the corresponding module is muted.
- Depending on the DCA or Mute Group, the key will blink when muted.

⑭ SOLO CLEAR key and indicator

- The SOLO CLEAR indicator lights when any module is being soloed.
- Press this when the SOLO CLEAR indicator is lit to end soloing of all channels.

NOTE

The MONITOR SETUP screen MONITOR/SOLO page can be opened by pressing this key while pressing the MENU key. (See “Making monitor output and solo function settings” on page 59 and “13 – List of shortcut operations” on page 244.)

⑮ SOLO key and indicator (MASTER)

- This turns soloing on and off.
- When the SENDS ON FADER is off (Sends On Fader mode is off), this solos the module assigned to the MASTER slot on the Custom Layer Setup page of the Layer Key Setup Screen (MAIN L/R by default).
- When the SENDS ON FADER key is on (Sends On Fader mode is on), this solos the selected bus master module.
- When this key is on (lit), the signal of the corresponding module is sent to the SOLO L/R bus.
- The key will blink if soloing is on because of DCA.

NOTE

The MONITOR SETUP screen MONITOR/SOLO page, which is where various solo settings can be made, can be opened by pressing this key while pressing the MENU key. (See “Making monitor output and solo function settings” on page 59 and “13 – List of shortcut operations” on page 244.)

2 – Names and Functions of Parts

⑩ SEL key and indicator (MASTER)

- When the SENDS ON FADER is off (Sends On Fader mode is off), this functions as the SEL key for the module assigned to the MASTER slot on the Custom Layer Setup page of the Layer Key Setup Screen (MAIN L/R by default).
- When the SENDS ON FADER key is on (Sends On Fader mode is on), this functions as the SEL key for the selected bus master module.
- Press this key, lighting it, to open the MODULE screen for the assigned module on the right touchscreen. If the MODULE Screen shown for a module has been changed on the touchscreen, the corresponding SEL key will light.
- When a lit SEL key is pressed, the MODULE screen for the that module will be shown on the touchscreen that corresponds to that SEL key if it is not already shown. If the MODULE screen for that module is shown on the touchscreen that corresponds to that SEL key, it will close and the SEL key will become unlit.

NOTE

Pressing this key while pressing the HOME key will set the fader/send level for the corresponding module to 0 dB. (See “13 – List of shortcut operations” on page 244.)

⑪ L/R indicator

- When the SENDS ON FADER key is off (Sends On Fader mode is off) and MAIN L/R is the module assigned to the MASTER slot on the Custom Layer Setup page of the Layer Key Setup Screen, the MUTE, SOLO and SEL keys, the color bar and the MASTER fader in the top panel master section will control/display the MAIN L/R Master module, and the indicator will light.
- This indicator will be unlit when the SENDS ON FADER key is on (Sends On Fader mode is on), as well as when the SENDS ON FADER key is off and MAIN L/R is not the module assigned to the MASTER slot on the Custom Layer Setup page of the Layer Key Setup Screen.

⑫ SEND indicator

- This indicator will be unlit when the SENDS ON FADER key is off (Sends On Fader mode is off).
- When the SENDS ON FADER key is on (Sends On Fader mode is on), the MUTE, SOLO and SEL keys, the color bar and the MASTER fader in the top panel master section will control/display the SENDS ON FADER operation bus (MIX 1–22/FX 1–4) and the indicator will light.

⑬ Color bar (MASTER)

- When the SENDS ON FADER is off (Sends On Fader mode is off), this lights with this color set for the module assigned to the MASTER slot on the Custom Layer Setup page of the Layer Key Setup Screen (MAIN L/R by default). (See “Changing set module colors” on page 168.)
- When the SENDS ON FADER key is on (Sends On Fader mode is on), this lights with the color set for the selected bus master module. (See “Changing set module colors” on page 168.)

⑭ LAYER KEY 1–7 and indicators

- Press these keys to switch layers. The last pressed key will light, showing the current selection. Switching layers will change the states of module faders, MUTE/SOLO/SEL keys, channel screens, color bars and touchscreens to correspond to the current layer.
- The layer assignments of keys and their colors can be set freely by opening Menu Screen > Front Panel Setup menu > Layer/Master Fader Setup. (See “Layer Key SETUP page” on page 55.)

NOTE

The Layer Key SETUP screen for the selected LAYER key can be opened by pressing that key while pressing the MENU key. (See “Layer Key SETUP page” on page 55 and “13 – List of shortcut operations” on page 244.)

⑮ MASTER fader

- When the SENDS ON FADER key is off (Sends On Fader mode is off), this adjusts the fader level of the module assigned to the MASTER slot on the Custom Layer Setup page of the Layer Key Setup Screen (MAIN L/R by default).
- When the SENDS ON FADER key is on (Sends On Fader mode is on), this adjusts the fader level of the selected bus master module.

⑯ FIX LAYER key and indicator

- While pressing this key, press a SEL key for a block to fix the corresponding block of 8 channels to the current layer. This key and the LAYER KEY that corresponds to the fixed layer will blink. “FIXED LAYER” will be shown on a white band at the top of the corresponding channel screen.
- While pressing this key, press a SEL key for a block with a fixed layer to cancel fixing the corresponding block of 8 channels to a layer. This key and the LAYER KEY that corresponds to the layer that is no longer fixed will stop blinking. “FIXED LAYER” will stop being shown at the top of the corresponding channel screen.
- Either the left or right block of 8 channels can be fixed at a time.

⑰ USB port (5V --- 0.5A)

This is a USB Type-C port. (This supports USB 2.0.)

- Connect a USB keyboard here, and use it to enter names, for example. By default, the unit is set to use a Japanese keyboard. Since English and Japanese keyboards use different layouts, change the setting on the PREFERENCES screen if using an English keyboard. (See “PREFERENCES screen” on page 36.)
- Load a USB flash drive to play files on it, as well as to load data into and back up data from this unit.
- Mice and other pointing devices are not supported.

⑱ SD card slot

SD cards can be inserted into this slot. (See “Connecting and disconnecting SD cards and USB flash drives” on page 33.)

Load an SD card to play files on it and record to it, as well as to load data into and back up data from this unit.

2 – Names and Functions of Parts

25 MONITOR OUT volume

Use this to adjust the output level of the MAIN OUTPUT L/R jacks.

26 TALKBACK volume

Use this to adjust the TALKBACK input level.

27 TALKBACK key and indicator

- This key turns talkback on and off. Press this key briefly to switch it on/off. Press this key continuously to turn the function on only while being pressed.
- The MONITOR SETUP screen TALKBACK/OSCILLATOR page, which is where various talkback settings can be made, can be opened by pressing this key while pressing the MENU key. (See “Making talkback and built-in oscillator settings” on page 62 and “13 – List of shortcut operations” on page 244.)

28 SENDS ON FADER key and indicator

This turns the Sends On Fader mode on/off.

- When the SENDS ON FADER key is on (Sends On Fader mode is on), this key lights and the unit operates as follows.
 - The SENDS ON FADER screen opens on the rightmost touchscreen. (See “SENDS ON FADER function” on page 152.)
 - This changes the Channel Screens to Sends On Fader mode display.
 - The channel faders move to the SEND level positions of the selected buses.
 - The MASTER fader moves to the FADER level position of the selected bus.
- Press this key when the SENDS ON FADER screen is shown to end Sends On Fader mode. This will close the SENDS ON FADER screen and return the channel faders, MASTER fader and channel screens to their normal display states. (See “SENDS ON FADER function” on page 152.)

29 USER KEY 1–12 and indicators

- Users can assign functions and colors to these keys as they like. When functions that have different statuses are assigned to these keys, they will light, blink and become unlit accordingly. (See “USER DEFINED CONTROLS screen” on page 44.)
- Press one of these keys while pressing the MENU key to open the screen that corresponds to its assigned function. (See “13 – List of shortcut operations” on page 244.)

Front panel

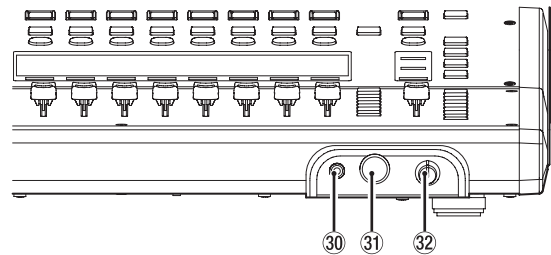

30 Headphone jack (stereo mini)

Use this 3.5mm (1/8") stereo mini jack to connect stereo headphones.

31 Headphone jack (stereo phone)

Use this 6.3mm (1/4") stereo phone jack to connect stereo headphones.

32 Headphone volume

Use this to adjust the headphone output level.

⚠ CAUTION

Before connecting headphones, minimize the volume with the headphone knob. Failure to do so might cause sudden loud noises, which could harm your hearing or result in other trouble.

2 – Names and Functions of Parts

Rear panel

Sonicview 16

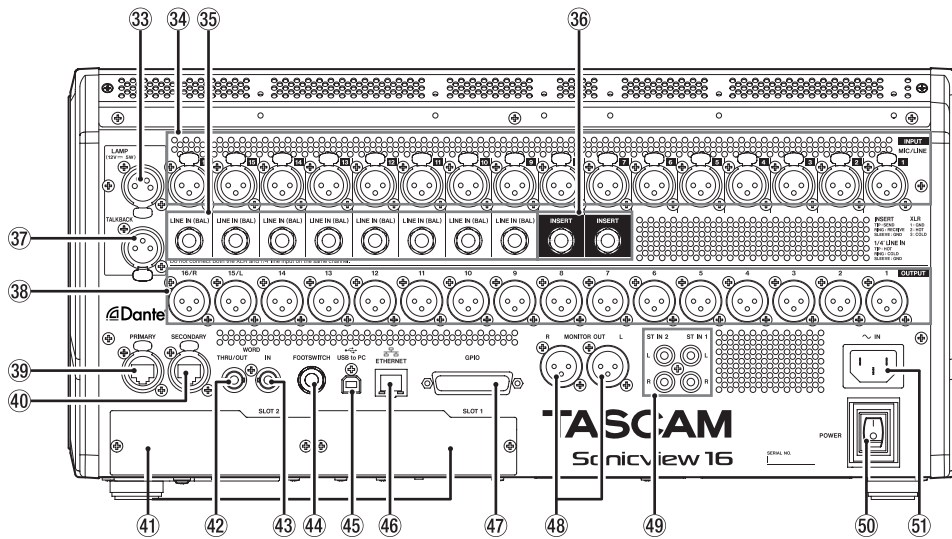

Sonicview 24

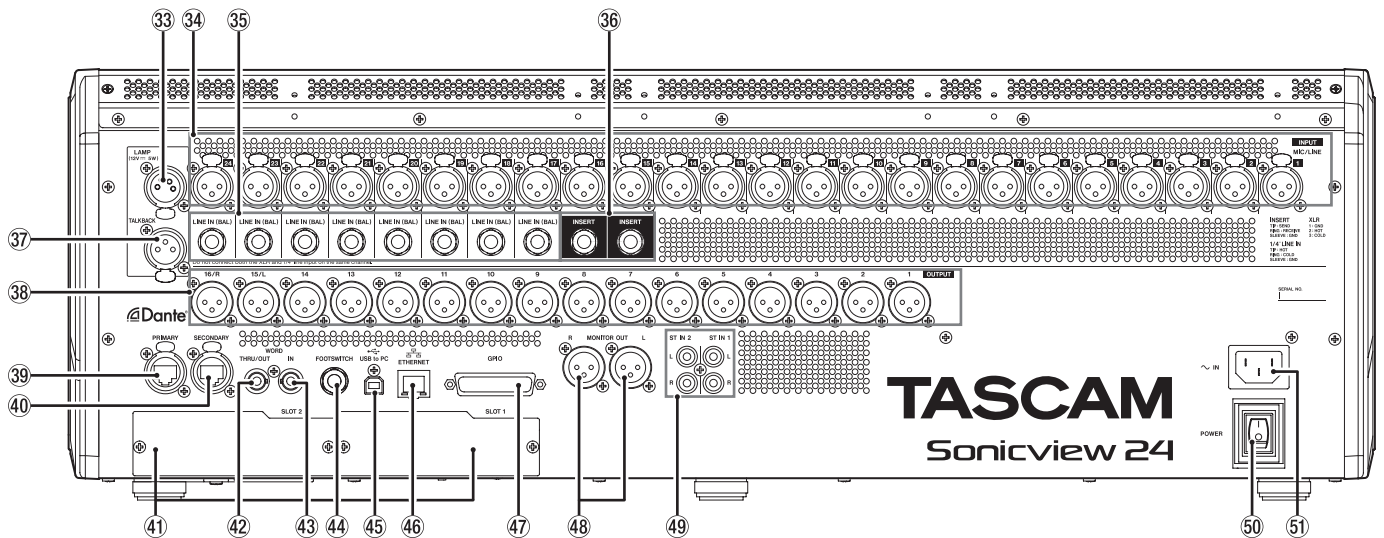

③③ LAMP jack

Use this to connect a gooseneck lamp to the illuminate the top of the unit.

Lamps with 4-pin XLR connectors can be used.

Adjust the lamp brightness on the PREFERENCES Screen. (See "PREFERENCES screen" on page 36.)

- XLR 4-pin female (pin 4: +12V, pin 3: GND)

③④ MIC/LINE input jacks

These are balanced XLR jacks for mic/line input.

- XLR (1: GND, 2: HOT, 3: COLD)

③⑤ LINE IN (BAL) jacks (TRS phone)

These are 6.3mm (1/4") TRS phone jacks for line input.

- TRS (Tip: HOT, Ring: COLD, Sleeve: GND)

NOTE

- This unit has some channels with two types of input jacks (XLR and TRS). Do not input signals through both the XLR and TRS jacks of the same channel at the same time. If signals are input at the same time, they will not be input properly.
- Only MIC/LINE input jacks (③④) provide phantom power.

2 – Names and Functions of Parts

③⑥ INSERT jacks (TRS phone)

Use these 6.3mm (1/4") TRS phone jacks to connect external devices (including effects).

- TRS (Tip: SEND, Ring: RETURN, Sleeve: GND)

③⑦ TALKBACK input jack

- Connect a talkback mic here.
- Use the TALKBACK volume knob (②⑥) to adjust the talkback input level, and use the TALKBACK key (②⑦) to turn it on/off.
- Make talkback settings on the MONITOR SETUP screen TALKBACK/OSCILLATOR page. (See "Making talkback and built-in oscillator settings" on page 62.)

③⑧ Analog output jacks

These analog outputs are XLR jacks.

- XLR (1: GND, 2: HOT, 3: COLD)

③⑨ Dante PRIMARY connector

This is the main etherCON Cat5e-compatible Dante transmission connector.

Use this to connect to a Dante network all the time.

Make settings for the built-in Dante module on the Dante SETUP Screen. (See "Dante SETUP screen" on page 63.)

④⑩ Dante SECONDARY connector

This is the secondary etherCON Cat5e-compatible Dante transmission connector. The use changes depending on the mode.

When in redundant mode, this connects to the secondary Dante network.

When in switched (daisy-chain) mode, use this to connect another Dante device in the chain.

Make settings for the built-in Dante module on the Dante SETUP Screen. (See "Dante SETUP screen" on page 63.)

④① Expansion card slots (SLOT 1/SLOT 2)

These slots can be used to install expansion cards (sold separately).

Make SLOT settings on the SLOT SETUP Screen. (See "SLOT SETUP screen" on page 92.)

④② WORD THRU/OUT connector

This BNC connector is for word clock output.

Use it for thru and normal output of word clock signals.

Switch word thru/output on the SYNC CLOCK Screen. (See "SYNC CLOCK screen" on page 34.)

④③ WORD IN connector

This BNC connector is for word clock input.

Use it for word clock signal input.

Connect a word clock signal to this connector when synchronizing the word clock of this unit and other equipment.

④④ FOOTSWITCH jack

This 6.3mm (1/4") TS phone jack is for connecting a footswitch.

Set functions assigned to the footswitch on the USER DEFINED CONTROL Screen Foot Switch page. (See "Foot Switch page" on page 53.)

- TS (Tip: HOT, Sleeve: GND)

④⑤ USB to PC port

This is a USB Type-B port.

Use a USB cable (Type-A to Type-B) to connect the unit to a computer.

ATTENTION

The unit should be connected directly to the computer, not through a USB hub. Moreover, proper transmission with a computer could fail if the cable is too long.

④⑥ ETHERNET port

This is an Ethernet port.

Use this to connect to a network, primarily for the purpose of remote control of this unit using the dedicated TASCAM Sonicview Control application.

Make network settings on the Network Setup Screen. (See "Network Setup screen" on page 95.)

For details about the TASCAM Sonicview Control application, see its manual. You can download the application manual from the TEAC Global Site (<https://teac-global.com/>).

④⑦ GPIO connector

This is a 25-pin D-sub Parallel control input/output connector.

It can send and receive control commands with 8 inputs and 8 outputs. See "GPIO connector overview" on page 15 for details about pin assignments.

Set functions assigned to the GPIO input connector on the USER DEFINED CONTROL Screen GPIO-IN page. (See "GPIO-IN page" on page 53.)

Set functions assigned to the GPIO output connector on the USER DEFINED CONTROL Screen GPIO-OUT page. (See "GPIO-OUT page" on page 54.)

2 – Names and Functions of Parts

48 MONITOR OUT L/R jacks

These analog outputs are XLR jacks.

Make monitor output settings on the MONITOR SETUP screen MONITOR/SOLO page. (See “Making monitor output and solo function settings” on page 59.)

- XLR (1: GND, 2: HOT, 3: COLD)

49 ST IN 1/ST IN 2 jacks

These RCA pin jacks are analog line outputs.

Use RCA cables to connect CD players and similar devices to these jacks.

50 POWER switch

This turns the power on/off.

⚠ CAUTION

Before turning the power on or off, minimize the volumes of connected equipment. Failure to do so might cause sudden loud noises, which could harm your hearing or result in other trouble.

NOTE

- Do not interrupt the power when the unit is operating (including recording, playing back, or writing data to an SD card or USB flash drive). Doing so could cause proper recording to fail and recorded data to be lost.
- We recommend executing the Save Current Settings command on the Menu Screen before turning the unit off. (See “Saving the current settings” on page 97.)

51 AC IN connector

Plug the included power cord in here.

GPIO connector overview

The GPIO connector on the back of the unit is a parallel control connector that allows this unit to control and be controlled by other devices.

GPIO connector function settings can be changed on the USER DEFINED CONTROLS Screen GPIO-IN and GPIO-OUT pages. (See “USER DEFINED CONTROLS screen” on page 44.)

The pin assignments are as follows.

| Pin No. | Function | IN/OUT |
|---------|------------|--------|
| 1 | GND | - |
| 2 | GPIO IN 2 | IN |
| 3 | GPIO IN 4 | IN |
| 4 | GPIO IN 6 | IN |
| 5 | GPIO IN 8 | IN |
| 6 | NC | - |
| 7 | NC | - |
| 8 | NC | - |
| 9 | GPIO OUT 2 | OUT |
| 10 | GPIO OUT 4 | OUT |
| 11 | GPIO OUT 6 | OUT |
| 12 | GPIO OUT 8 | OUT |
| 13 | NC | - |
| 14 | GPIO IN 1 | IN |
| 15 | GPIO IN 3 | IN |
| 16 | GPIO IN 5 | IN |
| 17 | GPIO IN 7 | IN |
| 18 | NC | - |
| 19 | NC | - |
| 20 | GND | - |
| 21 | GPIO OUT 1 | OUT |
| 22 | GPIO OUT 3 | OUT |
| 23 | GPIO OUT 5 | OUT |
| 24 | GPIO OUT 7 | OUT |
| 25 | +5V | - |

IN: For command input

- Internal circuit with +5V pull-up
- Operates with low signal input of 50 msec or longer

OUT: For command and tally output

- Internal circuit is open collector (10Ω output impedance)
- 20V dielectric strength, 35mA maximum current

+5V: 50mA maximum supplied current

2 – Names and Functions of Parts

Basic unit operations

Touchscreen operations

Tap/swipe items on the touchscreens to operate them.

Special touchscreen operations

| | |
|------------------------|--|
| Touch continuously | Touch the +48V button continuously to turn phantom power (+48V) on and off. |
| Tap/touch continuously | Tapping the DIM button on the MONITOR/SOLO page of the MONITOR SETUP screen, or tapping the TALKBACK button on the TALKBACK/OSCILLATOR page will turn that function on/off. Touching it continuously will turn it on temporarily until released. |

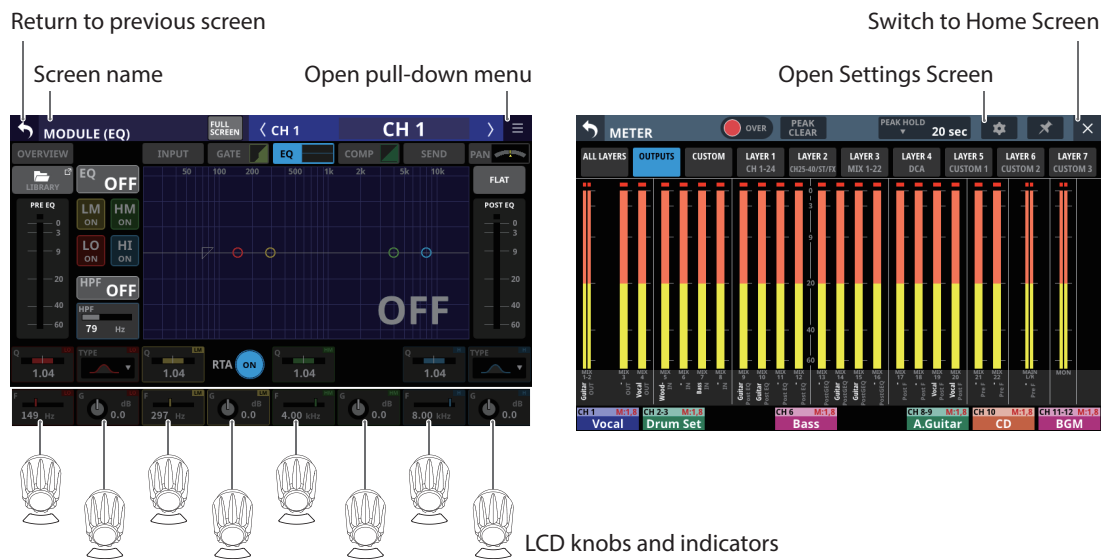

LCD knob operations

The LCD knobs can be used to control the parameters shown and selected above them on the touchscreen. When LCD knobs can be used, the corresponding indicators light.

| LCD knob | Explanation |
|-----------------------|---|
| Turn without pressing | This allows precise adjustment of one step per click. |
| Turn while pressing | This allows quick parameter adjustment from one extreme to the other. |

Top panel key operations

Press keys on the top panel to use them.

The following keys have special operation procedures.

| Key | Use |
|---------------------|--|
| TALKBACK key | Press this key briefly to turn talkback on/off. Press this key continuously to turn the function on only while being pressed. |
| HOME key + MENU key | Press and hold the HOME and MENU keys together for 5 seconds to open the LOCK SETUP Screen. |

NOTE

The parameters of this unit have unified image colors, making identification of parameter types easy by color.

- GAIN/Level: Red
- GATE: Yellow-green
- EQ: Blue
- COMP: Green
- FX: Yellow-green
- AUX mode bus: Orange
- GROUP mode bus: Purple
- PAN: Yellow
- FADER: Light blue

2 – Names and Functions of Parts

Home Screen

This unit has multiple Home Screens for its layers. The names of modules assigned to layers, various parameters, meters and other items are shown in lists.

Press LAYER KEY 1–7 to change what is shown on the Home Screen.

NOTE

When the Menu Screen or a settings screen is open, press the HOME key to return to the Home Screen.

CH 1–40 Module Home Screen



CH 1–40 Module Home Screen

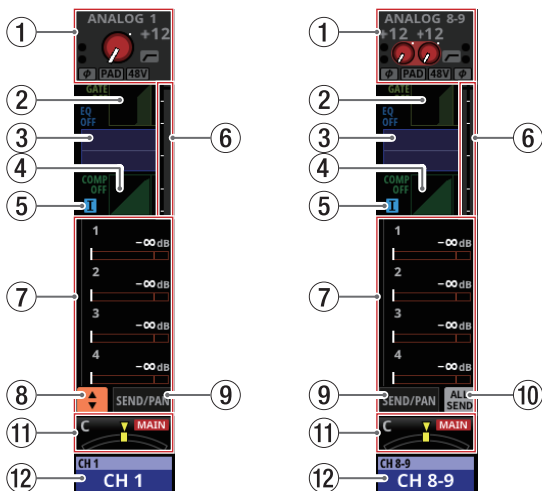

CH 1–40 Module Home Screen details

① INPUT area

- This shows the input settings of the selected input source. (A stereo module is shown on the right.)

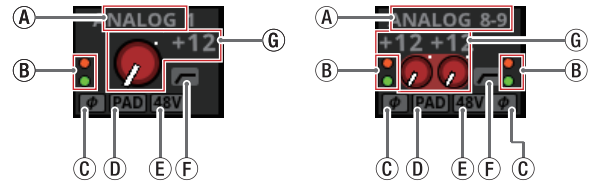

Input area display when the input source is “ANALOG” or “SB-16D connected by built-in Dante”

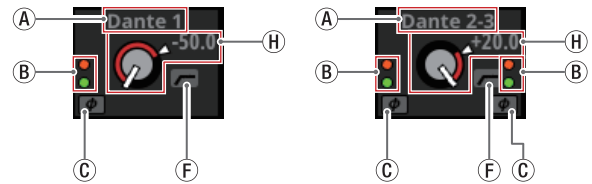

Input area display when the input source is not “ANALOG” or “SB-16D connected by built-in Dante”

- This shows the input source name.

- If a Dante port that has a mounted SB-16D assigned is selected, “SB#[ID] [port number]” will be shown.



If it is a virtually-mounted SB-16D,  will appear to the bottom left of the port name.



- If the module is stereo and input sources that are not left-right adjacent are selected, input source names will appear split left and right and abbreviated as follows.



| Input source name | Input source name abbreviation |
|-------------------|--------------------------------|
| ANALOG | AN |
| Dante | DA |
| SLOT 1 | S1 |
| USB | US |
| ST IN 1 | ST1 |
| PLAYER | PL |

2 – Names and Functions of Parts

- When a module is stereo, if a Dante port that has a mounted SB-16D assigned is selected, “# [ID] [port number]” will be shown.



If it is a virtually-mounted SB-16D, the # background will be yellow.

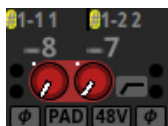

- Ⓑ These indicators appear to light as shown below depending on the input level. When a module is stereo, two sets of module indicators will be shown separately left and right.

Red: -3 dBFS, Green: -40 dBFS

- Ⓒ This shows the input signal phase setting status. When a module is stereo, two module phase settings will be shown separately left and right.

| | |
|--|----------|
| | Normal |
| | Reversed |

- Ⓓ This shows the -20dB pad setting status when the input source of the selected module is “ANALOG” or “SB-16D connected by built-in Dante”. When on, the icon will appear highlighted.
If the input sources for both the left and right channels of a stereo module are “ANALOG” or “SB-16D connected by built-in Dante”, this shows the left channel setting.
- Ⓔ This shows the phantom power (+48V) setting status when the input source of the selected module is “ANALOG” or “SB-16D connected by built-in Dante”. When on, the icon will appear highlighted.
If the input sources for both the left and right channels of a stereo module are “ANALOG” or “SB-16D connected by built-in Dante”, this shows the left channel setting.
- Ⓕ This shows the HPF setting status. When on, the icon will appear highlighted.
- Ⓖ When the input source of the selected module is “ANALOG” or “SB-16D connected by built-in Dante”, this will show an analog gain knob and the input level of the unit or SB-16D MIC/LINE input jacks. When a module is stereo, two knobs and input level values will be shown for the module.
A black knob that cannot be operated will be shown if the input source is an SB-16D for which control privileges are not held.



- Ⓗ A D.TRIM knob and the digital trim value will be shown when the input source of the selected module is not “ANALOG” or “SB-16D connected by built-in Dante”.

- Tap this area to show the selection frame. When the selection frame is shown, corresponding LCD knobs can be used to adjust the parameters shown.
- When the selection frame is shown, tap this area to open the MODULE (INPUT) Screen for the selected module. (See “MODULE (INPUT) Screen” on page 128.)

② GATE/EXPANDER/DE-ESSER area

- This shows the response graphs and gain reduction meters of dynamics effects.
- Tap this area to open the MODULE (GATE/EXPANDER/DE-ESSER) Screen for the selected module. (See “MODULE (GATE/EXPANDER/DE-ESSER) screens” on page 136.)

③ HPF/EQ area

- This shows graphs of the HPF and EQ frequency responses.
- Tap this area to open the MODULE (EQ) Screen for the selected module. (See “MODULE (EQ) Screen” on page 138.)

④ COMP/DUCKER area

- This shows the response graphs and gain reduction meters of dynamics effects.
- Tap this area to open the MODULE (COMP/DUCKER) Screen for the selected module. (See “MODULE (COMP/DUCKER) Screen” on page 142.)

⑤ INSERT indicator

The indicator is shown when the INSERT button is on for the CH 1–40 module.

⑥ Level meter

This shows the level of the signal at the set metering point. (See “METERING POINT page” on page 40 and “MODULE (OVERVIEW) Screen” on page 116.)

NOTE

- If the selected module is stereo, a stereo level meter will be shown.
- Each level meter has an overload indicator at its top. They will appear to light red when the signal level reaches or exceeds -0.00026 dBFS (16-bit full-scale value).
- When a level overload occurs, the entire bar meter will light red.
- The area below -60 dBFS at the bottom of the level meters will light when above -70 dBFS.

2 – Names and Functions of Parts

⑦ SEND area

- This shows the states of SEND settings to MIX 1–22 and FX 1–4 buses 4 at a time.

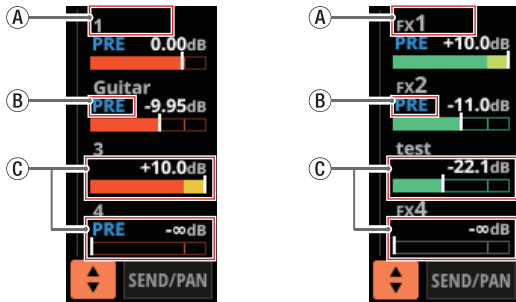

- Ⓐ This shows the user module name for the MIX 1–22 or FX RTN 1–4 module. If the name has not been defined, the module name will be shown as “1” or “FX 1”, for example.
- Ⓑ This shows the PRE/POST setting used for MIX 1–22 and FX 1–4 buses.

| | |
|--------------|-------------|
| No indicator | Set to POST |
| PRE | Set to PRE |

- Ⓒ These show the assignment state and send level to MIX 1–22 and FX 1–4 buses in AUX mode.

| | |
|--------------|-----------------|
| MIX 1–22 bus | Shown in orange |
| FX 1–4 bus | Shown in green |

This will be gray when not assigned.

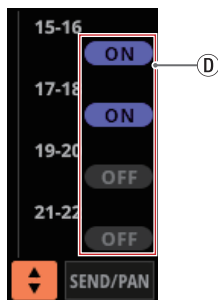

- Ⓓ Purple rounded buttons are shown when GROUP mode MIX 1–22 buses are ON. These appear but cannot be turned on/off on the Home Screen.



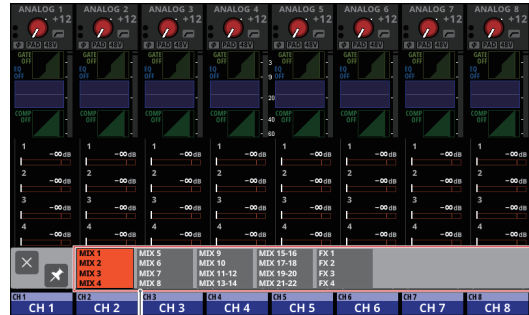

- Tap a SEND level to show the selection frame. When the selection frame is shown, corresponding LCD knobs can be used to adjust the SEND level shown.
- Tap the SEND level while pressing the HOME key to set the SEND level for that bus to 0 dB. (See “13 – List of shortcut operations” on page 244.)

⑧ button

Tap this button to show the selection window for the bus shown in the SEND area.



bus selection button

- Tap a bus selection button to open the selected bus group in the SEND area.
- Tap the  button at the top left of the selection window to close it.
- When the  button is off () , tapping the bus selection button will automatically close this window.
- When the  button is on () , tapping a bus selection button will not close this window.

⑨ SEND/PAN button

Tap this button to open the MODULE (SEND/PAN) Screen. (See “MODULE (SEND/PAN) Screen” on page 144.)

2 – Names and Functions of Parts

10 ALL SEND button

Tap this button to change the SEND area display to ALL SEND bus display.

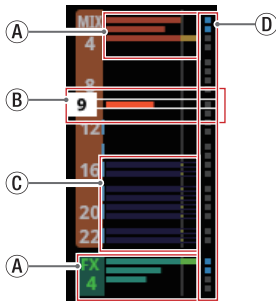
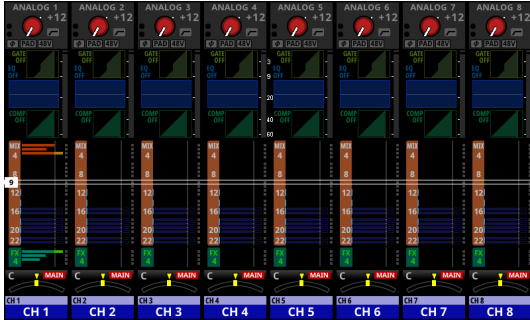

A These show the assignment state and send level to MIX 1–22 and FX 1–4 buses in AUX mode.

| | |
|--------------|-----------------|
| MIX 1–22 bus | Shown in orange |
| FX 1–4 bus | Shown in green |

This will be gray when not assigned.

B When the selection frame is shown, corresponding LCD knobs can be used to adjust the SEND levels shown.

The selection frame can also be swiped up and down to select MIX 1–22 and FX 1–4 buses.

C These show the assignment state and send level to MIX 1–22 buses in GROUP mode. These appear but cannot be adjusted.

| | |
|-----|------------------------|
| OFF | Shown in dark purple |
| ON | Shown in bright purple |

D These appear light blue when the PRE/POST setting used for MIX 1–22 and FX 1–4 buses is “PRE”.

- Tap the ALL SEND bus area to switch to showing 4 buses in the tapped area.

11 PAN area

- This shows the pan/balance setting of the signals sent to the MAIN L/R bus as well as the MAIN L/R bus assignment status.
- Tap this area to show the selection frame. When the selection frame is shown, corresponding LCD knobs can be used to adjust the pan/balance of the sent signals.
- Tap this area while pressing the HOME key to set the tapped pan/balance setting to center (C). (See “13 – List of shortcut operations” on page 244.)
- When the selection frame is shown, tap this area to open the MODULE (SEND/ PAN) Screen. (See “MODULE (SEND/ PAN) Screen” on page 144.)

12 NAME area

- The module name is shown at the top left.
- At the top right, the Mute Group assignment status is shown in the top line and the DCA assignment status is shown in the bottom line. Red numbers show the assigned Mute Group numbers. Yellow numbers show the assigned DCA numbers.



See “Mute Group Assign page” on page 164 and “MODULE (OVERVIEW) Screen” on page 116 for changing Mute Group assignments.

See “DCA Assign page” on page 163 and “MODULE (OVERVIEW) Screen” on page 116 for changing DCA assignments.

- The bottom line shows the user module name (name set by user). If the name has not been defined, the module name will be shown as “CH 1”, for example. See “Setting and editing user module names” on page 167 for details about setting user module names.
- The NAME area background color is the color set for the assigned module. See “Changing set module colors” on page 168 to change set module colors.
- Tap this area to open the MODULE (OVERVIEW) Screen. (See “MODULE (OVERVIEW) Screen” on page 116.)

2 – Names and Functions of Parts

ST IN 1–2/FX RTN 1–4 Module Home Screen



ST IN 1–2/FX RTN 1–4 Module Home Screen

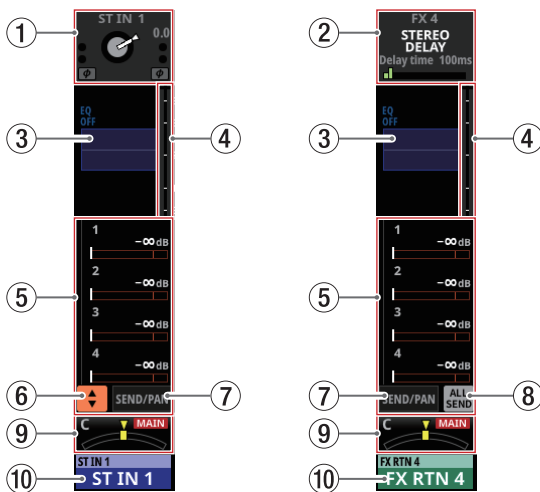

ST IN 1–2/FX RTN 1–4 Module Home Screen details

① INPUT area

- This shows the input settings of the selected input source.

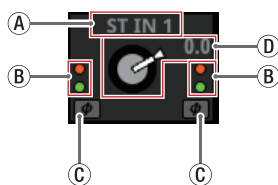

Input area display when the input source is not “ANALOG” or “SB-16D connected by built-in Dante”

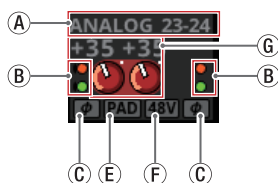

Input area display when the input source is “ANALOG” or “SB-16D connected by built-in Dante”

- Ⓐ This shows the input source name.

- If a Dante port that has a mounted SB-16D assigned is selected, “SB#[ID] [port number]” will be shown.



If it is a virtually-mounted SB-16D, Ⓜ will appear to the bottom left of the port name.



- If the module is stereo and input sources that are not left-right adjacent are selected, input source names will appear split left and right and abbreviated as follows.



| Input source name | Input source name abbreviation |
|-------------------|--------------------------------|
| ANALOG | AN |
| Dante | DA |
| SLOT 1 | S1 |
| USB | US |
| ST IN 1 | ST1 |
| PLAYER | PL |

- When a module is stereo, if a Dante port that has a mounted SB-16D assigned is selected, “#[ID] [port number]” will be shown.



If it is a virtually-mounted SB-16D, the # background will be yellow.



- Ⓑ These indicators appear to light as shown below depending on the input level.

Red: -3 dBFS, Green: -40 dBFS

- Ⓒ This shows the input signal phase setting status.

| | |
|--|----------|
| | Normal |
| | Reversed |

2 – Names and Functions of Parts

① A D.TRIM knob and the digital trim value will be shown when the input source of the selected module is not “ANALOG” or “SB-16D connected by built-in Dante”.

② This shows the -20dB pad setting status when the input source of the selected module is “ANALOG” or “SB-16D connected by built-in Dante”. When on, the icon will appear highlighted.

If the input sources for both the left and right channels of a stereo module are “ANALOG” or “SB-16D connected by built-in Dante”, this shows the left channel setting.

③ This shows the phantom power (+48V) setting status when the input source of the selected module is “ANALOG” or “SB-16D connected by built-in Dante”. When on, the icon will appear highlighted.

If the input sources for both the left and right channels of a stereo module are “ANALOG” or “SB-16D connected by built-in Dante”, this shows the left channel setting.

④ When the input source of the selected module is “ANALOG” or “SB-16D connected by built-in Dante”, this will show 2 analog gain knobs and the input level values of the unit or SB-16D MIC/LINE input jacks.

A black knob that cannot be operated will be shown if the input source is an SB-16D for which control privileges are not held.



- Tap this area to show the selection frame. When the selection frame is shown, corresponding LCD knobs can be used to adjust the parameters shown.
- When the selection frame is shown, tap this area to open the MODULE (INPUT) Screen for the selected module. (See “MODULE (INPUT) Screen” on page 128.)

② FX area

- This shows effects names and main effect parameters.
- Tap this area to show the selection frame. When the selection frame is shown, corresponding LCD knobs can be used to adjust effect parameters shown.
- When the selection frame is shown, tap this area to open the MODULE (FX) Screen for the selected module. (See “MODULE (FX) Screen” on page 132.)

③ EQ area

- This shows a graph of the EQ frequency response.
- Tap this area to open the MODULE (EQ) Screen for the selected module. (See “MODULE (EQ) Screen” on page 138.)

④ Level meters

This shows the level of the signal at the set metering point. (See “METERING POINT page” on page 40, “ST IN 1–2 MODULE (OVERVIEW) Screens” on page 121 and “FX RTN 1–4 MODULE (OVERVIEW) Screens” on page 124.)

NOTE

- The ST IN 1–2/FX RTN 1–4 modules are stereo, so stereo level meters are shown.
- Each level meter has an overload indicator at its top. They will appear to light red when the signal level reaches or exceeds -0.00026 dBFS (16-bit full-scale value).
- When a level overload occurs, the entire bar meter will light red.
- The area below -60 dBFS at the bottom of the level meters will light when above -70 dBFS.

⑤ SEND area

- This shows the states of SEND settings to MIX 1–22 and FX 1–4 buses 4 at a time.

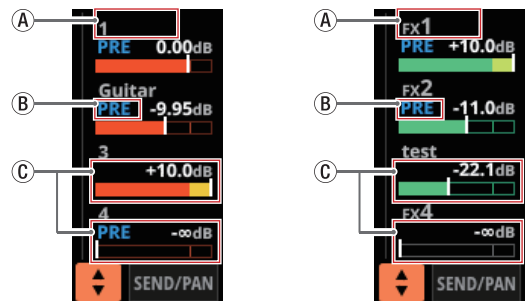

- ① This shows the user module name for the MIX 1–22 or FX RTN 1–4 module. If the name has not been defined, the module name will be shown as “1” or “FX 1”, for example.
- ② This shows the PRE/POST setting used for MIX 1–22 and FX 1–4 buses.

| | |
|--------------|-------------|
| No indicator | Set to POST |
| PRE | Set to PRE |

- ③ These show the assignment state and send level to MIX 1–22 and FX 1–4 buses in AUX mode.

| | |
|--------------|-----------------|
| MIX 1–22 bus | Shown in orange |
| FX 1–4 bus | Shown in green |

This will be gray when not assigned.

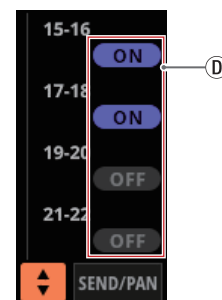

- ④ Purple rounded buttons are shown when GROUP mode MIX 1–22 buses are ON. These appear but cannot be turned on/off on the Home Screen.

2 – Names and Functions of Parts

⊛ ②, ③ and ④ are not shown in the FX 1–4 area of the FX RTN module.



- Tap a SEND level to show the selection frame. When the selection frame is shown, corresponding LCD knobs can be used to adjust the SEND level shown.
- Tap the SEND level while pressing the HOME key to set the SEND level for that bus to 0 dB. (See “13 – List of shortcut operations” on page 244.)

⑥ button

Tap this button to show the selection window for the bus shown in the SEND area.

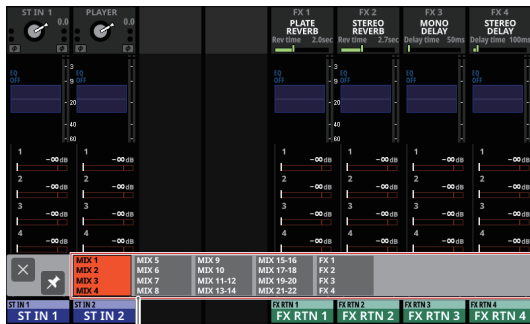

bus selection button

- Tap a bus selection button to open the selected bus group in the SEND area.
- Tap the button at the top left of the selection window to close it.
- When the button is off (), tapping the bus selection button will automatically close this window.
- When the button is on (), tapping a bus selection button will not close this window.

⑦ SEND/PAN button

Tap this button to open the MODULE (SEND/PAN) Screen. (See “MODULE (SEND/PAN) Screen” on page 144.)

⑧ ALL SEND button

Tap this button to change to the ALL SEND bus display.

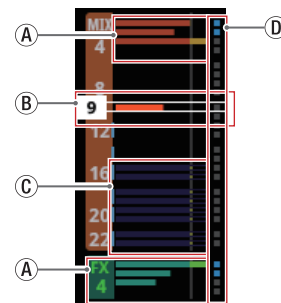
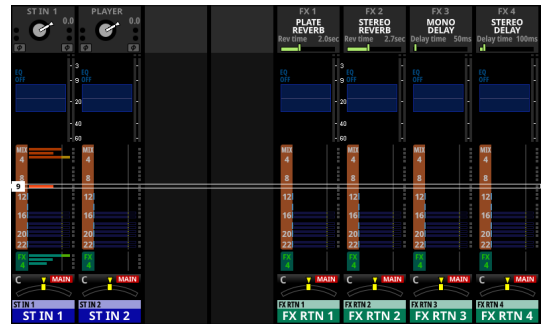

- ① These show the assignment state and send level to MIX 1–22 and FX 1–4 buses in AUX mode.

| | |
|--------------|-----------------|
| MIX 1–22 bus | Shown in orange |
| FX 1–4 bus | Shown in green |

This will be gray when not assigned.

- ② When the selection frame is shown, corresponding LCD knobs can be used to adjust the SEND levels shown.

The selection frame can also be swiped up and down to select MIX 1–22 and FX 1–4 buses.

- ③ These show the assignment state and send level to MIX 1–22 buses in GROUP mode. These appear but cannot be adjusted.

| | |
|-----|------------------------|
| OFF | Shown in dark purple |
| ON | Shown in bright purple |

- ④ These appear light blue when the PRE/POST setting used for MIX 1–22 and FX 1–4 buses is “PRE”.

- Tap the ALL SEND bus area to switch to showing 4 buses in the tapped area.

2 – Names and Functions of Parts

⑨ PAN area

- This shows the pan/balance setting of the signals sent to the MAIN L/R bus as well as the MAIN L/R bus assignment status.
- Tap this area to show the selection frame. When the selection frame is shown, corresponding LCD knobs can be used to adjust the pan/balance of the sent signals.
- Tap this area while pressing the HOME key to set the tapped pan/balance setting to center (C). (See “13 – List of shortcut operations” on page 244.)
- When the selection frame is shown, tap this area to open the MODULE (SEND/ PAN) Screen. (See “MODULE (SEND/ PAN) Screen” on page 144.)

⑩ NAME area

- The module name is shown at the top left.
- At the top right, the Mute Group assignment status is shown in the top line and the DCA assignment status is shown in the bottom line. Red numbers show the assigned Mute Group numbers. Yellow numbers show the assigned DCA numbers.



See “Mute Group Assign page” on page 164 and “MODULE (OVERVIEW) Screen” on page 116 for changing Mute Group assignments.

See “DCA Assign page” on page 163 and “MODULE (OVERVIEW) Screen” on page 116 for changing DCA assignments.

- The bottom line shows the user module name (name set by user). If the name has not been defined, the module name will be shown as “ST IN 1” or “FX RTN 1”, for example. See “Setting and editing user module names” on page 167 for details about setting user module names.
- The NAME area background color is the color set for the assigned module. See “Changing set module colors” on page 168 to change set module colors.
- Tap this area to open the MODULE (OVERVIEW) Screen. (See “ST IN 1–2 MODULE (OVERVIEW) Screens” on page 121.)

MIX 1–22 and MAIN L/R Master Module Home Screen

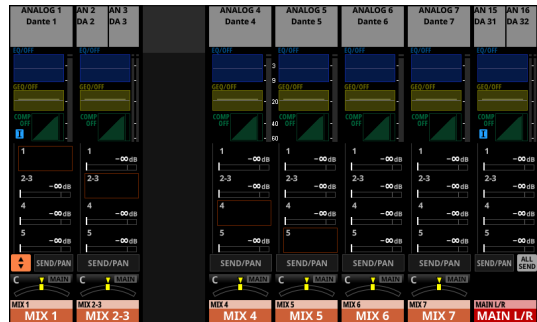

MIX 1–22 and MAIN L/R Master Module Home Screen

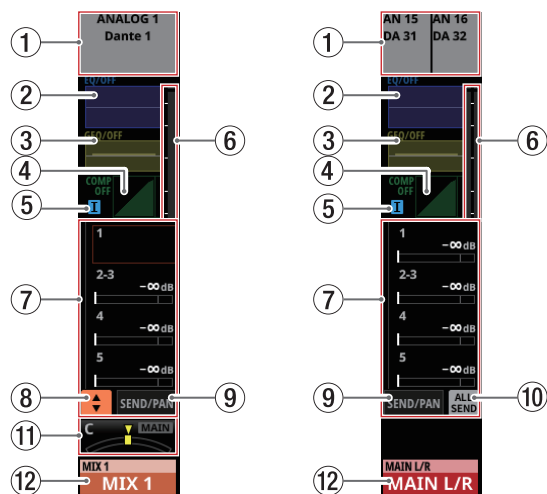

MIX 1–22 and MAIN L/R Master Module Home Screen details

① OUTPUT area

- This shows the output port assignment status.
 - If a Dante port that has a mounted SB-16D assigned is selected, “SB#[ID] [port number]” will be shown.

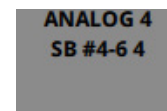

If it is a virtually-mounted SB-16D,  will appear to the left of the port name.

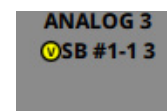

2 – Names and Functions of Parts

- If the module is stereo, output port names will appear split left and right and abbreviated as follows.

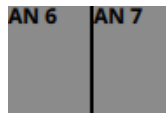

| Output port name | Output port name abbreviatio |
|------------------|------------------------------|
| ANALOG | AN |
| Dante | DA |
| SLOT 1 | S1 |
| USB | US |

- When a module is stereo, if a Dante port that has a mounted SB-16D assigned is selected, “[ID] [port number]” will be shown.

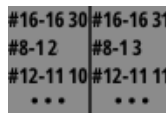

If it is a virtually-mounted SB-16D, the # background will be yellow.

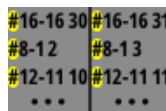

- Tap this area to open the MODULE (OUTPUT) Screen for the selected module. (See “MODULE (OUTPUT) Screen” on page 148.)

② EQ area

- This shows a graph of the EQ frequency response.
- Tap this area to open the MODULE (EQ) Screen for the selected module. (See “MODULE (EQ) Screen” on page 138.)

③ GEQ area

- This shows a graph of the GEQ frequency response.
- Tap this area to open the MODULE (GEQ) Screen for the selected module. (See “MODULE (GEQ) Screen” on page 140.)

④ COMP/DUCKER area

- This shows the response graphs and gain reduction meters of dynamics effects.
- Tap this area to open the MODULE (COMP/DUCKER) Screen for the selected module. (See “MODULE (COMP/DUCKER) Screen” on page 142.)

⑤ INSERT indicator

The  indicator is shown when the INSERT button is on for the MIX 1–22 module or MAIN L/R master module.

⑥ Level meters

This shows the level of the signal at the set metering point. (See “METERING POINT” page” on page 40 and “MIX 1–22 and MAIN L/R Master MODULE (OVERVIEW) Screens” on page 125.)

NOTE

- If the selected module is stereo, a stereo level meter will be shown.
- Each level meter has an overload indicator at its top. They will appear to light red when the signal level reaches or exceeds -0.00026 dBFS (16-bit full-scale value).
- When a level overload occurs, the entire bar meter will light red.
- The area below -60 dBFS at the bottom of the level meters will light when above -70 dBFS.

⑦ SEND area

- This shows the states of SEND settings to MIX 1–22 and FX 1–4 buses 4 at a time.

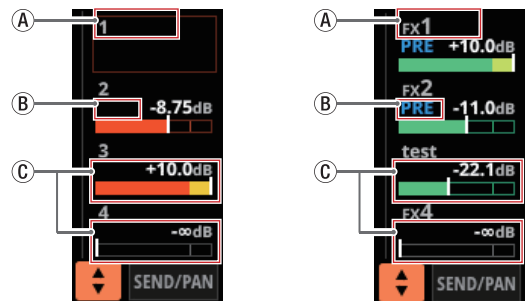

- ① This shows the user module name for the MIX 1–22 or FX RTN 1–4 module. If the name has not been defined, the module name will be shown as “1” or “FX 1”, for example.
- ② This shows the PRE/POST setting used for MIX 1–22 and FX 1–4 buses.

| | |
|--------------|-------------|
| No indicator | Set to POST |
| PRE | Set to PRE |

- ③ These show the assignment state and send level to MIX 1–22 and FX 1–4 buses in AUX mode.

| | |
|--------------|-----------------|
| MIX 1–22 bus | Shown in orange |
| FX 1–4 bus | Shown in green |

This will be gray when not assigned.

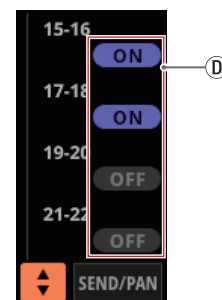

- ④ Purple rounded buttons are shown when GROUP mode MIX 1–22 buses are ON. These appear but cannot be turned on/off on the Home Screen.

2 – Names and Functions of Parts

※ ②, ③ and ④ are not shown in the bus areas of the corresponding modules themselves. ②, ③ and ④ are also not shown in the FX 1–4 area of the MAIN L/R Master module.

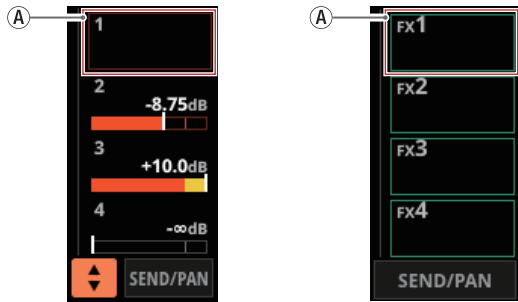



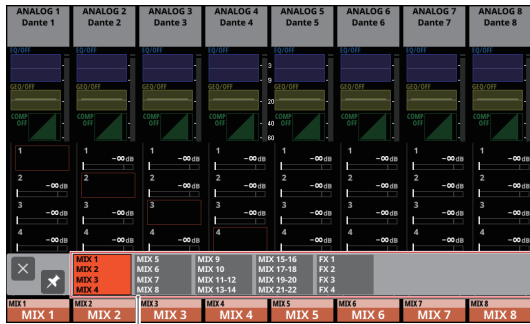

- Tap a SEND level to show the selection frame. When the selection frame is shown, corresponding LCD knobs can be used to adjust the SEND level shown.
- Tap the SEND level while pressing the HOME key to set the SEND level for that bus to 0 dB. (See “13 – List of shortcut operations” on page 244.)

⑧ button

Tap this button to show the selection window for the bus shown in the SEND area.



bus selection button

- Tap a bus selection button to open the selected bus group in the SEND area.
- Tap the  button at the top left of the selection window to close it.
- When the  button is off , tapping the bus selection button will automatically close this window.
- When the  button is on , tapping a bus selection button will not close this window.

⑨ SEND/PAN button

Tap this button to open the MODULE (SEND/PAN) Screen. (See “MODULE (SEND/PAN) Screen” on page 144.)

⑩ ALL SEND button

Tap this button to change to the ALL SEND bus display.

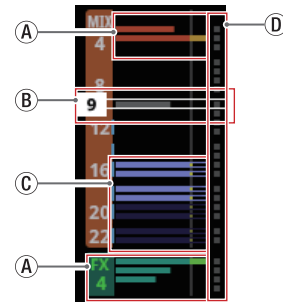
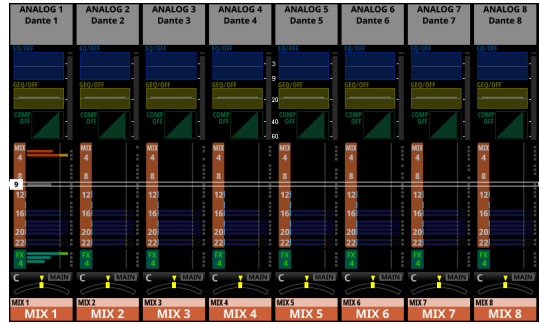

- ① These show the assignment state and send level to MIX 1–22 and FX 1–4 buses in AUX mode.

| | |
|--------------|-----------------|
| MIX 1–22 bus | Shown in orange |
| FX 1–4 bus | Shown in green |

This will be gray when not assigned.

- ② When the selection frame is shown, corresponding LCD knobs can be used to adjust the SEND levels shown.

The selection frame can also be swiped up and down to select MIX 1–22 and FX 1–4 buses.

- ③ These show the assignment state and send level to MIX 1–22 buses in GROUP mode. These appear but cannot be adjusted.

| | |
|-----|------------------------|
| OFF | Shown in dark purple |
| ON | Shown in bright purple |

- ④ These appear light blue when the PRE/POST setting used for MIX 1–22 and FX 1–4 buses is “PRE”.

- Tap the ALL SEND bus area to switch to showing 4 buses in the tapped area.

⑪ PAN area (MIX 1–22 modules only)

- This shows the pan/balance setting of the signals sent to the MAIN L/R bus as well as the MAIN L/R bus assignment status.
- Tap this area to show the selection frame. When the selection frame is shown, corresponding LCD knobs can be used to adjust the position/balance of the sent signals.
- Tap this area while pressing the HOME key to set the tapped pan/balance setting to center (C). (See “13 – List of shortcut operations” on page 244.)
- When the selection frame is shown, tap this area to open the MODULE (SEND/ PAN) Screen. (See “MODULE (SEND/ PAN) Screen” on page 144.)

⑫ NAME area

- The module name is shown at the top left.
- At the top right, the Mute Group assignment status is shown in the top line and the DCA assignment status is shown in the bottom line. Red numbers show the assigned Mute Group numbers. Yellow numbers show the assigned DCA numbers.



See “Mute Group Assign page” on page 164 and “MODULE (OVERVIEW) Screen” on page 116 for changing Mute Group assignments.

See “DCA Assign page” on page 163 and “MODULE (OVERVIEW) Screen” on page 116 for changing DCA assignments.

- The bottom line shows the user module name (name set by user). If the name has not been defined, the module name will be shown as “MIX 1”, for example. See “Setting and editing user module names” on page 167 for details about setting user module names.
- The NAME area background color is the color set for the assigned module. See “Changing set module colors” on page 168 to change set module colors.
- Tap this area to open the MODULE (OVERVIEW) Screen. (See “MIX 1–22 and MAIN L/R Master MODULE (OVERVIEW) Screens” on page 125.)

2 – Names and Functions of Parts

DCA Module Home Screen

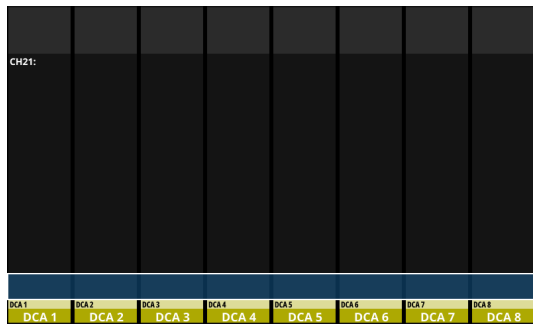

DCA Module Home Screen

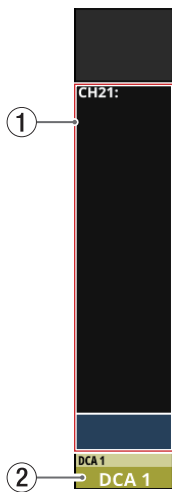

DCA Module Home Screen details

① DCA assignment display area

- This shows the names and user module names of modules that have been assigned to the corresponding DCAs.
- Tap this area to open the DCA/Mute Group SETUP Screen DCA Assign page. (See “DCA Assign page” on page 163.)

② NAME area

- The module name is shown at the top left.
- At the top right, the Mute Group assignment status is shown in the top line and the DCA assignment status is shown in the bottom line. Red numbers show the assigned Mute Group numbers. Yellow numbers show the assigned DCA numbers.



See “Mute Group Assign page” on page 164 for changing Mute Group assignments.

See “DCA Assign page” on page 163 for changing DCA assignments.

- The bottom line shows the user module name (name set by user). If the name has not been defined, the module name will be shown as “DCA 1”, for example. See “Setting and editing user module names” on page 167 for details about setting user module names.
- The NAME area background color is the color set for the assigned module. See “Changing set module colors” on page 168 to change set module colors.
- Tap this area to open the MODULE NAME Screen where the user module name and set module color can be changed. (See “MODULE NAME screen” on page 166.)

2 – Names and Functions of Parts

Menu Screen

Open various settings screens and use snapshot functions from this screen.

Press the MENU key to open this on the right touchscreen.

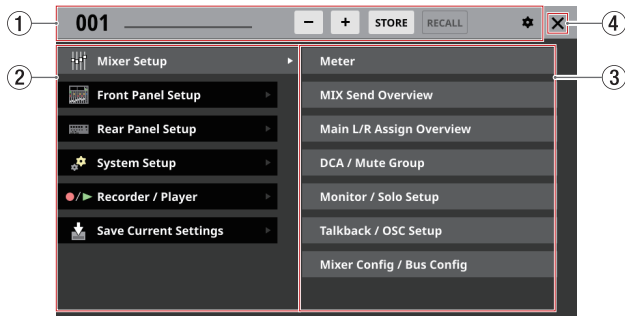

① Snapshot function area

This shows items related to the snapshot function. See “Snapshot functions” on page 170 for details about the snapshot function.

② Menu item area

This shows menu items. Tap a menu item to show its submenu items.

③ Submenu item area

This shows submenu items. If the submenu has 9 or more items, swipe the submenu area up and down to scroll it. Tap a submenu item to open a settings screen.

④ X button

Tap this button to close the Menu Screen.

Menu Screen operations

In this example, will open the TALKBACK Setup Screen.

1. Press the MENU button to switch to the Menu Screen.

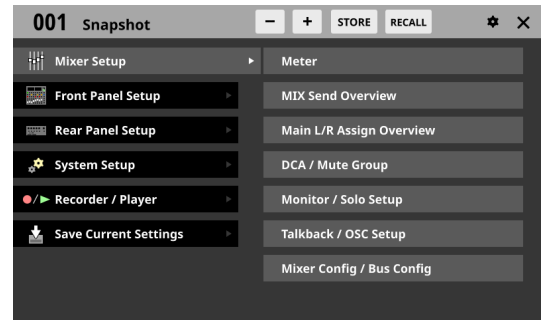

NOTE

When the Menu Screen is opened the first time after startup, submenu items will not be shown.

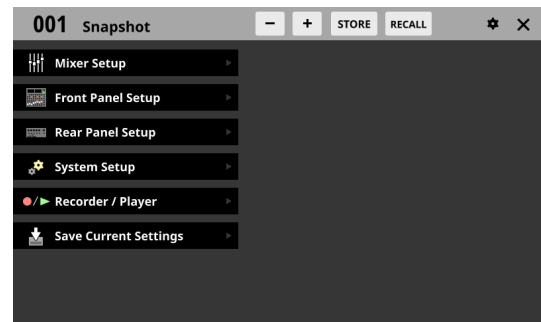

2. Tap “Front Panel Setup” in the menu item area to show its submenu items.

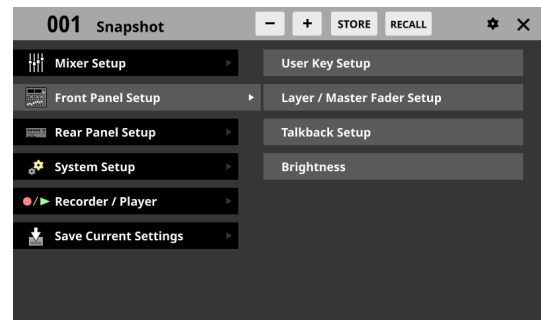

3. Tap “Talkback Setup” to open the MONITOR SETUP screen TALKBACK/OSCILLATOR page.

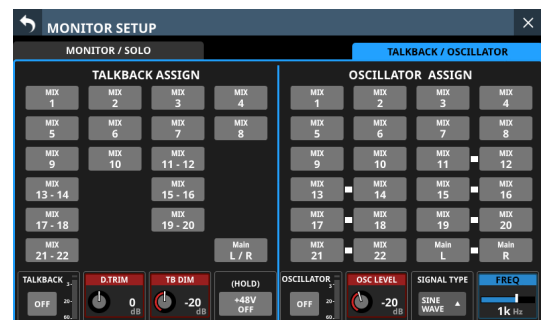

2 – Names and Functions of Parts

Menu structure

The following is an overview of the various menu items.

| Menu item | Sub menu item | Functions | Page |
|-------------------|---|---|----------|
| Mixer Setup | Meter | View various meters and set various meter display parameters | page 38 |
| | MIX Send Overview | View and use a list of MIX 1–22 / FX 1–4 / MAIN L/R bus send settings | page 153 |
| | Main L/R Assign Overview | View and use a list of MAIN L/R bus assignment states | page 158 |
| | DCA / Mute Group | Make the following settings <ul style="list-style-type: none"> • DCA assignments • Mute Group assignments • Turn Mute Group Master on/off | page 163 |
| | Monitor / Solo Setup | Make monitor output and solo function settings | page 59 |
| | Talkback / OSC Setup | Make talkback and built-in oscillator settings | page 62 |
| | Mixer Config / Bus Config | Make the following settings <ul style="list-style-type: none"> • CH 1–40 stereo link settings • DIRECT OUT POINT settings • DELAY POINT settings • INSERT POINT unified settings • BUS MODE settings • MIX 1–22 stereo link settings • Pan link settings | page 42 |
| Front Panel Setup | User Key Setup | Assign functions to the 18 USER KEYS | page 52 |
| | Layer / Master Fader Setup | Make the following settings <ul style="list-style-type: none"> • Assign channel sets and custom layers to the 7 LAYER KEYS • Assign module groups to custom layers • Assign modules to the MASTER fader | page 55 |
| | Talkback Setup | Make talkback settings | page 62 |
| | Brightness | Set the brightness of the various displays | page 36 |
| Rear Panel Setup | Dante Setup | Set and view the status of the built-in Dante module and an SB-16D connected via the built-in Dante module | page 63 |
| | Slot Setup | Set various functions of expansion cards loaded in SLOT 1 and SLOT 2 | page 92 |
| | WORD OUT Mode Setup | Make WORD OUT jack output mode settings | page 34 |
| | Network Setup | Make Network settings | page 95 |
| | FOOT SW Setup | Assign footswitch functions | page 53 |
| | GPIO Input Setup | Assign functions to the GPIO input connector | page 53 |
| | GPIO Output Setup | Assign functions to the GPIO output connector | page 54 |
| LAMP Dimmer Setup | Set the brightness of the lamp connected to the LAMP jack on the back of the unit | page 36 | |

2 – Names and Functions of Parts

| Menu item | Sub menu item | Functions | Page |
|-----------------------|----------------------|--|----------|
| System Setup | Info | View the state of the unit and error information | page 192 |
| | Sync Clock | Make the following settings <ul style="list-style-type: none"> • Sampling frequency • Master clock • Output mode of word clock output connector | page 34 |
| | Preferences | Make the following settings <ul style="list-style-type: none"> • USB Keyboard type setting • Confirmation when storing/recalling snapshots • Reference level • Cooling fan operation mode and speed • Brightness of various displays • Contrast of channel screens | page 36 |
| | Media Manage | Display and format media data | page 200 |
| | All System Data | Save, load, back up and restore data for entire mixer | page 186 |
| | Clock Adjust | Set date and time of built-in clock | page 33 |
| | Version Information | View system version information | page 201 |
| | Firmware Update | Update the firmware | page 201 |
| Recorder / Player | Recorder / Player | Use built-in recorder/player | page 204 |
| | Multi Track Recorder | Use IF-MTR32 (multitrack recording) card installed in SLOT 1 or SLOT 2 on the rear panel NOTE In the following circumstances, this sub menu item will appear gray and the MULTI TRACK RECORDER Screen will not open even if it is tapped. <ul style="list-style-type: none"> • When no IF-MTR32 is installed • When the IF-MTR32 is being initialized | page 216 |
| Save Current Settings | | Save current mixer settings in built-in memory (We recommend doing this before turning the unit off) | page 97 |

3 – Preparation

Installing expansion cards (sold separately)

ATTENTION

Before installing or removing an expansion card (sold separately), disconnect the power cord from the outlet or the unit.

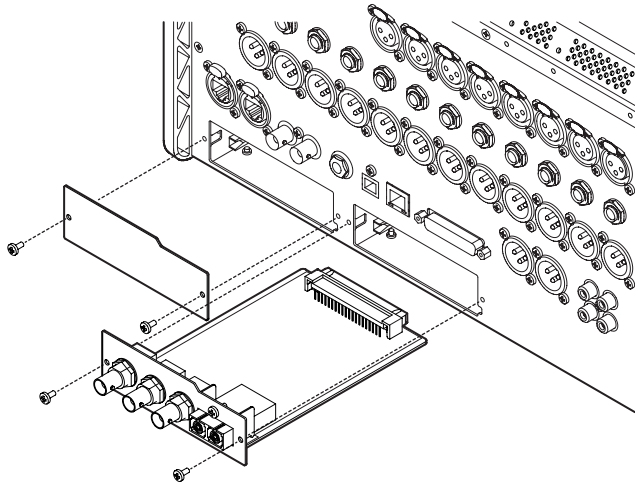

1. Remove the two screws from the plain panel and remove the panel itself. (If a different card is already installed, remove it.)
2. Insert the expansion card into the card slot. Align the edges of the expansion card with the white guides inside the slot and insert it securely. Push the expansion card in until its backplate reaches the rear panel of the unit, leaving no gap, and clicks into place. Do not force the card into the slot. If you cannot insert the card properly, remove it once and try reinserting it.
3. Use the two removed screws to secure the expansion card.
4. Turn the unit on, and check Menu Screen > Rear Panel Setup > SLOT SETUP screen to confirm that it has recognized the installed expansion card. (See "SLOT SETUP screen" on page 92.)

If "SLOT 1 (None)" or something similar appears, the expansion card might not be installed correctly or the screws might not be tightened securely. Insert the expansion card securely into the unit again.

Turning the power on and off

CAUTION

- Turn down the volume of the sound system connected to the unit before starting up or shutting down the unit.
- Do not wear connected headphones when turning the unit on and off. Loud noises could damage the speakers or harm your hearing.

Before turning the power on

1. Minimize output faders along with monitor out and headphone volumes on this unit.
2. Minimize the output levels of audio sources and input levels of amplifiers connected to this unit.

Turning the power on

1. Use the POWER switch on the back of the unit to turn its power on.
After the unit starts and the startup screen is shown, the Home Screen will open.
2. Turn connected input audio source devices on.
3. Finally turn amplifiers on.

Turning the power off

Before turning the power off, minimize the levels of output faders along with monitor out and headphone volumes on this unit, and then follow the procedures above in reverse. Failure to follow the correct order could result in clicking noises, for example, that might damage equipment.

CAUTION

Do not turn the power off or disconnect the power cord when the unit is operating (including recording, playing back, writing data to an SD card or USB flash drive, or saving settings to the internal memory). Doing so could cause proper recording to fail, recorded data to be lost, and sudden loud noises from monitoring equipment, which might damage the equipment, harm hearing or cause other trouble.

NOTE

We recommend executing the Save Current Settings command on the Menu Screen before turning the unit off. (See "Saving the current settings" on page 97.)

Setting the built-in clock date and time

This unit records file creation dates and times using its internal clock.

In addition, built-in clock date and time data is also used for recording file names as well as for file names when saving various library data and All System Data, for example. For these reasons, we recommend setting the date and time accurately.

1. Tap Menu Screen > System Setup > Clock Adjust to open the CLOCK ADJUST Screen.

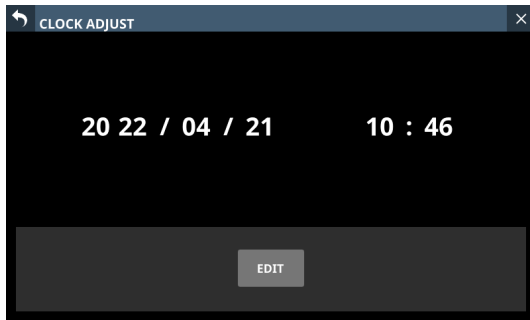

2. Tap the EDIT button to enable setting mode for this screen.

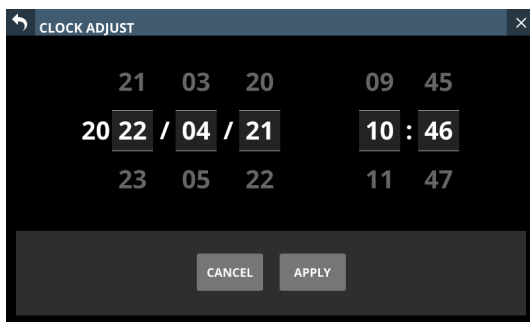

3. Swipe up and down to change values.
4. Tap the APPLY button to complete setting the date and time of the built-in clock.

NOTE

Tap the CANCEL button to exit setting mode.

Connecting and disconnecting SD cards and USB flash drives

SD cards and USB flash drives can be connected and disconnected whether the unit is on or off.

ATTENTION

Never disconnect an SD card or USB flash drive when it is being accessed, such as in the cases listed below. Doing so could cause proper recording to fail, data to be lost, and sudden loud noises from monitoring equipment, which might damage the equipment, harm hearing or cause other trouble. Moreover, disconnecting during a firmware update could result in the unit becoming unable to start up or operate properly.

- Recording (SD cards only)
- Playing back
- During IMPORT/EXPORT of snapshot data

- During BACKUP/RESTORE of All System Data
- During firmware updates (See “Firmware update procedures” on page 201.)
- When an SD card or USB flash drive is being accessed with the BROWSE screen

NOTE

- Insert an SD card into the SD card slot on the top of the unit so that its label faces right.
- To remove an SD card, press it in gently to make it to come out and then pull it out completely.

SD card write protection switches

SD cards have write-protection switches that prevent writing new data to them.

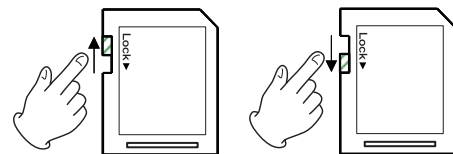

If you slide the write-protection switch to the “LOCK” position, writing will not be possible. Move the write-protection switch to the unlocked position in order to record, erase and otherwise edit data on the card.

This unit also writes settings data for recording/playback folders on these media. Since setting information cannot be written to write-protected SD cards, settings for recording/playback folders will not be retained when the unit is restarted and performance will be otherwise affected.

Preparing SD cards and USB flash drives for use

Always use this unit to format the SD cards and USB flash drives to be used with it. (See “Media Manage Screen” on page 200.) Operation of this unit might be affected when using an SD card or USB flash drive that has been formatted by a computer or other device.

ATTENTION

- Formatting erases all the data on the SD card or USB flash drive.
- SD cards formatted by this unit are optimized to improve performance during recording. Use this unit to format the SD cards to be used with it. Errors might occur when recording with this unit using an SD card formatted by a computer or other device.

4 – Mixer configuration and settings

SYNC CLOCK screen

On this screen, the status of each audio clock is shown and audio synchronization settings and word clock output jack output mode settings can be made.

Tap Menu Screen > System Setup > Sync Clock to open this screen.

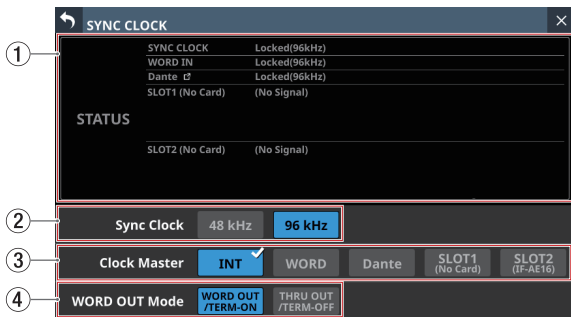

① STATUS display area

This shows the status of each audio clock.

| Item | Explanation |
|------------|---|
| SYNC CLOCK | This shows the synchronization status of this unit with the master clock (Locked/Unlocked/Regained) and the operation frequency (96kHz/48kHz/No Signal). |
| WORD IN | This shows the synchronization status of this unit with the WORD signal input through the WORD IN jack (Locked/Unlocked/Regained) and the operation frequency (actual measured value/No Signal). |
| Dante | This shows the synchronization status of this unit with the connected Dante system (Locked/Unlocked/Regained) and the operation frequency (actual measured value/No Signal). Tap the icon to open the Dante Settings page of the Dante Setup Screen. |
| SLOT1 | These show the names of the expansion cards in SLOT 1 and 2 and the synchronization statuses of this unit with them (Locked/Unlocked/Regained) and the operation frequency (actual measured value/No Signal). |
| SLOT2 | |

NOTE

The operation frequency will not be shown for SLOT 1 or SLOT 2 if it has an IF-MTR32 (multitrack recording) card installed.

② Sync Clock buttons

These set the synchronization clock frequency of the digital input and output signals.

The selected button will be highlighted light blue.

Options: 48 kHz, 96 kHz (default)

NOTE

- This unit will always operate internally at 96 kHz even when synchronized to a master clock that is 48 kHz.
- Synchronization is possible even if the built-in Dante "Sampling rate" and the main unit "Sync Clock" settings are different.
- Synchronization is not possible if the IF-DA64 (Dante) card "Sampling rate" is 44.1 or 88.2 kHz.

- If the IF-DA64 (Dante) card "Sampling rate" is 48 or 96 kHz, synchronization is possible even if the main unit "Sync Clock" setting is different. (Set the IF-DA64 (Dante card) "Sampling rate" with Dante Controller.)
- When the Clock Master is Dante, if the "Sampling rate" setting and Dante sampling rate are different, the following values will be shown for the operation frequency of the SYNC CLOCK.

- When the internal Dante "Sampling rate" is "96 kHz" and Sync Clock is "48 kHz", half the internal Dante measured value
- When the internal Dante "Sampling rate" is "48 kHz" and Sync Clock is "96 kHz", twice the internal Dante measured value

③ Clock Master buttons

These set the master clock used by this unit for audio synchronization. (default: INT)

- A mark appears on the master clock being used.
- If the selected master clock is locked, the select button will be highlighted light blue.
- If Sync Clock is "48 kHz" when the internal Dante "Sampling rate" is "96 kHz", "1/2" will be shown at the top right of the Dante button.
- If Sync Clock is "96 kHz" when the internal Dante "Sampling rate" is "48 kHz", "x2" will be shown at the top right of the Dante button.
- If the "Sampling rate" of an IF-DA64 (Dante) card installed in SLOT 1 or SLOT 2 is "96kHz" and Sync Clock is "48kHz", "1/2" will be shown at the top right of the corresponding SLOT button.
- If the "Sampling rate" of an IF-DA64 (Dante) card installed in SLOT 1 or SLOT 2 is "48kHz" and Sync Clock is "96kHz", "x2" will be shown at the top right of the corresponding SLOT button.
- If the selected external clock is unlocked, the unit will operate using the internal clock. In this case the will be shown on the INT button as the clock in use, while is shown on the selected button for the unlocked source. The selected button for the unlocked source will be highlighted red.

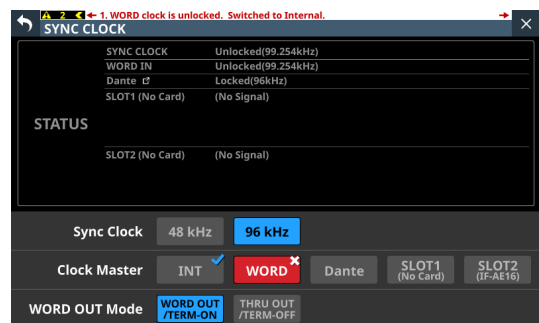

4 – Mixer configuration and settings

- If synchronization becomes possible with an external clock after synchronization with it failed (Regain state), the ✓ will be shown on the INT button as the clock in use, while ⚠ is shown on the selected button for the clock in a regain state. Tap the red-highlighted button with the ⚠ mark to open a confirmation message for switching back to the selected master clock.



Tap the OK button to switch to synchronization with the selected external clock.

④ WORD OUT Mode buttons

These set the output mode of the WORD THRU/OUT connector on the back of the unit. The selected button will be highlighted light blue.

| Option | Meaning |
|----------------------------|--|
| WORD OUT/TERM-ON (default) | This sets the signal output from the WORD/THRU OUT connector to WORD OUT and turns WORD IN connector termination resistance (75Ω) on. |
| THRU OUT/TERM-OFF | This sets the signal output from the WORD/THRU OUT connector to THRU output of the signal from the WORD IN connector and turns WORD IN connector termination resistance (75Ω) off. |

Setting the sampling frequency

1. Tap Menu Screen > System Setup > Sync Clock to open the SYNC CLOCK Screen.
2. Tap the button for the desired sampling frequency to set it. A confirmation message will appear.

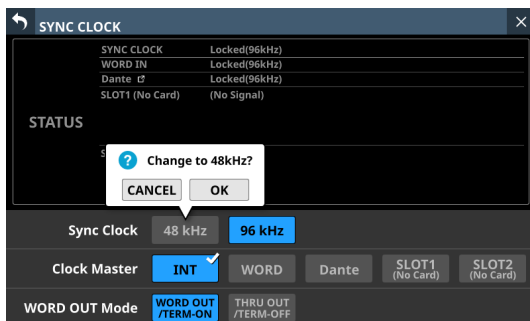

3. Tap the OK button to switch the sampling frequency.

ATTENTION

Switching the sampling frequency will mute the sound for a few seconds. Be aware of this timing when switching.

Setting the master clock

The unit's master clock can be set.

ATTENTION

When connecting multiple digital audio devices, set up the system so that it uses only one master clock.

1. Tap Menu Screen > System Setup > Sync Clock to open the SYNC CLOCK Screen.
2. Tap the button for the desired master clock to set it. A confirmation message will appear.

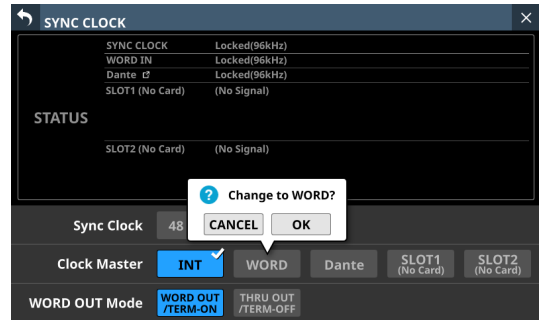

| Button | Use |
|---------|---|
| INT | The unit's internal clock is used. |
| WORD IN | Synchronize with the word clock signal input through the WORD IN connector. |
| Dante | Synchronize with the clock of a connected Dante system. |
| SLOT1 | Synchronize with the digital signal clock received through SLOT 1. |
| SLOT2 | Synchronize with the digital signal clock received through SLOT 2. |

3. Tap the OK button to switch the master clock.

NOTE

- If the SLOT 1 or SLOT 2 button is tapped when an IF-AE16, IF-AN16/OUT or IF-MTR32 is installed in SLOT 1 or SLOT 2, or if no expansion card has been installed in that slot, the following message will appear and the master clock will not be selected.

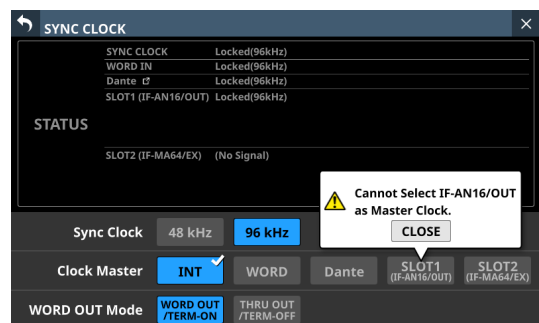

4 – Mixer configuration and settings

- If the selected external clock is unlocked, the unit will operate using the internal clock. In this case the ✓ will be shown on the INT button as the clock in use, while ✗ is shown on the selected button for the unlocked source. The selected button for the unlocked source will be highlighted red.

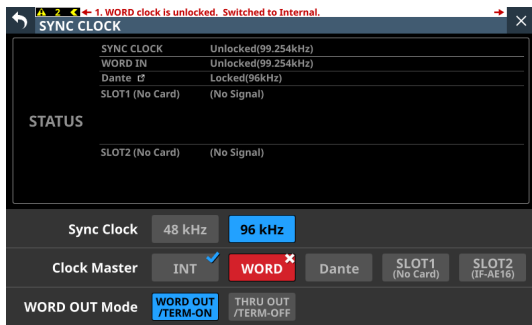

- When synchronization with the external master clock becomes possible again, a message like the one below will appear at the top of all touchscreens.

WORD clock regained. Can be re-synced to WORD.

Tap this message to open the SYNC CLOCK Screen on the right touchscreen.

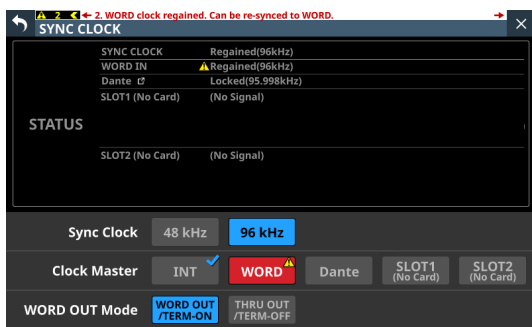

Tap the red-highlighted button with the ⚠ mark to open a confirmation message for switching back to the selected master clock.

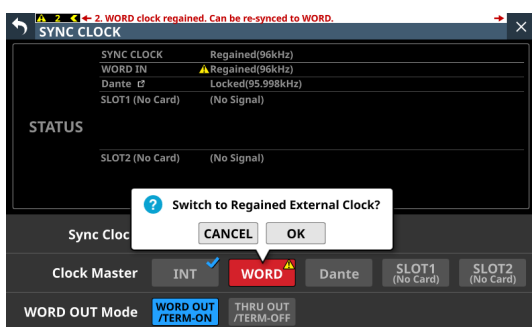

Tap the OK button to switch to synchronization with the selected external clock.

ATTENTION

When switching the master clock, noise might occur in the audio input and output. Be aware of this when choosing when to change the master clock.

PREFERENCES screen

Make settings and view information as follows on this screen.

- USB Keyboard type setting
- Snapshot STORE/RECALL confirmation setting
- Digital Reference Level setting
- Analog Reference Level setting
- Cooling fan operation mode and speed settings
- Cooling fan operation status display
- Temperature value and status display for various locations
- Brightness settings for the various displays
- Contrast settings for the channel screens

Tap any of the following menu screens to open this screen.

- "Brightness" in the Front Panel Setup menu
- LAMP Dimmer Setup in the Rear Panel Setup menu
- Preferences in the System Setup menu

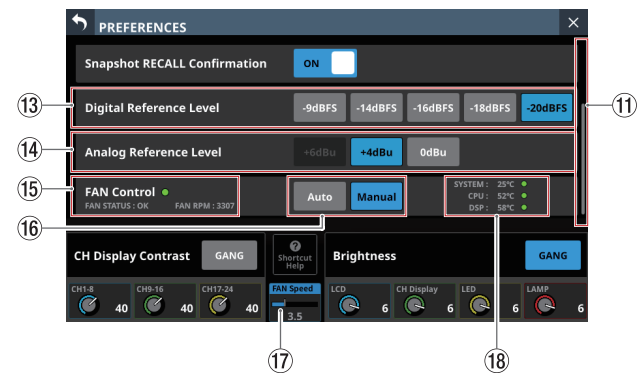
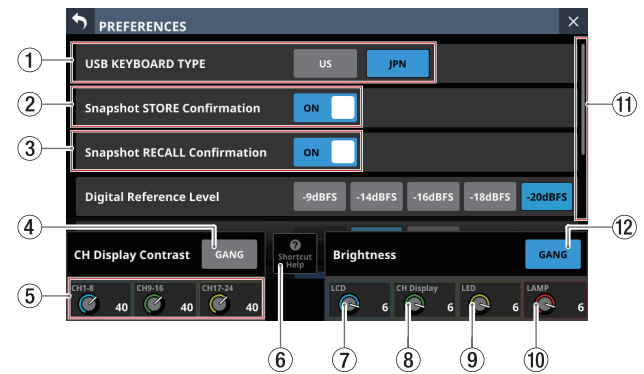

① USB KEYBOARD TYPE buttons

Set the type of USB keyboard connected to the USB port on the top of the unit.

The selected button will be highlighted.

| Button | Meaning |
|---------------|---------------------|
| US | US English keyboard |
| JPN (default) | Japanese keyboard |

4 – Mixer configuration and settings

② Snapshot STORE Confirmation switch

Set whether or not to show a confirmation message when storing snapshots.
When on, the sliding switch will appear highlighted.

NOTE

This can also be set by tapping the  icon in the Snapshot function item area at the top of the Menu Screen and opening the CONFIRMATION settings window. (See "Snapshot functions" on page 170.)

③ Snapshot RECALL Confirmation switch

Set whether or not to show a confirmation message when recalling snapshots.
When on, the sliding switch will appear highlighted.

NOTE

This can also be set by tapping the  icon in the Snapshot function item area at the top of the Menu Screen and opening the CONFIRMATION settings window. (See "Snapshot functions" on page 170.)

④ CH Display Contrast GANG button

This turns the Channel Screen contrast adjustment knob GANG function on or off (default).
When the GANG function is on, the button will appear highlighted.

When the GANG function is on, operating any LCD knob 1–3 will cause the contrast settings of all to follow, maintaining set differences.

⑤ CH Display Contrast knobs

Use these to adjust the contrasts of the channel screens.

Range: 0 – 60 (default: 40)

- Turn an LCD knob to adjust 1 step at a time.
- Press and turn an LCD knob to adjust 4 steps at a time.

| | |
|------------|------------------------------------|
| LCD knob 1 | Channels 1–8 |
| LCD knob 2 | Channels 9–16 |
| LCD knob 3 | Channels 17–24 (Sonicview 24 only) |

NOTE

By turning an LCD knob while pressing the MENU key on the top of the unit, the contrast of the channel screen that corresponds to that knob can be adjusted. (See "13 – List of shortcut operations" on page 244.)

⑥ Shortcut Help button

Tap this button to open a window that explains shortcut operations for adjusting the contrast of channel screens and brightness of the various displays.

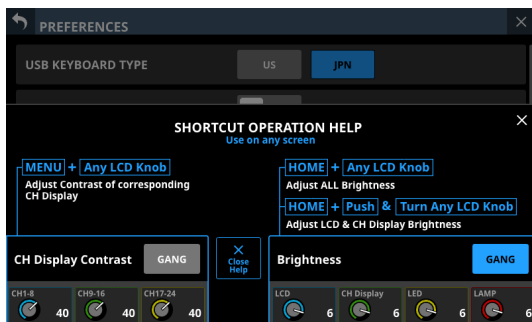

Tap  at the top right of the SHORTCUT OPERATION HELP window or the Close Help button to close it.

⑦ LCD brightness knob

Turn LCD knob 5 (lit blue) to adjust the touchscreen brightness.

Range: 0 – 7 (default 6)

⑧ CH Display brightness knob

Turn LCD knob 6 (lit green) to adjust the channel screen brightness.

Range: 0 – 7 (default 6)

⑨ LED brightness knob

Turn LCD knob 7 (lit yellow) to adjust the indicator brightness.

Range: 0 – 7 (default 6)

⑩ LAMP brightness knob

Turn LCD knob 8 (lit red) to adjust the brightness of the lamp connected to the LAMP connector on the rear panel.

Range: 0 – 7 (default 6)

⑪ Scroll bar display

This scroll bar shows the position of the setting items currently shown on the screen relative to all items on the PREFERENCES Screen.

NOTE

To view setting items not shown on the screen, swipe the setting items area up and down to scroll the screen.

⑫ Brightness GANG button

This turns the brightness knobs GANG function on (default) and off.

When the GANG function is on, the button will appear highlighted.

When the GANG function is on, operating any LCD knob 5–8 will cause the brightness settings of all to follow, maintaining set differences.

⑬ Digital Reference Level buttons

Use these to set the digital reference level.

The selected button will be highlighted.

Options: -9dBFS, -14dBFS, -16dBFS, -18dBFS, -20dBFS (default)

⑭ Analog Reference Level buttons

Use these to set the analog reference level.

The selected button will be highlighted.

Options: +6dBu, +4dBu (default), 0dBu

NOTE

Depending on the Digital Reference Level button setting, selection of some Analog Reference Level buttons will not be possible.

Buttons that cannot be selected will appear dark gray.

| | | Analog Reference Level | | |
|-------------------------|---------|------------------------|-------|------|
| | | +6dBu | +4dBu | 0dBu |
| Digital Reference Level | -9dBFS | ○ | × | × |
| | -14dBFS | × | ○ | × |
| | -16dBFS | × | ○ | × |
| | -18dBFS | × | ○ | ○ |
| | -20dBFS | × | ○ | ○ |

○ : Selectable

× : Not selectable

4 – Mixer configuration and settings

15 FAN Status

This shows the cooling fan operation status and rotation speed.

| Indicator | FAN STATUS | Meaning |
|-----------|------------|----------------|
| Green | OK | Normal |
| Red | FAILURE | Malfunctioning |

16 FAN Control buttons

Use these to set the internal cooling fan operation mode. The selected button will be highlighted.

| Button | Meaning |
|----------------|--|
| Auto (default) | Cooling fan operation will be controlled automatically. |
| Manual | FAN Speed (17) will be shown and the user can set cooling fan operation. |

17 FAN Speed

When the operation mode of the cooling fan is "Manual", its rotation speed can be adjusted.

Range: 1.0 – 10.0 (36 levels, default: 3.5)

Turn LCD knob 4 (lit blue) to adjust it.

18 Temperature Status

These show the temperature values of the SYSTEM (internal temperature), CPU and DSP.

| Indicator | Meaning |
|-----------------------|------------------------------------|
| Green | Temperature is within normal range |
| ⚠ with orange WARNING | Temperature is not in normal range |

METER screen

View various meters and make settings for them on this screen. Tap Menu Screen > Mixer Setup > Meter to open this screen.

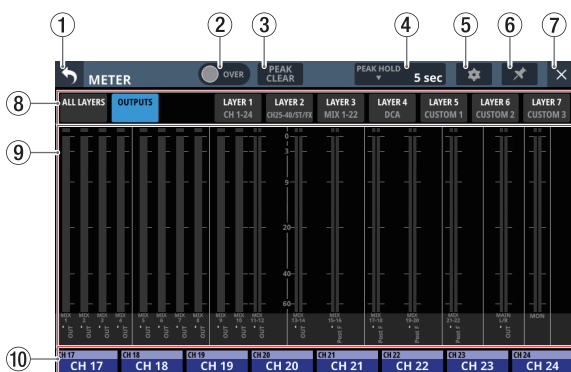

NOTE

Using the User Defined Control function, this screen can also be opened with a USER KEY, footswitch or the GPIO-IN. (See "USER DEFINED CONTROLS screen" on page 44.)

1 button

Tap this button to return to the Menu Screen.

NOTE

If the ✖ button (6) on this screen appears highlighted (✖), tapping this button will not return to the Menu Screen.

2 OVER Indicator

- This will appear highlighted red if the signal level at a metering point of any module has overloaded. This will continue to appear highlighted for the PEAK HOLD time (4) set on this screen.
- Tap this area to clear the highlighting of this indicator and the overload indicators of all level meters.

NOTE

They will appear to light red when the level reaches or exceeds -0.00026 dBFS (16-bit full-scale value).

3 PEAK CLEAR button

Tap this button to clear the peak hold indicators for the following level meters.

- Peak indicators that are held below overload levels
- Overload indicators for all level meters

NOTE

The OVER indicator (2) on this screen will not be cleared.

4 PEAK HOLD time display

- This shows the level meter peak hold time.
- Tap this area to open a window where the level meter peak hold time can be set.

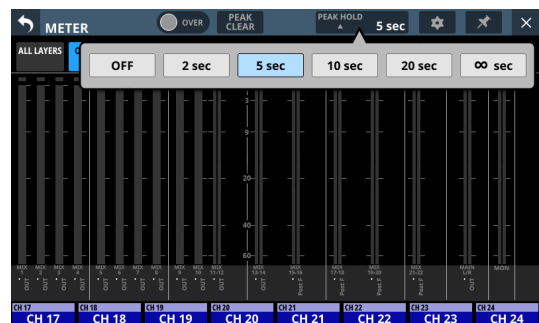

Options: OFF(no hold), 2 sec, 5 sec (default), 10 sec, 20 sec, ∞ sec (hold until cleared)

5 gear button

Tap this button to open the METER SETUP Screen. (See "METER SETUP screen" on page 40.)

4 – Mixer configuration and settings

⑥ ✖ button

- Tap this button, highlighting it, to disable the METER Screen (①) and ✖ (⑦) buttons as shown below and prevent the METER Screen from being closed.

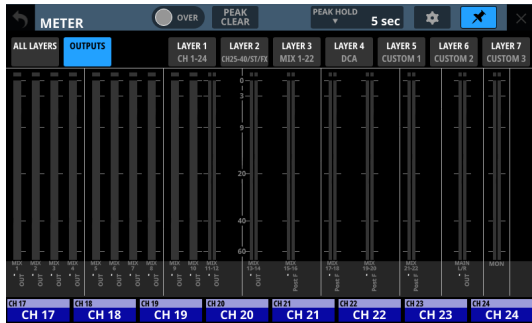

In this state, the METER Screen will stay open even if the HOME key on the top of the unit is pressed. The screen can still be switched, however, by conducting the following operation.

- Tap the ✖ (⑤) button to open the METER SETUP Screen.
- Press the MENU key on the top panel to switch to the Menu Screen.
- Press the HOME and MENU keys together to open the LOCK SETUP Screen.
- Press the SEL key on the top panel to switch to the MODULE Screen.
- Tap the Home Screen NAME area (⑩) at the bottom of this screen to open the MODULE (OVERVIEW) Screen.
- Tap the ✖ button when it is highlighted (✖) to open a confirmation message.

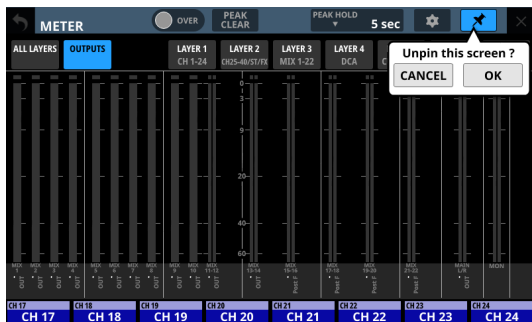

Tap the OK button to end highlighting of the ✖ button, enabling closing of the METER Screen.

⑦ ✖ button

Tap this button to return to the Home Screen.

NOTE

If the ✖ button (⑥) on this screen appears highlighted (✖), tapping this button will not return to the Home Screen.

⑧ Page selection buttons

- The button for the currently selected page is highlighted and corresponding level meters are shown in the meter area (⑨).
- Tap one of these buttons to switch to showing the corresponding level meters.

⑨ Meter Area

- The level meters are shown for the page with the highlighted selection button.

| Page name | Contents |
|------------|---|
| ALL LAYERS | This shows level meters for the modules assigned to all of the 7 layers on one line per layer. User module names (names set by user) are shown at the bottom of the level meters. |
| OUTPUTS | This shows level meters for MIX 1–22 and MAIN L/R Master modules and the MONITOR OUT. The module names, user module names and metering points are shown below the level meters. |
| LAYER1 | This shows level meters for the modules assigned to the corresponding layer. The module names, user module names and metering point names are shown below the level meters. |
| LAYER2 | |
| LAYER3 | |
| LAYER4 | |
| LAYER5 | |
| LAYER6 | |
| LAYER7 | |

- Two meters will be shown for stereo modules.
- Each level meter has an overload indicator at its top. They will appear to light red when the signal level reaches or exceeds -0.00026 dBFS (16-bit full-scale value).
- When a level overload occurs, the entire bar meter will light red.
- The area below -60 dBFS at the bottom of the level meters will light when above -70 dBFS.

⑩ Home screen name area

- This shows the same information as the NAME area on the Home Screen for modules assigned to the right touchscreen on the current layer (module name, user module name, Mute Group assignment).
- Tap this area to open the MODULE (OVERVIEW) Screen. (See "MODULE (OVERVIEW) Screen" on page 116.)

4 – Mixer configuration and settings

METER SETUP screen

Make the following settings on this screen.

- **METERING POINT** page
Set the metering points for each module type.
- **METER HEADROOM** page
Set the point where level meter colors change on each screen.

Tap on the METER Screen to open this screen.

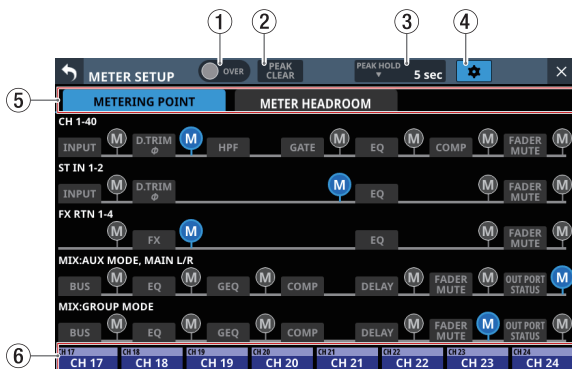

1 OVER Indicator

This has the same function as the OVER indicator on the METER Screen. (See “METER screen” on page 38.)

2 PEAK CLEAR button

This has the same function as the PEAK CLEAR button on the METER Screen. (See “METER screen” on page 38.)

3 PEAK HOLD time display

This has the same function as the PEAK HOLD time display on the METER Screen. (See “METER screen” on page 38.)

4 button

Tap this button to return to the METER Screen. (See “METER screen” on page 38.)

5 Page selection buttons

Tap these buttons to switch the page shown.

6 Home screen name area

This shows the NAME area of the right touchscreen Home Screen. (See “METER screen” on page 38.)

METERING POINT page

Set the metering points for each module type on this page.

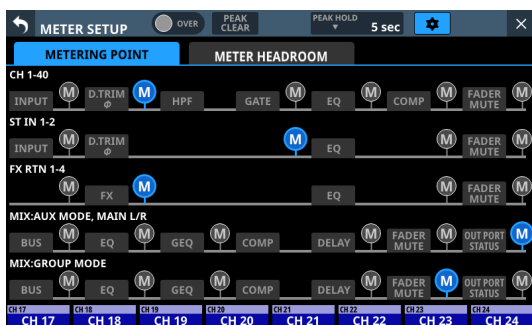

Tap icons to set metering points.

When a metering point is selected, that icon will appear highlighted .

| Module type | default |
|---|------------|
| CH 1–40 module | PRE HPF |
| ST IN 1–2 module | PRE EQ |
| FX RTN 1–4 module | FX OUTPUT |
| MIX 1–22 and MAIN L/R Master modules when the BUS mode is AUX | OUTPUT* |
| MIX 1–22 modules when the BUS mode is GROUP | POST FADER |

* Metering Point “OUTPUT” setting explanation

For the following module types, this is the Metering Point setting when the icon to the right of “OUT PORT STATUS” is lit ().

- MIX: AUX MODE, MAIN L/R
- MIX: GROUP MODE

NOTE

- These can also be set on the MODULE (OVERVIEW) screens for each module using Metering Point buttons. (See “MODULE (OVERVIEW) Screen” on page 116.)
- When the Metering Point is OUTPUT*, and the corresponding bus has not been assigned to an output port (not being output from the unit), meters will not be shown.

METER HEADROOM page

On this page, set the point where level meter colors change on each screen.

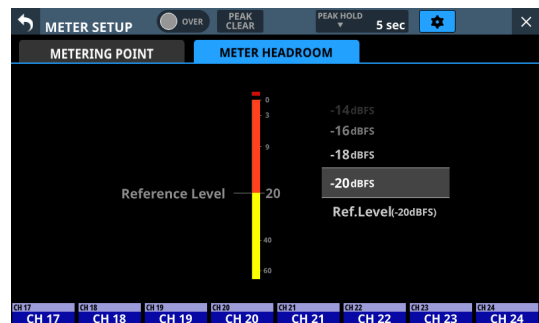

Options: -9dBFS, -14dBFS, -16dBFS, -18dBFS, -20dBFS, Ref. Level (default)

Swipe the options up and down to select the point where colors change.

4 – Mixer configuration and settings

LOCK SETUP screen

On this screen, set the lock function to prevent this unit from being controlled from its front panel or an external device.

1. Press and hold the HOME and MENU keys on the top panel together for 5 seconds to open the LOCK SETUP Screen on the right touchscreen.

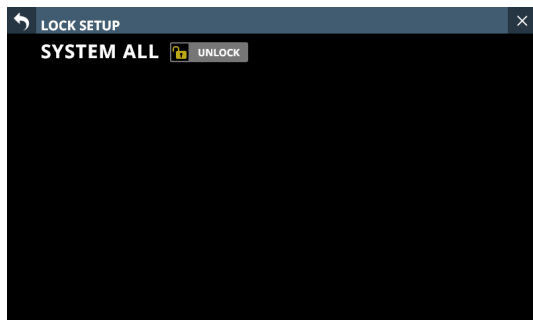

2. Tap this button to lock and unlock.
The button will be highlighted when set to "LOCK".

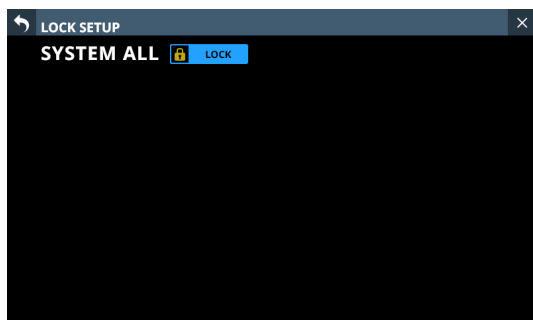

3. Tap the  button to return to the Home Screen.

NOTE

- When SYSTEM ALL is set to "LOCK", operation from all locked items will be prohibited.
- Attempts to operate or control when set to "LOCK" will cause a message to appear on all touchscreens for about two seconds.



Lockable controls and operations

- LCD touchscreen operations (except the LOCK SETUP Screen)
- LCD knob operations
- Fader operations
- Top panel key operations (except pressing HOME and MENU keys simultaneously)
- Operations from a network
- Footswitch operations
- GPIO-IN operations
- The following controls and operations will not be locked.
 - Headphone volume
 - MONITOR OUT volume
 - TALKBACK volume
 - POWER switch
 - Pressing HOME and MENU keys simultaneously
 - Touchscreen operations on the LOCK SETUP Screen

4 – Mixer configuration and settings

MIXER CONFIG screen

Make the following settings on this screen.

- CH 1–40 CONFIG page
 - CH 1–40 stereo link settings
 - DIRECT OUT POINT settings
 - DELAY POINT settings
 - INSERT POINT unified settings
- BUS CONFIG page
 - BUS MODE settings
 - MIX 1–22 stereo link settings
 - Pan link settings

Tap Menu Screen > Mixer Setup > Mixer Config/Bus Config to open this screen.

CH 1–40 CONFIG page

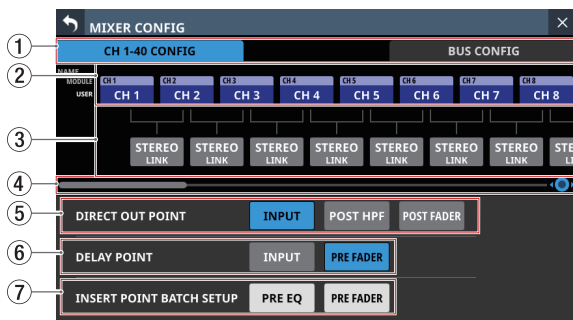

① Page selection buttons

Tap these buttons to switch the page shown.

② CH 1–40 module name button area

- This shows the module names and user module names for the CH 1–40 modules.
- Tap these buttons to open the MODULE NAME Screen where the user module name and set module color can be changed. (See “MODULE NAME screen” on page 166.)

③ STEREO LINK button area

- These show the stereo link settings states of the CH 1–40 modules.
- Tap these buttons to turn the stereo link setting on and off (default) for the CH 1–40 modules. When the stereo link is on, the button will appear highlighted.

④ Scroll knob and scrollbar

Drag the scrollbar left and right to show CH 1–40 modules that are not shown on the screen. The screen can also be scrolled by turning LCD knob 8.

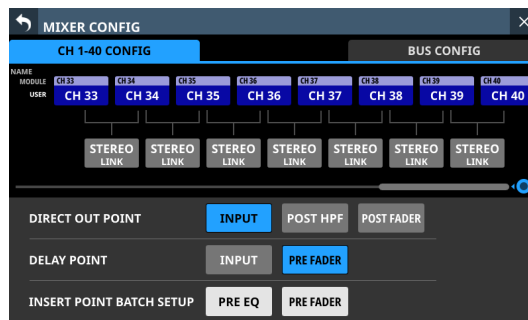

NOTE

The screen can also be scrolled by swiping left and right between the CH 1–40 module NAME area (②) and the STEREO LINK button area (③).

⑤ DIRECT OUT POINT buttons

Tap these buttons to change all direct out points for the CH 1–40 modules at the same time.

Options: INPUT (default), POST HPF, POST FADER

⑥ DELAY POINT buttons

Tap these buttons to change the delay function insert position for the CH 1–40 modules at the same time.

⑦ INSERT POINT BATCH SETUP buttons

These change all the insert points at once for the CH 1–40 modules, which can be set individually on the MODULE (OVERVIEW) Screen.

Tapping a button will open a setting change confirmation message.

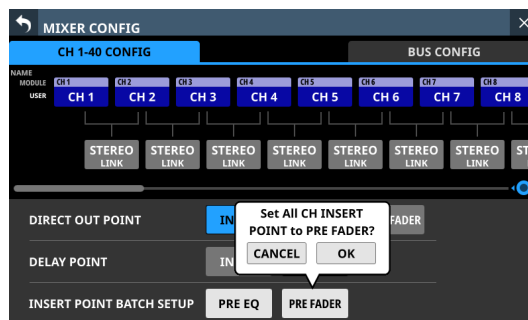

Tap the OK button to change the insert points for all CH 1–40 modules at the same time.

4 – Mixer configuration and settings

BUS CONFIG page

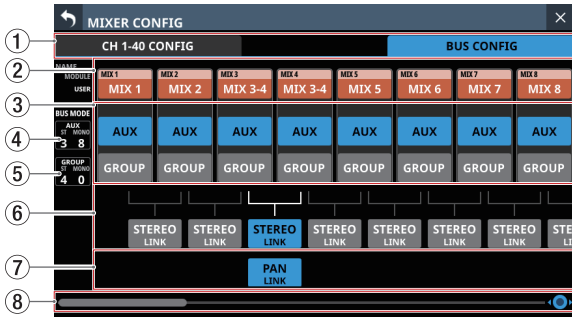

① Page selection buttons

Tap these buttons to switch the page shown.

② MIX 1–22 MODULE NAME area

- This shows the module names and user module names for the MIX 1–22 modules.
- Tap these buttons to open the MODULE NAME Screen where the user module name and set module color can be changed. (See “MODULE NAME screen” on page 166.)

③ BUS MODE area

Tap these buttons to change the bus modes of MIX 1–22 modules.

| Button | Function |
|--------|--|
| AUX | Set the MIX bus that corresponds to the button to function as an AUX bus. SEND level, on/off and PRE/POST settings can be made from each module to AUX mode buses. (PRE/POST is only for input modules.) |
| GROUP | Set the MIX bus that corresponds to the button to function as a GROUP bus. Only on/off can be set for modules to GROUP mode buses. They are always sent POST FADER. |

NOTE

- When BUS is changed from GROUP to AUX, the setting color of corresponding MIX 1–22 modules will change to orange.
- When BUS is changed from AUX to GROUP, the setting color of corresponding MIX 1–22 modules will change to purple.

④ AUX bus counts

This shows the number of modules set to AUX in the BUS MODE area.

- “ST” shows the number of AUX mode module pairs that have the stereo link setting on.
- “MONO” shows the number of AUX mode modules that have the stereo link setting off.

⑤ GROUP bus counts

This shows the number of modules set to GROUP in the BUS MODE area.

- “ST” shows the number of GROUP mode module pairs that have the stereo link setting on.
- “MONO” shows the number of GROUP mode modules that have the stereo link setting off.

⑥ STEREO LINK button area

- These show the stereo link settings states of the MIX 1–22 modules.
- Tap these buttons to turn the stereo link setting on/off for the MIX 1–22 modules. When the stereo link is on, the button will appear highlighted.

⑦ PAN LINK button area

These buttons appear when MIX 1–22 module stereo link settings are on and the BUS mode is AUX.

When the PAN LINK setting is on, the AUX bus pan/balance (SEND PAN) setting is linked to the MAIN L/R bus pan/balance setting.

⑧ Scroll knob and scrollbar

Drag the scrollbar left and right to show MIX 1–22 modules that are not shown on the screen. The screen can also be scrolled by turning LCD knob 8.

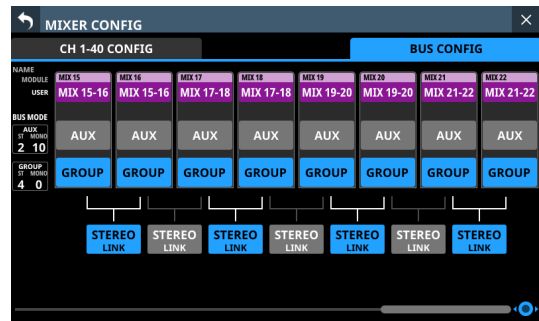

NOTE

The screen can also be scrolled by swiping left and right between the MIX 1–22 module NAME area (②) and the PAN LINK button area (⑦).

4 – Mixer configuration and settings

USER DEFINED CONTROLS screen

The following settings can be made on this screen.

- **User Key page**
Functions can be assigned to USER KEY A–F and USER KEY 1–12.
Tap Menu Screen > Front Panel Setup > User Key Setup to open this page.
- **Foot Switch page**
Functions can be assigned to the footswitch.
Tap Menu Screen > Rear Panel Setup > FOOT SW Setup to open this page.
- **GPIO-IN page**
Functions can be assigned to the GPIO input connector of this unit or of an SB-16D connected through the built-in Dante.
Tap Menu Screen > Rear Panel Setup > GPIO Input Setup to open this page.
- **GPIO-OUT page**
Functions can be assigned to the GPIO output pins of an SB-16D connected to this unit or through the built-in Dante.
Tap Menu Screen > Rear Panel Setup > GPIO Output Setup to open this page.

The settings for keys and connectors are made in operation setting tables on each page.

Tap one of the four page selection buttons to open that page. (See “USER DEFINED CONTROLS screen structure” on page 51.)

The functions that can be assigned on these pages are as follows.





User Key, Foot Switch and GPIO-IN pages

| Function | Parameter1 | Parameter2 | Parameter3 | Function explanation | |
|----------------|---------------|------------|-----------------|---|---------------------|
| Tap Tempo | FX1–4 | Delay1–3 | | Use to tap the tempo to input the DELAY TIME when the selected effect type is DELAY. (See “MODULE (FX) Screen” on page 132.) When the effect type is any delay other than “DELAY LCR”, set Parameter 2 to “Delay 1”. When the effect type is “DELAY LCR”, set Parameter 2 as follows. | |
| | | | | Desired parameter | Parameter 2 setting |
| | | | | DELAY TIME L | Delay1 |
| | | | | DELAY TIME C | Delay2 |
| | | | | DELAY TIME R | Delay3 |
| Mute Group | 1–8 | | | Turn the selected Mute Group on/off. (See “Mute Group Master page” on page 165.) | |
| Sends On Fader | Mix1–22/FX1–4 | | | Turn the Sends On Fader mode for the selected bus on/off. (See “SENDS ON FADER screen” on page 152.) | |
| Snapshot | Select | Next | | Increase by one the number of the Snapshot available for STORE/RECALL shown at the top of the Menu Screen. (See “Snapshot functions” on page 170.) | |
| | | Prev | | Decrease by one the number of the Snapshot available for STORE/RECALL shown at the top of the Menu Screen. (See “Snapshot functions” on page 170.) | |
| | | No | 1-128/P001-Pxxx | This makes the specified Snapshot number shown at the top of the Menu Screen the target for STORE/RECALL. (See “Snapshot functions” on page 170.) | |

4 – Mixer configuration and settings

| Function | Parameter1 | Parameter2 | Parameter3 | Function explanation | |
|----------|------------|-------------|-----------------|---|--|
| Snapshot | Recall | Selected | | Recall the Snapshot available for RECALL shown at the top of the Menu Screen. (See "Snapshot functions" on page 170.) | |
| | | Next | | Switch the number of the Snapshot available for RECALL shown at the top of the Menu Screen to the Snapshot that is one later, and then recall it. (See "Snapshot functions" on page 170.) | |
| | | Prev | | Switch the number of the Snapshot available for RECALL shown at the top of the Menu Screen to the Snapshot that is one earlier, and then recall it. (See "Snapshot functions" on page 170.) | |
| | | No | 1-128/P001-Pxxx | Recall a snapshot by number. (See "Snapshot functions" on page 170.) | |
| | | +Target Key | | Press this simultaneously with a key that has Function set to Snapshot and Parameter 1 set to Target to recall that set snapshot number. (See "Snapshot functions" on page 170.) | |
| | Store | Selected | | Store the Snapshot available for STORE shown at the top of the Menu Screen. (See "Snapshot functions" on page 170.) | |
| | | No | 1-128 | Store a snapshot by number. (See "Snapshot functions" on page 170.) | |
| | | +Target Key | | Press this simultaneously with a key that has Function set to Snapshot and Parameter 1 set to Target to store in that set snapshot number. (See "Snapshot functions" on page 170.) However, even when Function is set to Snapshot and Parameter 1 is set to Target, this will not work if the key assigned to Parameter 2 as "Next" or "Prev" is pressed at the same time. | |
| | Target | Selected | | Press simultaneously with a key assigned to a +Target Key function to STORE to or RECALL from the Snapshot number shown at the top of the Menu Screen. | |
| | | Next | | Press simultaneously with a key assigned to a +Target Key function to make the Snapshot number target for STORE/RECALL one after that shown at the top of the MENU Screen subject to RECALL. | |
| | | Prev | | Press simultaneously with a key assigned to a +Target Key function to make the Snapshot number target for STORE/RECALL one before that shown at the top of the MENU Screen subject to RECALL. | |
| | | No | 1-128/P001-Pxxx | Press simultaneously with a key assigned to a +Target Key function to STORE to or RECALL from the specified Snapshot number. | |
| | Undo/Redo | Undo Color | Redo Color | | Undo/redo Snapshot RECALL operations. (See "Snapshot functions" on page 170.) When undoing is possible, the USER KEY that this function is assigned to will light in the color set by Parameter 2: Undo Color. When redoing is possible, the USER KEY that this function is assigned to will light in the color set by Parameter 3: Redo Color. (Parameters 2 and 3 can only be set to USER KEY.) |

4 – Mixer configuration and settings

| Function | Parameter1 | Parameter2 | Parameter3 | Function explanation |
|-----------------------|--|---|------------|--|
| Screen | TALKBACK/ OSCILLATOR | | | Show the TALKBACK/OSCILLATOR page of the MONITOR SETUP Screen on the rightmost touchscreen and light the corresponding USER KEY. When this screen is open, pressing a corresponding USER KEY will close it. |
| | METER | ALL LAYER OUTPUT LAYER1-7 LAST TAB | | Show the page of the METER Screen specified by Parameter 2 on the rightmost touchscreen and light the corresponding USER KEY. When this screen is open, pressing a corresponding USER KEY will close it. |
| | RECORDER/PLAYER | | | Show the RECORDER PLAYER Screen on the right touchscreen and light the corresponding USER KEY. When this screen is open, pressing the corresponding USER KEY will close it. |
| | Multi Track Recorder | | | Show the MULTI TRACK RECORDER Screen on the right touchscreen and light the corresponding USER KEY. When this screen is open, pressing a corresponding USER KEY will close it. |
| Talkback | ON/OFF | | | Turn the talkback mic on/off. (See “Making talkback and built-in oscillator settings” on page 62 and “  TALKBACK key and indicator” on page 12.) |
| Monitor Source Select | Monitor Select 1-6 | | | Select a specific number for Monitor Select. (See “  MONITOR SELECT buttons” on page 59.) |
| Monitor Control | MUTE | | | Turn monitoring signal muting on/off. (See “  Monitor MUTE button” on page 59.) |
| | DIM | | | Turn monitoring signal dimming on/off. (See “  Monitor DIM button” on page 59.) |
| SEND ON/OFF | CH 1-40 ST IN 1-2 FX RTN 1-4 MIX 1-22 MAIN L/R | MIX 1-22 FX 1-4 | | This turns ON/OFF the SEND from the module specified with Parameter 1 to the bus specified with Parameter 2. The key will light when this setting is on. |
| MTR | REC | | | This has the following functions, which are the same as the  button on the MULTI TRACK RECORDER Screen. <ul style="list-style-type: none"> • Press this when stopped and at least one REC READY is on to put the unit into recording standby. • If the MTR operation mode is LIVE RECORDING MODE, pressing this when recording will not interrupt recording, but it will end the current take and start a new take (take splitting). • When the MTR operation mode is LIVE RECORDING MODE or VIRTUAL SOUND CHECK MODE, press this when in recording standby to start a new take and remain in recording standby. • When the MTR operation mode is OVERDUB MODE and at least one REC READY is on, press this when playing to punch in and start recording. • The key lights when recording. • The key blinks when recording is paused. • The key is unlit when stopped or playing back. |

4 – Mixer configuration and settings

| Function | Parameter1 | Parameter2 | Parameter3 | Function explanation |
|----------|--------------|------------|------------|--|
| MTR | PLAY | | | <p>This has the following functions, which are the same as the ► button on the MULTI TRACK RECORDER Screen.</p> <ul style="list-style-type: none"> • Press this when stopped or paused to start playback. • Press this when recording is paused to resume recording. • The indicator lights when recording or playing. • The key is unlit when stopped. |
| | STOP | | | <p>This has the following functions, which are the same as the ■ button on the MULTI TRACK RECORDER Screen.</p> <ul style="list-style-type: none"> • Press when recording/playing to stop recording/playing. • The key lights when stopped. |
| | PAUSE | | | <p>This has the following functions, which are the same as the ■■ button on the MULTI TRACK RECORDER Screen.</p> <ul style="list-style-type: none"> • Press this when stopped or playing to pause playback. • When the MTR operation mode is LIVE RECORDING MODE or VIRTUAL SOUND CHECK MODE, press this when recording to pause recording. • This cannot be used during recording when the MTR operation mode is OVERDUB MODE. • The key lights when recording or playback is paused. |
| | REWIND | | | <p>This has the following functions, which are the same as the ◀ (REW) button on the MULTI TRACK RECORDER Screen.</p> <ul style="list-style-type: none"> • When stopped, playing back or playback is paused, press this key to start searching backward. Press and hold this key to search while it is being pressed. • Press this key when searching backward to stop. • This key lights when searching backward. |
| | FAST FORWARD | | | <p>This has the following functions, which are the same as the ▶▶ (F.FWD) button on the MULTI TRACK RECORDER Screen.</p> <ul style="list-style-type: none"> • When stopped, playing back or playback is paused, press this key to start searching forward. Press and hold this key to search while it is being pressed. • Press this key when searching forward to stop. • This key lights when searching forward. |

4 – Mixer configuration and settings

| Function | Parameter1 | Parameter2 | Parameter3 | Function explanation |
|----------|----------------|------------|------------|--|
| MTR | TAKE SKIP PREV | | | <p>This has the following functions, which are the same as tapping the ◀◀◀ (TO TOP/SKIP PREV.) and ◀ (TO TOP) buttons on the MULTI TRACK RECORDER Screen.</p> <p>When the MTR operation mode is LIVE RECORDING MODE or VIRTUAL SOUND CHECK MODE:</p> <ul style="list-style-type: none"> • Press this when playing or paused to return to the beginning of the current take. • Press this when a take is stopped at its beginning to skip to the beginning of the previous take. • The key lights when skipping. <p>When the MTR operation mode is OVERDUB MODE:</p> <ul style="list-style-type: none"> • Tap this when stopped, playing or paused to return to the beginning of the take. • The key lights when skipping. |
| | TAKE SKIP NEXT | | | <p>This has the following functions, which are the same as tapping the ▶▶▶ (SKIP NEXT) and ▶ (TO END) buttons on the MULTI TRACK RECORDER Screen.</p> <p>When the MTR operation mode is LIVE RECORDING MODE or VIRTUAL SOUND CHECK MODE:</p> <ul style="list-style-type: none"> • Tap this when stopped, playing or paused to skip to the next take. • The key lights when skipping. <p>When the MTR operation mode is OVERDUB MODE:</p> <ul style="list-style-type: none"> • Tap this when stopped, playing or paused to skip to the end of the take. • The key lights when skipping. |
| | MARK SKIP PREV | | | <p>This has the following functions, which are the same as tapping the ◀ MARK SKIP button on the MULTI TRACK RECORDER Screen.</p> <ul style="list-style-type: none"> • Press this key to move to the position of the nearest mark that is before the current playback position. |
| | MARK SKIP NEXT | | | <p>This has the following functions, which are the same as tapping the ▶ MARK SKIP button on the MULTI TRACK RECORDER Screen.</p> <ul style="list-style-type: none"> • Press this key to move to the position of the nearest mark that is after the current playback position. |
| | Undo/Redo | Undo Color | Redo Color | <p>This has the following functions, which are the same as tapping the UNDO/REDO button on the MULTI TRACK RECORDER Screen.</p> <ul style="list-style-type: none"> • Press when the key is the Parameter 2 UNDO color (blue by default) to undo. • Press when the key is the Parameter 3 REDO color (orange by default) to redo. • When this key is unlit, UNDO and REDO are not possible. |
| | Punch IN/OUT | | | <p>Use this to punch in/out in the MULTI TRACK RECORDER.</p> <p>When the MTR operation mode is OVERDUB MODE and at least one REC READY is on, press this when playing to punch in and start recording.</p> <p>Press during recording to punch to punch out and continue playback.</p> |

4 – Mixer configuration and settings

| Function | Parameter1 | Parameter2 | Parameter3 | Function explanation |
|----------|-------------|-------------|------------|--|
| MTR | SET MARK | | | This has the following functions, which are the same as tapping the SET MARK button on the MULTI TRACK RECORDER Screen. <ul style="list-style-type: none"> • Pressing this key sets a mark at the current recording/playback time. • The key will light while being pressed. |
| | SOUND CHECK | SOUND CHECK | | This has the same function as tapping the SOUND CHECK button on the MULTI TRACK RECORDER Screen. <ul style="list-style-type: none"> • This key will light when SOUND CHECK mode is ON. |
| | | YES | | Pressing this button when an MTR SOUND CHECK confirmation message is shown has the same function as tapping the YES button in that message. |
| | IN-OUT | SET IN | | This has the same function as tapping the SET IN button on the MULTI TRACK RECORDER Screen. <ul style="list-style-type: none"> • This key will light when an IN point is set. |
| | | SET OUT | | This has the same function as tapping the SET OUT button on the MULTI TRACK RECORDER Screen. <ul style="list-style-type: none"> • This key will light when an OUT point is set. |
| | | I-O CLEAR | | This has the same function as tapping the CLEAR button on the MULTI TRACK RECORDER Screen. <ul style="list-style-type: none"> • The key will light while being pressed. |
| | REPEAT | | | This has the same function as tapping the repeat mode setting button on the MULTI TRACK RECORDER Screen. <ul style="list-style-type: none"> • This key will light when the repeat mode is not OFF. |
| | REHEARSAL | | | This has the same function as tapping the REHEARSAL button on the MULTI TRACK RECORDER Screen. <ul style="list-style-type: none"> • This key will light when REHEARSAL mode is ON. • This will only function when the MTR operation mode is OVERDUB MODE. |

NOTE

- Foot Switch: GPIO-IN:
 - When Mute Group, Talkback, Monitor Control and SEND ON/OFF functions are assigned, the selected function will be activated while a Low level signal is being input. Moreover, if the same function is assigned to multiple GPIO-IN and/or footswitches, the function will be activated when any one of those signals is Low level. The function will be deactivated only when all the signals from the assigned GPIO-IN and/or footswitches are High level (OR operation).
 - When other functions are assigned, the selected function will operate if a Low level signal of 50 ms or longer is input.
- Snapshots stored with this function are named "USER KEY" followed by a three-digit slot number (for example, "USER KEY 018").
- When the Function is set to Snapshot and Parameter 2 is set to No, if Parameter 3 matches the current Snapshot number, the corresponding USER KEY will light.
- When a USER key with an MTR function set is operated, the MULTI TRACK RECORDER Screen will open on the right touchscreen. When MTR operation mode is active, however, the MULTI TRACK RECORDER Screen will not open if it does not have a button with the corresponding function.

4 – Mixer configuration and settings

GPIO-OUT page

| Function | Parameter1 | Parameter2 | Parameter3 | Function explanation |
|------------------|--|------------|------------|---|
| Fader Start | CH 1–40 ST IN 1–2 FX RTN 1–4 MIX 1–22 MAIN L/R | | | A pulse signal will be output when the status of the specified module becomes as follows (Active Low/150ms pulse width). <ul style="list-style-type: none"> ● When MUTE is off and the FADER level changes from below to above the fader start level setting value ● When the FADER level is above the fader start level setting value, and MUTE changes from on to off |
| Fader Stop | CH 1–40 ST IN 1–2 FX RTN 1–4 MIX 1–22 MAIN L/R | | | A pulse signal will be output when the status of the specified module becomes as follows (Active Low/150ms pulse width). <ul style="list-style-type: none"> ● When MUTE is off, and the FADER level changes from above to below the fader start level setting value ● When the FADER level is above the fader start level setting value and MUTE changes from off to on |
| Fader Start/Stop | CH 1–40 ST IN 1–2 FX RTN 1–4 MIX 1–22 MAIN L/R | | | When MUTE is off for the specified module and the FADER level is above the fader start level setting value, LOW level signal output will be latched. |
| MTR Status | REC PLAY STOP PAUSE FF REW TAKE SKIP | | | These output the MTR status from the GPIO-OUT port. While selected, they output LOW level. |

4 – Mixer configuration and settings

USER DEFINED CONTROLS screen structure

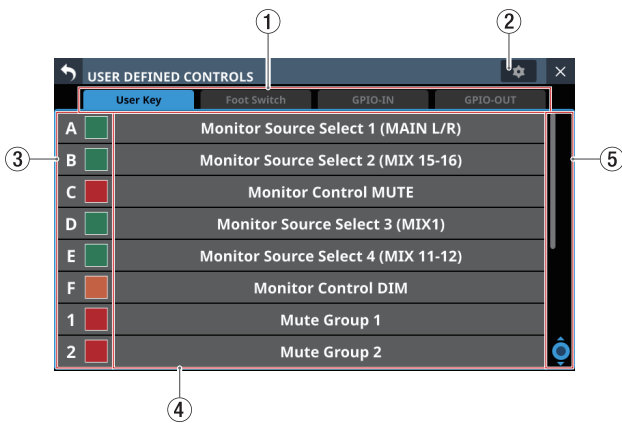

① Page selection buttons

Tap these buttons to switch the page shown.

② button

Tap this button to open a window where the footswitch polarity and fader start level can be set. (See "Setting the footswitch polarity" on page 53 and "Fader Start Level setting" on page 54.)

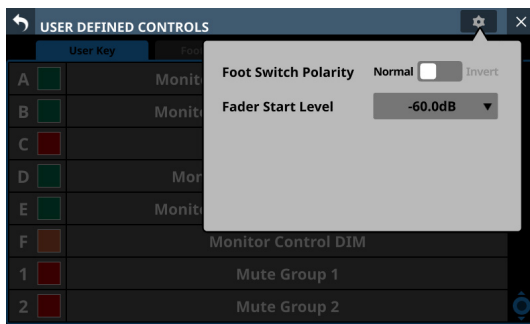

③ Control names and buttons (User Key page only)

The colors that USER KEY light when their functions are activated can be set.

Tap these buttons to open a color palette window.

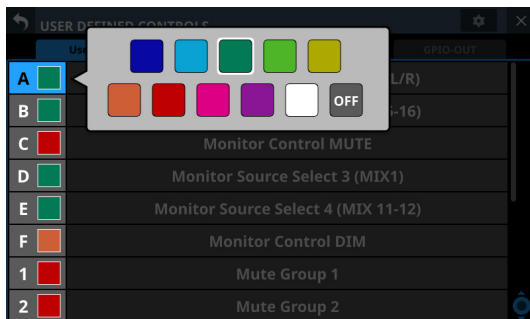

Tap a color in the color palette to close the window and change the control name display color.

④ Set function names

- The show the names of functions that have been assigned to the controls.
- Tap this area to open the control setting table for the controls.

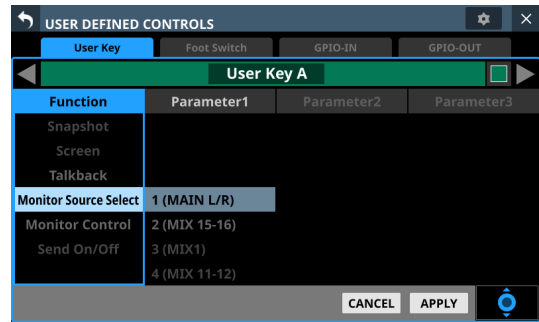

⑤ Scroll knob and scrollbar

These appear when all selectable options cannot be shown on the display at the same time.

Drag the bar to scroll the visible options. The options can also be scrolled by swiping up and down on the control name (③) and set function name (④) area as well as by turning LCD knob 8.

4 – Mixer configuration and settings

Control setting on USER DEFINED CONTROLS Screen

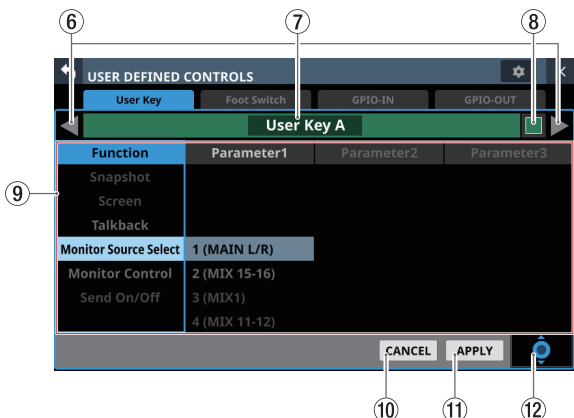

6 buttons

Tap these buttons to switch the control that is being edited.

7 **Control name area**

This shows the name of the currently selected control.

8 button (USER Key page only)

The colors that USER KEY light when their functions are activated can be set.

Tap these buttons to open a color palette window.

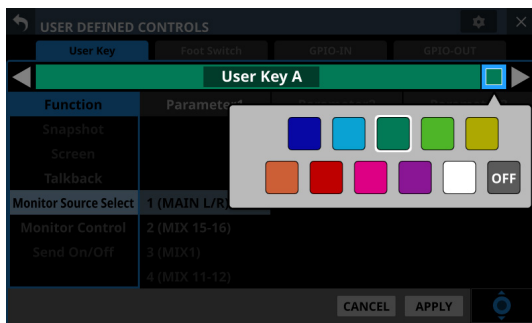

Tap a color in the color palette to close the window and change the control name display color.

9 **Function list**

- Functions that can be set for the controls and their parameters are shown in a 4-column list.
- Tap a column and select the setting to be changed. The selected column will be highlighted.
- To change a setting, swipe the list up and down in the highlighted column. The setting can also be changed by turning LCD knob 8 (lit light blue).

10 **CANCEL button**

Tap this button to cancel setting changes and return to the top USER DEFINED CONTROLS Screen.

11 **APPLY button**

Tap this button to apply setting changes and return to the top USER DEFINED CONTROLS Screen.

12 **Scroll knob icon**

This icon shows that LCD knob 8 (lit light blue) can be used to scroll.

User Key page

On this page, functions can be assigned to USER KEY A–F and USER KEY 1–12.

Tap Menu Screen > Front Panel Setup > User Key Setup to open this page.

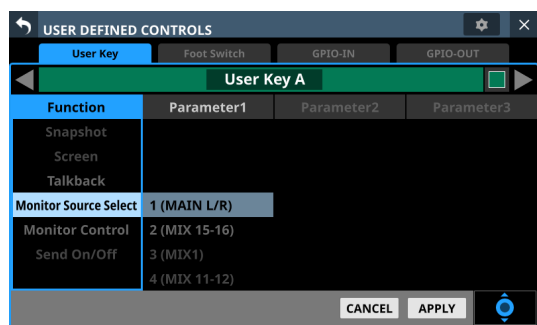
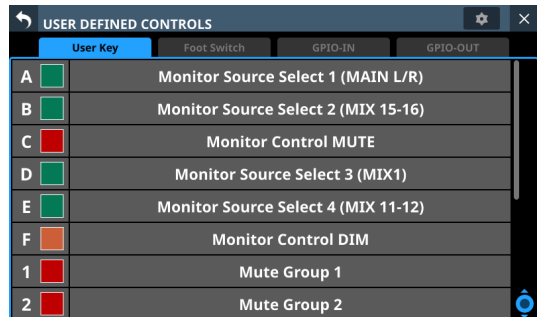

User Key page when setting controls

The factory default settings are as follows.

| Key | Lit color | Assigned function |
|-------------|-----------|------------------------------------|
| USER KEY A | Green | Monitor Source Select 1 (MAIN L/R) |
| USER KEY B | Green | Monitor Source Select 2 (MIX15–16) |
| USER KEY C | Red | Monitor MUTE |
| USER KEY D | Green | Monitor Source Select 3 (MIX1) |
| USER KEY E | Green | Monitor Source Select 4 (MIX11–12) |
| USER KEY F | Orange | Monitor DIM |
| USER KEY 1 | Red | Mute Group 1 |
| USER KEY 2 | Red | Mute Group 2 |
| USER KEY 3 | Red | Mute Group 3 |
| USER KEY 4 | Red | Mute Group 4 |
| USER KEY 5 | Orange | Sends On Fader Mix1 |
| USER KEY 6 | Orange | Sends On Fader Mix2 |
| USER KEY 7 | Orange | Sends On Fader Mix3 |
| USER KEY 8 | Orange | Sends On Fader Mix4 |
| USER KEY 9 | Orange | Sends On Fader Mix5 |
| USER KEY 10 | Orange | Sends On Fader Mix6 |
| USER KEY 11 | Orange | Sends On Fader Mix7 |
| USER KEY 12 | Orange | Sends On Fader Mix8 |

4 – Mixer configuration and settings

Foot Switch page

Functions can be assigned to the footswitch on this page. Tap Menu Screen > Rear Panel Setup > FOOT SW Setup to open this page.

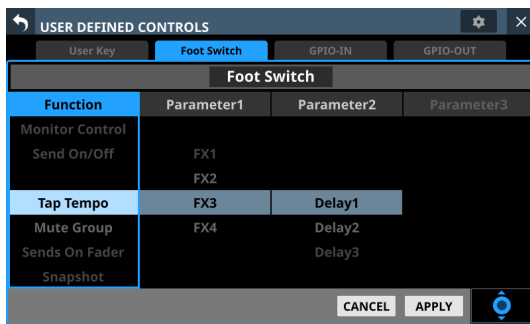
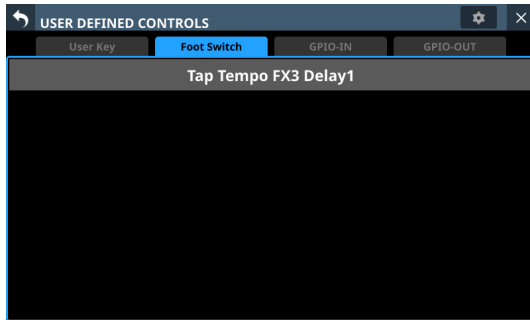

Foot Switch page when setting controls

The factory default setting is "Tap Tempo FX3 Delay1".

Setting the footswitch polarity

This unit was designed to be used with momentary footswitches that must be pushed to function (shorted when pushed). Since the polarity can be reversed, however, push-to-break (shorted with not pushed) footswitches can also be used.

The setting of this unit can be changed according to the polarity of the footswitch being used.

1. Tap the button on the USER DEFINED CONTROLS Screen to open a settings window.

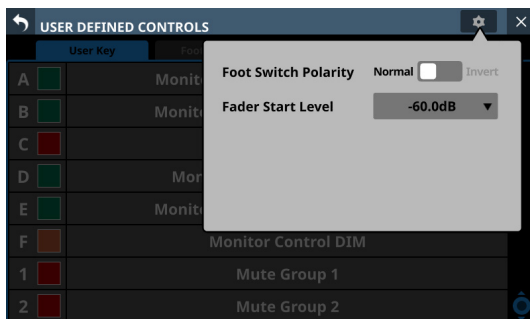

2. Tap the Foot Switch Polarity slider in the window to set the footswitch polarity.

Options: Normal (default), Invert

GPIO-IN page

On this page, functions can be assigned to the GPIO input connector of this unit or of a mounted SB-16D connected through the built-in Dante.

See "Using GPIO extension functions" on page 83 for details about using the GPIO connector of a mounted SB-16D.

Tap Menu Screen > Rear Panel Setup > GPIO Input Setup to open this page.

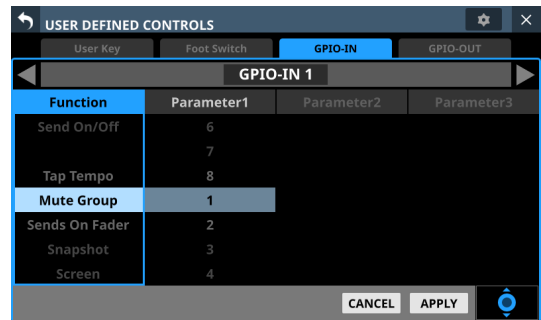
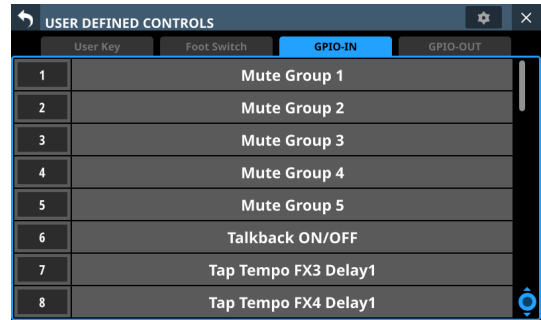

GPIO-IN page when setting controls

The factory default settings are as follows.

| Port number | Assigned function |
|-------------|----------------------|
| 1 | Mute Group 1 |
| 2 | Mute Group 2 |
| 3 | Mute Group 3 |
| 4 | Mute Group 4 |
| 5 | Mute Group 5 |
| 6 | Talkback ON/OFF |
| 7 | Tap Tempo FX3 Delay1 |
| 8 | Tap Tempo FX4 Delay1 |

NOTE

The GPIO input connector of a mounted SB-16D does not have functions assigned when shipped from the factory.

4 – Mixer configuration and settings

GPIO-OUT page

On this page, functions can be assigned to the GPIO output connector of this unit or of a mounted SB-16D connected through the built-in Dante.

See “Using GPIO extension functions” on page 83 for details about using the GPIO connector of a mounted SB-16D.

Tap Menu Screen > Rear Panel Setup > GPIO Output Setup to open this page.

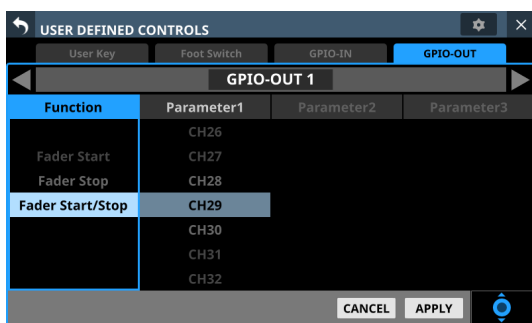
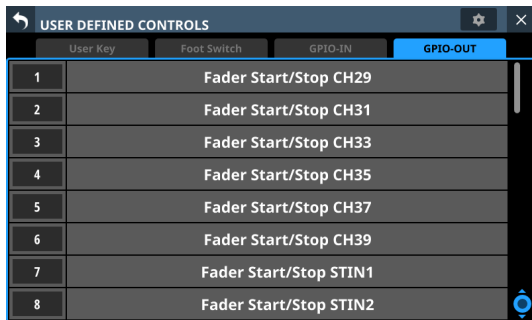

GPIO-OUT page when setting controls

The factory default settings are as follows.

| Port number | Assigned function |
|-------------|------------------------|
| 1 | Fader Start/Stop CH29 |
| 2 | Fader Start/Stop CH31 |
| 3 | Fader Start/Stop CH33 |
| 4 | Fader Start/Stop CH35 |
| 5 | Fader Start/Stop CH37 |
| 6 | Fader Start/Stop CH39 |
| 7 | Fader Start/Stop STIN1 |
| 8 | Fader Start/Stop STIN2 |

NOTE

The GPIO output connector of a mounted SB-16D does not have functions assigned when shipped from the factory.

Fader Start Level setting

This sets the trigger level of the fader start/stop function (default: -60 dB).

1. Tap the button on the USER DEFINED CONTROLS Screen to open a settings window.

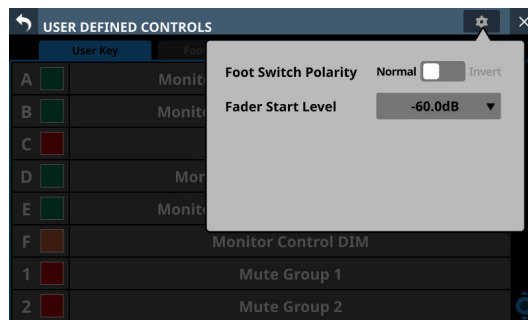

2. Tap the setting level value of the Fader Start Level item in the window to change its appearance as shown below. The Channel Screens also switch to showing fader start setting.

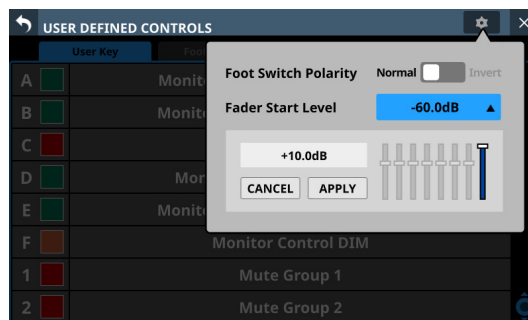

3. Adjust the channel faders on the right top panel to the desired start/stop trigger levels. The adjusted values are shown in the window.

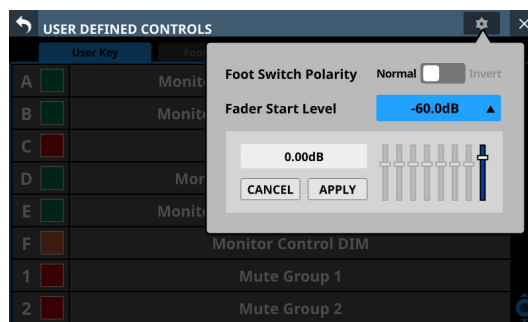

4. Tap the APPLY button to set the fader start level to the position of the corresponding fader, closing the window and returning to normal display.

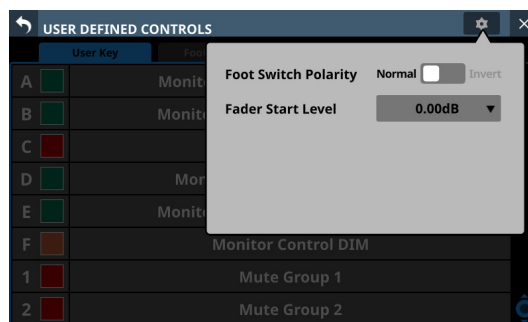

Tap the CANCEL button to close the window and return to normal display.

4 – Mixer configuration and settings

Layer Key SETUP page

Assign channel sets and custom layers to the 7 LAYER KEYS on this screen.

Tap Menu Screen > Front Panel Setup > Layer/Master Fader Setup to open this page.

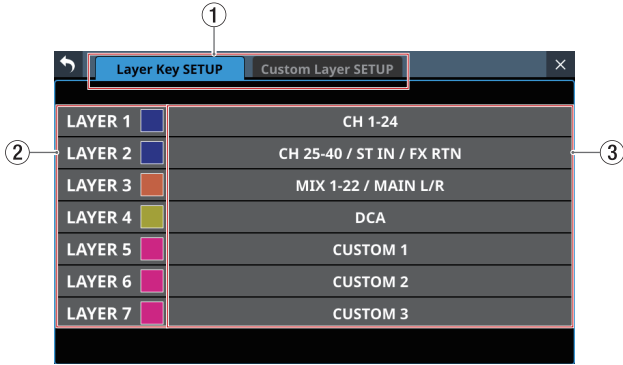

Sonicview 24 Layer Key SETUP Screen

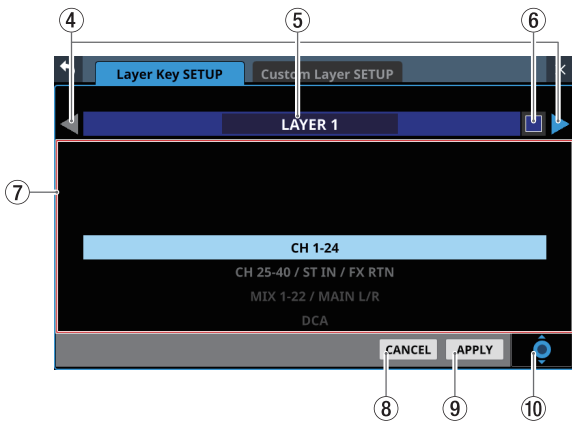

Layer Key SETUP layer key setting screen

① Page selection buttons

Tap these buttons to switch the page shown.

② Layer Key names

The colors that LAYER KEY 1-7 light when they are selected can be set.

Tap this area to open a color palette window.

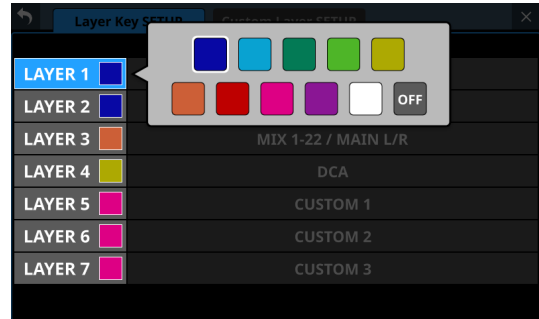

Tap a color in the color palette to change the layer key name button color and close the palette window.

③ Layer Key settings

- This shows channel sets and custom layers assigned to LAYER KEY 1-7.
- Tap this area to open a settings screen for the layer keys.

④ ◀▶ buttons

Tap these buttons to switch the LAYER KEY (1-7) that is being edited.

⑤ Layer Key name

This shows the name of the currently selected LAYER KEY (1-7).

⑥ ■ button

The colors that LAYER KEY 1-7 light when they are selected can be set.

Tap this button to open a color palette window.

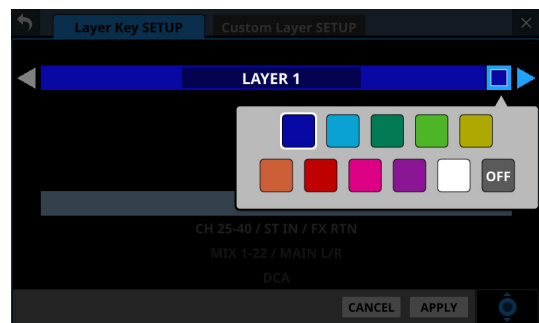

Tap a color in the color palette to change the layer key name display color and close the palette window.

4 – Mixer configuration and settings

⑦ Settings list

- This shows channel sets and custom layers that can be set for LAYER KEY 1–7.
- To change a setting, swipe the list up and down. The setting can also be changed by turning LCD knob 8 (lit blue).
- Settings that can be selected are as follows.

| Model | Option |
|--------------|---------------------------|
| Sonicview 16 | CH 1–16 |
| | CH 17–32 |
| | CH 33–40 / ST IN / FX RTN |
| | MIX 1–16 |
| | MIX 17–22 / MAIN L/R |
| | DCA |
| | CUSTOM 1 |
| | CUSTOM 2 |
| | CUSTOM 3 |
| | CUSTOM 4 |
| Sonicview 24 | CH 1–24 |
| | CH 25–40 / ST IN / FX RTN |
| | MIX 1–22 / MAIN L/R |
| | DCA |
| | CUSTOM 1 |
| | CUSTOM 2 |
| | CUSTOM 3 |
| | CUSTOM 4 |
| | CUSTOM 5 |
| | CUSTOM 6 |
| CUSTOM 7 | |

⑧ CANCEL button

Tap this button to cancel setting changes and close to the layer settings screen.

⑨ APPLY button

Tap this button to confirm setting changes and close to the layer settings screen.

⑩ Scroll knob icon

This icon shows that LCD knob 8 (lit light blue) can be used to scroll.

Default settings for LAYER KEY 1–7

The factory default settings are as follows.

Sonicview 16

| Key | Lit color | Assigned function |
|---------|-----------|---------------------------|
| LAYER 1 | Blue | CH 1–16 |
| LAYER 2 | Blue | CH 17–32 |
| LAYER 3 | Blue | CH 33–40 / ST IN / FX RTN |
| LAYER 4 | Orange | MIX 1–16 |
| LAYER 5 | Orange | MIX 17–22 / MAIN L/R |
| LAYER 6 | Yellow | DCA |
| LAYER 7 | Pink | CUSTOM 2 |

Sonicview 24

| Key | Lit color | Assigned function |
|---------|-----------|---------------------------|
| LAYER 1 | Blue | CH 1–24 |
| LAYER 2 | Blue | CH 25–40 / ST IN / FX RTN |
| LAYER 3 | Orange | MIX 1–22 / MAIN L/R |
| LAYER 4 | Yellow | DCA |
| LAYER 5 | Pink | CUSTOM 1 |
| LAYER 6 | Pink | CUSTOM 2 |
| LAYER 7 | Pink | CUSTOM 3 |

Custom Layer SETUP page

The modules assigned to custom layers and the modules assigned to the master fader can be set in the settings list on this screen.

Tap Menu Screen > Front Panel Setup > Layer/Master Fader Setup to open the Layer Key Setup page. Then, tap the Custom Layer Setup button to open this page.

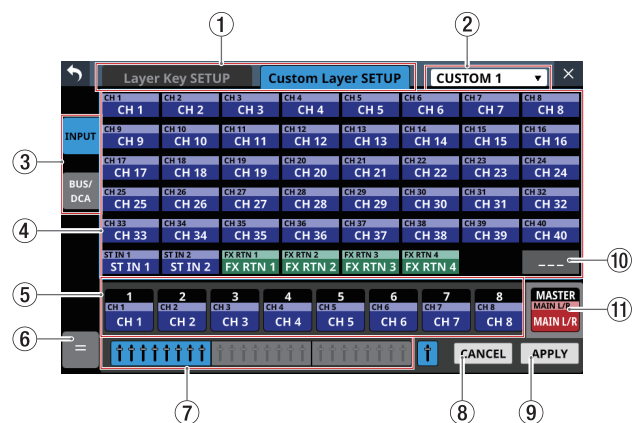

① Page selection buttons

Tap these buttons to switch the page shown.

4 – Mixer configuration and settings

② Custom Layer selection

- This shows the name of the custom layer that is being edited.
- Tap this area to open a window where the custom layer can be selected.

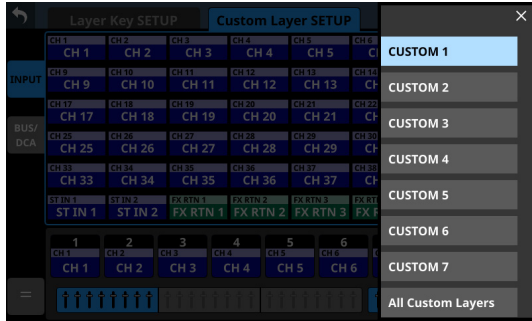

Tap the name of the custom layer to be edited to close this window and show the names of the modules assigned to the layer in the custom layer slot buttons (⑤).

- Tap “All Custom Layers” in the window to close the window and open the All Custom Layers display.

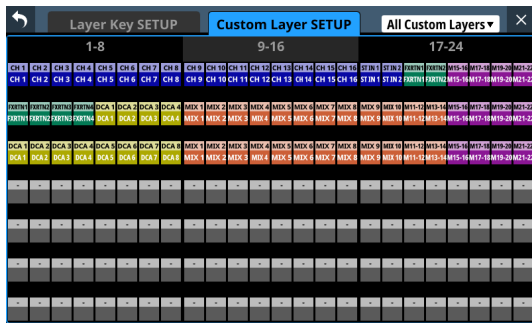

This shows the names of the modules assigned to all 7 custom layers on one line per layer.

Tap a button shown to switch to display of its custom layer.

③ Module group switching buttons

Tap these buttons to change which group of modules assigned to the layer is shown.

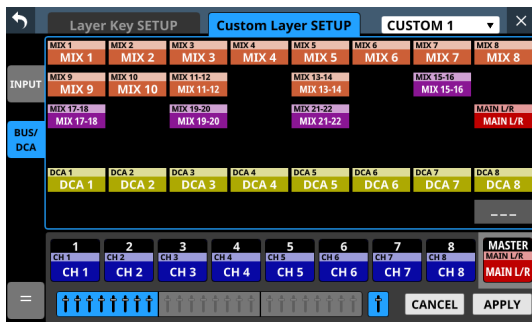

④ Module buttons

- These are the buttons for the modules in the group assigned to the layer.
- Use the module group switching buttons to select the shown group.

⑤ Custom layer slot buttons

In sets of 8, this shows the names of modules assigned to the custom layer that is being edited. Modules that are not assigned will appear blank (---).

Use the block selection buttons (⑦) to switch the 8 channels that are shown.

⑥ = button

Tap this button to open the custom layer editing menu.

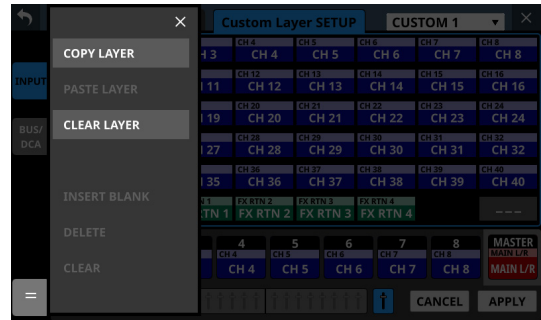

Items that can be used will be shown highlighted.

| Menu item | Function |
|--------------|---|
| COPY LAYER | This copies the setting state of the selected custom layer to a buffer. |
| PASTE LAYER | This pastes the custom layer setting state copied to the buffer to the selected custom layer. |
| CLEAR LAYER | This clears all the settings of the selected custom layer. A confirmation message will appear before clearing is executed. |
| INSERT BLANK | This inserts a blank at the position of the selected slot button (framed in yellow). When this is done, the contents assigned to the selected slot button and the slot buttons to its right will be shifted right. |
| DELETE | This deletes the assignment of the selected slot button (framed in yellow) and shifts left by one slot the settings to its right. Doing this causes the rightmost slot button to become blank. |
| CLEAR | This removes the assignment of the selected slot button (framed in yellow). This does not move any slot buttons. |

⑦ Block selection buttons

- The block selection button for the 8 channels that are shown is highlighted.
- Tap one of these buttons to switch the shown 8-channel block, which shows custom layer and slot buttons (④).

⑧ CANCEL button

Tap this button to cancel setting changes.

⑨ APPLY button

Tap this button to confirm setting changes.

⑩ --- button

Tap this button to make the assignment of the selected slot (framed in yellow) blank.

⑪ MASTER slot button

This shows the name of the module assigned to the MASTER fader (MAIN L/R by default) that does not depend on layer selection.

4 – Mixer configuration and settings

Custom layer assignment operation procedures

Selecting the custom layer slot button followed by the module button

1. Tap the custom layer slot button to select it for assignment change.
Selecting will make a yellow frame appear.

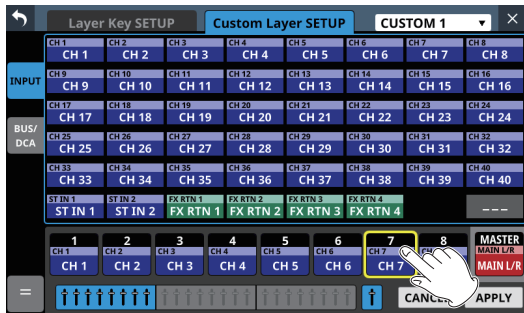

2. Tap the button for the module to be assigned to the selected slot.
This will assign the tapped module to the custom layer slot selected in step 1.

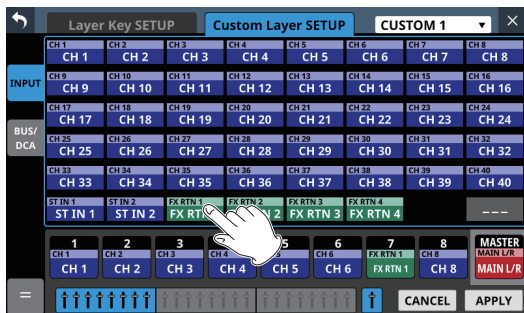

3. Tap the APPLY button to confirm setting changes.
Tap the CANCEL button to cancel setting changes.

Selecting the module button followed by the custom layer slot button

1. Tap the button for the module to be assigned.
Selecting will make a yellow frame appear.

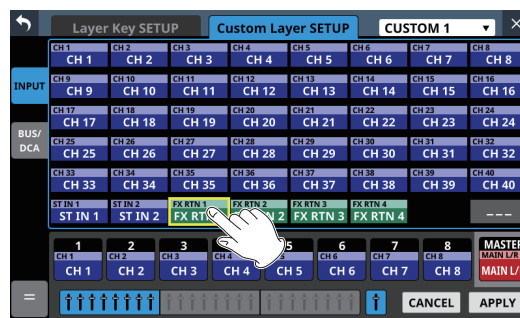

2. Tap the button for the custom layer slot to assign the selected module to it.
This will assign the module selected in step 1 to the tapped custom layer slot.

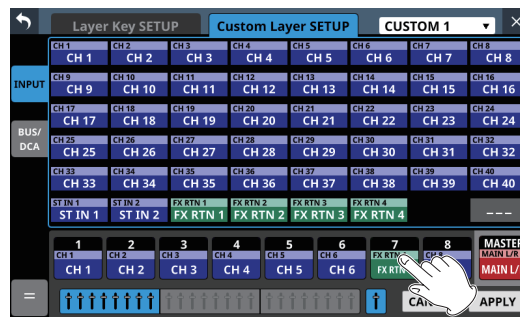

3. Tap the APPLY button to confirm setting changes.
Tap the CANCEL button to cancel setting changes.

NOTE

In either procedure, multiple buttons can be selected in step 1 and assigned consecutively at one time.

4 – Mixer configuration and settings

Making monitor output and solo function settings

Make monitor output and solo settings on the MONITOR/SOLO page of the MONITOR SETUP screen.

Tap Menu Screen > Mixer Setup > Monitor/Solo Setup to open this screen.

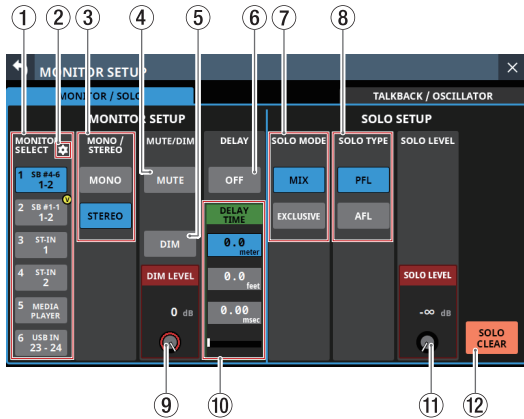

NOTE

This screen can also be opened by pressing either the SOLO or SOLO CLEAR key while pressing the MENU key. (See “13 – List of shortcut operations” on page 244.)

1 MONITOR SELECT buttons

- These show the names of the monitoring sources selected on the MONITOR SOURCE ASSIGN Screen. (See “MONITOR SOURCE ASSIGN screen” on page 61.)
- If a Dante port that has a mounted SB-16D assigned is selected as a monitoring source, “SB #[ID] [port number]” will be shown at the top of the button. If it is a virtually-mounted SB-16D, will appear to the top right.



- Tap these buttons to select one monitoring source for monitoring from the front panel headphone jacks and the rear panel MONITOR OUT L/R jacks. The selected button will be highlighted light blue.
- If the MONITOR SELECT button for a Dante port that has a virtually mounted SB-16D assigned is selected, the selected button will be highlighted yellow.



NOTE

- If a bus is selected as the monitoring source, sound output from the unit will be monitored. Monitoring will also be silent if the Metering Point setting is “OUTPUT” for the selected

bus but no assignment has been made to an output port (no external output from the unit). To monitor a bus AFL, use the SOLO function.

- Using the User Defined Control function, MONITOR SELECT 1–6 can also be operated with USER KEY, the footswitch or the GPIO-IN. (See “USER DEFINED CONTROLS screen” on page 44.)

The following USER KEY are set for MONITOR SELECT 1–4 on the User Key page by default.

- USER KEY A (Monitor Source Select 1 (MAIN L/R))
- USER KEY B (Monitor Source Select 2 (MIX15–16))
- USER KEY D (Monitor Source Select 3 (MIX1))
- USER KEY E (Monitor Source Select 4 (MIX11–12))

2 icon

Tap this icon to open the MONITOR SOURCE ASSIGN Screen. (See “MONITOR SOURCE ASSIGN screen” on page 61.)

3 MONO/STEREO buttons

Tap these buttons to switch between MONO and STEREO (default) for monitoring signals.

The selected button will be highlighted.

4 Monitor MUTE button

Tap this button to turn monitoring signal muting on and off (default).

When this is on, the button will appear highlighted.

NOTE

- Output from the headphone jacks will not be muted.
- Using the User Defined Control function, monitor muting can also be operated with a USER KEY, the footswitch or the GPIO-IN. (See “USER DEFINED CONTROLS screen” on page 44.)
- The following USER KEY is set for monitor muting on the User Key page by default.
 - USER KEY C (Monitor MUTE)

5 Monitor DIM button

Tap this button to turn the monitoring dimming function on and off (default).

When the monitor DIM function is on, the monitoring signal output level will be lowered according to the DIM LEVEL (**9**) setting.

When this is on, the button will appear highlighted.

NOTE

- This button affects the output signals of MONITOR OUT L/R and headphone jacks.
- Tap this button to turn it on and off. Touch this button continuously to turn the function on only while being touched.
- This is linked to turning talkback on and off.
- Using the User Defined Control function, monitor dimming can also be operated with a USER KEY, the footswitch or the GPIO-IN. (See “USER DEFINED CONTROLS screen” on page 44.)

The following USER KEY is set for monitor dimming on the User Key page by default.

- USER KEY F (Monitor DIM)

4 – Mixer configuration and settings

⑥ DELAY button

Tap this button to turn the delay function ON and OFF (default). This can be used to adjust the timing of the monitoring signal, for example.

When this is ON, the button will appear highlighted.

⑦ SOLO MODE buttons

Tap these buttons to set the solo function operation mode.

| Option | Meaning |
|---------------|---|
| MIX (default) | In solo mode, signals from modules that have their SOLO keys pressed are mixed for solo monitoring. |
| EXCLUSIVE | In solo mode, only the signal from the module that had its SOLO key pressed last is used for solo monitoring. |

The selected button will be highlighted.

⑧ SOLO TYPE buttons

Tap these buttons to set the solo function type.

| Option | Meaning |
|---------------|---|
| PFL (default) | Pre-fader signals are used for solo monitoring. |
| AFL | Signals after panning (post-fader for the MAIN L/R Master module) are used for solo monitoring. |

The selected button will be highlighted.

⑨ DIM LEVEL knob

This adjusts the amount of monitoring signal attenuation when the DIM function is on.

Range: -40 dB – 0 dB (default: -20 dB)

Turn LCD knob 3 (lit red) to adjust it.

⑩ DELAY TIME

This adjusts the delay time used to correct the timing of monitoring signals, for example.

The highlighted unit will be used for operation, so tap the button for the desired unit.

| Unit options | Range |
|----------------|-------------------|
| meter | 0 – 117.3 (meter) |
| feet | 0 – 384.8 (feet) |
| msec (default) | 0 – 341.32 (msec) |

Turn LCD knob 4 (lit green) to adjust it.

⑪ SOLO LEVEL knob

Use this to adjust the output level from the SOLO L/R bus.

Range: -∞ dB – +10 dB (default: 0 dB)

Turn LCD knob 7 (lit red) to adjust it.

⑫ SOLO CLEAR button

- This button will appear highlighted when soloing is on for any of the modules.
- When this button is highlighted, tap it to end soloing on all channels.

NOTE

This has the same function as the SOLO CLEAR key on the top panel.

4 – Mixer configuration and settings

MONITOR SOURCE ASSIGN screen

On this screen, assign monitoring sources for monitoring from the front panel headphone jacks and the rear panel MONITOR OUT L/R jacks to the 6 MONITOR SELECT buttons.

To open this screen, tap the  icon in the MONITOR SELECT area on the left side of the MONITOR/SOLO page of the MONITOR SETUP screen.



① MONITOR SELECT page switches

Monitoring sources can be assigned on each MONITOR SELECT page separately.

The names of the assigned monitoring sources are shown on the MONITOR SELECT page.

Tap this area to switch open MONITOR SELECT pages.

② Monitoring source group page switches

These show monitor source group page names.

Tap a page name to switch to the page with the corresponding monitoring sources.

The name of the selected page will be highlighted.

| Page name | Contents |
|--------------|---|
| MIX MAIN L/R | Select output signals from MIX 1–22 and MAIN L/R Master modules. |
| ST IN PLAYER | Select input signals from the two pairs of ST IN jacks and the internal player. |
| Dante | Select input signals from the Dante connectors. |
| SLOT 1 | Select the inputs of the expansion card installed in SLOT 1. |
| SLOT 2 | Select the inputs of the expansion card installed in SLOT 2. |
| USB IN | Select USB audio interface inputs. |

③ Monitoring source assignment buttons

- Tap these buttons to select monitor sources to assign to the selected MONITOR SELECT button. Assigned buttons will be highlighted light blue. Assigned buttons for Dante ports that have virtually-mounted SB-16Ds will be highlighted yellow.
- Buttons for Dante ports that have mounted SB-16Ds assigned will be shown as “SB #[ID] [port number]”. If it is a virtually-mounted SB-16D,  will appear to the top right.

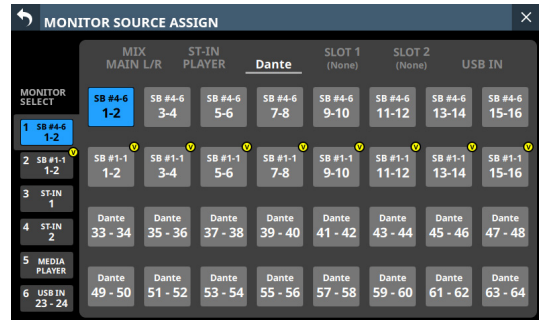

4 – Mixer configuration and settings

Making talkback and built-in oscillator settings

Make settings for talkback and the built-in oscillator on the MONITOR SETUP screen TALKBACK/OSCILLATOR page.

Tap Menu Screen > Mixer Setup > Talkback/OSC Setup to open this screen.

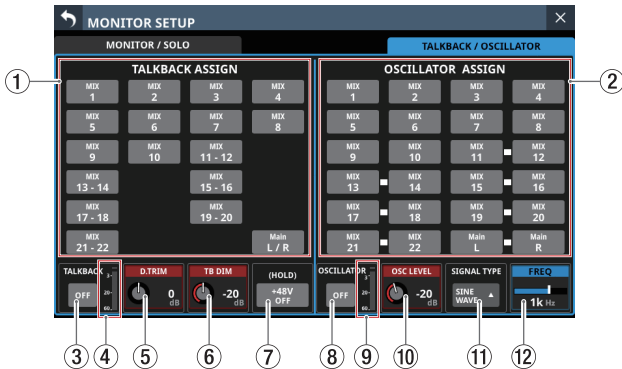

NOTE

- This screen can also be opened by pressing the TALKBACK key while pressing the MENU key. (See “13 – List of shortcut operations” on page 244.)
- Using the User Defined Control function, this screen can also be opened with a USER KEY, footswitch or the GPIO-IN. (See “USER DEFINED CONTROLS screen” on page 44.)
- Each level meter has an overload indicator at its top.

① TALKBACK ASSIGN

Tap these buttons to set the outputs for the talkback signal. (These are off by default.)
Buttons for selected outputs will be highlighted.

NOTE

Stereo buses have a single button for each pair.

② OSCILLATOR ASSIGN

Tap these buttons to set the outputs for the built-in oscillator signal. (These are off by default.)
Buttons for selected outputs will be highlighted.

NOTE

Outputs can be turned on/off independently even for stereo buses.

③ TALKBACK button

Tap this button to turn the TALKBACK function ON and OFF (default).
When this is ON, the button will appear highlighted.

NOTE

- This has the same function as the TALKBACK key on the top panel.
- Tap this button to switch it ON and OFF. Touch this button continuously to turn the function on only while being touched.
- Using the User Defined Control function, TALKBACK ON/OFF switching is also possible with a USER KEY, the footswitch or the GPIO-IN. (See “USER DEFINED CONTROLS screen” on page 44.)

This function is assigned to the following GPIO-IN on the GPIO-IN page by default.

- GPIO-IN 6 (Talkback ON/OFF)

④ TALKBACK level meter

This shows the TALKBACK signal input level.

⑤ D.TRIM knob

Use this to adjust the TALKBACK signal digital trim value.

Range: -20 dB – +20 dB (default: 0 dB)

Turn LCD knob 2 (lit red) to adjust it.

NOTE

Use the TALKBACK volume knob on the top panel to adjust the TALKBACK input level. (See “②⑥ TALKBACK volume” on page 12.)

⑥ TB DIM knob

When talkback is on, this adjusts the amount that the bus being used is attenuated.

Range: -40 dB – 0 dB (default: -20 dB)

Turn LCD knob 3 (lit red) to adjust it.

⑦ +48V button

Use this button to supply +48V phantom power to the TALKBACK jack on the rear panel.

Touch and hold the +48V button to turn phantom power (+48V) ON and OFF (default).

When this is ON, the button will appear highlighted.

⑧ OSCILLATOR button

Tap this button to turn the built-in oscillator signal ON and OFF (default).

When this is ON, the button will appear highlighted.

⑨ OSCILLATOR level meter

This shows the output level of the built-in oscillator.

⑩ OSC LEVEL knob

Use this to adjust the output level of the built-in oscillator.

Range: -36 dB – 0 dB (default: -20 dB)

Turn LCD knob 6 (lit red) to adjust it.

⑪ SIGNAL TYPE button

• This shows the signal type of the built-in oscillator.

• Tap this button to open the type selection menu.

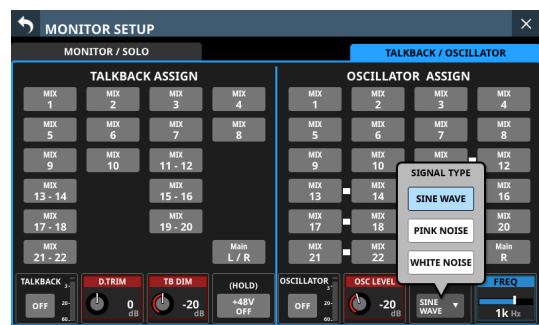

Options: SINE WAVE (default), PINK NOISE, WHITE NOISE

Tap an option button to close the menu, and show the selected signal type.

⑫ FREQ

This appears if the signal type is set to “SINE WAVE”.

Use this to adjust the output frequency of the built-in oscillator.

Options: 100 Hz, 440 Hz, 1 kHz (default), 10 kHz

Turn LCD knob 8 (lit blue) to adjust it.

4 – Mixer configuration and settings

Dante SETUP screen

On this screen, set and view the status of the built-in Dante module and an SB-16D connected via the built-in Dante module.

Tap Menu Screen > Rear Panel Setup > Dante Setup to open this page.

Dante Settings page

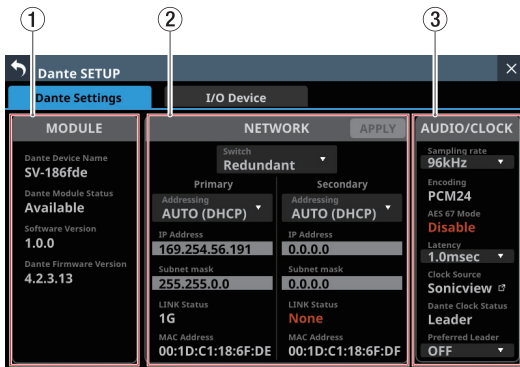

① MODULE status

This shows the status of the Dante module.

| Item | Content |
|------------------------|--|
| Dante Device Name | This shows the module name of the Dante device. |
| Dante Module Status | This shows the status of the Dante module. |
| Software Version | This shows the version of the built-in Dante module. This is the same as the Product Version shown in Dante Controller. |
| Dante Firmware Version | This shows the firmware version of the Dante system. This is the same as the Dante Firmware Version shown in Dante Controller. |

② NETWORK status

This shows the status of the Dante network.

When in Redundant mode, settings will be shown for the Primary connector on the left and for the Secondary connector on the right.

When in Switched (daisy-chain) mode, only the left side will be active.

| Item | Content |
|-------------|---|
| Switch | This shows the selected connection mode. Tap this area to open a window where Redundant or Switched mode can be selected. (default: Redundant) |
| Addressing | This shows the IP address setting mode. Tap this area to open a window where AUTO (DHCP) or STATIC can be selected. (default: AUTO (DHCP)) |
| IP Address | If the Addressing item is set to "AUTO", this will show the assigned IP address. If it is set to "STATIC", this will show the IP address set by the user. When the Addressing item is set to "STATIC", tapping this area will open the IP ADDRESS Screen. (See "IP Address/ Subnet Mask/Default Gateway setting procedures" on page 96.) |
| Subnet mask | If the Addressing item is set to "AUTO", this will show the assigned subnet mask. If it is set to "STATIC", this will show the subnet mask set by the user. When the Addressing item is set to "STATIC", tapping this area will open the SUBNET MASK Screen. (See "IP Address/ Subnet Mask/Default Gateway setting procedures" on page 96.) |
| LINK Status | This shows the Dante network link status. This will be shown in red if it is not 1 G. |
| MAC Address | This shows the MAC address of the Primary/Secondary Dante port. |

4 – Mixer configuration and settings

NOTE

To confirm Dante network settings, the Dante module must be restarted.

If Dante network settings have been changed, the APPLY button will appear highlighted.

Tap the APPLY button when it is highlighted to open a confirmation message.

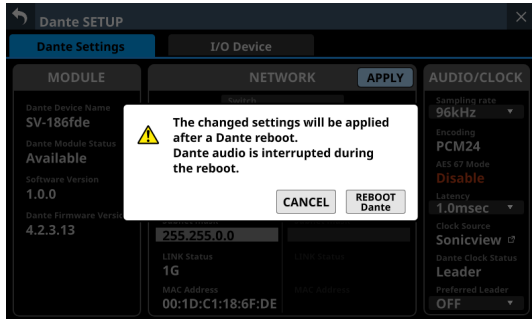

Tap the REBOOT Dante button to restart the Dante module.

ATTENTION

Be aware that Dante input and output sound will be interrupted while the Dante module is restarting.

③ **AUDIO/CLOCK setting status**

This shows the status of Dante audio signal and clock.

| Item | Content |
|--------------------|--|
| Sampling rate | This shows the sampling frequency setting of the built-in Dante module. Tap this area to open a window where 48kHz or 96kHz can be selected. (default: 96 kHz) NOTE If the sampling rate is 48kHz, 64 IN and 64 OUT will be available. If it is 96kHz, this becomes 32 IN and 32 OUT. |
| Encoding | This shows the encoding setting. |
| AES 67 Mode | This shows the AES67 mode. |
| Latency | This shows the latency setting. Tap this area to open a window where the latency (0.25msec, 0.5msec, 1.0msec, 2.0msec or 5.0msec) can be selected. (default: 1.0msec) |
| Clock Source | This shows the Dante module clock source (Dante or Sonicview). Tap the icon to open the SYNC CLOCK Screen. |
| Dante Clock Status | This shows the Dante clock status (Leader, Follower or Unlock). "Unlock" will be shown in red. |
| Preferred Leader | This shows the Preferred Leader setting. Tap this area to open a window where ON or OFF can be selected. (default: OFF) |

I/O Device page

Use this page to, for example, mount SB-16Ds, which are supported I/O devices, and make settings for them.

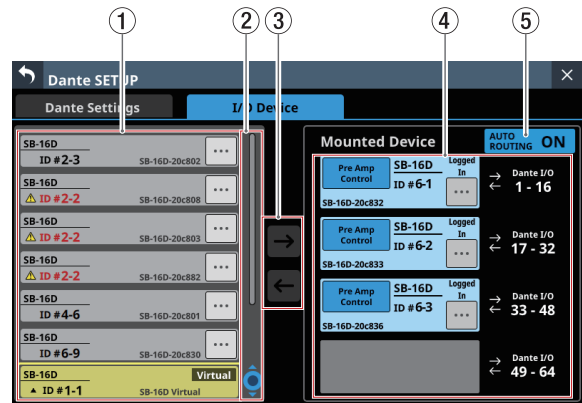

① **Device display area**

- This shows the ID numbers, model names (SB-16D) and Dante device module names for SB-16D units detected on the connected Dante network. SB-16D units that have different network addresses or are connected through routers will not be shown here.
- Selected devices will be highlighted with yellow frames.
- Tap the button to open the SB-16D control screen. (See "Control screen operations" on page 76.)

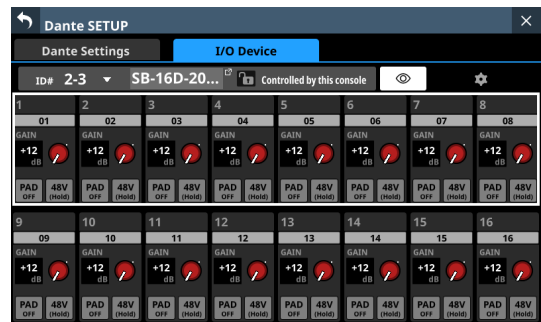

② **Scroll knob and scrollbar**

- If all the detected Dante devices cannot be shown on the screen at once, the scrollbar will appear and the scroll knob will be highlighted.
- Drag the scrollbar to scroll the screen. The device display area (①) can also be scrolled by swiping up and down as well as by turning LCD knob 4.

③ **Mount/unmount buttons**

Use these buttons to mount SB-16D units and to unmount already mounted ones.

See the following for operation procedures.

- "Mounting of devices connected to the Dante network" on page 67
- "Unmounting devices" on page 68
- "Mounting devices that are not on the Dante network" on page 69

4 – Mixer configuration and settings

④ Mounted Device area

This shows mounted devices.

The devices are shown with the following colors depending on status.

| Item | Status |
|------|---|
| | Device connected to the Dante network |
| | Virtual device that does not exist on the Dante network |

Selected devices and mounting positions will be highlighted with yellow frames.

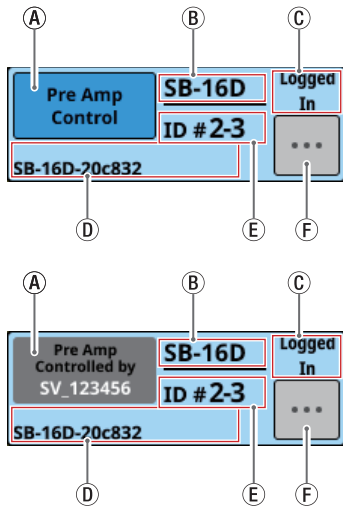

Ⓐ Control privilege display area: This shows the control privilege status.

| Item | Explanation |
|------|---|
| | This Sonicview has control privileges. |
| | This Sonicview does not have control privileges. The named Sonicview has control privileges. Tap this to open a message confirming whether or not to request control. (See "Setting control privileges after mounting" on page 69.) |
| | Control is possible from any device. Tap this to open a message confirming whether or not to request control. (See "Setting control privileges after mounting" on page 69.) |
| | This Sonicview does not have control privileges, so operation is not possible from the Home Screen or Module Screen. Tap this to open a message confirming whether or not to request control. (See "Setting control privileges after mounting" on page 69.) |
| | Mounting is in process. |

- Ⓑ This shows the module name. If no device with the same ID is connected to the same Dante network (when virtually-mounted), "Virtual" will be shown.
- Ⓒ This shows the login status.

| Item | Explanation |
|------------|---|
| Logged In | Information for this SB-16D can be acquired by this Sonicview. |
| Logged Out | Information for this SB-16D cannot be acquired by this Sonicview. (Login is not possible because this SB-16D is already mounted by 10 Sonicview units or a communication error occurred.) (See "Login failure" on page 72.) |

- Ⓓ This shows the module name of the Dante device set in this SB-16D.
- Ⓔ This shows the ID. If multiple devices with the same ID are connected to the same Dante network (when the same ID is duplicated), "ID" will be shown in red with a ⚠ mark.
- Ⓕ Tap this button to open the SB-16D control screen. (See "Control screen operations" on page 76.)

⑤ AUTO ROUTING button

This sets whether Dante routing settings are automatically made according to the SB-16D mounting state or using Dante Controller.

Tap this button to turn it on/off.

| Option | Meaning |
|--------------|--|
| ON (default) | SB-16D and Sonicview Dante routing is set automatically according to the SB-16D mounting status. We recommend this when an SB-16D is the only Dante device connected to the Sonicview. |
| OFF | Dante routing will not be set even if an SB-16D is mounted. Use Dante Controller for routing. Use this setting when connecting Dante devices other than an SB-16D. |

- When the AUTO ROUTING button is changed from "OFF" to "ON", the following confirmation message will appear if executing automatic Dante routing changes the Dante input routing of this unit.

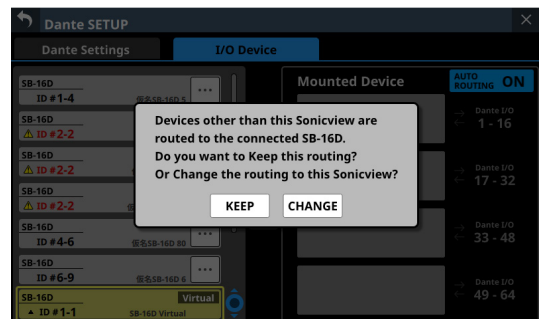

Tapping the KEEP button will switch the AUTO ROUTING button to "ON" but Dante routing settings will be retained as is. If an SB-16D is mounted after the AUTO ROUTING button is switched to "ON", routing will occur automatically.

4 – Mixer configuration and settings

Tapping the CHANGE button will change the Dante routing according to the mounting status. In this case, output routing from the Sonicview to other Dante devices will be retained as is, and output routing from the Sonicview to mounted SB-16D unit will be added.

- Example of Dante routing when the AUTO ROUTING button is OFF

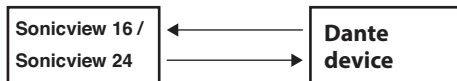

Mounted SB-16D

- Dante routing state after the AUTO ROUTING button is switched to "ON" from the above state and the CHANGE button is tapped

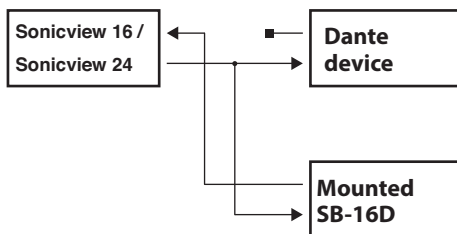

Using SB-16D units

To use SB-16Ds as a Sonicview I/O boxes, they must be mounted (registered) in advance.

See the following for operation procedures.

- "Mounting of devices connected to the Dante network" on page 67
- "Mounting devices that are not on the Dante network" on page 69
- A maximum of 4 SB-16D units can be mounted on a Sonicview.
- If an SB-16D is mounted and control privileges acquired, this unit will be able to do the following.
 - Control SB-16D preamps
 - Control SB-16D preamps using snapshot recall
 - Control/use GPIO ports (expansion mode)
 - Control Dante output routing
- The Sonicview manages SB-16D mounting status by ID. If no device with the same ID as the mounted ID is connected to the Dante network, "Virtual" will be shown instead of the device name.
- If multiple devices with the same ID are connected to the same Dante network (when the same ID is duplicated), "ID" will be shown in red with ⚠ marks for those devices.
- If the ID of a mounted device is used by more than one device, the SB-16D that was recognized by the Sonicview first will be used. However, duplicate IDs must be resolved to show them on the SB-16D control screen. (See "Resolving duplicate IDs" on page 70.)

Moreover, an SB-16D with a duplicate ID that is later recognized by the Sonicview cannot be used.
- If the AUTO ROUTING button on the IO Device page is "ON", the mounted SB-16D I/O ports and the main unit's built-in Dante I/O will be assigned to Dante routing automatically when mounted according to the mounting position in the Mounted Device area (④). See the table in "Dante routing" on page 73 for details.

4 – Mixer configuration and settings

Mounting of devices connected to the Dante network

1. Tap a device in the left column on the Dante network that you want to mount.

The selected device will be shown with a yellow frame.

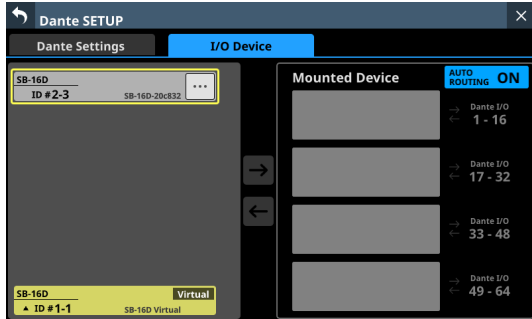

2. Tap the mounting destination on the right side (open mounting slot).
The selected mount destination will be shown with a yellow frame, and the central button will become highlighted.
3. Tap the central button to mount it in the selected destination on the right side.

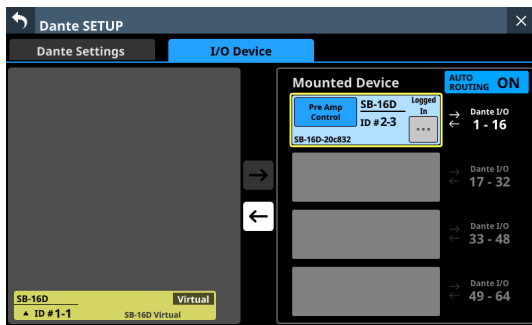

When mounting completes, a message will appear and information about control privileges after mounting will be shown in the top left of the mounting slot.

| Item | Explanation |
|----------------------------------|---|
| Pre Amp Control | Control is possible from this Sonicview. |
| Pre Amp Control by [device name] | The named Sonicview has control privileges. Control is not possible from this Sonicview. (Sound will pass.) |

NOTE

If control privileges are not held, control of the preamps, GPIO (expansion mode), snapshot recall and output routing will not be possible from this Sonicview even when mounted. If control privileges are acquired, control of the above items becomes possible, and sampling rate and reference level settings will be prioritized over those from other Sonicview units.

- If the Sonicview with control privileges is not on the Dante network:

After the mounting indicator disappears, a mounting completed message will be shown. This message will disappear automatically after a few seconds.

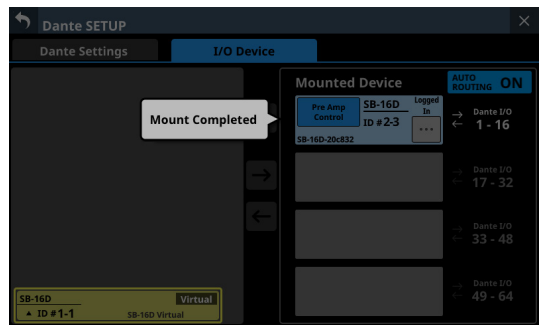
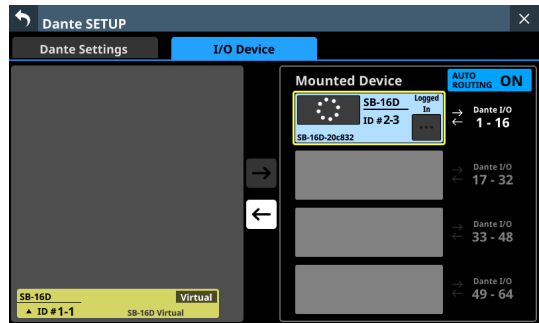

- If the Sonicview with control privileges is on the Dante network:

After mounting completes, tap the “Pre Amp Control by ..” button. When the following message appears, tap the REQUEST button, and wait for approval from the Sonicview that has control privileges.

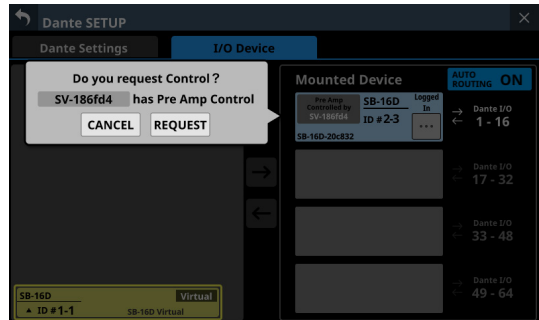

The following message will appear while waiting for permission. Tapping the CANCEL button will stop the permission waiting state and end the mounting operation.

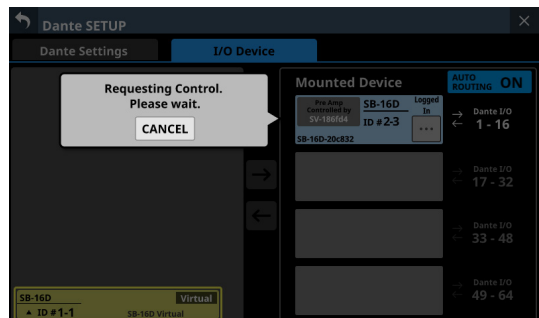

4 – Mixer configuration and settings

A permission request message will appear on the Sonicview with control privileges.



- This message will disappear automatically if the CANCEL button is tapped on the requesting device before the response is given on the Sonicview with control privileges.
- If a button in the permission request message on the Sonicview with control privileges is tapped, the following will appear on the requesting Sonicview.
 - Tapping the ALLOW button will cause a message confirming that control has been acquired to appear on the requesting device. This message will disappear automatically after 2 seconds.

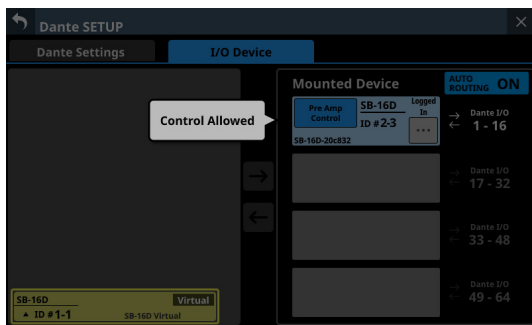

- Tapping the DENY button will open a message confirming refusal of the request. Tap the OK button to close the message.



Unmounting devices

1. Tap the device that you want to unmount in the right column list.

The selected device will be shown with a yellow frame, and the central button will become highlighted (←).

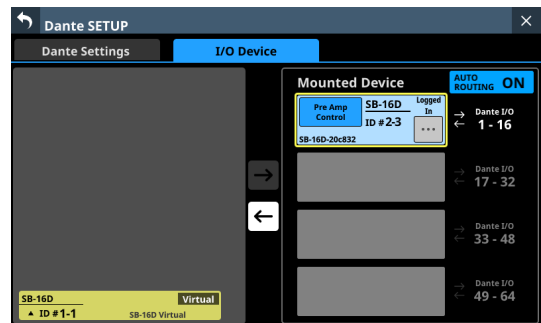

2. Tap the central button.

This unmounts the selected device, moving it to the list on the left.

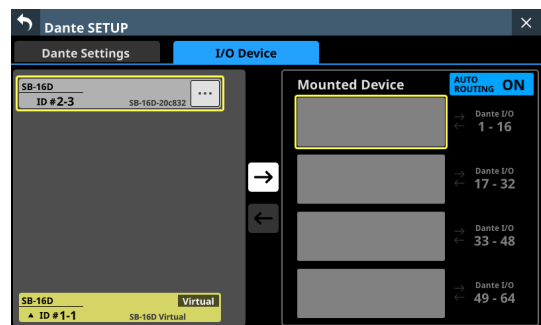

If control privileges were held before unmounting, they will be cleared.

“Open Control” will be shown in the control privilege display area on other Sonicview units that have this device mounted.

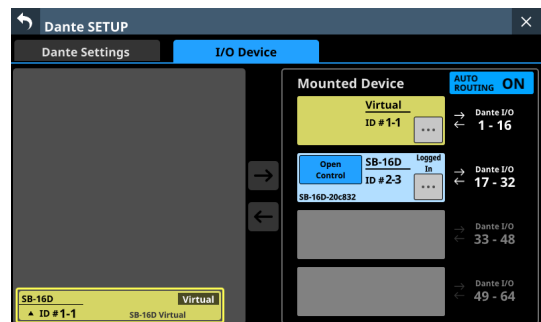

4 – Mixer configuration and settings

Mounting devices that are not on the Dante network

Devices that are not connected to the Dante network can be mounted virtually.

Connecting a device with a corresponding ID when the I/O Device page AUTO ROUTING button is "ON" will cause preamp and routing data to be applied.

1. Tap the ID at the very bottom of the list on the left to open a window where an ID number can be set for a virtually-mounted device.

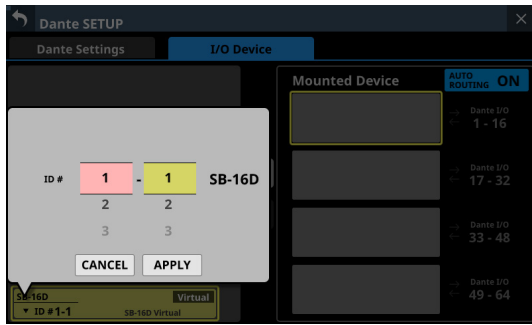

2. Swipe the options up and down to select the ID to mount. Selections can also be changed by turning the LCD Knobs 2 and 3, which are lit pink and yellow. If an ID that is already being used on the Dante network is selected, that ID will be red and the APPLY button will appear gray, showing the setting cannot be made.
3. Tap the APPLY button to confirm setting changes. The selected ID number will be shown.

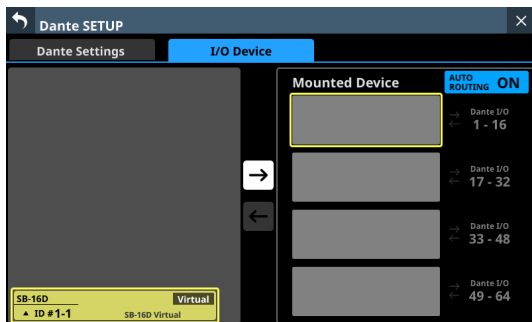

4. Tap the mounting destination on the right side (open mounting slot). The selected mount destination will be shown with a yellow frame, and the central button will become highlighted (□).
5. Tap the central button to mount it in the selected position on the right side.

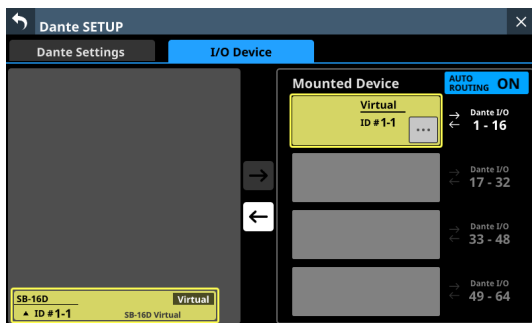

Setting control privileges after mounting

Control privileges can be requested after mounting.

1. Tap the control privilege display area for a mounted SB-16D with control privileges that have not been acquired to open a message.

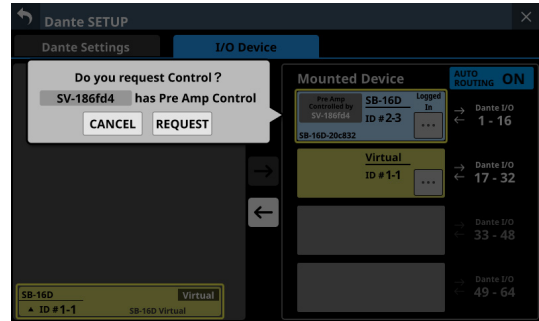

2. Tap the REQUEST button to start requesting control privileges. Tap the CANCEL button to cancel requesting control privileges.

NOTE

If control privileges are not acquired, control of the preamps, GPIO (expansion mode), snapshot recall and output routing for that SB-16D will not be possible from this Sonicview even when mounted.

If control privileges are acquired, control of the above items becomes possible, and sampling rate and reference level settings for that SB-16D will be prioritized over those from other Sonicview units.

4 – Mixer configuration and settings

Resolving duplicate IDs

- Resolving in the list on the right

1. Tap the button for a device with a duplicate ID to open the ID setting window.

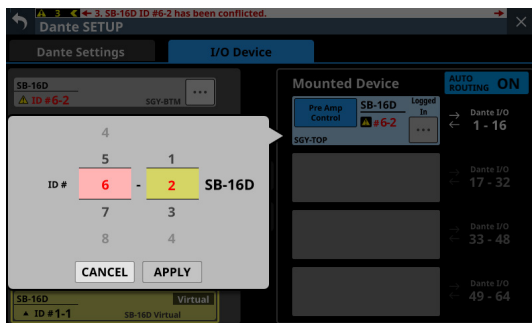

2. Swipe the options up and down to set the ID as desired. Selections can also be changed by turning the LCD Knobs 2 and 3, which are lit pink and yellow.

NOTE

If an ID that is already being used on the Dante network is selected, that ID will be red and the APPLY button will appear gray, showing the setting cannot be made.

3. Tap the APPLY button to confirm setting changes. The selected ID number will be shown.

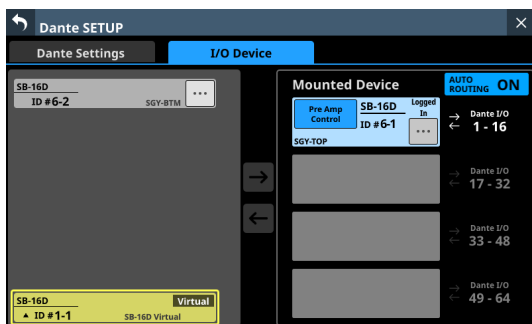

This resolves the duplication, and returns to the regular screen.

- Resolving in the list on the left

1. Tap the button for a device with a duplicate ID. This opens the control screen for the tapped device.

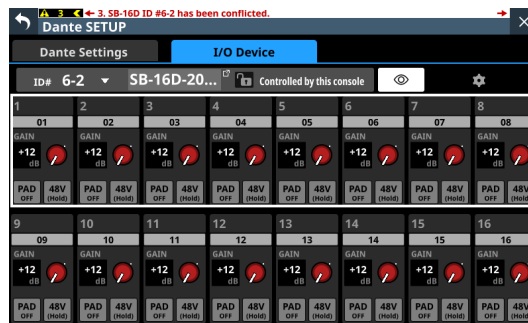

2. If "Controlled by this console" is shown to the right of the device name area, tap the ID area at the top left of the screen to open the ID setting window.

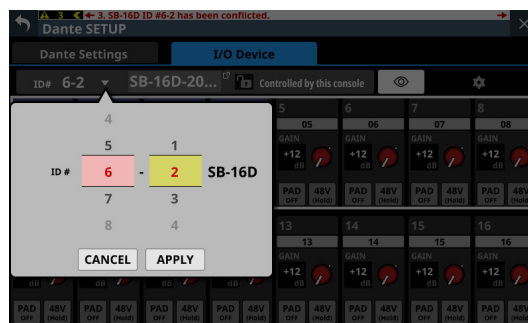

3. Swipe the options up and down to set the ID as desired. Selections can also be changed by turning the LCD Knobs 2 and 3, which are lit pink and yellow.

NOTE

If an ID that is already being used on the Dante network is selected, that ID will be red and the APPLY button will appear gray, showing the setting cannot be made.

4. Tap the APPLY button to confirm setting changes. The selected ID number will be shown.

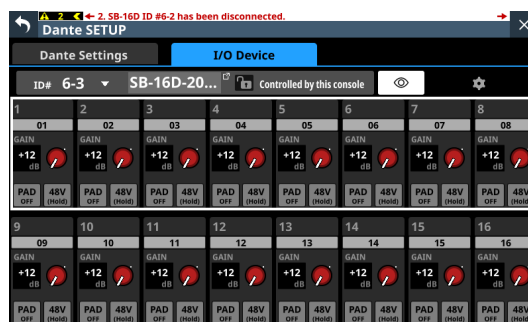

This resolves the duplication, and returns to the regular screen.

4 – Mixer configuration and settings

Alerts and errors shown related to the SB-16D

- When switching from virtual mounting to actual mounting:
The following message window will appear on the right touchscreen.



Tap the CLOSE button to close the message.

Tap the Dante Setup button to open the Dante SETUP Screen I/O Device page on the right touchscreen. In addition, the following alert message will appear at the top of every touchscreen.

SB-16D ID #xx-xx connected.

Tap this alert message to open the Dante SETUP Screen I/O Device page.

To close the alert message shown at the top of the screen, tap the  button on the corresponding message on the ERROR page of the INFORMATION screen. (See "ERROR page" on page 193.)

- When switching from actual mounting to virtual mounting:
When a mounted SB-16D is disconnected from the Dante network and becomes virtually mounted, the following error message will appear at the top of every touchscreen.

SB-16D ID #xx-xx has been disconnected.

Tap this error message to open the Dante SETUP Screen I/O Device page.

This error message can be resolved in the following ways.

- If the SB-16D returns to the Dante network, the error will be resolved automatically and the error message at the top of the screen will disappear.
- Tapping the  button on the corresponding error message on the ERROR page of the INFORMATION screen will close the error message at the top of the screen.
- Unmounting the corresponding device using the I/O DEVICE page of the Dante Setup screen will resolve the error and close the error message at the top of the screen.

- When an ID is used more than once:

When another SB-16D that has the same ID as a mounted SB-16D is connected to the Dante network, resulting in duplicate IDs, the following error message will appear at the top of every touchscreen.

SB-16D ID #xx-xx has a ID conflict.

Tap this error message to open the Dante SETUP Screen I/O Device page.

In this case, the device that was mounted first is given priority, so it has no impact on operation as a mixer.

If an ID becomes duplicated when there is a remaining alert message that occurred when switching from virtual mounting to actual mounting, the error message will appear

after the alert message is removed.

This error message can be resolved in the following ways.

- Resolving the duplicate ID using the I/O DEVICE page of the Dante screen will close the error message at the top of the screen.
- If the device causing duplication is removed from the Dante network, normal mounting status will be restored and the error message at the top of the screen will be closed.
- When this error message is resolved, the following error resolution message will be added to the ERROR page of the INFORMATION screen.

SB-16D ID #xx-xx conflict has been resolved.

Restrictions when routing during 96kHz operation with Dante Controller

- When the AUTO ROUTING button is set to "OFF", "Sonicview Dante I/O" and "ㄣ 1-16", for example, will not be shown in the list on the right of the I/O Device page.

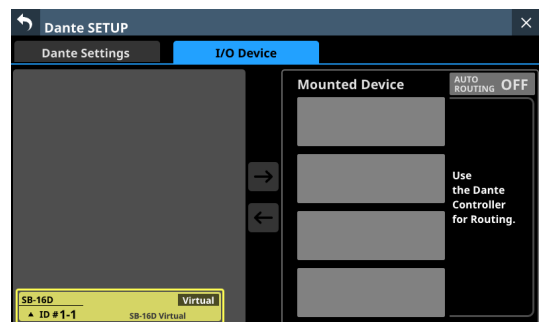

Instead, the message below will appear.

Use the Dante Controller for Routing.

- If the Sampling rate is set to "96kHz" on the Dante Settings page of the Dante SETUP screen, the list on the right of the I/O Device page will not show "ㄣ 33-48" and "ㄣ 49-64" in the bottom two mounting slots.
Alternatively, the message shown below will appear.

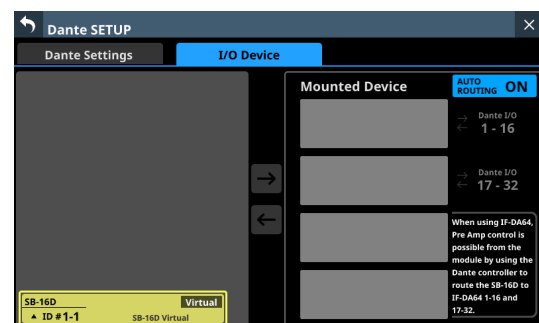

In this case, operations to acquire control privileges are necessary after mounting.

They will not be acquired automatically when mounted. Immediately after mounting, "Pre Amp Control OFF" will be shown in the control privilege display area.

- If no IF-DA64 (Dante card) is installed:
Tapping the control privilege display area will open the following message.

4 – Mixer configuration and settings

IF-DA64 is required to enable Pre Amp Control.
[CANCEL]

Tap the CANCEL button to close the message window and return to the previous screen. In this case, preamp control is not possible from this unit.

- If an IF-DA64 (Dante card) is installed:
Tapping the control privilege display area will open the following message.

Route as follows by Dante Controller.
[SB-16D 1-16ch] to [IF-DA64 (Slot1) 1-16ch]*
Do you want to enable Pre Amp Control?
[CANCEL] [ENABLE]

- Tap the CANCEL button to close the message window and return to the previous screen. In this case, preamp control is not possible from this unit.
- Tapping the ENABLE button will set the control privilege and “Pre Amp Control” will be shown in the control privilege display area.
- If another Sonicview, for example, already has SB-16D control privileges:
Tapping the control privilege display area will open the following message.

Route as follows by Dante Controller.
[SB-16D 1-16ch] to [IF-DA64 (Slot1) 1-16ch]*
Do you request control?
Sonicview XXX has Pre Amp control.
[CANCEL] [REQUEST]

After this, control privileges can be acquired by following the procedures from step 5 in “Mounting of devices connected to the Dante network” on page 67.

By acquiring control privileges with the above methods, preamp control becomes possible from the assigned module of the SLOT that the IF-DA64 (Dante card) is installed in as an input source.

- * This appears when an SB-16D is mounted in the 3rd mounting slot and an IF-DA64 (Dante card) is installed in SLOT 1.
If an SB-16D is mounted in the 4th mounting slot and an IF-DA64 (Dante card) is installed only in SLOT 2, the following message will appear.

Route as follows by Dante Controller.
[SB-16D 1-16ch] to [IF-DA64 (Slot2) 17-32ch]

Login failure

One SB-16D can be accessed simultaneously from a maximum of 10 Sonicview units.

If 10 units would be exceeded, the Sonicview that tries to access that SB-16D will fail (login failure) and will not be able to control that SB-16D.

“Logged Out” will be shown at the top right of mounted devices for which logging in failed.

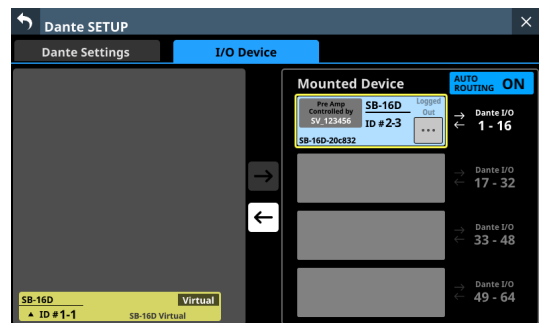

Tap the  button for unmounted or mounted devices to show the following messages that explain generally why login failed. Tap the OK button in the message to close it.

The content of the message depends on the reason login failed.

- If 10 units are already logged in

Login failed. Exceeded maximum number of connections.

- If login was not possible because of a communication error

Login failed. TCP Error.

If logging in fails when an SB-16D is mounted, mounting will be executed, but the above messages will be shown.

The following items are possible or not possible using mounted devices with which login failed.

- Possible
 - Input Dante Routing from the SB-16D to the Sonicview can be set with this unit, and the input sound of this SB-16D can be input to this unit.
 - Setting routing with Dante Controller makes inputting and outputting sound from this SB-16D possible.
- Not possible
 - Output Dante routing from the Sonicview to the SB-16D cannot be set with this unit. For this reason, sound from this unit cannot be output from this SB-16D.
 - Acquiring control privileges and changing/confirming preamp and other settings are not possible.

Responding to login failure errors

- If any Sonicview units are showing the operation screen for that unmounted SB-16D, close that screen.
- If that SB-16D is mounted on more than 10 Sonicview units, unmount it from a Sonicview unit that does not need it.
- If already mounted and logging in failed, after doing the above, unmount it and then mount it again.
- If the above responses do not resolve the issue, turn the SB-16D power off once and wait a few seconds before turning the power on again.

4 – Mixer configuration and settings

Synchronizing audio settings

If the Sonicview has control privileges after mounting, the SB-16D sampling rate and reference level (both analog and digital) settings will automatically be synchronized with those of that Sonicview. Moreover, it will also be set as the device for snapshot recall and set as the device with priority for Dante output routing.

Dante routing

Routing of Dante I/O for mounted SB-16Ds and the Sonicview can be done automatically.

On the other hand, routing can be left to Dante Controller and the Sonicview can be set to not do routing.

Use the AUTO ROUTING button on the I/O Device page to set this. (See “⑤ AUTO ROUTING button” on page 65.)

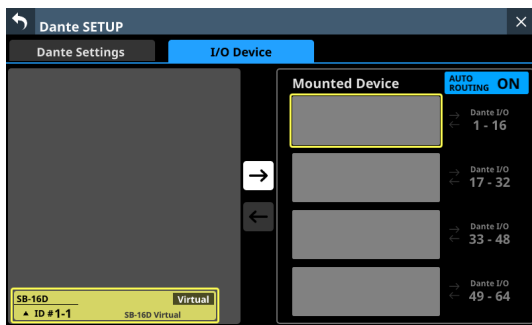

- To conduct Dante routing from the Sonicview for SB-16D units mounted on it, set the AUTO ROUTING button to “ON”. Dante routing will be set automatically when mounted. In this case, depending on the SB-16D mounting position, the mounted SB-16D I/O port and this unit’s built-in Dante I/O will be routed for Dante automatically when mounting occurs as shown below.

When Sync Clock is 48 kHz

| Mounting position in Mounted Device area | Routing destination |
|--|---------------------------------------|
| Top | Built-in Dante I/O 1–16 of this unit |
| 2nd from top | Built-in Dante I/O 17–32 of this unit |
| 3rd from top | Built-in Dante I/O 33–48 of this unit |
| 4th from top | Built-in Dante I/O 49–64 of this unit |

When Sync Clock is 96 kHz

| Mounting position in Mounted Device area | Routing destination |
|--|--|
| Top | Built-in Dante I/O 1–16 of this unit |
| 2nd from top | Built-in Dante I/O 17–32 of this unit |
| 3rd from top | This will not be routed automatically. Use Dante Controller to route Dante I/O 1–16 for the IF-DA64 installed in this unit and Dante I/O 1–16 for the mounted SB-16D. |
| 4th from top | This will not be routed automatically. Use Dante Controller to route Dante I/O 17–32 for the IF-DA64 installed in this unit and Dante I/O 1–16 for the mounted SB-16D. |

NOTE

When the AUTO ROUTING button is changed from “OFF” to “ON”, if executing automatic Dante routing changes the Dante input routing of this unit, the following message will appear to confirm whether to match the routing with the mounting status.

Devices other than this Sonicview are routed to the mounted SB-16D.
Do you want to KEEP the routing? Or Change the routing to this Sonicview?
[KEEP] [CHANGE]

Tapping the KEEP button will switch the AUTO ROUTING button to “ON” but Dante routing settings will be retained as is. If an SB-16D is mounted after the AUTO ROUTING button is switched to “ON”, routing will occur automatically.

Tapping the CHANGE button will change the Dante routing according to the mounting status. In this case, output routing from the Sonicview to other Dante devices will be retained as is, and output routing from the Sonicview to mounted SB-16D unit will be added.

- Example of Dante routing when the AUTO ROUTING button is OFF

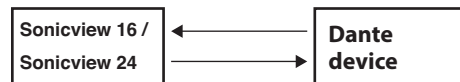

Mounted SB-16D

- Dante routing state after the AUTO ROUTING button is switched to “ON” from the above state and the CHANGE button is tapped

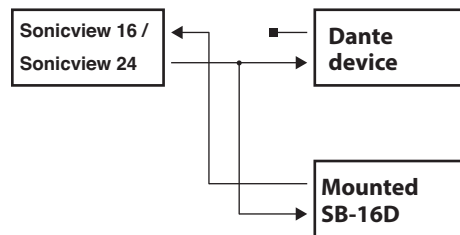

- To conduct Dante routing for the Sonicview from Dante Controller, set the AUTO ROUTING button to “OFF”. This will enable routing from Dante Controller.
 - When set to conduct Dante routing from Dante Controller, routing settings cannot be conducted from the Sonicview even for SB-16D units.

NOTE

Routing for mounted SB-16Ds will be retained as is. Routing will not occur automatically if an SB-16D is mounted after the AUTO ROUTING button is set to “OFF”.

4 – Mixer configuration and settings

SB-16D control

Preamp control as a Sonicview I/O expansion

From the operation screen of the module that has the built-in Dante input port routed, input connector preamps of SB-16Ds that have been routed by Dante to this Dante input port can be operated.

In this case, they can be operated in the same way as the built-in analog input preamps of the Sonicview.

Only if all the following conditions are all met, preamps can be operated on the Home Screen, MODULE (OVERVIEW) screen and Module (INPUT) screen.

- A Dante port is assigned to the module
- The SB-16D Dante port is routed to this Dante port
- The SB-16D that is routed to this Dante port is mounted on the Sonicview and control privileges are held, or it is virtually mounted

Example of appearance when mounted and control privileges are held

In this case the same preamp settings will be shown as would be when routing the built-in analog input jacks.

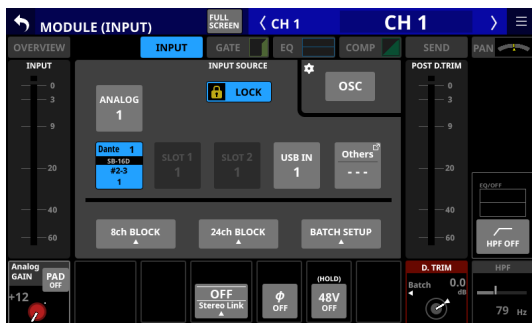
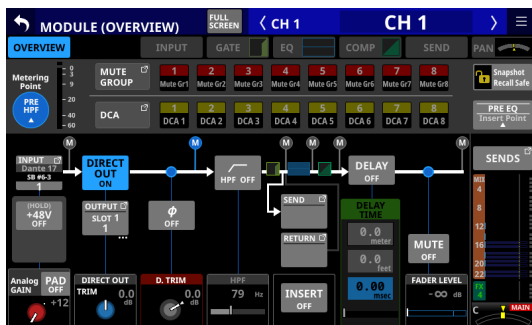

Example of appearance when mounted but control privileges are not held

In this case, the SB-16D preamp settings can be shown, but the GAIN knob, PAD buttons and 48V buttons will appear black and cannot be operated.

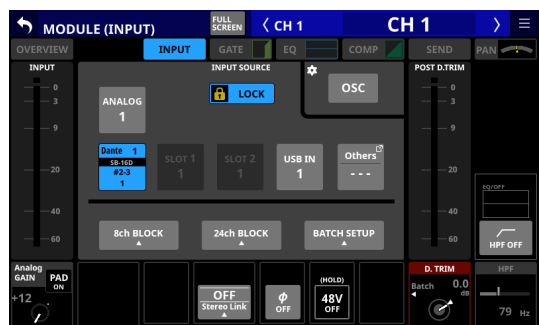
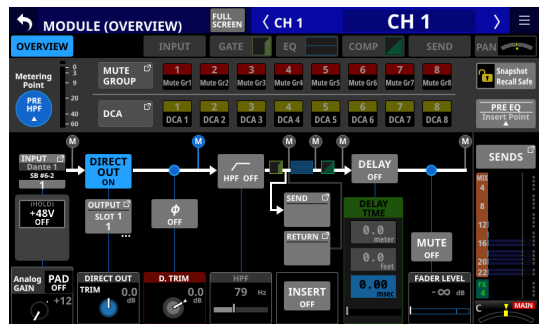
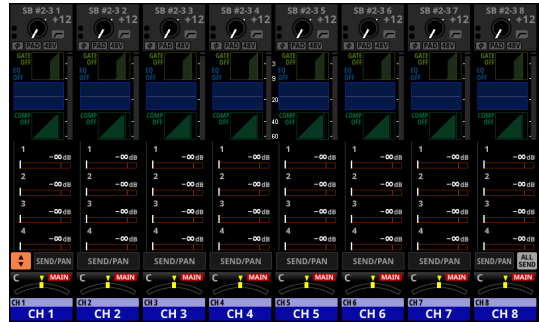

4 – Mixer configuration and settings

Example of appearance when virtually mounted

In this case the same preamp settings will be shown as would be when routing the built-in analog input jacks, and  marks are shown on routing settings.

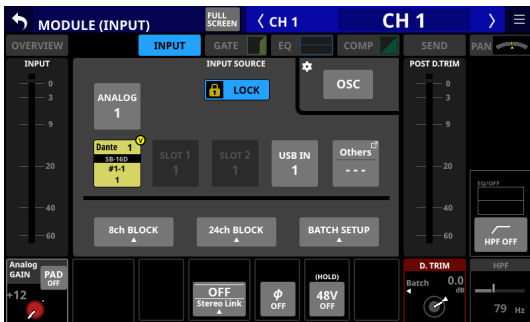
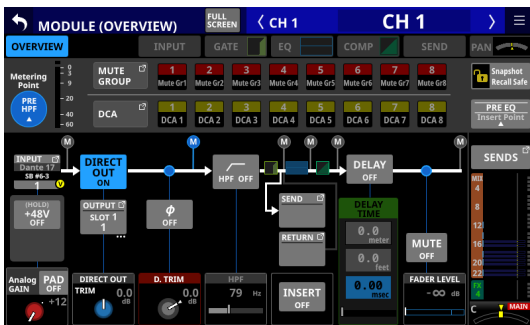

SB-16D full control

Whether they are mounted or not, SB-16D units that are connected to the same Dante network can be fully controlled from a Sonicview.

NOTE

If another Sonicview has SB-16D control privileges, its setting values can be shown, but they cannot be controlled. In this case, an  icon will appear at the top of the SB-16D control screen and the Dante device module name of the Sonicview that has control privileges will be shown.

1. Tap Menu Screen > Rear Panel Setup > Dante Setup to open the Dante SETUP screen and tap the I/O Device tab.

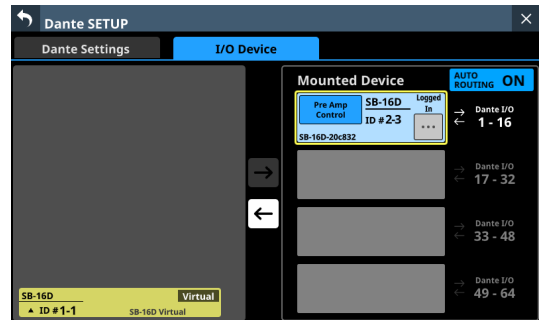

2. Tap the  button for the device you want to control. This opens the control screen.

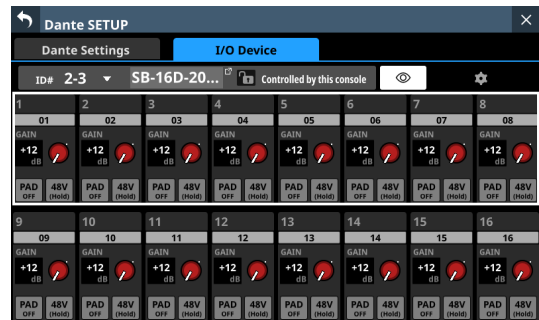

4 – Mixer configuration and settings

Control screen operations

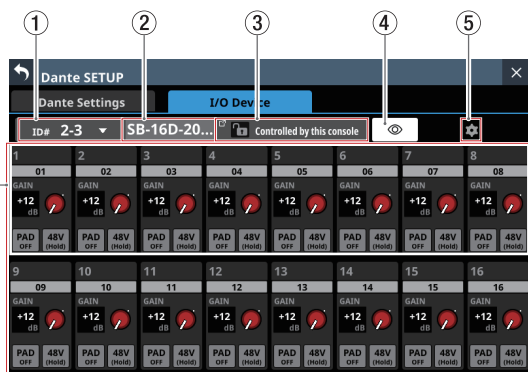

① ID

- This shows the current ID.
- Tap this area to open a window where the ID can be changed.

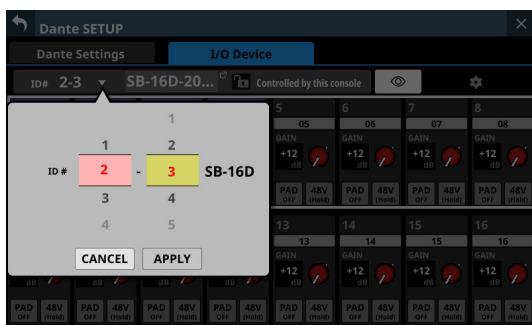

Swipe the options up and down to change the ID. Selections can also be changed by turning the LCD Knobs 2 and 3, which are lit pink and yellow.

- Tap the APPLY button to change the selected ID.
- Tap the CANCEL button to close the window without changing the ID.

NOTE

- If an ID that is already being used on the Dante network is selected, that ID will be red and the APPLY button will appear gray, showing the setting cannot be made.
- Changing the ID when mounted could cause it to become unmounted.

② Device name

- This shows the module name of the SB-16D Dante device.
- Tap this area to enable changing the module name of the Dante device.
- If the device is virtually mounted, “---” will appear and tapping will not enable changing.

③ Control privilege status

- This shows the control privilege status.
- If this unit has control privileges, and “Controlled by this console” will be shown.
- If this unit does not have control privileges, and “Controlled by [Dante device module name of the Sonicview that has control privileges]” will be shown.
- In the following cases, nothing will be shown.
 - If no device has control privileges for that SB-16D
 - If the device is virtually mounted

④ button

- Tap this button to send an Identify command to the SB-16D. The SB-16D that receives the Identify command will respond by blinking its SIG and STATUS indicators, making it possible to confirm the corresponding device. Tapping this button again when an SB-16D is responding will send it another Identify command, which will cause it to stop responding.

- This button is not shown for devices that are virtually mounted.

⑤ button

- Tap this button to open the Settings Screen where settings other than those related to preamp operation can be checked.

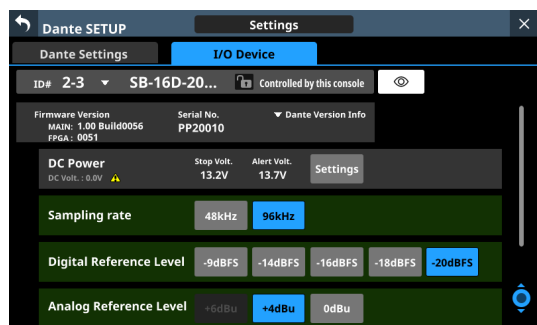

⑥ Channel modules

- Work with channel names, GAIN knobs, PAD buttons and 48V buttons in this area.
 - Tapping a channel name will open the RENAME screen where it can be edited.
 - GAIN levels of the channels selected by the frame can be adjusted using the 1–8 LCD knobs that are lit red.
 - Tap a PAD button to turn the -20dB pad on/off. When this button is on, it will appear highlighted.
 - Touch and hold the 48V button to turn phantom power (+48V) on/off. When phantom power is on, the button will be highlighted.
- GAIN knobs, PAD buttons and 48V buttons can also be used with virtually mounted devices.
- If another Sonicview has control privileges for the SB-16D shown, it will appear as follows and cannot be controlled.

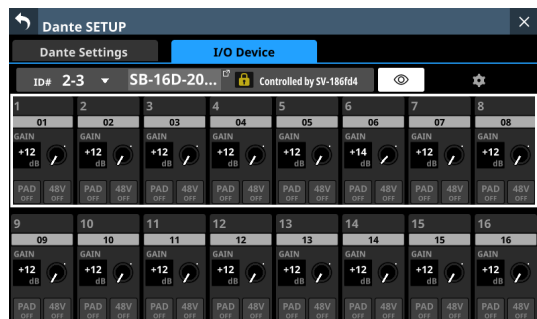

Example of appearance when control privileges are not held

4 – Mixer configuration and settings

Settings screen

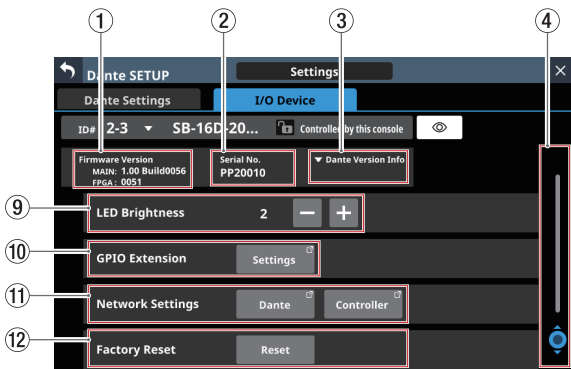
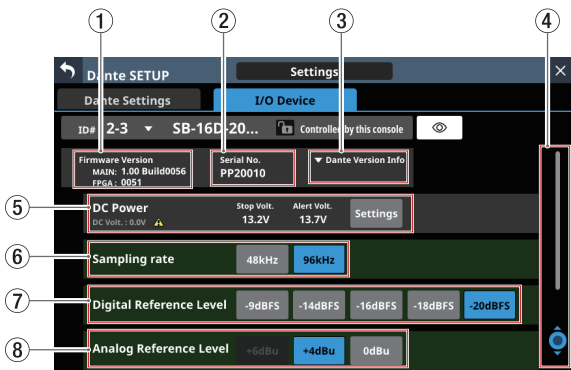

① Firmware Version

This shows the SB-16D firmware versions. If the device is virtually mounted, “---” will appear in place of the numbers.

② Serial No.

This shows the serial number of the SB-16D. “---” will appear if the device is virtually mounted.

③ Dante Version

- This shows the SB-16D Dante module firmware version. If the device is virtually mounted, nothing will be shown even if tapped.
- Tap this area to open a Dante information window.

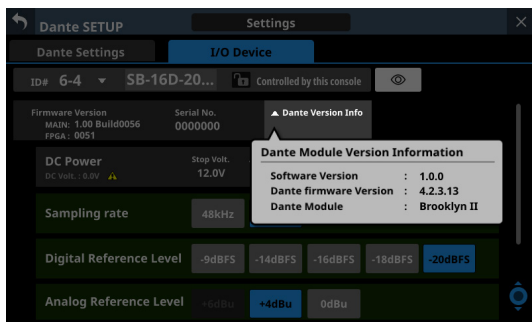

④ Scroll knob and scrollbar

This scroll bar shows the position of the setting items currently shown on the screen relative to all items on the Settings Screen.

NOTE

To view setting items not shown on the screen, swipe the setting items area up and down to scroll the screen. LCD knob 8, which is lit light blue, can also be turned to scroll the screen.

⑤ DC Power information

SB-16D DC power status is shown and related settings can be made here.

| Item | Explanation |
|-----------------|--|
| DC Volt. | This shows the current voltage and status of the DC power supply. A green indicator will be shown if the DC power supply is providing power normally. If the alert display setting is on, and the DC power supply voltage has become less than the alert voltage, an ⚠ indicator will be shown. No indicator will be shown if the DC power supply is not providing power (if the DC power supply voltage is below the stop voltage). |
| Stop Volt. | This shows the stop voltage setting value. |
| Alert Volt. | This shows the setting value for the voltage that triggers showing an alert. If the Alert Voltage ON/OFF button is set to “OFF” in the DC Power settings window, “--.V” will be shown here. |
| Settings button | Tap this button to open the DC Power settings window. (See “DC Power settings” on page 78.) |

“---” will appear for all the settings if the device is virtually mounted. In addition the Settings button will appear gray and cannot be used.

⑥ Sampling rate buttons

These set the sampling frequency for the SB-16D. The selected button will be highlighted.

⑦ Digital Reference Level buttons

Use these to set the digital reference level of the SB-16D. The selected button will be highlighted.

⑧ Analog Reference Level buttons

Use these to set the analog reference level of the SB-16D. The selected button will be highlighted.

NOTE

- The settings of Sampling rate (⑥), Digital Reference Level (⑦) and Analog Reference Level (⑧) buttons with green backgrounds are linked to the settings of the Sonicview that has control privileges. For this reason, settings cannot be changed on this Settings screen if mounted.
- For virtually mounted devices, Sampling rate (⑥), Digital Reference Level (⑦) and Analog Reference Level (⑧) button settings will all appear gray and cannot be operated.

4 – Mixer configuration and settings

⑨ LED Brightness buttons

- Use the and buttons to set the brightness of the SB-16D indicators.

Range: 0 – 3 (default 3)

- If the device is virtually mounted, “–” will appear and the buttons will be gray and cannot be operated.

⑩ GPIO Extension

Tap the Settings button to open the GPIO Extension Settings Screen. (See “GPIO Extension Settings Screen” on page 79.)

Virtually-mounted devices can also be operated.

⑪ Network Settings

- Tap the Dante button to open the Dante Network Settings on the Network Settings Screen. (See “Dante Network Settings” on page 81.)

- Tap the Controller button to open the Controller Network Settings on the Network Settings Screen. (See “Control Network Settings” on page 82.)

- If the device is virtually mounted, the Dante and Controller buttons will be gray and the settings screen cannot be opened.

⑫ Factory Reset button

Tap the Reset button to open a window where settings can be restored to their factory default values. (See “Factory Reset” on page 82.)

If the device is virtually mounted, this button will be gray and cannot be operated.

DC Power settings

Tap the Settings button in the DC Power area to open the following DC Power settings window.

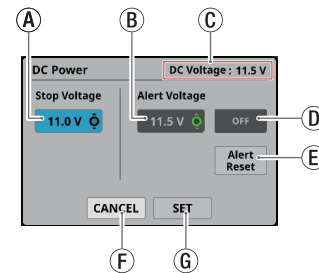

- ① Stop Voltage: This sets the stop voltage.

Use LCD knob 4, which is lit light blue, to adjust it.

Range: 11.0 – 27.0 V

(in steps of 0.1 V, default 11.0 V)

If the SB-16D is operating with only DC power supply, it will shut down if the DC power supply goes below this voltage.

If DC power is supplied from a battery, set the stop voltage according to the battery specifications. In all other cases, set this to a minimum of 11.0 V (the default value).

- ② Alert Voltage: This sets the alert voltage.

Use LCD knob 5, which is lit green, to adjust it.

Range: OFF, 11.0 – 28.0 V

(in steps of 0.1 V, default 11.5 V)

When the Stop Voltage setting is changed, this is automatically set +0.5V higher than the Stop Voltage. Change this setting to adjust the timing if the alert is shown too quickly or too late.

- ③ DC Voltage: This shows the current DC input voltage.

- ④ Alert Voltage ON/OFF button: Tap this button to turn the alert message on/off. (Default: ON)

When ON, if the DC power supply voltage becomes less than the alert voltage, the following alerts will be shown.

- SB-16D DC POWER indicator blinks
- indicator appears in DC Power area (⑤)

- ⑤ Alert Reset button: Tap this button to reset the Alert Voltage setting to the default value (Stop Voltage +0.5 V).

- ⑥ CANCEL button: Tap this button to discard the changes in the DC Power settings window and close it.

- ⑦ SET button: Tap this button to confirm the values in the DC Power settings window and close it.

4 – Mixer configuration and settings

GPIO Extension Settings Screen

The SB-16D GPIO port has the following functions.

GPIO-IN

- Muting control of SB-16D input and output signals (Local mode function)
- Mounted Sonicview extension GPIO-IN port operation (Extension mode function)

GPIO-OUT

- Tally output for muting states of SB-16D input and output signals (Local mode function)
- Mounted Sonicview extension GPIO-OUT port operation (Extension mode function)

The following settings to use these functions can be made on this screen.

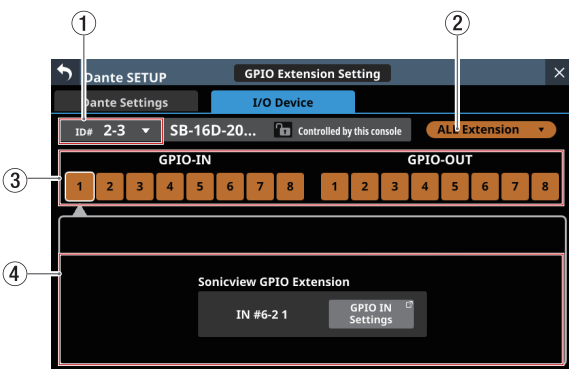

ALL Extension mode

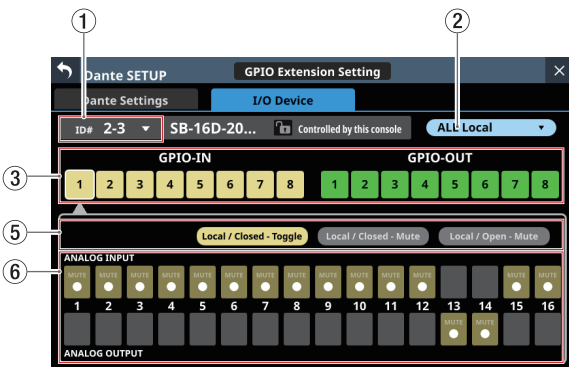

ALL Local mode

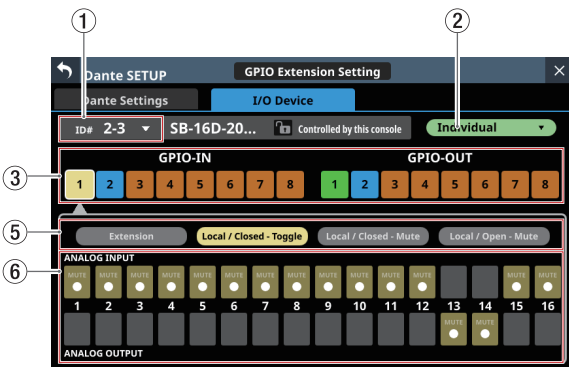

Individual mode

① ID

- This shows the current ID.
- Tap this area to open a window where the ID can be changed.

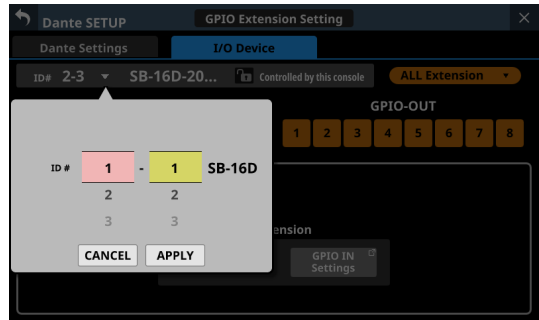

Swipe the options up and down to change the ID. Selections can also be changed by turning the LCD Knobs 2 and 3, which are lit pink and yellow.

- Tap the APPLY button to change the selected ID.
- Tap the CANCEL button to close the window without changing the ID.

NOTE

- If an ID that is already being used on the Dante network is selected, that ID will be red and the APPLY button will appear gray, showing the setting cannot be made.
- Changing the ID when mounted could cause it to become unmounted.

② GPIO port overall operation mode

- This shows the overall operation mode for the GPIO port.
- Tap this area to open a window where the overall operation mode for the GPIO ports of the SB-16D can be changed.

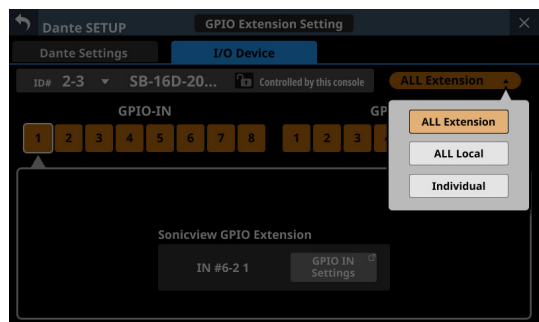

| Option | Explanation |
|---------------|---|
| ALL Extension | The ALL Extension mode setting uses all GPIO ports as GPIO extension pins of the Sonicview that the SB-16D is mounted in. |
| ALL Local | The ALL Local mode setting uses all GPIO ports as pins that do the following. <ul style="list-style-type: none"> • GPIO-IN: SB-16D input/output signal muting control • GPIO-OUT: Tally output for muting states of SB-16D input/output signals |
| Individual | In this mode, the operation of each GPIO port is set individually. |

Tap an option to switch the overall operation mode for the GPIO port of the SB-16D.

4 – Mixer configuration and settings

③ Pin number buttons

- Tap this area to select a pin and show its settings in the Sonicview GPIO Extension display area (④), the operation/action mode switching buttons for the individual pin (⑤) and the input/output signal selection status display area (⑥).
- When the overall operation mode for GPIO ports is “ALL Local” or “Individual”, tapping a pin number button will outline that button with a white frame.

④ Sonicview GPIO Extension display area

The GPIO IN Settings (when GPIO-IN pin selected) or GPIO OUT Settings (when GPIO-OUT pin selected) button is shown when the operation mode for the selected GPIO port is as follows.

- When the GPIO port overall operation mode (②) is “ALL Extension”
- When the GPIO port overall operation mode (②) is “Individual” and the operation/action mode button (⑤) is “Extension”

The selected GPIO port is used as a GPIO extension pin of the Sonicview that has the subject SB-16D mounted. Set this with the GPIO-IN and GPIO-OUT pages on the USER DEFINED CONTROLS Screen of the Sonicview that has the subject SB-16D mounted.

⑤ Operation/action mode switching buttons for individual ports

- These show the operation mode for the selected GPIO port in the following cases.
 - When GPIO port overall operation mode (②) is “ALL Local”
 - When the GPIO port overall operation mode (②) is “Individual”
- These show the operation and action modes of the selected GPIO Port.
- Tap these buttons to switch the operation and action modes of the individual port.

For GPIO IN ports

| Option | Explanation |
|-----------------------|--|
| Extension | The Extension mode setting uses the selected ports as GPIO extension pins of the Sonicview that the SB-16D is mounted in. This can only be selected when the GPIO port overall operation mode (②) is “Individual”. |
| Local / Closed-Toggle | In this mode, when the selected IN port becomes shorted (Closed), the SB-16D input/output signal selected in the input/output signal selection status area (⑥) is muted/unmuted (toggled). |
| Local / Closed-Mute | In this mode, when the selected IN port becomes shorted (Closed), the SB-16D input/output signal selected in the input/output signal selection status area (⑥) is muted. |
| Local / Open-Mute | In this mode, when the selected IN port becomes open (Open), the SB-16D input/output signal selected in the input/output signal selection status area (⑥) is muted. |

For GPIO OUT ports

| Option | Explanation |
|---------------------|--|
| Extension | The Extension mode setting uses the selected ports as GPIO extension pins of the Sonicview that the SB-16D is mounted in. This can only be selected when the GPIO port overall operation mode (②) is “Individual”. |
| Local / Mute-Closed | In this mode, when the SB-16D input/output signal selected in the input/output signal selection status area (⑥) is muted, the selected OUT port becomes shorted (Closed). |
| Local / Mute-Open | In this mode, when the SB-16D input/output signal selected in the input/output signal selection status area (⑥) is muted, the selected OUT port becomes open (Open). |

⑥ Input/output signal selection status

These show the operation mode for the selected GPIO port in the following cases.

- When GPIO port overall operation mode (②) is “ALL Local”
- When the GPIO port overall operation mode (②) is “Individual” and the individual port operation/action mode button (⑤) is “Local / xxxx”

When a GPIO-IN pin is selected, the SB-16D input/output signal that is subject to muting control is selected according to that pin. Up to 16 can be selected for muting control by GPIO-IN pin. If the selectable number is exceeded, the check fields will be shown in gray and become unselectable.

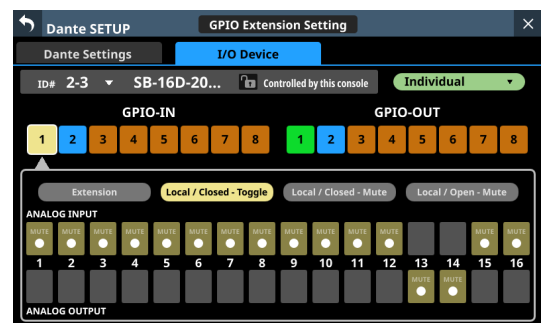

When a GPIO-OUT pin is selected, this selects the SB-16D input/output signal for mute status tally output from the selected pin. A maximum of 16 input/output signals of the SB-16D used for tally output can be selected. If the selectable number is exceeded, the check fields will be shown in gray and become unselectable. When multiple input/output signals are selected, tally output will occur if any of the selected input/output signals are muted.

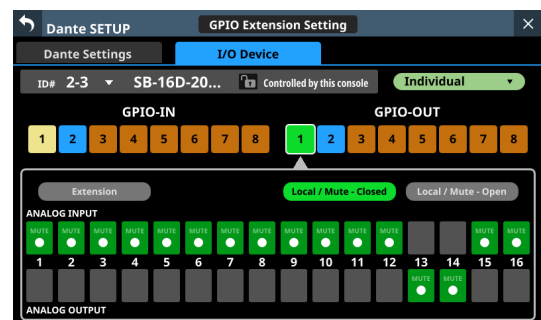

4 – Mixer configuration and settings

Dante Network Settings

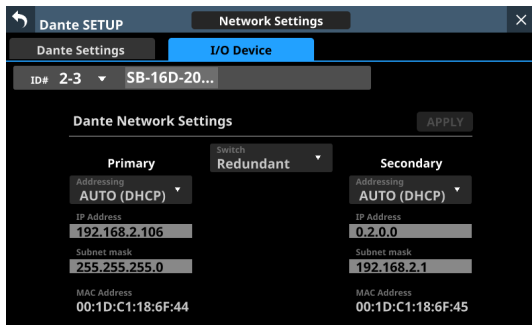

This shows the status of the Dante network settings for the SB-16D.

When in Redundant mode, settings will be shown for the Primary connector on the left and for the Secondary connector on the right.

When in Switched (daisy-chain) mode, only the left side will be active.

| Item | Content |
|-------------|---|
| Switch | This shows the selected connection mode. Tap this area to open a window where Redundant or Switched mode can be selected. (default: Redundant) |
| Addressing | This shows the IP address setting mode. Tap this area to open a window where AUTO (DHCP) or STATIC can be selected. (default: AUTO (DHCP)) |
| IP Address | If the Addressing item is set to "AUTO", this will show the assigned IP address. If it is set to "STATIC", this will show the IP address set by the user. When the Addressing item is set to "STATIC", tapping this area will open the IP ADDRESS Screen. (See "IP Address/Subnet Mask/Default Gateway setting procedures" on page 96.) |
| Subnet mask | If the Addressing item is set to "AUTO", this will show the assigned subnet mask. If it is set to "STATIC", this will show the subnet mask set by the user. When the Addressing item is set to "STATIC", tapping this area will open the SUBNET MASK Screen. (See "IP Address/Subnet Mask/Default Gateway setting procedures" on page 96.) |
| LINK Status | This shows the Dante network link status. This will be shown in red if it is not 1 G. |
| MAC Address | This shows the MAC address of the Primary/Secondary Dante port. |

To confirm Dante network settings for the SB-16D, the SB-16D Dante module must be restarted.

If SB-16D Dante network settings have been changed, the APPLY button will appear highlighted.

Tap the APPLY button when it is highlighted to open a confirmation message.

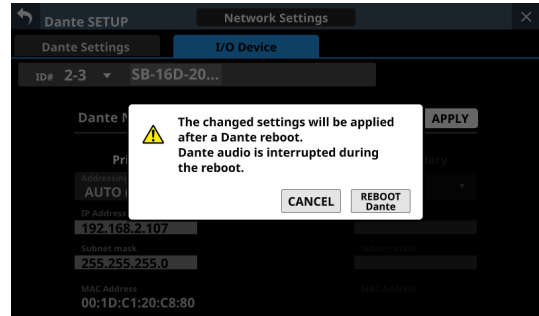

Since tapping the CANCEL button will not restart the unit, the settings will be as is but will not be applied to operation.

Tap the REBOOT Dante button to confirm the changes and restart the SB-16D Dante module.

After restarting, the settings will be applied to operation.

ATTENTION

Be aware that SB-16D Dante input and output sound will be interrupted while the SB-16D Dante module is restarting.

4 – Mixer configuration and settings

Control Network Settings

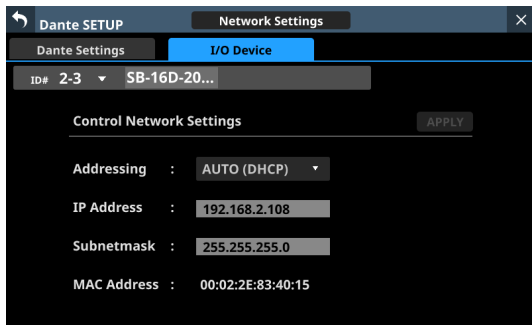

This shows the status of the Dante network settings for SB-16D control.

| Item | Content |
|-------------|--|
| Addressing | This shows the IP address setting mode. Tap this area to open a window where AUTO (DHCP) or STATIC can be selected. (default: AUTO (DHCP)) |
| IP Address | If the Addressing item is set to "AUTO", this will show the assigned IP address. If it is set to "STATIC", this will show the IP address set by the user. When the Addressing item is set to "STATIC", tapping this area will open the IP ADDRESS Screen. (See "IP Address/Subnet Mask/Default Gateway setting procedures" on page 96.) |
| Subnet mask | If the Addressing item is set to "AUTO", this will show the assigned subnet mask. If it is set to "STATIC", this will show the subnet mask set by the user. When the Addressing item is set to "STATIC", tapping this area will open the SUBNET MASK Screen. (See "IP Address/Subnet Mask/Default Gateway setting procedures" on page 96.) |
| MAC Address | This shows the MAC address for SB-16D control. |

If Dante network settings for SB-16D control have been changed, the APPLY button will appear highlighted. When settings are applied, the SB-16D Dante network connection will be interrupted once. For this reason, tap the APPLY button when it is highlighted to open a confirmation message.

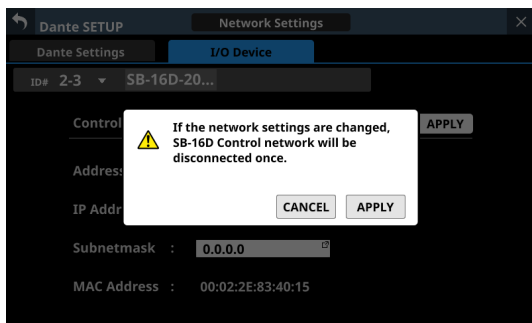

Tap the CANCEL button to cancel the changes and restore the previous state.

Tap the APPLY button to confirm the changes.

Factory Reset

1. Tap the Reset button to open a window where settings can be restored to their factory default values.

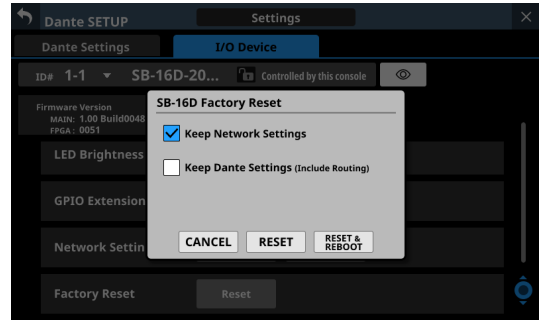

| Item | Explanation |
|---------------------------------------|--|
| Keep Network Settings | If the check mark (✓) is added, the SB-16D Dante network settings will be retained. If the check mark (✓) is removed, the SB-16D Dante network settings will be restored to their factory defaults. (This has a check (✓) by default.) |
| Keep Dante Settings (Include Routing) | If the check mark (✓) is added, the SB-16D Dante settings will be retained. If the check mark (✓) is removed, the SB-16D Dante settings will be restored to their factory defaults. (This does not have a check (✓) by default.) |

2. Add check marks (✓) for the settings that you want to retain. Remove check marks (✓) for the settings that you want to restore to factory defaults.

NOTE

If check marks (✓) are added to both, only settings that are not related to the Dante network and Dante will be restored to their factory defaults.

4 – Mixer configuration and settings

3. Tapping the RESET or RESET & REBOOT button will open the following warning messages in a window.

- Message if Keep Network Settings does not have a check mark (✓):

Network may be disconnected.

- Message if Keep Dante Settings (Include Routing) does not have a check mark (✓):

Audio will be interrupted.
Dante routing will be cleared.

- Message when the RESET & REBOOT button is tapped:

Audio will be interrupted.



Message if Keep Network Settings does not have a check mark (✓)

4. Tap the RESET button in the warning message to close the window and restore the following items to their factory default settings.
- Settings without check marks (✓)
 - Settings other than those for Dante network and Dante

ATTENTION

If the RESET & REBOOT button is tapped, after settings are restored to their factory defaults, the I/O Device page of the Dante Setup screen will open. Moreover, until the reset SB-16D has completed restarting it will be disconnected from the Dante network. Tap the CANCEL button to close the window without changing the settings.

Using GPIO extension functions

If the SB-16D GPIO pin operation mode is set to "Extension", they can be used as Sonicview GPIO extension pins.

This setting can also be made for virtually mounted SB-16D units.

By storing the settings in the Sonicview, online setting is possible.

Setting procedure

1. Following the instructions in "GPIO Extension Settings Screen" on page 79 for the "Overall operation mode for the GPIO port buttons" (②) or "Operation mode switching buttons for individual ports" (⑧), set the operation mode for the ports you want to use as a GPIO extension for this unit to "Extension".
2. Use the following procedures to open GPIO-IN and GPIO-OUT screens.
 - Tap Menu Screen > Rear Panel Setup > GPIO Input Setup
 - Tap Menu Screen > Rear Panel Setup > GPIO Output Setup

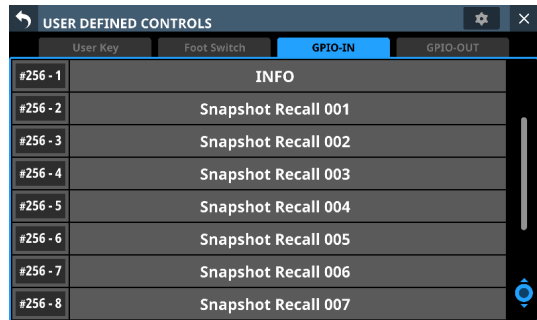

3. Use LCD knob 8 to scroll the list of settings for groups of 8 ports that correspond to mounting positions.
 - In the SB-16D GPIO pin name area, SB-16D IDs and port numbers are shown in a "#ID [port number]" format.
 - If the device is virtually mounted, the GPIO port name background will appear yellow.
 - Ports with operation mode set to Extension in the list will be highlighted.
 - Ports with operation mode set to Local in the list will be shown in gray.
4. Tap the port you want to set in the list and assign functions using the same procedures as with the unit's built-in GPIO.

4 – Mixer configuration and settings

Procedures for Dante connection with SB-16Ds

This explains procedures for connecting an SB-16D as a stage box to this unit, and controlling its preamps from modules with built-in Dante ports assigned in the same way as built-in analog inputs.

Dante connections with SB-16Ds

- When this unit is operating at 48 kHz, up to 4 SB-16D units can be connected without Dante Controller.
- When this unit is operating at 96 kHz, up to 2 SB-16D units can be connected without Dante Controller.
- In all other cases, setting using Dante Controller will be necessary.

Procedures for Dante connection with this unit and one SB-16D

In this case, Dante connection without using Dante Controller is possible whether this unit's built-in Dante "Sampling rate" is using 48kHz or 96kHz operation. Moreover, controlling a preamp of that SB-16D from a module with a built in Dante port assigned is possible.

1. If multiple SB-16D units are connected to the Dante network, set IDs that are not duplicated on them in advance in order to enable their identification. For details about ID setting procedures, see the SB-16D operation manual.
2. Connect the following Dante ports to the same Dante network.
 - Dante ports built into this unit
 - SB-16D Dante ports

NOTE

When using only one of these units and one SB-16D, their Dante ports can be connected directly as shown below.

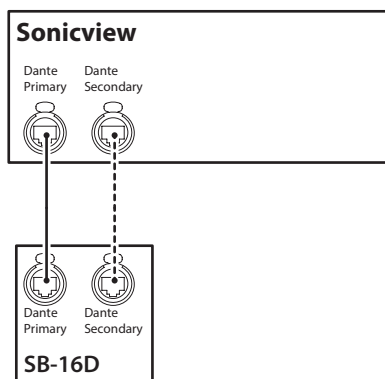

3. Set the Dante routing control method.
Tap Menu Screen > Rear Panel Setup > Dante Setup to open the Dante SETUP screen and tap the I/O Device tab.

4. Set the AUTO ROUTING button to "ON".

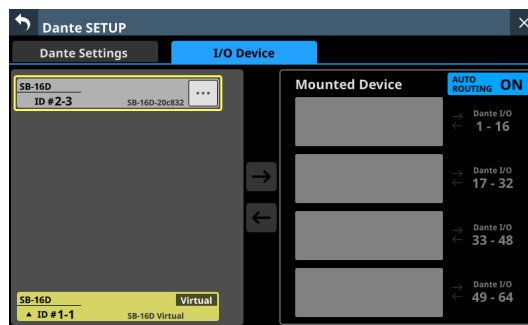

5. Follow the procedures in "Mounting of devices connected to the Dante network" on page 67, and mount the selected SB-16D as the top item in the Mounted Device list.

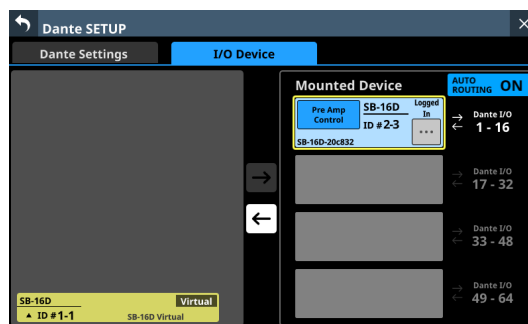

Through these procedures, the Dante I/O ports of this unit and the one SB-16D unit are routed by Dante as follows.

| Dante I/O ports of this unit | SB-16D Dante I/O ports |
|------------------------------|------------------------|
| Dante I/O 1-16 of this unit | SB-16D Dante I/O 1-16 |

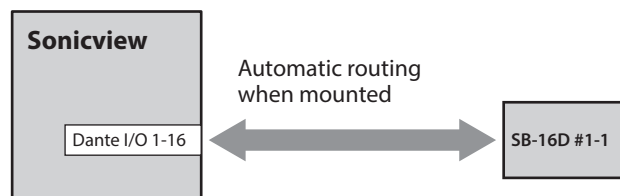

As a result, the preamps (Analog GAIN, PAD ON/OFF, Phantom ON/OFF) of the corresponding SB-16D INPUT can be operated on the Home Screen and MODULE screen of the module that has Dante IN 1-16 inputs assigned.

| Module that can operate SB-16D preamps | Object of preamp operation on the Home Screen and MODULE screen of the module (at left) |
|--|---|
| Module with Dante IN 1-16 assigned | INPUT 1-16 of the mounted SB-16D 1st in the list |

4 – Mixer configuration and settings

Procedures for connecting 4 SB-16D units by Dante when the sampling rate of this unit's built-in Dante module is "48kHz".

In this case, Dante connection without using Dante Controller is possible. Moreover, controlling a preamp of that SB-16D from a module with a built in Dante port assigned is possible.

1. If multiple SB-16D units are connected to the Dante network, set IDs that are not duplicated on them in advance in order to enable their identification. For details about ID setting procedures, see the SB-16D operation manual.
2. Connect the following Dante ports to the same Dante network.
 - Dante ports built into this unit
 - Dante ports of 4 SB-16D units

When connecting multiple SB-16D units, connect them through a switching hub as shown below. In this case, use different switching hubs for Primary and Secondary.

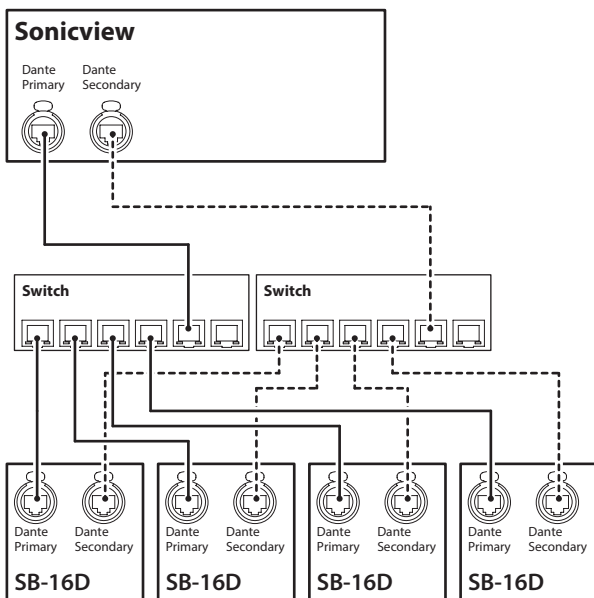

3. Set the Dante routing control method. Tap Menu Screen > Rear Panel Setup > Dante Setup to open the Dante SETUP screen and tap the I/O Device tab.
4. Set the AUTO ROUTING button to "ON".

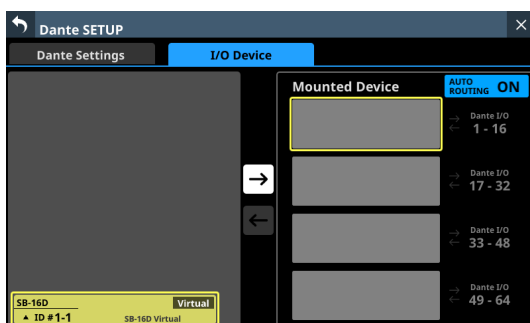

5. Following the procedures in "Mounting of devices connected to the Dante network" on page 67, mount 4 SB-16D units one at a time from the top in the Mounted Device list.

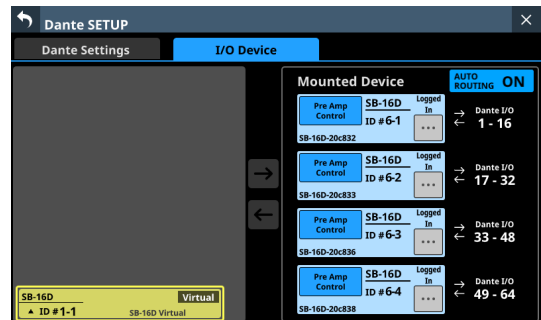

Through these procedures, the Dante I/O ports of this unit and the 4 SB-16D units are routed by Dante as follows.

| Dante I/O ports of this unit | SB-16D Dante I/O ports |
|------------------------------|--|
| Dante I/O 1-16 of this unit | Dante I/O 1-16 of the SB-16D mounted 1st in the list |
| Dante I/O 17-32 of this unit | Dante I/O 1-16 of the SB-16D mounted 2nd in the list |
| Dante I/O 33-48 of this unit | Dante I/O 1-16 of the SB-16D mounted 3rd in the list |
| Dante I/O 49-64 of this unit | Dante I/O 1-16 of the SB-16D mounted 4th in the list |

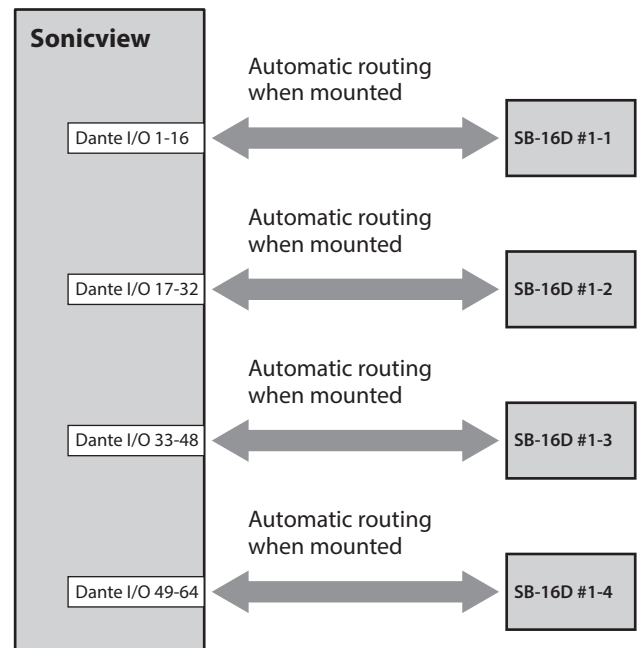

4 – Mixer configuration and settings

As a result, the preamps (Analog GAIN, PAD ON/OFF, Phantom ON/OFF) of the corresponding SB-16D INPUT can be operated on the Home Screen and MODULE screen of the module that has Dante 1–64 inputs assigned.

| Module that can operate SB-16D preamps | Object of preamp operation on the Home Screen and MODULE screen of the module (at left) |
|--|---|
| Module with Dante IN 1–16 assigned | INPUT 1–16 of the mounted SB-16D 1st in the list |
| Module with Dante IN 17–32 assigned | INPUT 1–16 of the mounted SB-16D 2nd in the list |
| Module with Dante IN 33–48 assigned | INPUT 1–16 of the mounted SB-16D 3rd in the list |
| Module with Dante IN 49–64 assigned | INPUT 1–16 of the mounted SB-16D 4th in the list |

Procedures for connecting 4 SB-16D units by Dante when the sampling rate of this unit's built-in Dante module is "96kHz".

- In this case, using Dante Controller is necessary.
 - When the "Sampling rate" Sync Clock is set to "96kHz" for the unit's built-in Dante module, the unit's built-in Dante I/O count becomes 32-in/32-out. For this reason, an IF-DA64 (Dante card) must be installed in a card slot in order to connect this unit by Dante with SB-16D input and output ports numbered 33 and higher. This explanation assumes that an IF-DA64 has been installed in SLOT 1. (See "Installing expansion cards (sold separately)" on page 32.)
1. If multiple SB-16D units are connected to the Dante network, set IDs that are not duplicated on them in advance in order to enable their identification. For details about ID setting procedures, see the SB-16D operation manual.
 2. Follow the instructions in "Precautions when using an IF-DA64" on page 93 to enable synchronization of the two Dante modules (built-in Dante and IF-DA64 Dante card) with this unit's master clock.
 3. Connect the following Dante ports to the same Dante network.
 - Dante ports built into this unit
 - Dante ports of IF-DA64 installed in this unit
 - Dante ports of 4 SB-16D units

When connecting multiple SB-16D units, connect them through a switching hub as shown below. In this case, use different switching hubs for Primary and Secondary.

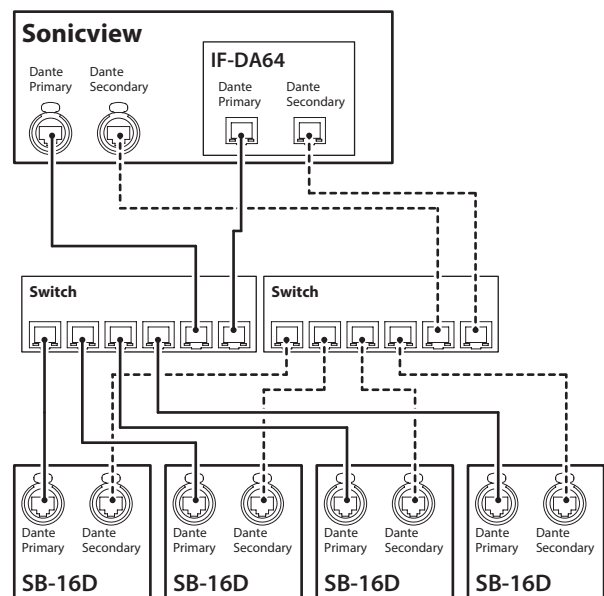

4. Set the Dante routing control method.
Tap Menu Screen > Rear Panel Setup > Dante Setup to open the Dante SETUP screen and tap the I/O Device tab.

4 – Mixer configuration and settings

- Set the AUTO ROUTING button to "ON".

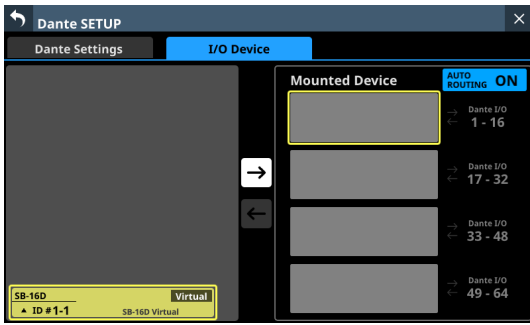

- Following the procedures in "Mounting of devices connected to the Dante network" on page 67, mount 4 SB-16D units one at a time from the top in the Mounted Device list.

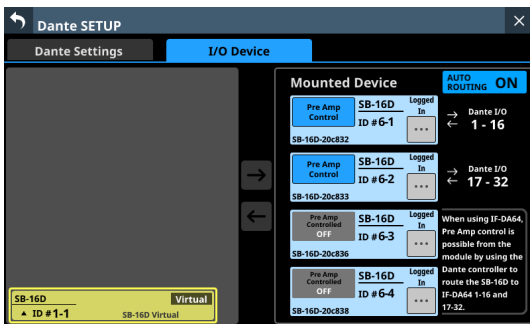

- Use Dante Controller on the computer connected to the Dante network in step 3 to make the following connection routing settings.
 - Connect Dante I/O 1–16 of the IF-DA64 installed in this unit to Dante I/O 1–16 of the SB-16D mounted 3rd from the top
 - Connect Dante I/O 17–32 of the IF-DA64 installed in this unit to Dante I/O 1–16 of the SB-16D mounted 4th from the top

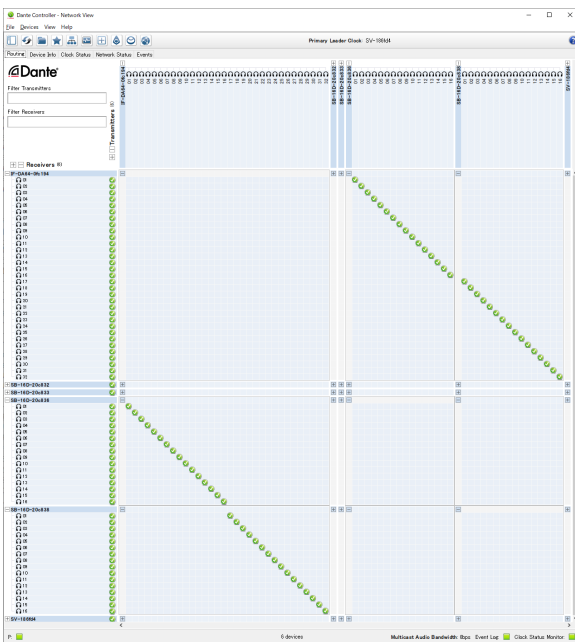

As a result, the Dante I/O ports of this unit's built-in Dante, the IF-DA64 (Dante card) installed in this unit's SLOT 1 and the 4 SB-16D units are routed by Dante as follows.

| Dante I/O ports of this unit | SB-16D Dante I/O ports |
|-------------------------------|--|
| Dante I/O 1–16 of this unit | Dante I/O 1–16 of the SB-16D mounted 1st in the list |
| Dante I/O 17–32 of this unit | Dante I/O 1–16 of the SB-16D mounted 2nd in the list |
| SLOT 1 I/O 1–16 of this unit | Dante I/O 1–16 of the SB-16D mounted 3rd in the list |
| SLOT 1 I/O 17–32 of this unit | Dante I/O 1–16 of the SB-16D mounted 4th in the list |

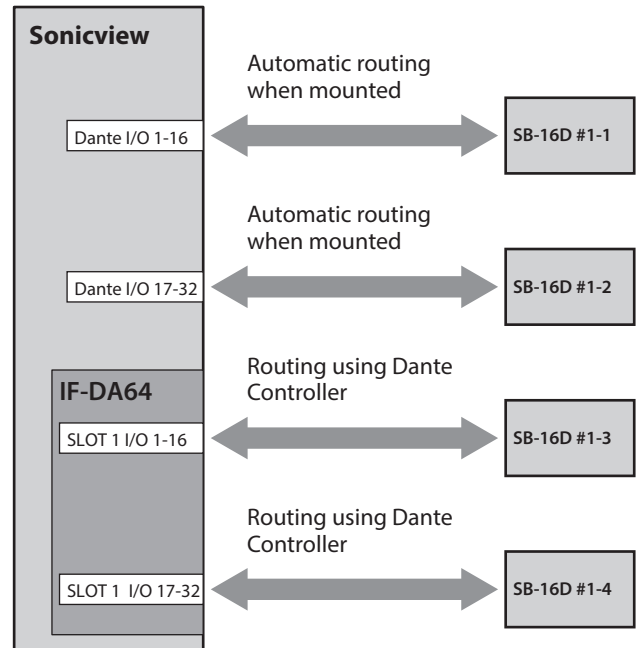

- Acquire control privileges to enable operation of SB-16D units mounted 3rd and 4th from the top and routed through an IF-DA64 from the Home and MODULE screens of this unit. Tap the "Pre Amp Control OFF" buttons for the 3rd and 4th devices to open the following confirmation message.

- If control privileges for those SB-16D units have not been acquired by other devices: The following message will be shown.

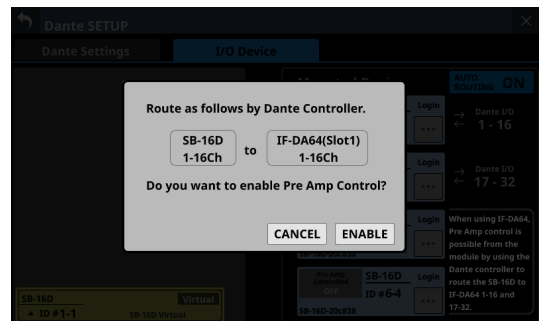

Tapping the ENABLE button will set the control privileges and "Pre Amp Control" will be shown in the control privilege display area.

4 – Mixer configuration and settings

- If control privileges for those SB-16D units have been acquired by other devices:
The following message will be shown.

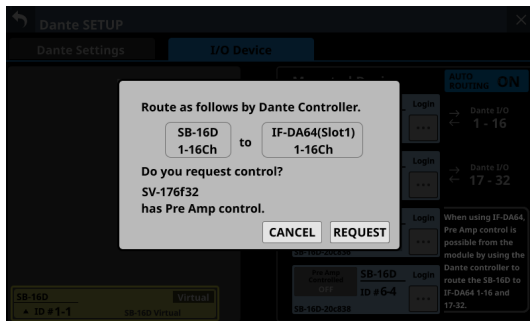

Tapping the REQUEST button and following the procedures from step 5 in “Mounting of devices connected to the Dante network” on page 67 to acquire the control privileges will cause “Pre Amp Control” to be shown in the control privilege display area.

9. Conduct step 9 for the SB-16D units mounted 3rd and 4th in the list.
This will enable operation from this unit of SB-16D units mounted 3rd and 4th from the top and routed through an IF-DA64.

After completing these procedures, the preamps (Analog GAIN, PAD ON/OFF, Phantom ON/OFF) of the corresponding SB-16D units can be operated on the Home Screens and MODULE screens of the modules that have Dante 1–32 and SLOT 1-1 1–32 input ports assigned.

| Module that can operate SB-16D preamps | Object of preamp operation on the Home Screen and MODULE screen of the module (at left) |
|--|---|
| Module with Dante IN 1–16 assigned | INPUT 1–16 of the mounted SB-16D at the top of the list |
| Module with Dante IN 17–32 assigned | INPUT 1–16 of the mounted SB-16D 2nd in the list |
| Module with SLOT 1 IN 1–16 assigned | INPUT 1–16 of the mounted SB-16D 3rd in the list |
| Module with SLOT 1 IN 17–32 assigned | INPUT 1–16 of the mounted SB-16D 4th in the list |

ATTENTION

In these procedures, maintain the routing settings of the SB-16D units mounted 3rd and 4th from the top and the IF-DA64 (Dante card) as follows.

- Connect Dante I/O 1–16 of the IF-DA64 installed in this unit to Dante I/O 1–16 of the SB-16D mounted 3rd from the top
- Connect Dante I/O 17–32 of the IF-DA64 installed in this unit to Dante I/O 1–16 of the SB-16D mounted 4th from the top

If routings are changed from the above by Dante Controller, the preamp of an unintended SB-16D channel will be affected if a preamp is operated on this unit from the Home Screen or MODULE screen of a module with a corresponding SLOT input assigned.

Procedures to connect one SB-16D and a DA-6400* with an IF-DA64 (Dante card) installed to this unit by Dante

* In this example, connection is with Dante I/O 1–16 of a DA-6400 with an IF-DA64.

In this case, using Dante Controller is necessary.

1. If multiple SB-16D units are connected to the Dante network, set IDs that are not duplicated on them in advance in order to enable their identification. For details about ID setting procedures, see the SB-16D operation manual.
2. Connect the following Dante ports to the same Dante network.
 - Dante ports built into this unit
 - SB-16D Dante ports
 - Dante ports of the IF-DA64 installed in the DA-6400

When connecting 3 or more Dante devices, connect them through a switching hub as shown below. In this case, use different switching hubs for Primary and Secondary.

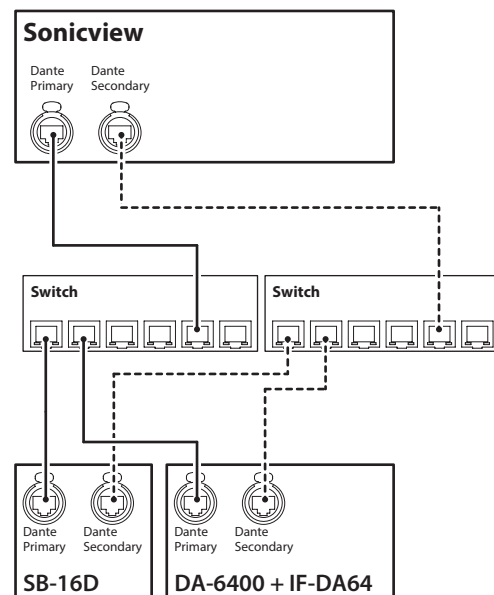

3. Set the Dante routing control method.
Tap Menu Screen > Rear Panel Setup > Dante Setup to open the Dante SETUP screen and tap the I/O Device tab.
4. Set the AUTO ROUTING button to “ON”.

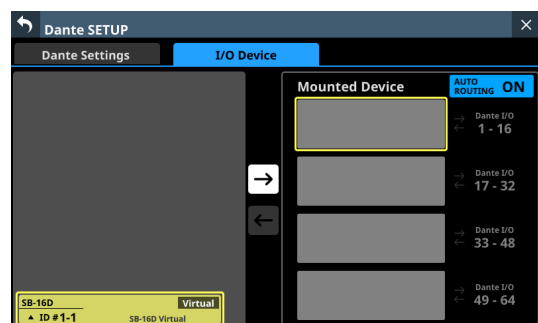

4 – Mixer configuration and settings

- Follow the procedures in “Mounting of devices connected to the Dante network” on page 67, and mount the SB-16D as the top item in the Mounted Device list.

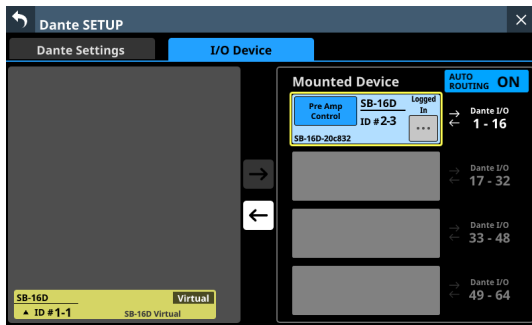

- Change the Dante routing control method.
- Set the AUTO ROUTING button to “OFF”.
- Use Dante Controller on the computer connected to the Dante network in step 2 to make the following (A) and (B) connection routing settings.
 - (A) Dante I/O 17–32 of this unit
 - (B) Dante I/O 1–16 of the IF-DA64 installed in the DA-6400

Example of Dante Controller display when routing settings have been made connecting this unit’s Dante I/O 17–32 and Dante I/O 1–16 of the IF-DA64 installed in the DA-6400

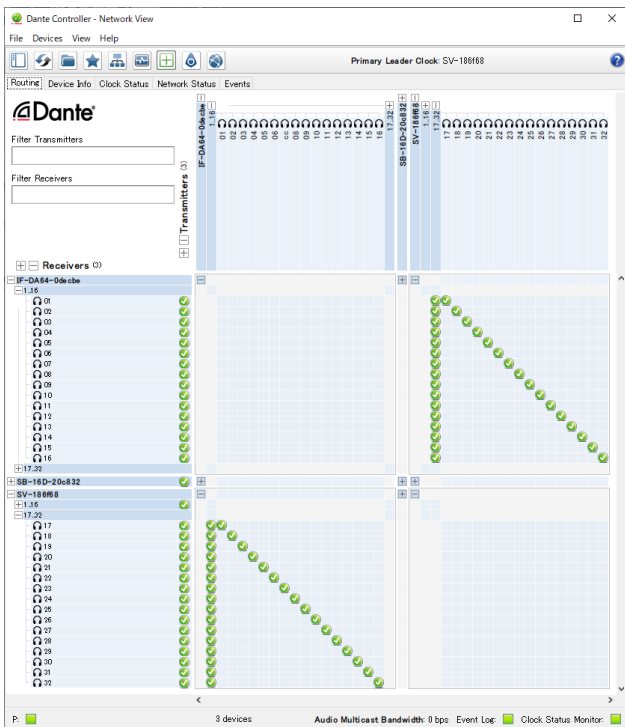

Through these procedures, the Dante I/O ports of this unit, the SB-16D and the IF-DA64 (Dante card) installed in the DA-6400 are routed by Dante as follows.

| Dante I/O ports of this unit | Dante I/O ports of external devices |
|------------------------------|--|
| Dante I/O 1–16 of this unit | Dante I/O 1–16 of the SB-16D mounted 1st in the list |
| Dante I/O 17–32 of this unit | Dante I/O 1–16 of the IF-DA64 installed in the DA-6400 |

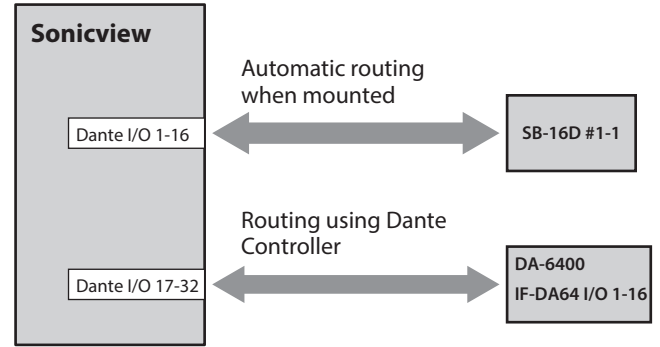

Example of Dante Controller display when the above routing settings have been made

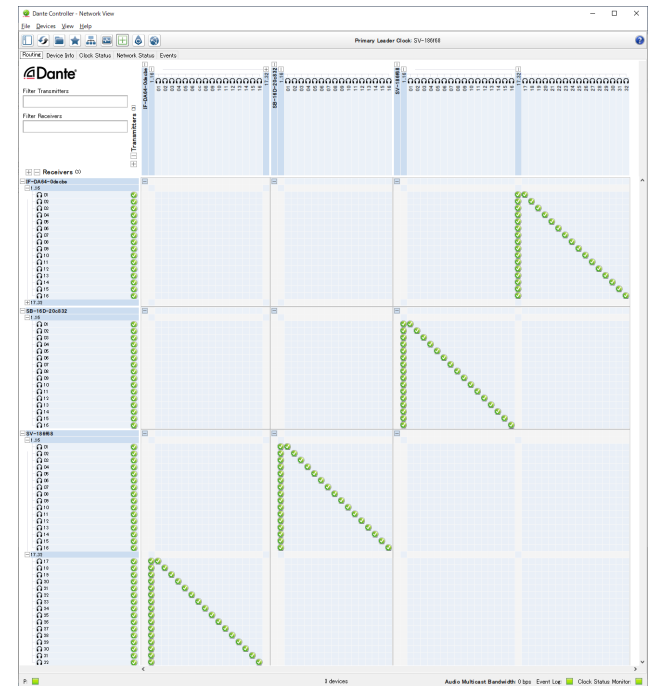

After completing these procedures, operation becomes possible for the preamps (Analog GAIN, PAD ON/OFF, Phantom ON/OFF) of the corresponding SB-16D INPUT on the Home Screen and MODULE screen of the module that has Dante IN 1–16 input ports assigned.

| | |
|---|--|
| Module that can operate SB-16D preamps | Object of preamp operation on the Home Screen and MODULE screen of the module (at left) |
| Module with Dante IN 1–16 assigned | INPUT 1–16 of the mounted SB-16D at the top of the list |

4 – Mixer configuration and settings

Notes about Dante

Dante is a transmission protocol developed by Audinate. Using networks based on gigabit Ethernet standards, it enables multichannel (512 IN/512 OUT) transmission and high precision, for example.

Check the Audinate website for details about Dante.
<https://www.audinate.com/>

Connecting to a Dante network

In order to set up and use this unit, you must also set up the Ethernet network that it is connected to, a computer that runs Dante Controller and other devices that support Dante. Dante controller is not necessary for use, however, when used with an SB-16D.

LAN cables used for connections

Use STP cables that are category 5e or higher. Both crossover and straight cables can be used.

ATTENTION

This unit is not compatible with 100Mbps Ethernet switching hubs. Always use switching hubs that support Gigabit Ethernet.

NOTE

- When the Dante Network Addressing setting is AUTO (DHCP), set the computer to set the IP address automatically.
- When the Dante Network Addressing setting is STATIC, set the computer to match the Dante and network address.

Switched (daisy chain) connection

Dante devices can be daisy-chained when there are few connected devices and when not using a switching hub. Connect them as shown below.

Switched (daisy chain) connection example



NOTE

- When using a switched (daisy chain) connection, connect to either the PRIMARY or SECONDARY connector.
- If the number of connected devices increases, raising the latency setting will be necessary.

Redundant connection

For recording situations where retakes are not possible, including live performances, a connection set up like the following uses two completely independent primary and secondary networks.

Redundant connection example

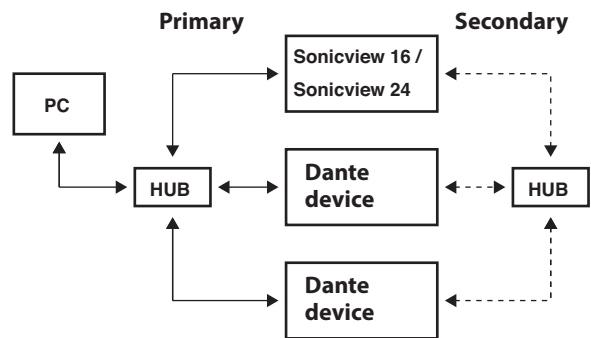

NOTE

Settings for switched (daisy chain) and redundant connections do not change automatically. Tap Menu Screen > Rear Panel Setup > Dante Setup to open the Dante SETUP Screen, or change the settings on the Dante Controller Network Config screen.

ATTENTION

The primary and secondary networks cannot be connected on the same LAN (VLAN).

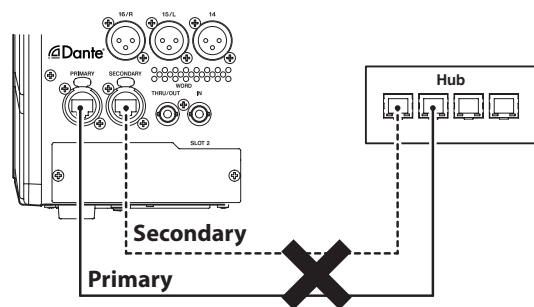

4 – Mixer configuration and settings

Using Dante Controller

Dante Controller overview

This unit uses the Dante Controller application, which is available at the Audinate website, to connect with other devices that support Dante.

Download the latest version of the Dante Controller application and an operation manual from the Audinate website.

Audinate download page

<https://www.audinate.com/products/software/dante-controller>

Make at least the following settings using a computer that has Dante Controller installed.

- Set the audio routing.
- Adjust the sampling frequency and bit depth of each Dante device.

NOTE

Settings made using Dante Controller are stored in the built-in memory of each Dante device.

Unless settings are modified, connections will not change even if Dante Controller is quit or the computer is disconnected from the Dante network.

Audio routing settings

When Dante Controller is launched, the Network View screen shown below will open.

On this screen, you can set and monitor conditions related to the Dante network.

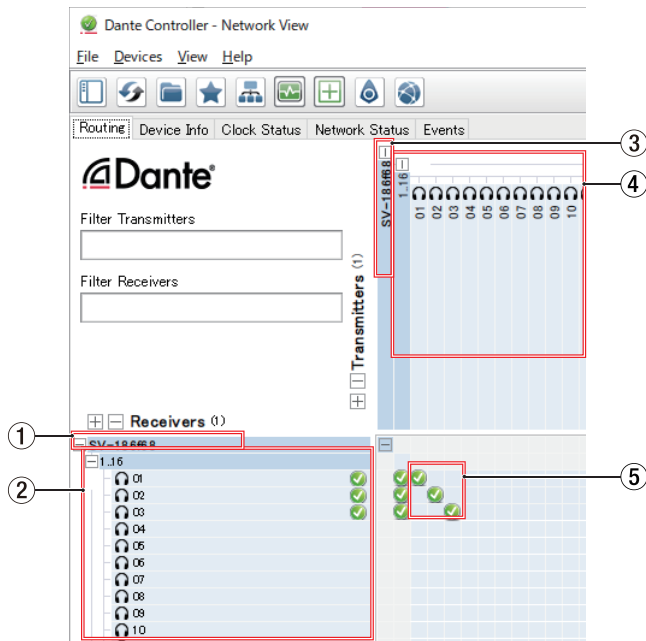

- ① **Receiving device name**
This is the name of a receiving device on the Dante network.
- ② **Receiving device channels**
These are the names of the channels of the receiving device on the Dante network.
- ③ **Transmitting device name**
This is the name of a transmitting device on the Dante network.

- ④ **Transmitting device channels**
These are the names of the channels of the transmitting device on the Dante network.

- ⑤ **Audio routing**
Route the audio channels of the transmitting and receiving devices that you want to connect here.
Click the intersection of the channels you want to connect on the matrix to connect them.

NOTE

While pressing the computer keyboard Ctrl key, click the “-” at the intersection of device names to connect all connectable channels at once.

Changing sampling frequencies and bit depths with Dante Controller

Double-click a device name on the Network View screen to open the Device View screen.

On this screen, you can set and monitor conditions related to devices on the Dante network.

Click the Device Config tab to open the page where you can change the sampling frequency, bit rate and other settings of the device selected in ① shown in the illustration below.

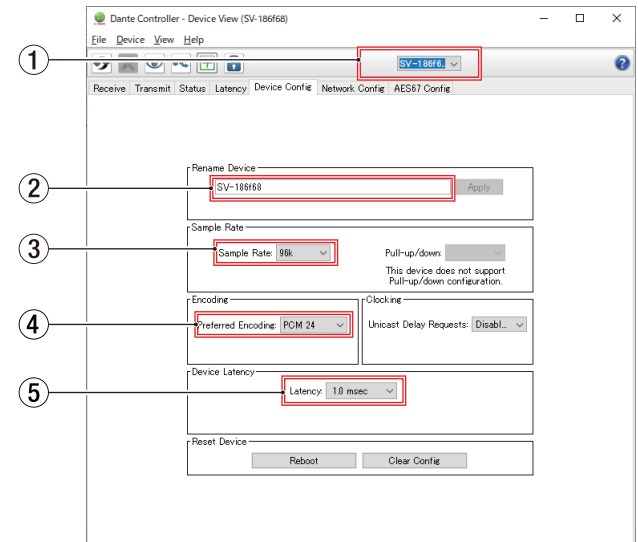

- ① **Device name**
This is the name of the device that can have its settings changed in the current Device View.
- ② **Change device name**
Edit the device name.
- ③ **Sampling frequency**
Set the sampling frequency.

NOTE

This can also be set on the unit.

- ④ **Bit depth**
Set the bit depth.

4 – Mixer configuration and settings

⑤ Latency setting

Set the latency.

Use the following guidelines to change the latency setting.

| Selectable latency value | Connected network setup guideline |
|--------------------------|--|
| 250usec | The transmission route from the transmitting device to the receiving device passes through 1 gigabit switching hub. |
| 500usec | The transmission route from the transmitting device to the receiving device passes through 5 gigabit switching hub. |
| 1msec | The transmission route from the transmitting device to the receiving device passes through 10 gigabit switching hub. |
| 2msec | The transmission speed of the transmitting device is 100 Mbps. |
| 5msec | Use this maximum selectable latency value when creating a large-scale network. |

ATTENTION

- This unit is not compatible with 100Mbps Ethernet switching hubs. Always use switching hubs that are compatible with Gigabit Ethernet.
- Changing the name of a device will clear audio routing settings. For this reason, we recommend changing device names to names that are easy to identify before setting audio routings.
- Depending on network connection conditions, setting the latency to a value higher than the guideline might be necessary.

NOTE

- This can also be set on the unit.
- When using a switched (daisy chain) connection, which does not use a switching hub, set the latency according to the number of Dante devices that signals pass-through as shown below.

Switched (daisy chain) connection example

Passes through 2 devices

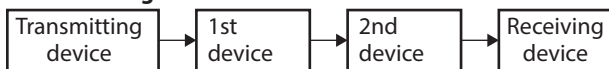

Passes through 1 devices



NOTE

The Dante module in this unit and IF-DA64 Dante cards (sold separately) have built-in switching hubs. For this reason, when counting Dante devices, count this unit and IF-DA64 cards as two devices each.

SLOT SETUP screen

Make settings and view information for expansion cards installed in SLOT 1 and SLOT 2 on this screen.

Tap Menu Screen > Rear Panel Setup > Slot Setup to open this screen.

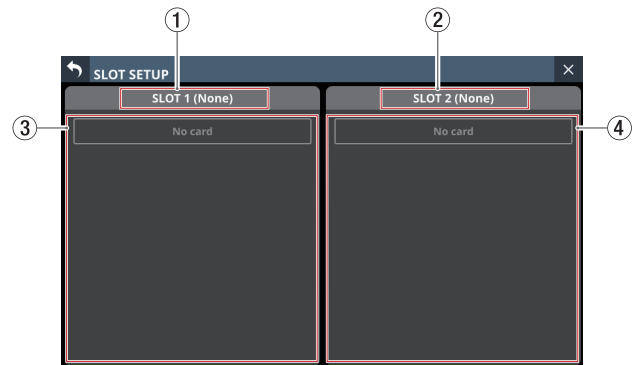

① SLOT 1

This shows the name of the expansion card installed in SLOT 1 on the rear panel.

② SLOT 2

This shows the name of the expansion card installed in SLOT 2 on the rear panel.

③ SLOT 1 parameters

This shows the parameters of the expansion card installed in SLOT 1 on the rear panel.

④ SLOT 2 parameters

This shows the parameters of the expansion card installed in SLOT 2 on the rear panel.

NOTE

“No Card” will appear if no card has been installed in SLOT 1 or SLOT 2.

When an IF-DA64 (Dante) card is installed

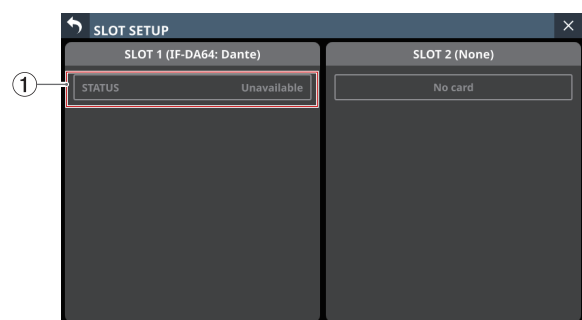

① STATUS

This shows the operation status of the installed IF-DA64.

| STATUS | Meaning |
|-------------|--|
| Available | The installed IF-DA64 is operating normally. |
| Unavailable | The installed IF-DA64 is not operating normally. |

4 – Mixer configuration and settings

Precautions when using an IF-DA64

The Dante module built into this unit, an IF-DA64 Dante card installed in a SLOT and the unit's master clock must be synchronized. Do this as follows.

- When the unit's master clock is not Dante (INT, WORD, etc.)
Use Dante Controller to set the Sync to External setting to "ON" for both the built-in Dante module and the IF-DA64.
Use Dante Controller to set the Preferred Leader setting to "ON" for either one of them. (We recommend using the built-in Dante module.)

Master clock: Not Dante (WORD, etc.)

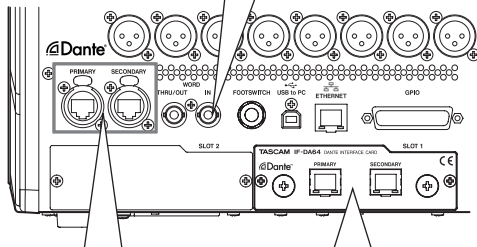

| | |
|--|---|
| Built-in Dante module Sync to External: ON Preferred Leader: ON | IF-DA64 Sync to External: ON Preferred Leader: OFF |
|--|---|

- When the unit's master clock is Dante
Use Dante Controller to set the Sync to External setting to "ON" for the IF-DA64.
Use Dante Controller to set the Preferred Leader setting to "ON" for a Dante module other than an IF-DA64. (We recommend using the built-in Dante module.)

Master clock: Dante

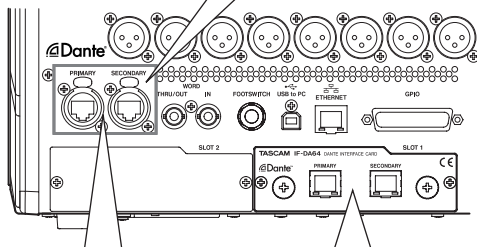

| | |
|---|---|
| Built-in Dante module Sync to External: OFF Preferred Leader: ON | IF-DA64 Sync to External: ON Preferred Leader: OFF |
|---|---|

When an IF-AE16 (AES/EBU) card is installed

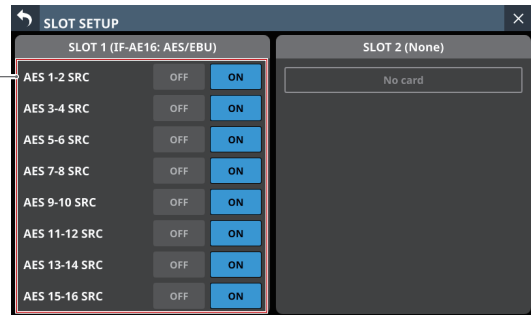

- SRC ON/OFF buttons**
These turn the SRC (sample rate converter) ON (default) and OFF for each signal line.
The selected buttons will be highlighted.

When an IF-MA64/EX or IF-MA64/BN (MADI) card is installed

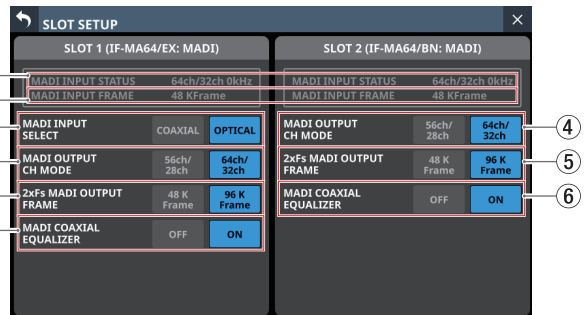

- MADI INPUT STATUS**
This shows the channel mode/frame frequency of the MADI input signal.
"No signal" will appear if there is no input signal.
- MADI INPUT FRAME**
This shows the MADI input signal frame type (48K Frame/96K Frame).
"No signal" will appear if there is no input signal.
- MADI INPUT SELECT buttons (IF-MA64/EX only)**
Set the input connector used.
Options: COAXIAL, OPTICAL (default)
The selected button will be highlighted.
- MADI OUTPUT CH MODE buttons**
Set the output channel mode.
Options: 56ch/28ch, 64ch/32ch (default)
The selected button will be highlighted.

NOTE

- Left of /: 1×Fs channel mode
- Right of /: 2×Fs channel mode

4 – Mixer configuration and settings

⑤ 2×Fs MADI OUTPUT FRAME buttons

These set the MADI output signal frame type when the unit's sampling frequency is 96 kHz.

Options: 48K Frame, 96K Frame (default)

The selected button will be highlighted.

ATTENTION

A MADI signal with a 96kHz sampling frequency and 48K Frame type cannot be distinguished from a MADI signal with a 48kHz sampling frequency.

For this reason, a 48K Frame MADI input signal that does not match the sampling frequency of the receiving device cannot be received as proper audio data.

When using a 48K Frame MADI signal, always match the sampling frequencies of the signal sending and receiving devices.

NOTE

The signal from the IF-MA64/EX MADI COAXIAL IN connector is output through its MADI COAXIAL THRU connector whether the unit is on or off.

When the unit is turned on/off, however, the signal output from the MADI COAXIAL THRU connector will be momentarily disrupted.

For this reason, time turning the unit on/off carefully when the signal output from the MADI COAXIAL THRU connector is being used by a connected device.

⑥ MADI COAXIAL EQUALIZER buttons

Set the equalizer for MADI COAXIAL input signals.

When an IF-MA64/EX or IF-MA64/BN is connected and a low-voltage MADI COAXIAL signal source or long BNC cable is being used, proper reception is not possible sometimes. In this case, try setting MADI COAXIAL EQUALIZER to OFF.

Options: OFF, ON (default)

The selected button will be highlighted.

When an IF-AN16/OUT (analog output) card is installed

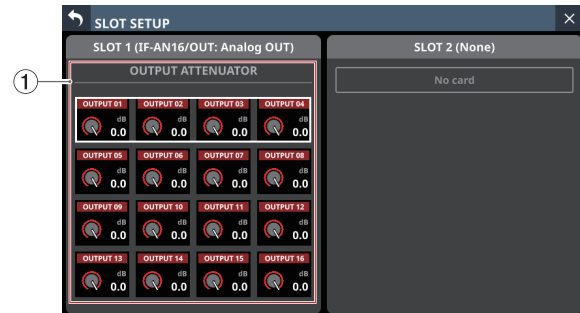

① OUTPUT ATTENUATOR knobs

These adjust the output levels.

Range: -14.0 dB – 0.0 dB (default)

When the selection frame is shown, use the corresponding LCD knobs to adjust the values.

NOTE

The IF-AN16/OUT will always operate at 96 kHz even when synchronized to a master clock that is 48 kHz.

When an IF-MTR32 (multitrack recording) card is installed

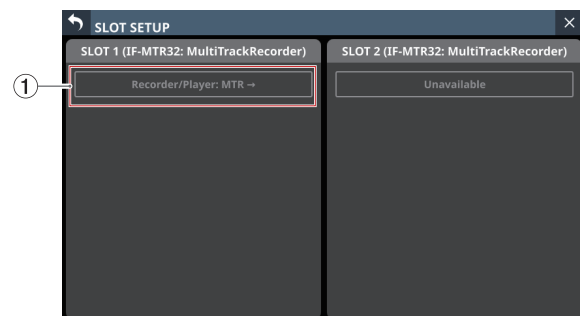

SLOT SETUP screen when 2 IF-MTR32 cards installed

① Recorder/Player: MTR →

Tap this area to open the MULTI TRACK RECORDER Screen. (See "MULTI TRACK RECORDER Screen" on page 217.)

ATTENTION

Only one IF-MTR32 card can be used at a time.

If two IF-MTR32 cards are installed, only the one in SLOT 1 can be used. In this case, "Unavailable" will appear in the SLOT 2 area on the SLOT SETUP Screen.

4 – Mixer configuration and settings

Network Setup screen

Use this screen to make network settings primarily for the purpose of remote control of this unit using the dedicated TASCAM Sonicview Control application.

For details about the TASCAM Sonicview Control application, see its manual. You can download the application manual from the TEAC Global Site (<https://teac-global.com/>).

Tap Menu Screen > Rear Panel Setup > Network Setup to open this screen.

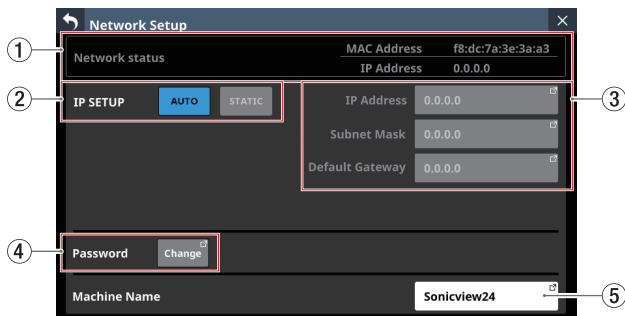

1 Network status

This shows the network status of the unit.

| Item | Content |
|-------------|------------------------------------|
| MAC Address | This shows the unit's MAC address. |
| IP Address | This shows the unit's IP address. |

2 IP SETUP

Set the IP address setting mode.

Options: AUTO (default), STATIC

3 IP Address/Subnet Mask/Default Gateway

- This shows the IP Address, Subnet Mask and Default Gateway of the unit when IP SETUP is "STATIC".
default: 0.0.0.0
- This will be gray when IP SETUP is "AUTO".
- Tap the address fields to open the IP Address, Subnet Mask and Default Gateway screens.

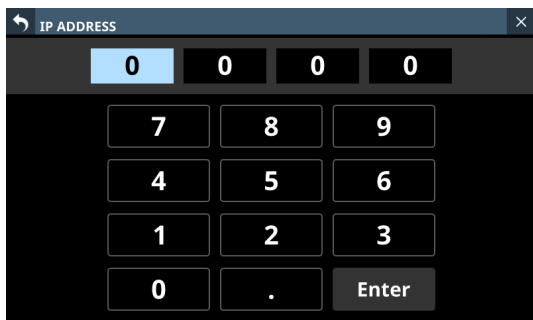

IP ADDRESS setting screen

See "IP Address/Subnet Mask/Default Gateway setting procedures" on page 96 for details about how to use these setting screens.

4 Password

Set the password to use when connecting to this unit through a network.

Tap the Change button to open the Change password screen.

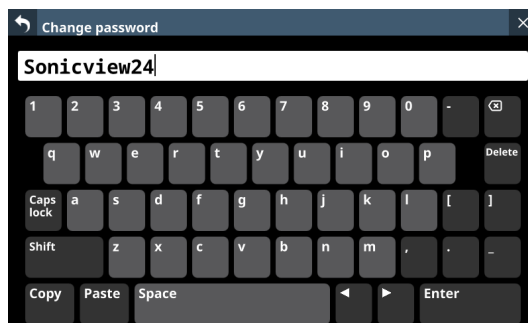

The password can have up to 16 characters.

| Model | Default password |
|--------------|------------------|
| Sonicview 16 | Sonicview16 |
| Sonicview 24 | Sonicview24 |

The combination of characters input can be changed depending on the status of the Caps lock and Shift keyboard buttons on the Change password screen. See "Changing the keyboard keys" on page 167 for details about changing the keyboard.

ATTENTION

The following symbols and punctuation marks cannot be input.

¥ / : * ? " < > |

NOTE

A USB keyboard that is connected to the top panel USB port can also be used to input and edit characters.

4 – Mixer configuration and settings

⑤ Machine Name

The name of the unit on the network can be set so remote applications can distinguish it from other Sonicview units when multiple ones are on the network.

Tap this area to open the Machine name screen.

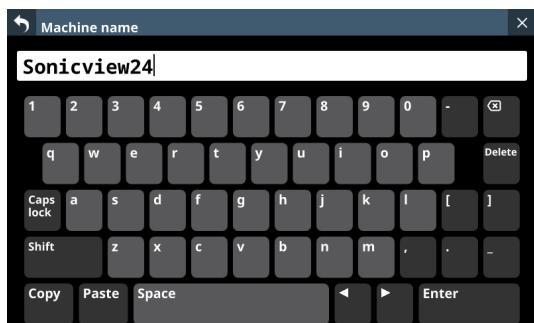

The machine name can have up to 16 characters.

| Model | Default machine name |
|--------------|----------------------|
| Sonicview 16 | Sonicview16 |
| Sonicview 24 | Sonicview24 |

The combination of characters input can be changed depending on the status of the Caps lock and Shift keyboard buttons on the Machine name screen. See "Changing the keyboard keys" on page 167 for details about changing the keyboard.

ATTENTION

The following symbols and punctuation marks cannot be input.

¥ / : * ? " < > |

NOTE

A USB keyboard that is connected to the top panel USB port can also be used to input and edit characters.

IP Address/Subnet Mask/Default Gateway setting procedures

The IP address is set to "192.168.1.1" as an example in this explanation.

1. Tap the IP Address, Subnet Mask and Default Gateway fields to open their setting screens.

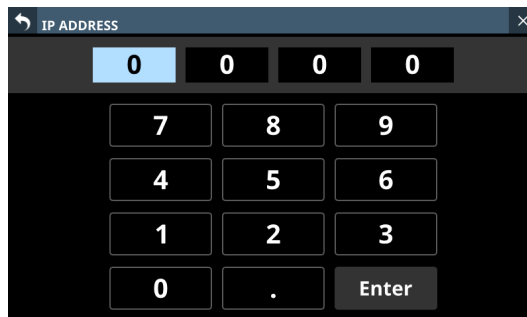

2. Tap the number buttons to input setting values.



3. Tap "." to move the cursor to the next field. To change a setting, tap it to move the cursor to that field.



4. Repeat steps 2–3 as necessary to input setting values in each field.

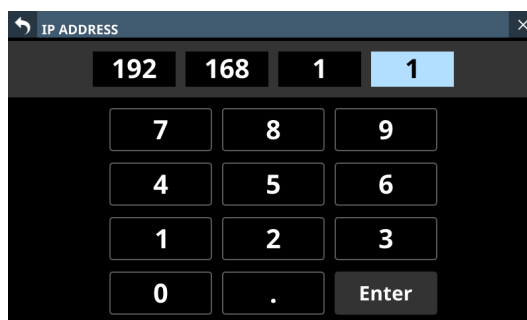

4 – Mixer configuration and settings

- Tap the Enter button to confirm the input and return to the Network Setup Screen. Changed settings will be reflected in the IP Address, Subnet Mask and Default Gateway fields of the Network Setup Screen.

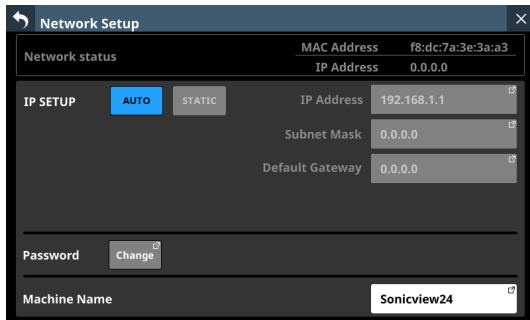

NOTE

- Each input field has three digits. When inputting values with less than three digits, inputting “0” first is not necessary.
- After this screen opens, the first field will be highlighted.
- When a field is highlighted, tapping a number button will input that number, replacing the value previously in the field. After this, input numbers as on a calculator.
- If a fourth digit is entered, the first digit entered will be removed. For example, if “1234” was entered, “1” will be removed.

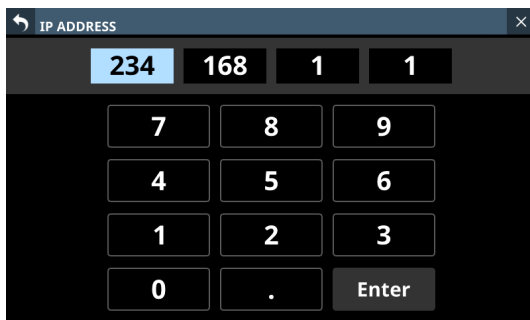

Saving the current settings

The settings of the unit are saved to the internal memory at least once every minute.

To be certain that the unit settings are saved in the internal memory before turning the power off, use the Save Current Settings function explained below.

NOTE

After saving All System Data or storing snapshot, EQ and other library settings data, settings have already been output to the memory, so these operations are not necessary before turning the power off.

- Press the MENU key to open the Menu Screen.
- On the Menu Screen, show the Save Current Settings item.
- Tap the Save Current Settings item to open a saving confirmation message to the right of the menu list.

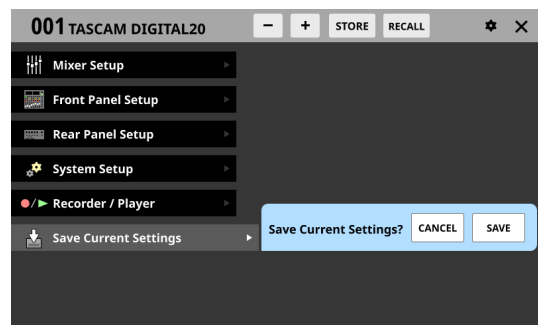

- Tap the SAVE button to save the unit’s settings to its internal memory.
- The message shown below will appear while saving.

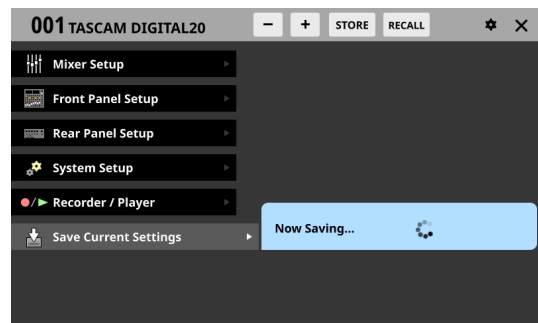

- “Saved.” will momentarily appear after saving completes and then this message will disappear.

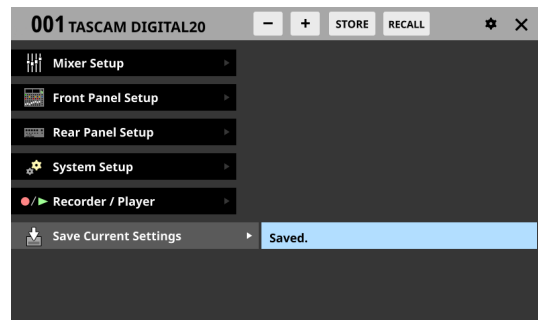

5 – Routing

This chapter explains mixer input and output routing.

Input routing

Use the following screen for input routing.

CH 1–40/ST IN 1–2 MODULE (OVERVIEW) Screens

Tap the MODULE NAME area on the Home Screen to open this screen.

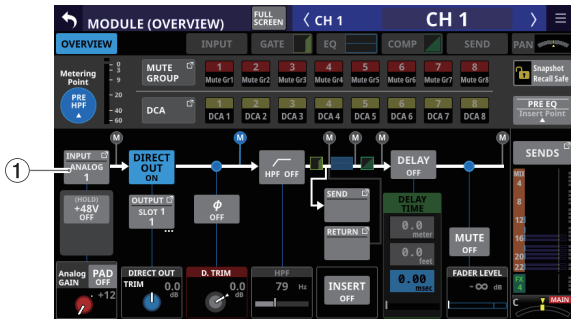

CH 1–40 modules

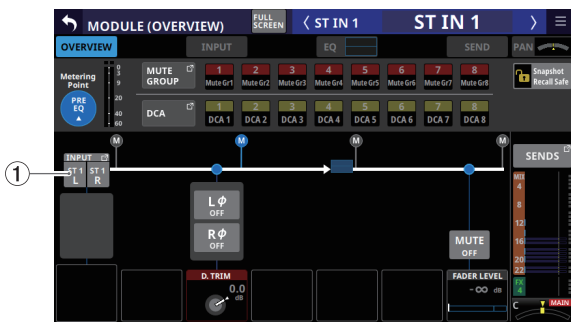

ST IN 1–2 modules

① INPUT button

- This shows the name of the input source assigned to the selected module.
- If the module is stereo, input source names will appear split left and right and abbreviated as follows.

| Module name shown | Stereo module name shown |
|-------------------|--------------------------|
| ANALOG | AN |
| Dante | DA |
| SLOT 1 | S1 |
| SLOT 2 | S2 |
| USB IN | USB |
| ST IN 1 | ST1 |
| ST IN 2 | ST2 |
| PLAYER | PL |
| SB-16D | SB |

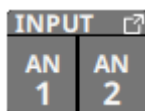

- If a Dante port that has a mounted SB-16D assigned is selected, “SB #[ID] [port number]” will be shown.

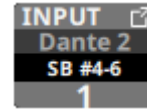

If it is a virtually-mounted SB-16D,  will appear.



- Tap this button to open the INPUT SOURCE SELECT Screen where input sources can be selected. (See “INPUT SOURCE SELECT screen” on page 106.)

CH 1–40/ST IN 1–2 MODULE (INPUT) Screens

Tap the INPUT area on the Home Screen of a CH 1–40/ST IN 1–2 module when the selection frame is shown to open this screen.

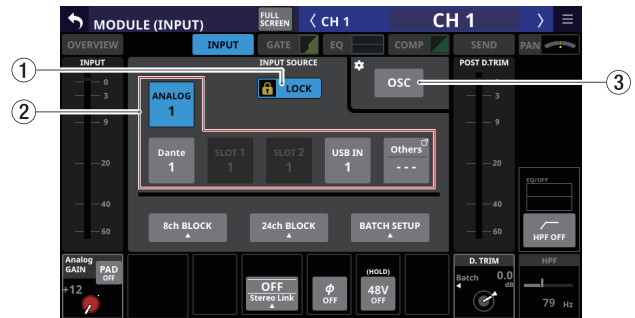

CH 1–40 modules

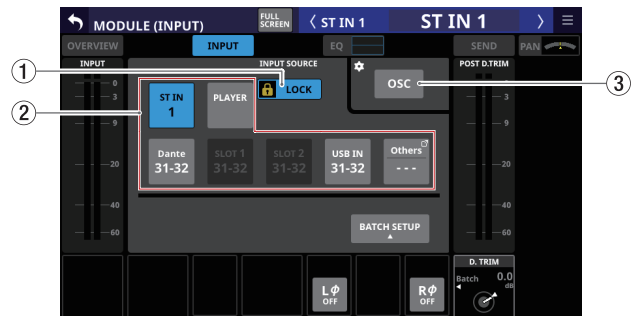

ST IN 1–2 modules

① LOCK/UNLOCK button

- This button locks/unlocks routing setting change operations for the unit. This is always locked at the time of start up.
- When set to “LOCK”, tapping INPUT SOURCE (②) and OSC (③) buttons will not change settings. Furthermore, the 8ch BLOCK, 16ch BLOCK, 24ch BLOCK and BATCH SETUP buttons will also be disabled. However, tapping the Others button and switching to the INPUT SOURCE SELECT Screen is possible.
- When set to “LOCK”, tap this button to open a confirmation message. Tap the UNLOCK button to close the message and set it to “UNLOCK”. Tapping the CANCEL button on the confirmation message will close it and maintain the locked state.

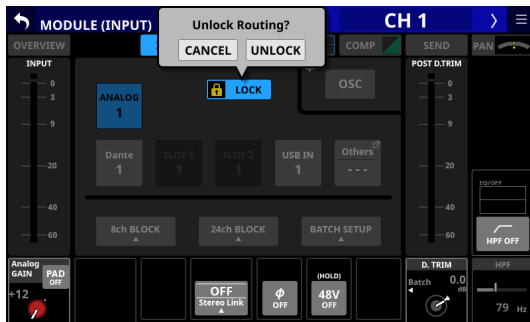

- Tap this button when set to “UNLOCK” to switch it to “LOCK”.

NOTE

The LOCK/UNLOCK button (①) setting is shared by the following routing setting screens.

- MODULE (INPUT) Screen
- MODULE (OUTPUT) Screen
- INPUT SOURCE SELECT Screen
- OUTPUT PORT SELECT Screen
- DIRECT OUT PORT SELECT Screen
- INSERT SEND PORT SELECT Screen
- INSERT RETURN PORT SELECT Screen

② INPUT SOURCE buttons

- When the LOCK/UNLOCK button (①) is set to “UNLOCK”, tap input sources to select them for the selected module. Only the one button for the selected input source will be highlighted.
- Buttons for Dante ports that have mounted SB-16Ds assigned will be shown as “SB #[ID] [port number]”.



If it is a virtually-mounted SB-16D,  will appear to the top right.



- Assigned buttons for Dante ports that have virtually-mounted SB-16Ds will be highlighted yellow.



- If the selected input source is not shown elsewhere on this screen, it will be shown on the Others button.

- If the module is stereo and input sources that are not left-right adjacent are selected, input source names will appear split left and right and abbreviated as follows on the Others button.

| Module name shown | Stereo module name shown |
|-------------------|--------------------------|
| ANALOG | AN |
| Dante | DA |
| SLOT 1 | S1 |
| SLOT 2 | S2 |
| USB IN | USB |
| ST IN 1 | ST1 |
| ST IN 2 | ST2 |
| PLAYER | PL |

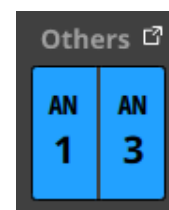

- Tap the Others button to open the INPUT SOURCE SELECT Screen where input sources not shown on this screen can be selected. (See “INPUT SOURCE SELECT screen” on page 106.)

NOTE

Input sources for multiple channels can also be set at the same time. (See “Setting input sources for multiple channels at the same time in blocks” on page 100 and “Setting inputs sources for multiple channels at the same time in batches” on page 100.)

③ OSC button

- When the LOCK/UNLOCK button (①) is set to “UNLOCK”, tap this button to turn internal oscillator signal input on or off (default).
- When turned on, the input for the selected module will switch to the signal from the internal oscillator. When on, this button will appear highlighted, and the INPUT SOURCE selection (②) button area will be dimmed.
- When this is turned off, the input source selected for the selected module using the INPUT SOURCE selection buttons will be reactivated.

NOTE

To turn the internal oscillator on/off, adjust its level and make other settings for it, tap the  icon above and to the left of the OSC button and switch to the MONITOR SETUP (MONITOR/SOLO) Screen. (See “Making talkback and built-in oscillator settings” on page 62.)

5 – Routing

Setting input sources for multiple channels at the same time in blocks

1. When the LOCK/UNLOCK button (①) is set to “UNLOCK”, tap the 8ch BLOCK, 16ch BLOCK (Sonicview 16) or 24ch BLOCK (Sonicview 24) button on the MODULE (INPUT) Screen to open a window where multiple input sources can be set at the same time.

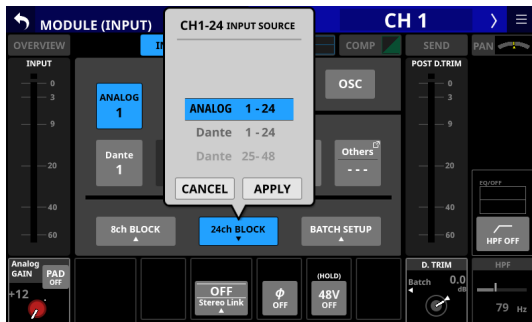
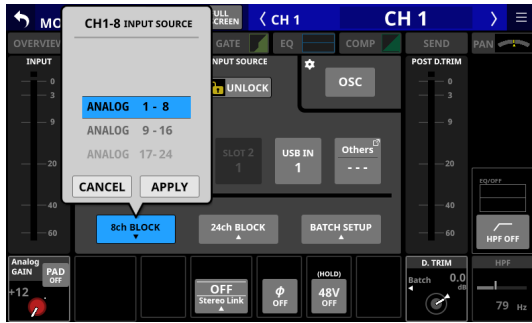

2. Swipe the options up and down to select the input sources. Selections can also be changed by turning LCD Knob 3 (for the 8ch BLOCK) or LCD knob 4 (for the 16ch/24ch BLOCK).
3. Tap the APPLY button to open a setting confirmation window.

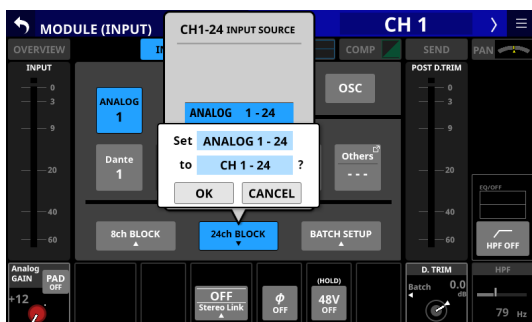
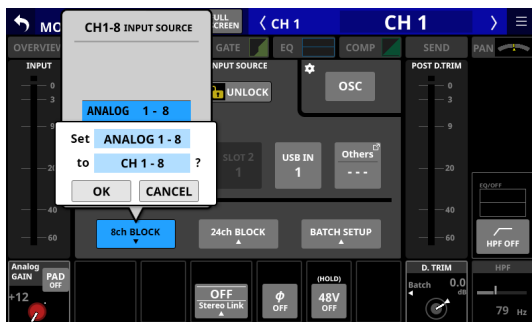

4. Tap the OK button to set multiple input sources at the same time. This will return to the MODULE (INPUT) Screen where the INPUT SOURCE selection button will show the selected input source.

NOTE

- When the LOCK/UNLOCK button is set to “LOCK”, the 8ch BLOCK, 16ch BLOCK and 24ch BLOCK buttons are disabled.
- If routing operation is set to “LOCK” on another touchscreen while a multiple setting window is open, it will close automatically.

Setting inputs sources for multiple channels at the same time in batches

1. When the LOCK/UNLOCK button (①) is set to “UNLOCK”, tap the BATCH SETUP button on the MODULE (INPUT) Screen to open a BATCH SETUP window where multiple input sources can be set at the same time.

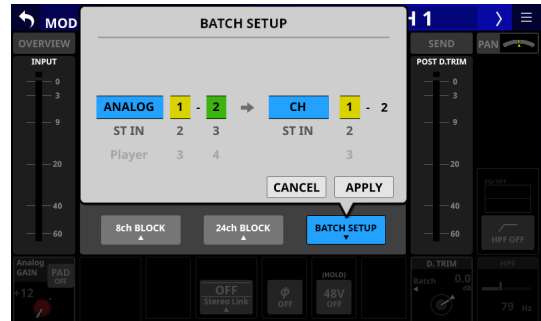

2. Swipe the options up and down to select the input sources and the modules they will be assigned to. Selections can also be changed by turning the LCD Knobs 2–6 with the same colors.
3. Tap the APPLY button to open a setting confirmation window.

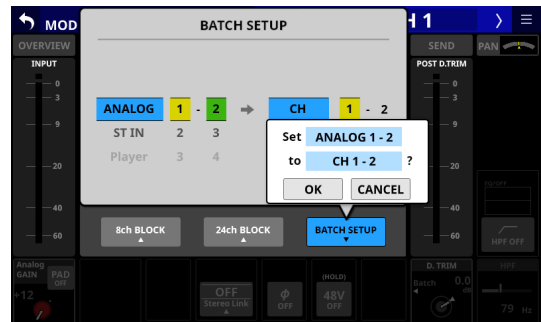

4. Tap the OK button to set multiple input sources at the same time. This will close the BATCH SETUP window, and the INPUT SOURCE selection button will show the selected input source.

NOTE

- When the LOCK/UNLOCK button is set to “LOCK”, the BATCH SETUP button is disabled.
- If routing operation is set to “LOCK” on another touchscreen while a multiple setting window is open, it will close automatically.

Direct out signal output routing

The CH 1–40 modules have direct out functions. Set direct out signal output routing on the MODULE (OVERVIEW) Screen for CH 1–40 modules. Tap the MODULE NAME area on the Home Screen to open this screen.

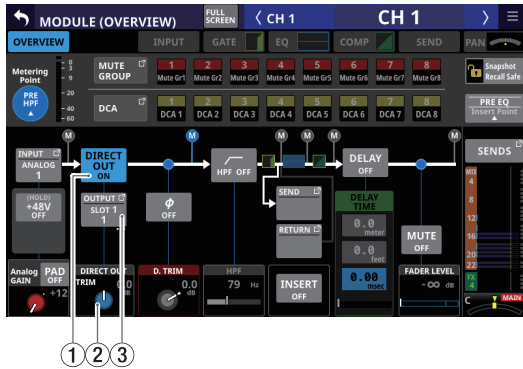

CH 1–40 modules

① DIRECT OUT button

Tap this button to turn DIRECT OUT ON (default) or OFF. When ON, the signal will be output directly from this point, and this button and the DIRECT OUT TRIM knob will be highlighted.

NOTE

The DIRECT OUT POINT for CH 1–40 modules can also be changed as explained in “CH 1–40 CONFIG page” on page 42.

② DIRECT OUT TRIM knob

Use this to adjust the DIRECT OUT output signal level.

Range: -20 dB – +20 dB (default: 0 dB)

Turn LCD knob 2/4/5/7 (lit blue) to adjust it.

NOTE

The knob used for this operation depends on DIRECT OUT POINT and DELAY POINT settings.

③ OUTPUT button

- This shows the name of the output port that the DIRECT OUT signal is assigned to. If it has been assigned to multiple output ports, “...” will appear to the bottom right of the button.
- If the module is stereo, output port names will appear split left and right and abbreviated as follows.

| Module name shown | Stereo module name shown |
|-------------------|--------------------------|
| ANALOG | AN |
| Dante | DA |
| SLOT 1 | S1 |
| SLOT 2 | S2 |
| USB OUT | USB |

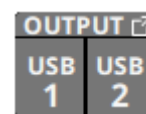

- If a Dante port that has a mounted SB-16D assigned is selected, “SB #[ID] [port number]” will be shown.



If it is a virtually-mounted SB-16D,  will appear.



- Tap this button to open the DIRECT OUT PORT SELECT Screen where DIRECT OUT output ports can be selected. (See “DIRECT OUT PORT SELECT screen” on page 108.)

5 – Routing

Insert input and output routing

The CH 1–40, MIX 1–22 and MAIN L/R Master modules have insert functions. Set insert input and output routing on the MODULE (OVERVIEW) Screen of these modules. Tap the MODULE NAME area on the Home Screen to open this screen.

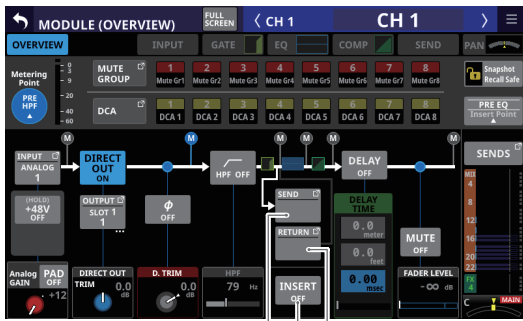

1 2 3
CH 1–40 modules

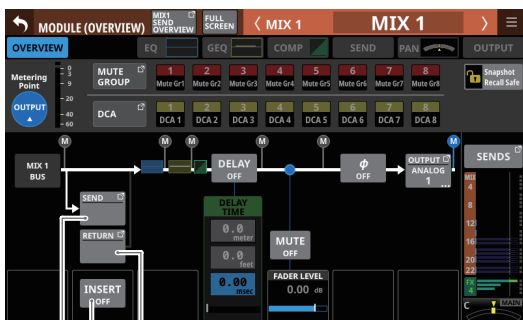

MIX 1–22 modules

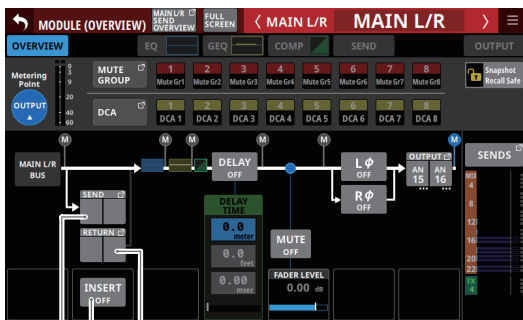

MAIN L/R Master module

1 SEND button

- This shows the name of the output port that the INSERT SEND signal is assigned to. If it has been assigned to multiple output ports, “...” will appear to the bottom right of the button.
- If the module is stereo, output port names will appear split left and right and abbreviated as follows.

| Module name shown | Stereo module name shown |
|-------------------|--------------------------|
| SLOT 1 | S1 |
| SLOT 2 | S2 |

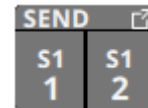

- Tap this button to open the INSERT SEND PORT SELECT Screen where INSERT SEND signal output ports can be selected. (See “INSERT SEND PORT SELECT screen” on page 110.)

2 INSERT button

Tap this button to turn INSERT ON or OFF.(default). When this is ON, the button will appear highlighted.

3 RETURN button

- This shows the name of the input port that is assigned for the INSERT RETURN signal.
- If the module is stereo, input port names will appear split left and right and abbreviated as follows.

| Module name shown | Stereo module name shown |
|-------------------|--------------------------|
| SLOT 1 | S1 |
| SLOT 2 | S2 |

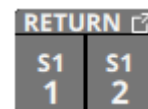

- Tap this button to open the INSERT RETURN PORT SELECT Screen where INSERT RETURN signal input ports can be selected. (See “INSERT RETURN PORT SELECT screen” on page 111.)

Output routing

Use the following screens for output routing.

MIX 1–22 and MAIN L/R Master MODULE (OVERVIEW) Screens

Tap the MODULE NAME area on the Home Screen to open this screen.

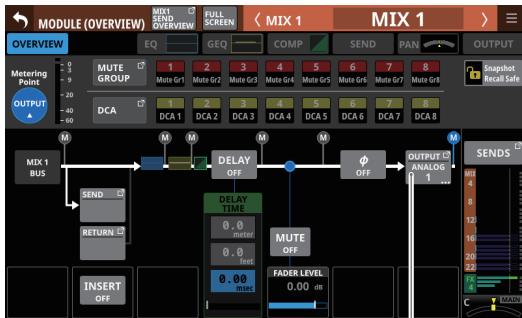

MIX 1–22 modules

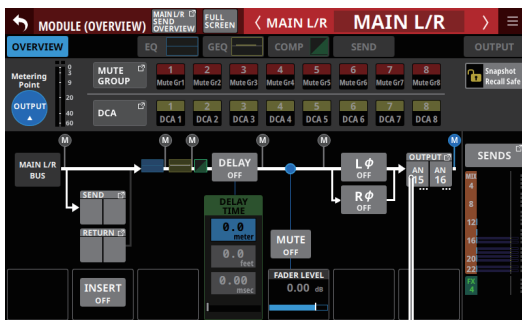

MAIN L/R Master module

① OUTPUT button

- This shows the name of the output port that the output signal of the selected module is assigned to. If it has been assigned to multiple output ports, "... " will appear to the bottom right of the button.
- If the module is stereo, output port names will appear split left and right and abbreviated as follows.

| Module name shown | Stereo module name shown |
|-------------------|--------------------------|
| ANALOG | AN |
| Dante | DA |
| SLOT 1 | S1 |
| SLOT 2 | S2 |
| USB OUT | USB |

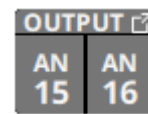

- If a Dante port that has a mounted SB-16D assigned is selected, "SB #[ID] [port number]" will be shown.

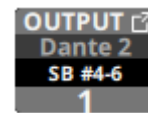

If it is a virtually-mounted SB-16D,  will appear.



- Tap this button to open the OUTPUT PORT SELECT Screen where output ports can be selected. (See "OUTPUT PORT SELECT screen" on page 112.)

5 – Routing

MIX 1–22 and MAIN L/R Master MODULE (OUTPUT) Screens

Tap the OUTPUT area at the top of the Home Screen of a MIX 1–22 or MAIN L/R Master module to open this screen.

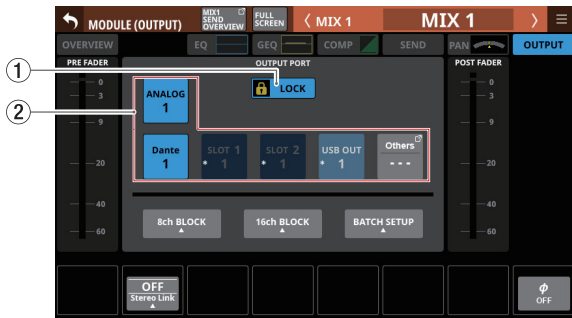

MIX 1–22 modules

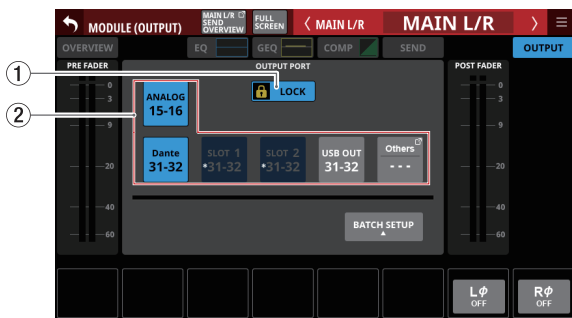

MAIN L/R Master module

① LOCK/UNLOCK button

- This button locks/unlocks routing setting change operations for the unit. This is always locked at the time of start up.
- When set to “LOCK”, tapping the OUTPUT PORT selection button (②) will not change settings. Furthermore, the 8ch BLOCK, 16ch BLOCK and BATCH SETUP buttons will also be disabled. However, tapping the Others button and switching to the OUTPUT PORT SELECT Screen is possible.
- When set to “LOCK”, tap this button to open a confirmation message. Tap the UNLOCK button to close the message and set it to “UNLOCK”. Tapping the CANCEL button on the confirmation message will close it and maintain the locked state.



- Tap this button when set to “UNLOCK” to switch it to “LOCK”.

NOTE

The LOCK/UNLOCK button (①) setting is shared by the following routing setting screens.

- MODULE (INPUT) Screen
- MODULE (OUTPUT) Screen
- INPUT SOURCE SELECT Screen
- OUTPUT PORT SELECT Screen
- DIRECT OUT PORT SELECT Screen
- INSERT SEND PORT SELECT Screen
- INSERT RETURN PORT SELECT Screen

② OUTPUT PORT selection buttons

- When the LOCK/UNLOCK button (①) is set to “UNLOCK”, tap signal output ports to select them for the selected module. The selected output port button will be highlighted light blue. If a selection button that already has another output signal assigned to it (shown by *) is tapped, a setting confirmation window will open. Tap the OK button to change the setting and close the window. Tap the CANCEL button to close the window without changing the setting.

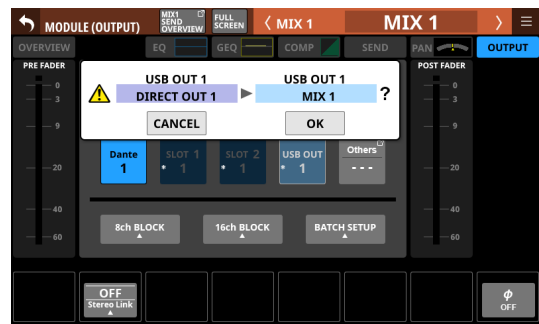

- If a Dante port that has a mounted SB-16D assigned is selected, “SB #[ID] [port number]” will be shown.

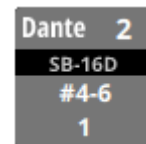

If it is a virtually-mounted SB-16D, (V) will appear.



- Assigned buttons for Dante ports that have virtually-mounted SB-16Ds will be highlighted yellow.



- If the selected output port is not shown elsewhere on this screen, the output port name will be shown on the Others button.
- If the module is stereo and output port that are not left-right adjacent are selected, output port names will appear split left and right and abbreviated as follows on the Others button.

| Module name shown | Stereo module name shown |
|-------------------|--------------------------|
| ANALOG | AN |
| Dante | DA |
| SLOT 1 | S1 |
| SLOT 2 | S2 |
| USB OUT | USB |



- Tap the Others button to open the OUTPUT PORT SELECT Screen where output ports not shown on this screen can be selected. (See “OUTPUT PORT SELECT screen” on page 112.)
- The signal from a single module can be assigned to multiple output ports.

NOTE

Output ports for multiple channels can also be set at the same time. (See “Setting output ports for multiple channels at the same time” on page 105 and “Setting output ports for multiple channels at the same time in batches” on page 106.)

Setting output ports for multiple channels at the same time

1. When the LOCK/UNLOCK button (①) is set to “UNLOCK”, tap the 8ch BLOCK or 16ch BLOCK button on the MODULE (OUTPUT) Screen to open a window where multiple output ports can be set at the same time.



2. Swipe the options up and down to select the output ports. Selections can also be changed by turning LCD Knob 3 (for the 8ch BLOCK) or LCD knob 4 (for the 16ch/24ch BLOCK).
3. Tap the APPLY button to open a setting confirmation window.

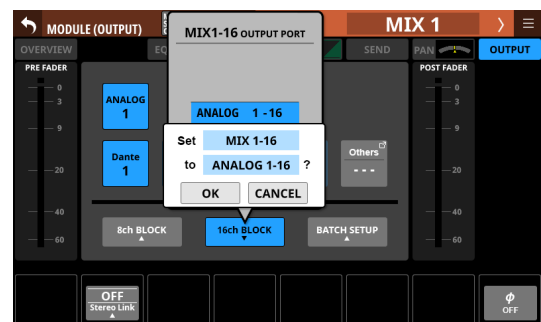
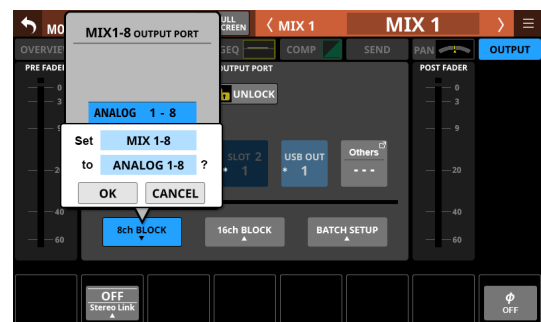

4. Tap the OK button to change multiple output ports at the same time. This will return to the MODULE (OUTPUT) Screen where the OUTPUT PORT selection button will show the selected output port.

NOTE

- When the LOCK/UNLOCK button is set to “LOCK”, the 8ch BLOCK and 16ch BLOCK buttons are disabled.
- If routing operation is set to “LOCK” on another touchscreen while a multiple setting window is open, it will close automatically.

5 – Routing

Setting output ports for multiple channels at the same time in batches

1. When the LOCK/UNLOCK button (①) is set to “UNLOCK”, tap the BATCH SETUP button on the MODULE (OUTPUT) Screen to open a BATCH SETUP window where multiple output ports can be set at the same time.

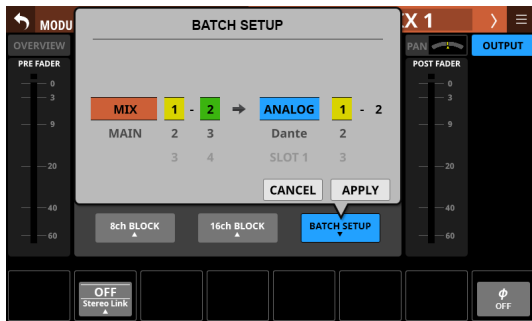

2. Swipe the options up and down to select the output ports. Selections can also be changed by turning the LCD Knobs 2–6 with the same colors.
3. Tap the APPLY button to open a setting confirmation window.

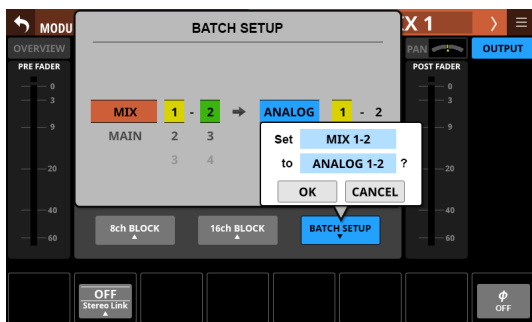

4. Tap the OK button to change multiple output ports at the same time. This will close the BATCH SETUP window, and the OUTPUT PORT selection button will show the selected output port.

NOTE

- When the LOCK/UNLOCK button is set to “LOCK”, the BATCH SETUP button is disabled.
- If routing operation is set to “LOCK” on another touchscreen while a multiple setting window is open, it will close automatically.

INPUT SOURCE SELECT screen

Select input sources for CH 1–40 and ST IN 1–2 modules on this screen.

Tap the INPUT button on the MODULE (OVERVIEW) Screen or the Others button on the MODULE (INPUT) Screen of these modules to open this screen. (See “Input routing” on page 98.)

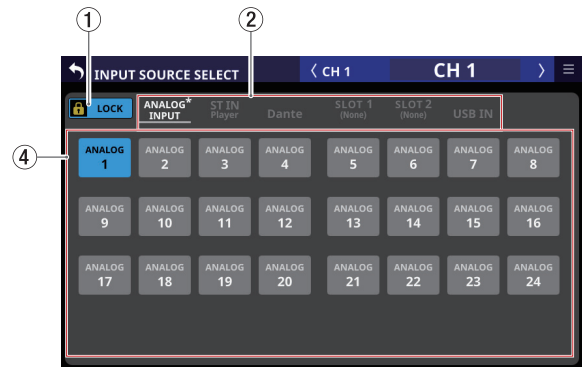

① LOCK/UNLOCK button

- This button locks/unlocks routing setting change operations for the unit. This is always locked at the time of start up.
- When set to “LOCK”, tapping the input source selection button (③) will not change settings.
- When set to “LOCK”, tap this button to open a confirmation message. Tap the UNLOCK button to close the message and set it to “UNLOCK”. Tapping the CANCEL button on the confirmation message will close it and maintain the locked state.



- Tap this button when set to “UNLOCK” to switch it to “LOCK”.

NOTE

The LOCK/UNLOCK button (①) setting is shared by the following routing setting screens.

- MODULE (INPUT) Screen
- MODULE (OUTPUT) Screen
- INPUT SOURCE SELECT Screen
- OUTPUT PORT SELECT Screen
- DIRECT OUT PORT SELECT Screen
- INSERT SEND PORT SELECT Screen
- INSERT RETURN PORT SELECT Screen

② Input source group page switches

- These show input source group page names.
- Tap a page name to switch to the page with the corresponding input source group. The name of the selected page will be highlighted. An * will appear next to the name of the page that the selected input source is on.

| Page name | Contents |
|-----------------|---|
| ANALOG INPUT | Select analog MIC/LINE input jacks on this page. |
| ST IN Player | Select the two pairs of ST IN jacks and the internal memory player. |
| Dante | Select the built-in Dante inputs. |
| SLOT 1 | Select the inputs of the expansion card installed in SLOT 1. |
| SLOT 2 | Select the inputs of the expansion card installed in SLOT 2. |
| USB IN | Select USB audio interface inputs. |

③ L/R selection buttons

These select whether to set the input ports of the left or right channels of stereo modules.

Tap these buttons to switch between left and right. The selected button will be highlighted.

④ Input source selection buttons

- When the LOCK/UNLOCK button (①) is set to “UNLOCK”, tap these buttons to select input sources. The selected button will be highlighted light blue. Buttons that cannot be used will appear dark gray. If a button that cannot be used is selected, it will appear dark blue.
- For stereo modules, “L” will be shown on the bottom left of the button selected for the left channel and “R” will be shown on the bottom right of the button selected for the right channel.
- If a Dante port that has a mounted SB-16D assigned is selected, “SB #[ID] [port number]” will be shown.



If it is a virtually-mounted SB-16D, (V) will appear.



- Assigned buttons for Dante ports that have virtually-mounted SB-16Ds will be highlighted yellow.



⑤ Scroll knob and scrollbar

These appear when all selectable options cannot be shown on the display at the same time.

Drag the display to scroll the screen. The screen can also be scrolled by swiping up and down on the input source selection button (②) area as well as by turning LCD knob 8.

5 – Routing

DIRECT OUT PORT SELECT screen

Select output ports for CH 1–40 module DIRECT OUT signals on this screen.

Tap the OUTPUT button above the DIRECT OUT TRIM knob on the MODULE (OVERVIEW) Screen for CH 1–40 modules to open this screen. (See “Direct out signal output routing” on page 101.)

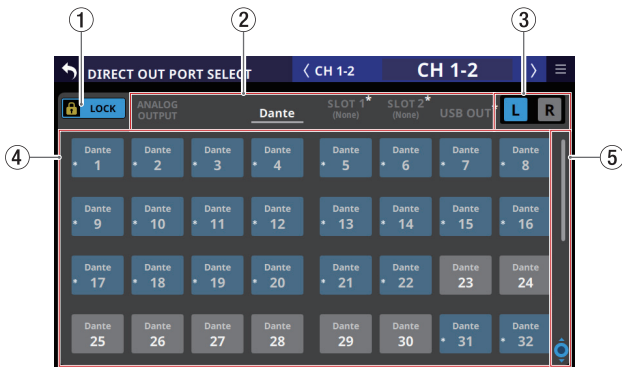
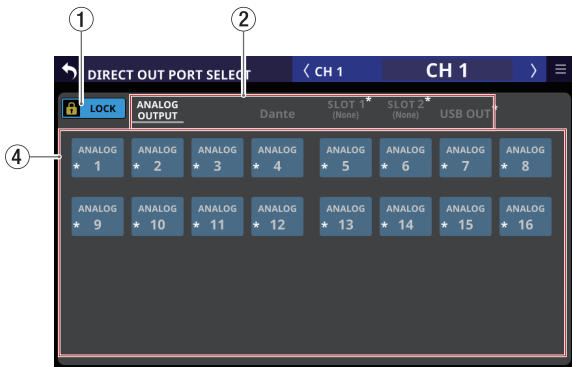

① LOCK/UNLOCK button

- This button locks/unlocks routing setting change operations for the unit. This is always locked at the time of start up.
- When set to “LOCK”, tapping an output port selection button (③) will not change the setting.
- When set to “LOCK”, tap this button to open a confirmation message. Tap the UNLOCK button to close the message and set it to “UNLOCK”. Tapping the CANCEL button on the confirmation message will close it and maintain the locked state.

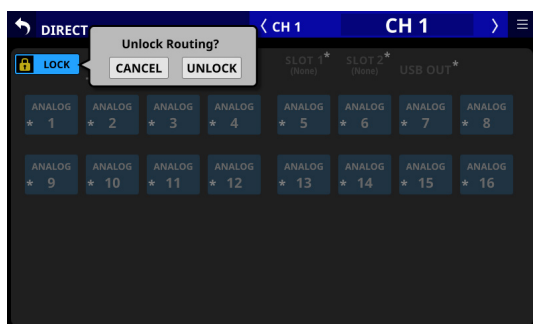

- Tap this button when set to “UNLOCK” to switch it to “LOCK”.

NOTE

The LOCK/UNLOCK button (①) setting is shared by the following routing setting screens.

- MODULE (INPUT) Screen
- MODULE (OUTPUT) Screen
- INPUT SOURCE SELECT Screen
- OUTPUT PORT SELECT Screen
- DIRECT OUT PORT SELECT Screen
- INSERT SEND PORT SELECT Screen
- INSERT RETURN PORT SELECT Screen

② Output port group page switches

- These show output port group page names.
- Tap a page name to switch to the page with the corresponding output port group. The name of the selected page will be highlighted. An * will appear next to the name of the page that the selected output port is on.

| Page name | Contents |
|---------------|--|
| ANALOG OUTPUT | Select analog output ports. |
| Dante | Select built-in Dante output ports. |
| SLOT 1 | Select the output ports of the expansion card installed in SLOT 1. |
| SLOT 2 | Select the output ports of the expansion card installed in SLOT 2. |
| USB OUT | Select USB audio interface output ports. |

③ L/R selection buttons

These select whether to set the output ports of the left or right channels of stereo modules.

Tap these buttons to switch between left and right. The selected button will be highlighted.

④ Output port selection buttons

- When the LOCK/UNLOCK button (①) is set to “UNLOCK”, tap these buttons to select output ports. The selected button will be highlighted light blue. Buttons that cannot be used will appear dark gray. If a button that cannot be used is selected, it will appear dark blue.
- For stereo modules, “L” will be shown to the bottom left of the button selected for the left channel and “R” will be shown to the bottom right of the button selected for the right channel.
- If a Dante port that has a mounted SB-16D assigned is selected, “SB #[ID] [port number]” will be shown.



If it is a virtually-mounted SB-16D, (V) will appear.

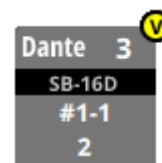

- Assigned buttons for Dante ports that have virtually-mounted SB-16Ds will be highlighted yellow.

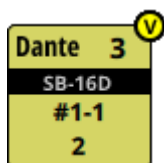

- An * will appear on the buttons of ports that are already assigned to other modules, and the buttons will appear grayish blue. Tap these buttons to open a setting confirmation window. Tap the OK button to change the setting and close the window. Tap the CANCEL button to close the window without changing the setting.

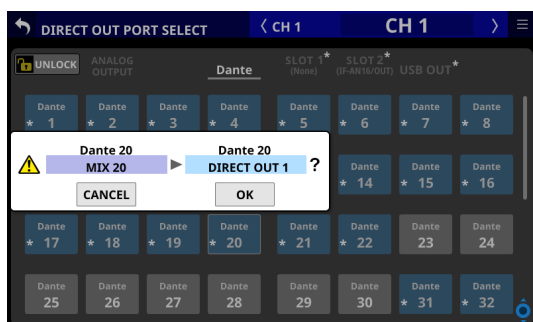

NOTE

The signal from a single module can be assigned to multiple output ports.

⑤ Scroll knob and scrollbar

These appear when all selectable options cannot be shown on the display at the same time.

Drag the display to scroll the screen. The screen can also be scrolled by swiping up and down on the output port selection button (④) area as well as by turning LCD knob 8.

5 – Routing

INSERT SEND PORT SELECT screen

Set INSERT SEND signal output ports for CH 1–40, MIX 1–22 and MAIN L/R Master modules on this screen.

Tap the SEND button on the MODULE (OVERVIEW) Screen of these modules to open this screen. (See “Insert input and output routing” on page 102.)



① LOCK/UNLOCK button

- This button locks/unlocks routing setting change operations for the unit. This is always locked at the time of start up.
- When set to “LOCK”, tapping an output port selection button (③) will not change the setting.
- When set to “LOCK”, tap this button to open a confirmation message. Tap the UNLOCK button to close the message and set it to “UNLOCK”. Tapping the CANCEL button on the confirmation message will close it and maintain the locked state.



- Tap this button when set to “UNLOCK” to switch it to “LOCK”.

NOTE

The LOCK/UNLOCK button (①) setting is shared by the following routing setting screens.

- MODULE (INPUT) Screen
- MODULE (OUTPUT) Screen
- INPUT SOURCE SELECT Screen
- OUTPUT PORT SELECT Screen
- DIRECT OUT PORT SELECT Screen
- INSERT SEND PORT SELECT Screen
- INSERT RETURN PORT SELECT Screen

② Output port group page switches

- These show output port group page names.
- Tap a page name to switch to the page with the corresponding output port group. The name of the selected page will be highlighted. An * will appear next to the name of the page that the selected output port is on.

| Page name | Contents |
|-----------|--|
| SLOT 1 | Select the output ports of the expansion card installed in SLOT 1. |
| SLOT 2 | Select the output ports of the expansion card installed in SLOT 2. |

③ L/R selection buttons

These select whether to set the output ports of the left or right channels of stereo modules.

Tap these buttons to switch between left and right. The selected button will be highlighted.

④ Output port selection buttons

- When the LOCK/UNLOCK button (①) is set to “UNLOCK”, tap these buttons to select output ports. The selected button will be highlighted light blue. Buttons that cannot be used will appear dark gray. If a button that cannot be used is selected, it will appear dark blue.
- For stereo modules, “L” will be shown to the bottom left of the button selected for the left channel and “R” will be shown to the bottom right of the button selected for the right channel.
- An * will appear on the buttons of ports that are already assigned to other modules, and the buttons will appear grayish blue. Tap these buttons to open a setting confirmation window. Tap the OK button to change the setting and close the window. Tap the CANCEL button to close the window without changing the setting.

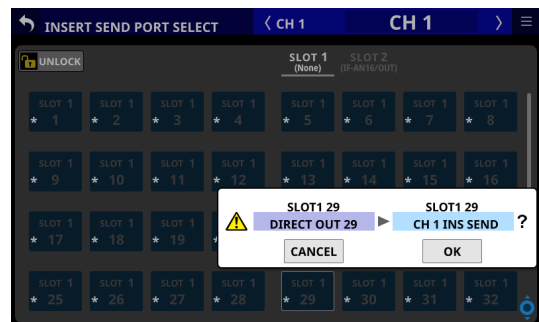

NOTE

The signal from a single module can be assigned to multiple output ports.

⑤ Scroll knob and scrollbar

These appear when all selectable options cannot be shown on the display at the same time.

Drag the display to scroll the screen. The screen can also be scrolled by swiping up and down on the output port selection button (③) area as well as by turning LCD knob 8.

INSERT RETURN PORT SELECT screen

Set INSERT RETURN signal input ports for CH 1–40, MIX 1–22 and MAIN L/R Master modules on this screen.

Tap the RETURN button on the MODULE (OVERVIEW) Screen of these modules to open this screen. (See “Insert input and output routing” on page 102.)

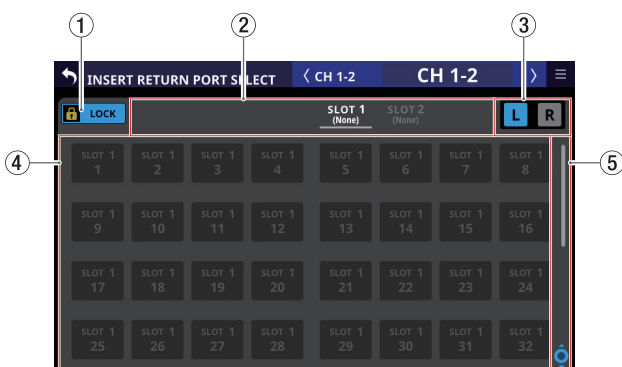
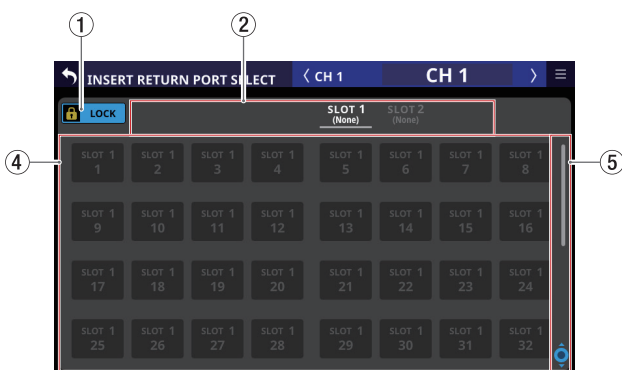

① LOCK/UNLOCK button

- This button locks/unlocks routing setting change operations for the unit. This is always locked at the time of start up.
- When set to “LOCK”, tapping the input source selection button (③) will not change settings.
- When set to “LOCK”, tap this button to open a confirmation message. Tap the UNLOCK button to close the message and set it to “UNLOCK”. Tapping the CANCEL button on the confirmation message will close it and maintain the locked state.

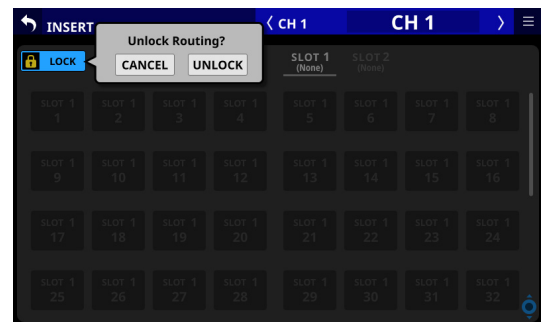

- Tap this button when set to “UNLOCK” to switch it to “LOCK”.

NOTE

The LOCK/UNLOCK button (①) setting is shared by the following routing setting screens.

- MODULE (INPUT) Screen
- MODULE (OUTPUT) Screen
- INPUT SOURCE SELECT Screen
- OUTPUT PORT SELECT Screen
- DIRECT OUT PORT SELECT Screen
- INSERT SEND PORT SELECT Screen
- INSERT RETURN PORT SELECT Screen

② Input source group page switches

- These show input source group page names.
- Tap a page name to switch to the page with the corresponding input source group. The name of the selected page will be highlighted. An * will appear next to the name of the page that the selected input source is on.

| Page name | Contents |
|-----------|--|
| SLOT 1 | Select the inputs of the expansion card installed in SLOT 1. |
| SLOT 2 | Select the inputs of the expansion card installed in SLOT 2. |

③ L/R selection buttons

These select whether to set the input ports of the left or right channels of stereo modules.

Tap these buttons to switch between left and right. The selected button will be highlighted.

④ Input source selection buttons

- When the LOCK/UNLOCK button (①) is set to “UNLOCK”, tap these buttons to select input sources. The selected button will be highlighted light blue. Buttons that cannot be used will appear dark gray. If a button that cannot be used is selected, it will appear dark blue.
- For stereo modules, “L” will be shown to the bottom left of the button selected for the left channel and “R” will be shown to the bottom right of the button selected for the right channel.

⑤ Scroll knob and scrollbar

These appear when all selectable options cannot be shown on the display at the same time.

Drag the display to scroll the screen. The screen can also be scrolled by swiping up and down on the input source selection button (③) area as well as by turning LCD knob 8.

5 – Routing

OUTPUT PORT SELECT screen

Set output ports for MIX 1–22 and MAIN L/R Master modules on this screen.

Tap the OUTPUT button on the MODULE (OVERVIEW) Screen or the Others button on the MODULE (OUTPUT) Screen of these modules to open this screen. (See “Output routing” on page 103.)

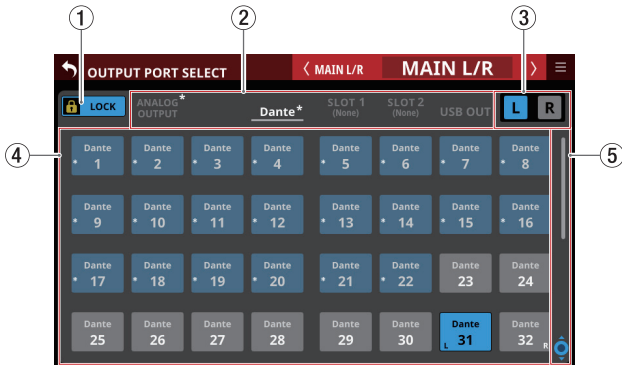
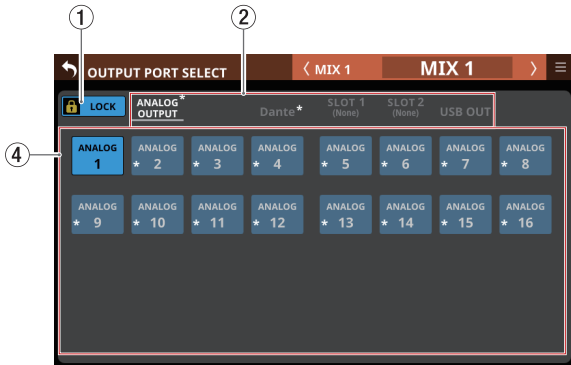

① LOCK/UNLOCK button

- This button locks/unlocks routing setting change operations for the unit. This is always locked at the time of start up.
- When set to “LOCK”, tapping an output port selection button (③) will not change the setting.
- When set to “LOCK”, tap this button to open a confirmation message. Tap the UNLOCK button to close the message and set it to “UNLOCK”. Tapping the CANCEL button on the confirmation message will close it and maintain the locked state.

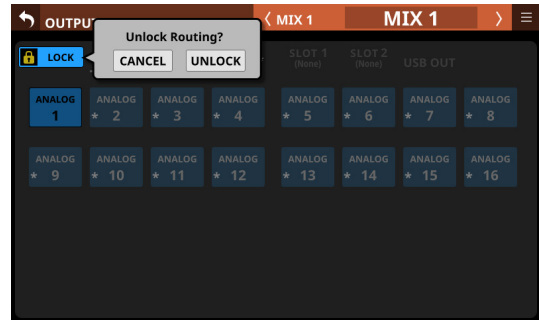

- Tap this button when set to “UNLOCK” to switch it to “LOCK”.

NOTE

The LOCK/UNLOCK button (①) setting is shared by the following routing setting screens.

- MODULE (INPUT) Screen
- MODULE (OUTPUT) Screen
- INPUT SOURCE SELECT Screen
- OUTPUT PORT SELECT Screen
- DIRECT OUT PORT SELECT Screen
- INSERT SEND PORT SELECT Screen
- INSERT RETURN PORT SELECT Screen

② Output port group page switches

- These show output port group page names.
- Tap a page name to switch to the page with the corresponding output port group. The name of the selected page will be highlighted. An * will appear next to the name of the page that the selected output port is on.

| Page name | Contents |
|---------------|--|
| ANALOG OUTPUT | Select analog output ports. |
| Dante | Select built-in Dante output ports. |
| SLOT 1 | Select the output ports of the expansion card installed in SLOT 1. |
| SLOT 2 | Select the output ports of the expansion card installed in SLOT 2. |
| USB OUT | Select USB audio interface output ports. |

③ L/R selection buttons

These select whether to set the output ports of the left or right channels of stereo modules.

Tap these buttons to switch between left and right. The selected button will be highlighted.

④ Output port selection buttons

- When the LOCK/UNLOCK button (①) is set to “UNLOCK”, tap these buttons to select output ports. The selected button will be highlighted light blue. Buttons that cannot be used will appear dark gray. If a button that cannot be used is selected, it will appear dark blue.
- For stereo modules, “L” will be shown to the bottom left of the button selected for the left channel and “R” will be shown to the bottom right of the button selected for the right channel.
- If a Dante port that has a mounted SB-16D assigned is selected, “SB #[ID] [port number]” will be shown.

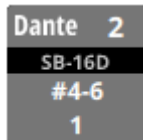

If it is a virtually-mounted SB-16D, **V** will appear.



- Assigned buttons for Dante ports that have virtually-mounted SB-16Ds will be highlighted yellow.

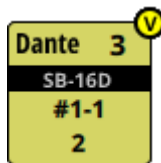

- An * will appear on the buttons of ports that are already assigned to other modules, and the buttons will appear grayish blue. Tap these buttons to open a setting confirmation window. Tap the OK button to change the setting and close the window. Tap the CANCEL button to close the window without changing the setting.

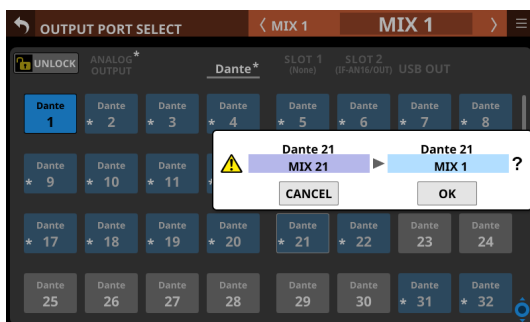

NOTE

The signal from a single module can be assigned to multiple output ports.

⑤ Scroll knob and scrollbar

These appear when all selectable options cannot be shown on the display at the same time.

Drag the display to scroll the screen. The screen can also be scrolled by swiping up and down on the output port selection button (④) area as well as by turning LCD knob 8.

6 – Modules

MODULE Screen

Use this screen to make settings for the selected module. Tap areas on the Home Screen or press the SEL key on the top panel to open a MODULE Screen.

MODULE Screen overview

Selection buttons for each page are shown at the top of the MODULE Screen.

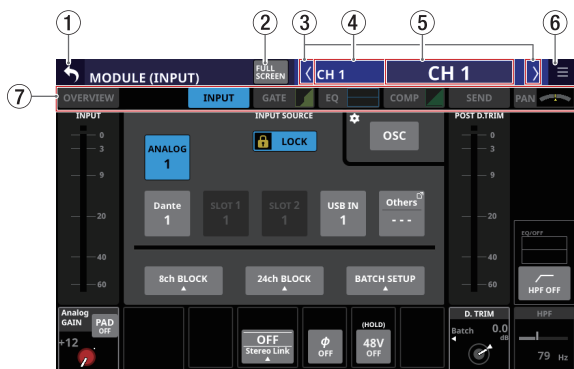

MODULE (INPUT) Screen for CH 1–40 modules



MODULE (EQ) Screen for MIX 1–22 modules

NOTE

- If the selected module is stereo, a stereo level meter will be shown.
- Each level meter has an overload indicator at its top. They will appear to light red when the signal level reaches or exceeds -0.00026 dBFS (16-bit full-scale value).
- When a level overload occurs, the entire bar meter will light red.
- The area below -60 dBFS at the bottom of the level meters will light when above -70 dBFS.

① button

Tap this button to return to the Home Screen.

② button

Tap this button to switch between showing the selected module normally or in full-screen mode, which expands the MODULE Screen to fill the entire touchscreen. When this is on, the button will appear highlighted.



In full-screen mode, it is easy to use all the touchscreens at the same time to adjust, for example, EQ and COMP, or GATE, EQ and COMP.

Turning this button off on one screen will reopen the Home Screen on the other touchscreens.

③ buttons

Tap these buttons to move left and right in order on the layer between modules to show and activate different ones for operation.

When the FULL SCREEN button is off, this will move only between the modules on the current page. For example, moving left and right on the COMP page will move only between the CH 1–40, MIX 1–22 and MAIN L/R Master modules on it.

When the FULL SCREEN button is on, pages become as follows after movement.

- If the module after movement is in the same category, the selected page will not change.
- If the module after movement is in a different category, it will be shown with the page shown previously in that category.

④ **Module name**

This shows the module name.

⑤ **User module name**

- This shows the user module name. If the user module name has not been defined, the module name will be shown as “CH 1” or “MIX 1”, for example.
- Tap this area to open the MODULE NAME Screen where the user module name and set module color can be changed. (See “MODULE NAME screen” on page 166.)

⑥ button

Tap this button to open the MODULE menu for the selected module.

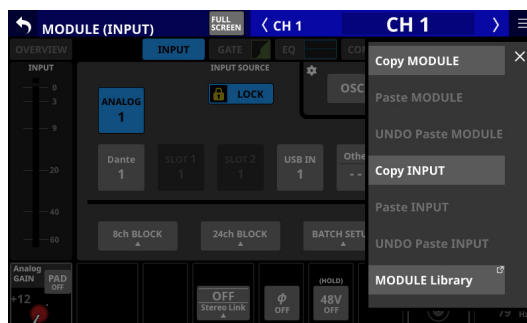

Tap menu items to, for example, change parameter settings for the selected module. (See “MODULE menu” on page 150.)

⑦ Page selection buttons

Tap a page selection button to open that page.
The selected button will be highlighted.

| Button | Use |
|----------------------------|--|
| OVERVIEW | Make overall settings for the selected module. |
| INPUT | Make input settings for the selected module. |
| FX | Make internal effect settings for the selected module. |
| GATE/EXPANDER/ DE-ESSER | Make dynamics effect settings for the selected module. |
| EQ | Make EQ settings for the selected module. |
| GEQ | Make GEQ settings for the selected module. |
| COMP/DUCKER | Make dynamics effect settings for the selected module. |
| SEND | Make bus send settings for the selected module. |
| PAN | Make pan settings for the selected module. |
| OUTPUT | Make output settings for the selected module. |

NOTE

- The INPUT button is only shown for CH 1–40 and ST IN 1–2 modules.
- The FX button is only shown for FX RTN 1–4 modules.
- The GATE, EXPANDER and DE-ESSER buttons are only shown for CH 1–40 modules.
- The GEQ button is only shown for MIX 1–22 and MAIN L/R Master modules.
- The COMP and DUCKER buttons are only shown for CH 1–40, MIX 1–22 and MAIN L/R master modules.
- The OUTPUT button is only shown for MIX 1–22 and MAIN L/R master modules.

6 – Modules

MODULE (OVERVIEW) Screen

Make overall modules settings on the MODULE (OVERVIEW) Screen, which every module has.

On this screen, signal processing flows from left to right, and the settings for the functions of the modules are shown.

Tap the MODULE NAME area on the Home Screen to open this screen.

CH 1–40 MODULE (OVERVIEW) Screens

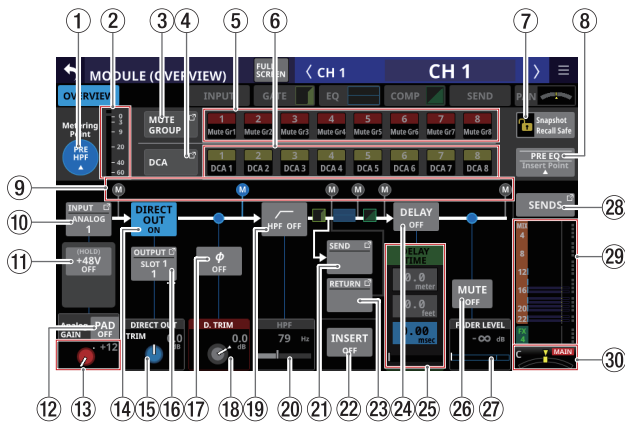

CH 1–40 modules when the stereo link setting is off

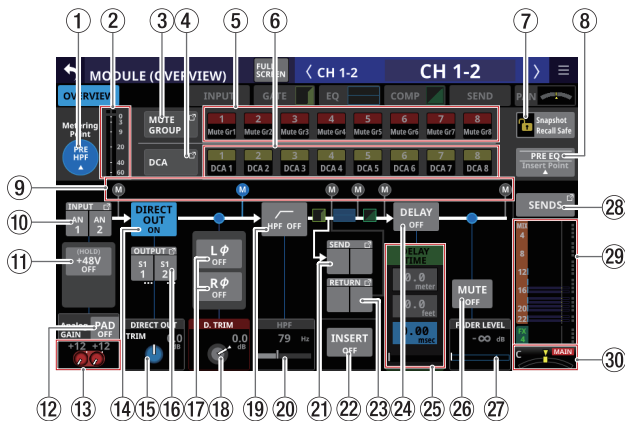

CH 1–40 modules when the stereo link setting is on

① Metering Point button

- This shows the name of the set metering point.
- Tap this button to open a window for setting metering points for CH 1–40 modules.

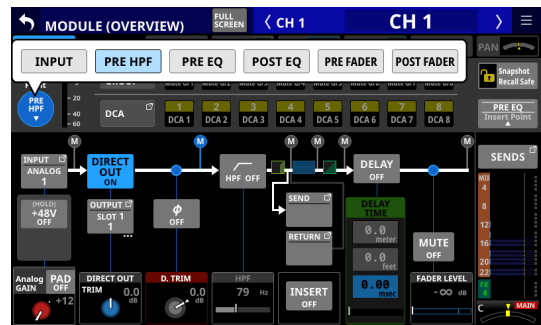

Options: INPUT, PRE HPF (default), PRE EQ, POST EQ, PRE FADER, POST FADER

Tap an option to switch the metering point for the level meter.

NOTE

Metering points can also be changed on the METERING POINT page of the METER SETUP Screen. (See “METERING POINT page” on page 40.)

② Level meters

This shows the level of the signal at the set metering point.

③ MUTE GROUP button

Tap this button to open the DCA/Mute Group SETUP Screen Mute Group Assign page. (See “Mute Group Assign page” on page 164.)

④ DCA button

Tap this button to open the DCA/Mute Group SETUP Screen DCA Assign page. (See “DCA Assign page” on page 163.)

⑤ MUTE GROUP 1–8 buttons

Tap these buttons to change Mute Group assignment states. (Default: off)

Assigned buttons will be highlighted.

⑥ DCA 1–8 buttons

Tap these buttons to change DCA assignment states. (Default: off)

Assigned buttons will be highlighted.

⑦ Snapshot Recall Safe button

Tap this button to enable the Snapshot Recall Safe function for the selected module. (Default: off)

When this is on, the button will appear highlighted.

NOTE

This can also be set on the MODULE SAFE page of the SNAPSHOT RECALL SAFE Screen. (See “MODULE SAFE page” on page 178.)

⑧ Insert Point

- This shows the name of the set insert point.
- Tap this button to open a window for setting the insert point for the selected module.

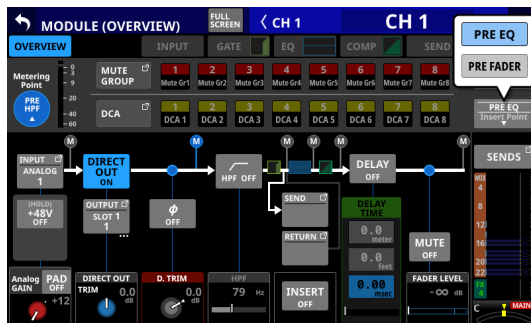

Options: PRE EQ (default), PRE FADER

NOTE

Insert point settings can be made for CH 1–40 all at once using INSERT POINT BATCH SETUP on the MIXER CONFIG (CH1-40 CONFIG) Screen. (See “CH 1–40 CONFIG page” on page 42.)

⑨ Metering Point position indicator

The highlighted indicator shows the position of the set metering point.

⑩ INPUT button

- This shows the input source name.
- If the module is stereo, input source names will appear split left and right and abbreviated as follows.

| Module name shown | Stereo module name shown |
|-------------------|--------------------------|
| ANALOG | AN |
| Dante | DA |
| SLOT 1 | S1 |
| SLOT 2 | S2 |
| USB IN | USB |
| ST IN 1 | ST1 |
| ST IN 2 | ST2 |
| PLAYER | PL |

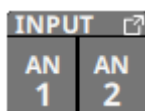

- If a Dante port that has a mounted SB-16D assigned is selected, “SB #[ID] [port number]” will be shown.



If it is a virtually-mounted SB-16D, will appear.



- Tap this button to open the INPUT SOURCE SELECT Screen. (See “INPUT SOURCE SELECT screen” on page 106.)

⑪ +48V button

- This shows the +48V button when the input source of the selected module is “ANALOG” or “SB-16D connected by built-in Dante”.
If the selected module is a stereo module and the input sources for both the left and right channels are “ANALOG” or “SB-16D connected by built-in Dante”, this shows the left channel setting.
- Touch and hold the +48V button to turn phantom power (+48V) on/off. (Default: off)
If the selected module is a stereo module and the input sources for both the left and right channels are “ANALOG” or “SB-16D connected by built-in Dante”, this switches phantom power on/off for both channels.
When phantom power is on, the button will be highlighted.
- A black button that cannot be operated will be shown if the input source is an SB-16D for which control privileges are not held.

⑫ PAD button

- This shows the PAD button when the input source of the selected module is “ANALOG” or “SB-16D connected by built-in Dante”.
If the selected module is a stereo module and the input sources for both the left and right channels are “ANALOG” or “SB-16D connected by built-in Dante”, this shows the left channel setting.
- Tap this button to turn the -20dB pad on/off. (Default: off)
If the selected module is a stereo module and the input sources for both the left and right channels are “ANALOG” or “SB-16D connected by built-in Dante”, this switches the -20dB pad on/off for both channels.
When this button is on, it will appear highlighted.
- A black button that cannot be operated will be shown if the input source is an SB-16D for which control privileges are not held.

NOTE

When the pad is switched on/off, the Analog GAIN value will be controlled as shown below so that it changes as little as possible.

When Analog Reference Level is +6 dBU and Digital Reference Level is -9 dBFS

| Status before switching pad setting | Analog GAIN after switching pad setting |
|-------------------------------------|---|
| Analog GAIN: +3 – +37 | Same value |
| PAD ON/Analog GAIN: -17 – +2 | +3 |
| PAD OFF/Analog GAIN: +38 – +57 | +37 |

When Analog Reference Level is +4 dBU and Digital Reference Level is -20 dBFS

| Status before switching pad setting | Analog GAIN after switching pad setting |
|-------------------------------------|---|
| Analog GAIN: +12 – +46 | Same value |
| PAD ON/Analog GAIN: -8 – +11 | +12 |
| PAD OFF/Analog GAIN: +47 – +66 | +46 |

6 – Modules

When Analog Reference Level is +4 dBu and Digital Reference Level is -18 dBFS

| Status before switching pad setting | Analog GAIN after switching pad setting |
|-------------------------------------|---|
| Analog GAIN: +10 – +44 | Same value |
| PAD ON/Analog GAIN: -10 – +9 | +10 |
| PAD OFF/Analog GAIN: +45 – +64 | +44 |

When Analog Reference Level is +4 dBu and Digital Reference Level is -16 dBFS

| Status before switching pad setting | Analog GAIN after switching pad setting |
|-------------------------------------|---|
| Analog GAIN: +8 – +42 | Same value |
| PAD ON/Analog GAIN: -12 – +7 | +8 |
| PAD OFF/Analog GAIN: +43 – +62 | +42 |

When Analog Reference Level is +4 dBu and Digital Reference Level is -14 dBFS

| Status before switching pad setting | Analog GAIN after switching pad setting |
|-------------------------------------|---|
| Analog GAIN: +6 – +40 | Same value |
| PAD ON/Analog GAIN: -14 – +5 | +6 |
| PAD OFF/Analog GAIN: +41 – +60 | +40 |

When Analog Reference Level is 0 dBu and Digital Reference Level is -20 dBFS

| Status before switching pad setting | Analog GAIN after switching pad setting |
|-------------------------------------|---|
| Analog GAIN: +8 – +42 | Same value |
| PAD ON/Analog GAIN: -12 – +7 | +8 |
| PAD OFF/Analog GAIN: +43 – +62 | +42 |

When Analog Reference Level is 0 dBu and Digital Reference Level is -18 dBFS

| Status before switching pad setting | Analog GAIN after switching pad setting |
|-------------------------------------|---|
| Analog GAIN: +6 – +40 | Same value |
| PAD ON/Analog GAIN: -14 – +5 | +6 |
| PAD OFF/Analog GAIN: +41 – +60 | +40 |

13 Analog GAIN knob

- When the input source of the selected module is "ANALOG" or "SB-16D connected by built-in Dante", an analog gain knob will be shown for this unit or the SB-16D that can be used to adjust the input level of the MIC/LINE input jack.
Turn LCD knob 1 (lit red) to adjust it.

When Analog Reference Level is +6 dBu and Digital Reference Level is -9 dBFS

| PAD button setting | Range |
|--------------------|--------------------|
| OFF | +3 (default) – +57 |
| ON | -17 – +37 |

When Analog Reference Level is +4 dBu and Digital Reference Level is -20 dBFS

| PAD button setting | Range |
|--------------------|---------------------|
| OFF | +12 (default) – +66 |
| ON | -8 – +46 |

When Analog Reference Level is +4 dBu and Digital Reference Level is -18 dBFS

| PAD button setting | Range |
|--------------------|---------------------|
| OFF | +10 (default) – +64 |
| ON | -10 – +44 |

When Analog Reference Level is +4 dBu and Digital Reference Level is -16 dBFS

| PAD button setting | Range |
|--------------------|--------------------|
| OFF | +8 (default) – +62 |
| ON | -12 – +42 |

When Analog Reference Level is +4 dBu and Digital Reference Level is -14 dBFS

| PAD button setting | Range |
|--------------------|--------------------|
| OFF | +6 (default) – +60 |
| ON | -14 – +40 |

When Analog Reference Level is 0 dBu and Digital Reference Level is -20 dBFS

| PAD button setting | Range |
|--------------------|--------------------|
| OFF | +8 (default) – +62 |
| ON | -12 – +42 |

When Analog Reference Level is 0 dBu and Digital Reference Level is -18 dBFS

| PAD button setting | Range |
|--------------------|--------------------|
| OFF | +6 (default) – +60 |
| ON | -14 – +40 |

- The indicators to the left of the Analog GAIN knobs appear to light as shown below depending on the input level.
Red: -3 dBFS, Green: -40 dBFS
- When the input source of the selected module is "ANALOG" or "SB-16D connected by built-in Dante" and the Stereo Link setting is on, 2 Analog GAIN knobs will be shown for the linked channels.
Turn LCD knob 1 (lit red) to adjust both together.
To operate them separately, turn the GANG function OFF on the MODULE (INPUT) screen.
- A black knob that cannot be operated will be shown if the input source is an SB-16D for which control privileges are not held.

NOTE

Explanation of Analog GAIN values

When signals at the Analog Reference Level (+6 dBu, +4 dBu, 0 dBu) are input, the Analog GAIN value that becomes the Digital Reference Level (-9 dBFS, -14 dBFS, -16 dBFS, -18 dBFS, -20 dBFS) at the digital stage is shown as "0".

14 DIRECT OUT button

Tap this button to turn DIRECT OUT on/off. (Default: ON)
When ON, the signal will be output directly from this point, and this button and the DIRECT OUT TRIM knob will be highlighted.

NOTE

The DIRECT OUT POINT for CH 1–40 modules can also be changed as explained in “CH 1–40 CONFIG page” on page 42.

15 DIRECT OUT TRIM knob

Use this to adjust the DIRECT OUT output signal level.

Range: -20 dB – +20 dB (default: 0 dB)

Turn LCD knob 2/4/5/7 (lit blue) to adjust it.

NOTE

The knob used for this operation depends on DIRECT OUT POINT and DELAY POINT settings (“CH 1–40 CONFIG page” on page 42).

16 OUTPUT button

- This shows the name of the output port that the DIRECT OUT signal is assigned to. If it has been assigned to multiple output ports, “...” will appear to the bottom right of the button.
- If the module is stereo, output port names will appear split left and right and abbreviated as follows.

| Module name shown | Stereo module name shown |
|-------------------|--------------------------|
| ANALOG | AN |
| Dante | DA |
| SLOT 1 | S1 |
| SLOT 2 | S2 |
| USB OUT | USB |

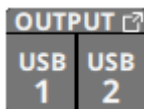

- If a Dante port that has a mounted SB-16D assigned is selected, “SB #[ID] [port number]” will be shown.



If it is a virtually-mounted SB-16D,  will appear.





- Tap this button to open the DIRECT OUT SELECT Screen. (See “DIRECT OUT PORT SELECT screen” on page 108.)

17 Phase buttons





Use these to change the phases of the signals for the selected module.

Tap these buttons to reverse the phases of the selected module signals.

- Phase button display when the Stereo Link setting is off for the selected module

| | |
|---|----------|
|  | Normal |
|  | Reversed |

- Phase button display when the selected module is stereo

| | | |
|---|--|----------|
|  |  | Normal |
|  |  | Reversed |

18 D.TRIM knob

Use this to adjust the digital trim value.

Range: -50.0 dB – +20.0 dB (default: 0.0 dB)

Turn LCD knob 2/3/4 (lit red) to adjust it.

NOTE

The knob used for this operation depends on DIRECT OUT POINT and DELAY POINT settings (“CH 1–40 CONFIG page” on page 42).

19 HPF button

Tap this button to turn the HPF on/off. (Default: OFF)
When this is ON, the button will appear highlighted.

20 HPF frequency

This adjusts the cutoff frequency of the HPF.

Range: 20 Hz – 1.0 kHz (default: 79 Hz)

Turn LCD knob 3/4/5 (lit blue) to adjust it.

When this is on, it will appear highlighted.

NOTE

The knob used for this operation depends on DIRECT OUT POINT and DELAY POINT settings (“CH 1–40 CONFIG page” on page 42).

6 – Modules

21 SEND button

- This shows the name of the output port that the INSERT SEND signal is assigned to. If it has been assigned to multiple output ports, “...” will appear to the bottom right of the button.
- If the module is stereo, output port names will appear split left and right and abbreviated as follows.

| Module name shown | Stereo module name shown |
|-------------------|--------------------------|
| SLOT 1 | S1 |
| SLOT 2 | S2 |

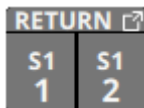

- Tap this button to open the INSERT SEND PORT SELECT Screen. (See “INSERT SEND PORT SELECT screen” on page 110.)

22 INSERT button

Tap this button to turn the INSERT on/off. (Default: OFF) When this is on, the button will appear highlighted.

23 RETURN button

- This shows the name of the input port that is assigned for the INSERT RETURN signal.
- If the module is stereo, input port names will appear split left and right and abbreviated as follows.

| Module name shown | Stereo module name shown |
|-------------------|--------------------------|
| SLOT 1 | S1 |
| SLOT 2 | S2 |

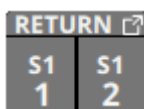

- Tap this button to open the INSERT RETURN PORT SELECT Screen. (See “INSERT RETURN PORT SELECT screen” on page 111.)

24 DELAY button

Tap this button to turn on/off the DELAY function, which corrects for input signal latency. (Default: OFF) When this is on, the button will appear highlighted.

25 DELAY TIME

This adjusts the DELAY TIME. The highlighted unit will be used for operation, so tap the button for the desired unit.

| Unit options | Range (unit) |
|----------------|-------------------|
| meter | 0 – 117.3 (meter) |
| feet | 0 – 384.8 (feet) |
| msec (default) | 0 – 341.32 (msec) |

Turn LCD knob 2/3/5/6 (lit green) to adjust it.

NOTE

- The DELAY POINT for CH 1–40 modules can also be changed as explained in “CH 1–40 CONFIG page” on page 42.
- The knob used for this operation depends on DIRECT OUT

POINT and DELAY POINT settings (“CH 1–40 CONFIG page” on page 42).

26 MUTE button

Tap this button to turn muting on/off for the selected module signal.

When MUTE is on, the button will be highlighted.

NOTE

The MUTE keys on the top of the unit can also be used to set this.

27 FADER LEVEL

Use this to adjust the FADER level of the selected module signal.

Range: $-\infty$ dB – +10.0 dB (default: $-\infty$ dB)

Turn LCD knob 6/7 (lit blue) to adjust it.

NOTE

- The channel faders on top of the unit can also be used for this adjustment.
- The knob number used for this operation depends on DIRECT OUT POINT setting (“CH 1–40 CONFIG page” on page 42).
- Tap the area while pressing the HOME key on the top panel to set the FADER level to 0 dB.

28 SENDS button

Tap this button to open the MODULE (SEND/PAN) Screen for the selected module. (See “MODULE (SEND/PAN) Screen” on page 144.)

29 MIX/FX SEND levels

- This list shows the on/off and PRE/POST states and the send levels to the MIX 1–22 and FX 1–4 buses. (See “10 ALL SEND button (ALL SEND)” on page 20.)
- Tap this area to open the MODULE (SEND/PAN) Screen for the selected module with the bus selected for the tapped area.

30 PAN/BAL

- This adjusts the panning/balance of the signals sent to the MAIN L/R bus. Turn LCD knob 8 (lit yellow) to adjust it. Range: L100 – C – R100 (default: C)
- When the **MAIN** icon is highlighted (**MAIN**), signals are being sent to the MAIN L/R bus.
- Tap this area to open the MODULE (SEND/PAN) Screen for the selected module. (See “MODULE (SEND/PAN) Screen” on page 144.)

NOTE

Tap this area while pressing the HOME key on the top panel to set panning/balance to center (C).

ST IN 1–2 MODULE (OVERVIEW) Screens

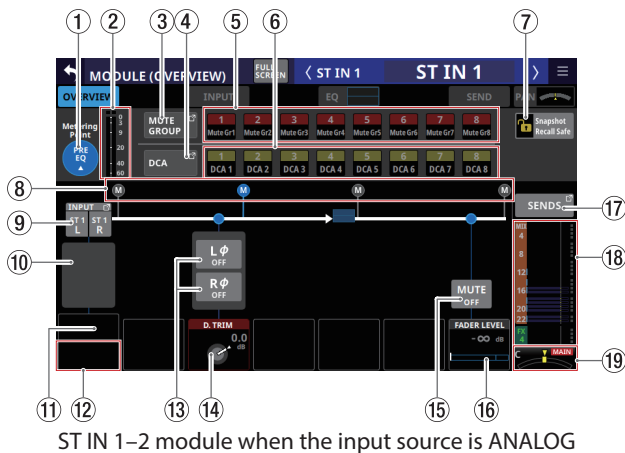

① Metering Point button

- This shows the name of the set metering point.
- Tap this button to open a window for setting metering points for ST IN 1–2 modules.

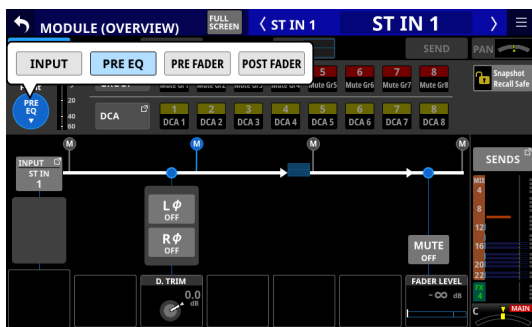

Options: INPUT, PRE EQ (default), PRE FADER, POST FADER

Tap an option to switch the metering point for the level meter.

NOTE

Metering points can also be changed on the METERING POINT page of the METER SETUP Screen. (See “METERING POINT page” on page 40.)

② Level meters

This shows the level of the signal at the set metering point.

③ MUTE GROUP button

Tap this button to open the DCA/Mute Group SETUP Screen Mute Group Assign page. (See “Mute Group Assign page” on page 164.)

④ DCA button

Tap this button to open the DCA/Mute Group SETUP Screen DCA Assign page. (See “DCA Assign page” on page 163.)

⑤ MUTE GROUP 1–8 buttons

Tap these buttons to change Mute Group assignment states. (Default: off)
Assigned buttons will be highlighted.

⑥ DCA 1–8 buttons

Tap these buttons to change DCA assignment states. (Default: off)
Assigned buttons will be highlighted.

⑦ Snapshot Recall Safe button

Tap this button to enable the Snapshot Recall Safe function for the selected module. (Default: off)
When this is on, the button will appear highlighted.

NOTE

This can also be set on the MODULE SAFE page of the SNAPSHOT RECALL SAFE Screen. (See “MODULE SAFE page” on page 178.)

⑧ Metering Point position indicator

The highlighted indicator shows the position of the set metering point.

⑨ INPUT button

- This shows the input source name. In this case, input source names will appear split left and right and abbreviated as follows.

| Module name shown | Stereo module name shown |
|-------------------|--------------------------|
| ANALOG | AN |
| Dante | DA |
| SLOT 1 | S1 |
| SLOT 2 | S2 |
| USB IN | USB |
| ST IN 1 | ST1 |
| ST IN 2 | ST2 |
| PLAYER | PL |

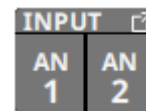

- If a Dante port that has a mounted SB-16D assigned is selected, “SB #[ID] [port number]” will be shown.

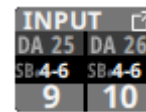

If it is a virtually-mounted SB-16D,  will appear.

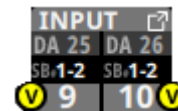

- Tap this button to open the INPUT SOURCE SELECT Screen. (See “INPUT SOURCE SELECT screen” on page 106.)

6 – Modules

⑩ +48V button

- This shows the +48V button when the input source of the selected module is “ANALOG” or “SB-16D connected by built-in Dante”.

If the input sources of the selected module for both the left and right channels are “ANALOG” or “SB-16D connected by built-in Dante”, this shows the left channel setting.

- Touch and hold the +48V button to turn phantom power (+48V) on/off. (Default: off)

If the input sources of the selected module for both the left and right channels are “ANALOG” or “SB-16D connected by built-in Dante”, this switches phantom power on/off for both channels.

When phantom power is on, the button will be highlighted.

- A black button that cannot be operated will be shown if the input source is an SB-16D for which control privileges are not held.

⑪ PAD button

- This shows the PAD button when the input source of the selected module is “ANALOG” or “SB-16D connected by built-in Dante”.

If the input sources of the selected module for both the left and right channels are “ANALOG” or “SB-16D connected by built-in Dante”, this shows the left channel setting.

- Tap this button to turn the -20dB pad on/off. (Default: off)

If the input sources of the selected module for both the left and right channels are “ANALOG” or “SB-16D connected by built-in Dante”, this switches the -20dB pad on/off for both channels.

When this button is on, it will appear highlighted.

- A black button that cannot be operated will be shown if the input source is an SB-16D for which control privileges are not held.

NOTE

When the pad is switched on/off, the Analog GAIN value will be controlled as shown below so that it changes as little as possible.

When Analog Reference Level is +6 dBu and Digital Reference Level is -9 dBFS

| Status before switching pad setting | Analog GAIN after switching pad setting |
|-------------------------------------|---|
| Analog GAIN: +3 – +37 | Same value |
| PAD ON/Analog GAIN: -17 – +2 | +3 |
| PAD OFF/Analog GAIN: +38 – +57 | +37 |

When Analog Reference Level is +4 dBu and Digital Reference Level is -20 dBFS

| Status before switching pad setting | Analog GAIN after switching pad setting |
|-------------------------------------|---|
| Analog GAIN: +12 – +46 | Same value |
| PAD ON/Analog GAIN: -8 – +11 | +12 |
| PAD OFF/Analog GAIN: +47 – +66 | +46 |

When Analog Reference Level is +4 dBu and Digital Reference Level is -18 dBFS

| Status before switching pad setting | Analog GAIN after switching pad setting |
|-------------------------------------|---|
| Analog GAIN: +10 – +44 | Same value |
| PAD ON/Analog GAIN: -10 – +9 | +10 |
| PAD OFF/Analog GAIN: +45 – +64 | +44 |

When Analog Reference Level is +4 dBu and Digital Reference Level is -16 dBFS

| Status before switching pad setting | Analog GAIN after switching pad setting |
|-------------------------------------|---|
| Analog GAIN: +8 – +42 | Same value |
| PAD ON/Analog GAIN: -12 – +7 | +8 |
| PAD OFF/Analog GAIN: +43 – +62 | +42 |

When Analog Reference Level is +4 dBu and Digital Reference Level is -14 dBFS

| Status before switching pad setting | Analog GAIN after switching pad setting |
|-------------------------------------|---|
| Analog GAIN: +6 – +40 | Same value |
| PAD ON/Analog GAIN: -14 – +5 | +6 |
| PAD OFF/Analog GAIN: +41 – +60 | +40 |

When Analog Reference Level is 0 dBu and Digital Reference Level is -20 dBFS

| Status before switching pad setting | Analog GAIN after switching pad setting |
|-------------------------------------|---|
| Analog GAIN: +8 – +42 | Same value |
| PAD ON/Analog GAIN: -12 – +7 | +8 |
| PAD OFF/Analog GAIN: +43 – +62 | +42 |

When Analog Reference Level is 0 dBu and Digital Reference Level is -18 dBFS

| Status before switching pad setting | Analog GAIN after switching pad setting |
|-------------------------------------|---|
| Analog GAIN: +6 – +40 | Same value |
| PAD ON/Analog GAIN: -14 – +5 | +6 |
| PAD OFF/Analog GAIN: +41 – +60 | +40 |

⑫ Analog GAIN knobs

- When the input source of the selected module is “ANALOG” or “SB-16D connected by built-in Dante”, this will show analog gain knobs for each channel of this unit or the SB-16D. These can be used to adjust input levels of MIC/LINE input jacks.

Turn LCD knob 1 (lit red) to adjust it.

When Analog Reference Level is +6 dBu and Digital Reference Level is -9 dBFS

| PAD button setting | Range |
|--------------------|--------------------|
| OFF | +3 (default) – +57 |
| ON | -17 – +37 |

When Analog Reference Level is +4 dBu and Digital Reference Level is -20 dBFS

| PAD button setting | Range |
|--------------------|---------------------|
| OFF | +12 (default) – +66 |
| ON | -8 – +46 |

When Analog Reference Level is +4 dBu and Digital Reference Level is -18 dBFS

| PAD button setting | Range |
|--------------------|---------------------|
| OFF | +10 (default) – +64 |
| ON | -10 – +44 |

When Analog Reference Level is +4 dBu and Digital Reference Level is -16 dBFS

| PAD button setting | Range |
|--------------------|--------------------|
| OFF | +8 (default) – +62 |
| ON | -12 – +42 |

When Analog Reference Level is +4 dBu and Digital Reference Level is -14 dBFS

| PAD button setting | Range |
|--------------------|--------------------|
| OFF | +6 (default) – +60 |
| ON | -14 – +40 |

When Analog Reference Level is 0 dBu and Digital Reference Level is -20 dBFS

| PAD button setting | Range |
|--------------------|--------------------|
| OFF | +8 (default) – +62 |
| ON | -12 – +42 |

When Analog Reference Level is 0 dBu and Digital Reference Level is -18 dBFS

| PAD button setting | Range |
|--------------------|--------------------|
| OFF | +6 (default) – +60 |
| ON | -14 – +40 |

- The indicators to the left of the Analog GAIN knobs appear to light as shown below depending on the input level.
Red: -3 dBFS, Green: -40 dBFS
- When the input source of the selected module is "ANALOG" or "SB-16D connected by built-in Dante", 2 Analog GAIN knobs will be shown together.
Turn LCD knob 1 (lit red) to adjust both together.
To operate them separately, turn the GANG function OFF on the MODULE (INPUT) screen.
- A black knob that cannot be operated will be shown if the input source is an SB-16D for which control privileges are not held.

NOTE

Explanation of Analog GAIN values

When signals at the Analog Reference Level (+6 dBu, +4 dBu, 0 dBu) are input, the Analog GAIN value that becomes the Digital Reference Level (-9 dBFS, -14 dBFS, -16 dBFS, -18 dBFS, -20 dBFS) at the digital stage is shown as "0".

⑬ Phase buttons

Use these to change the phases of the signals for the selected module.

Tap these buttons to reverse the phases of the selected module signals.

| | | |
|-----------------|-----------------|----------|
| L ϕ OFF | R ϕ OFF | Normal |
| L ϕ ON | R ϕ ON | Reversed |

⑭ D.TRIM knob

Use this to adjust the digital trim value.

Range: -50.0 dB – +20.0 dB (default: 0.0 dB)

Turn LCD knob 3 (lit red) to adjust it.

⑮ MUTE button

Tap this button to turn muting on/off for the selected module signal.

When MUTE is on, the button will be highlighted.

NOTE

The MUTE keys on the top of the unit can also be used to set this.

⑯ FADER LEVEL

Use this to adjust the FADER level of the selected module signal.

Range: $-\infty$ dB – +10.0 dB (default: $-\infty$ dB)

Turn LCD knob 7 (lit blue) to adjust it.

NOTE

- The channel faders on top of the unit can also be used for this adjustment.
- Tap the area while pressing the HOME key on the top panel to set the FADER level to 0 dB.

⑰ SENDS button

Tap this button to open the MODULE (SEND/PAN) Screen for the selected module. (See "MODULE (SEND/PAN) Screen" on page 144.)

⑱ MIX/FX SEND level indicators

- This list shows the on/off and PRE/POST states and the send levels to the MIX 1–22 and FX 1–4 buses. (See "⑧ ALL SEND button (ALL SEND)" on page 23.)
- Tap this area to open the MODULE (SEND/PAN) Screen for the selected module with the bus selected for the tapped area.

⑲ BAL

- This adjusts the balance of the signals sent to the MAIN L/R bus. Turn LCD knob 8 (lit yellow) to adjust it.

Range: L100 – C – R100 (default: C)

- When the **MAIN** icon is highlighted (**MAIN**), signals are being sent to the MAIN L/R bus.
- Tap this area to open the MODULE (SEND/PAN) Screen for the selected module. (See "MODULE (SEND/PAN) Screen" on page 144.)

NOTE

Tap this area while pressing the HOME key on the top panel to set the balance to center (C).

6 – Modules

FX RTN 1–4 MODULE (OVERVIEW) Screens

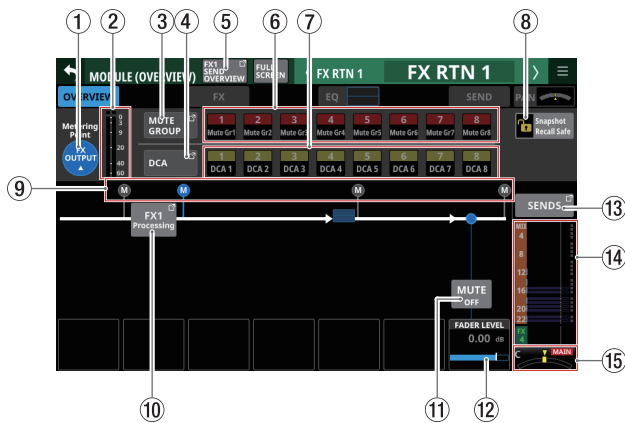

① Metering Point button

- This shows the name of the set metering point.
- Tap this button to open a window for setting metering points for FX RTN 1–4 modules.

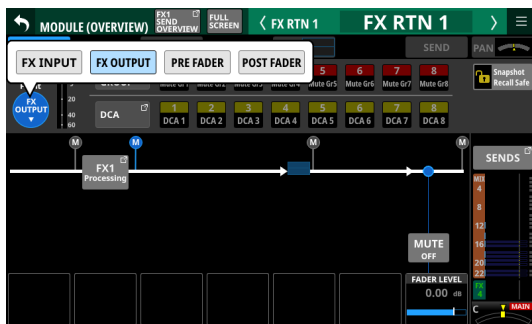

Options: FX INPUT, FX OUTPUT (default), PRE FADER, POST FADER

Tap an option to switch the metering point for the level meter.

NOTE

Metering points can also be changed on the METERING POINT page of the METER SETUP Screen. (See “METERING POINT page” on page 40.)

② Level meters

This shows the level of the signal at the set metering point.

③ MUTE GROUP button

Tap this button to open the DCA/Mute Group SETUP Screen Mute Group Assign page. (See “Mute Group Assign page” on page 164.)

④ DCA button

Tap this button to open the DCA/Mute Group SETUP Screen DCA Assign page. (See “DCA Assign page” on page 163.)

⑤ SEND OVERVIEW button

Tap this button to open the SEND OVERVIEW Screen for the selected FX RTN module. (See “FX 1–4 bus SEND OVERVIEW Screen” on page 156.)

⑥ MUTE GROUP 1–8 buttons

Tap these buttons to change Mute Group assignment states. (Default: off)

Assigned buttons will be highlighted.

⑦ DCA 1–8 buttons

Tap these buttons to change DCA assignment states. (Default: off)

Assigned buttons will be highlighted.

⑧ Snapshot Recall Safe button

Tap this button to enable the Snapshot Recall Safe function for the selected module. (Default: off)

When this is on, the button will appear highlighted.

NOTE

This can also be set on the MODULE SAFE page of the SNAPSHOT RECALL SAFE Screen. (See “MODULE SAFE page” on page 178.)

⑨ Metering Point position indicator

The highlighted indicator shows the position of the set metering point.

⑩ FX Processing button

Tap this button to open the MODULE (FX) Screen. (See “MODULE (FX) Screen” on page 132.)

⑪ MUTE button

Tap this button to turn muting on/off for the selected module signal.

When MUTE is on, the button will be highlighted.

NOTE

The MUTE keys on the top of the unit can also be used to set this.

⑫ FADER LEVEL

Use this to adjust the FADER level of the selected module signal.

Range: $-\infty$ dB – +10.0 dB (default: 0.0 dB)

Turn LCD knob 7 (lit blue) to adjust it.

NOTE

- The channel faders on top of the unit can also be used for this adjustment.

- Tap the area while pressing the HOME key on the top panel to set the FADER level to 0 dB.

⑬ SENDS button

Tap this button to open the MODULE (SEND/PAN) Screen for the selected module. (See “MODULE (SEND/PAN) Screen” on page 144.)

⑭ MIX/FX SEND level indicators

- This list shows the on/off and PRE/POST states and the send levels to the MIX 1–22 and FX 1–4 buses. (See “⑧ ALL SEND button (ALL SEND)” on page 23.)

- Tap this area to open the MODULE (SEND/PAN) Screen for the selected module with the bus selected for the tapped area.

⑮ BAL

- This adjusts the balance of the signals sent to the MAIN L/R bus. Turn LCD knob 8 (lit yellow) to adjust it.

Range: L100 – C – R100 (default: C)

- When the **MAIN** icon is highlighted (**MAIN**), signals are being sent to the MAIN L/R bus.

- Tap this area to open the MODULE (SEND/PAN) Screen for the selected module. (See “MODULE (SEND/PAN) Screen” on page 144.)

NOTE

Tap this area while pressing the HOME key on the top panel to set the balance to center (C).

MIX 1–22 and MAIN L/R Master MODULE (OVERVIEW) Screens

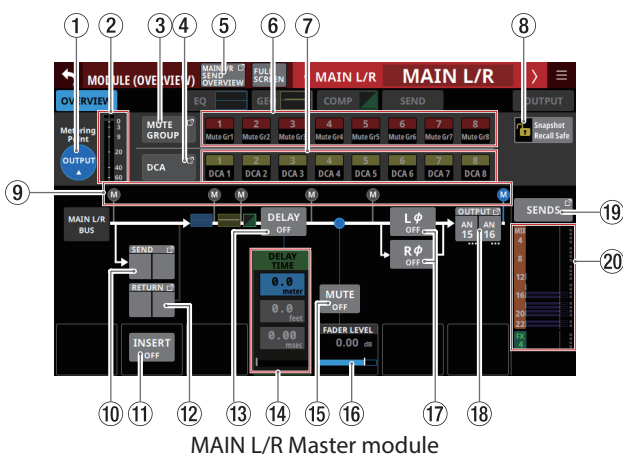
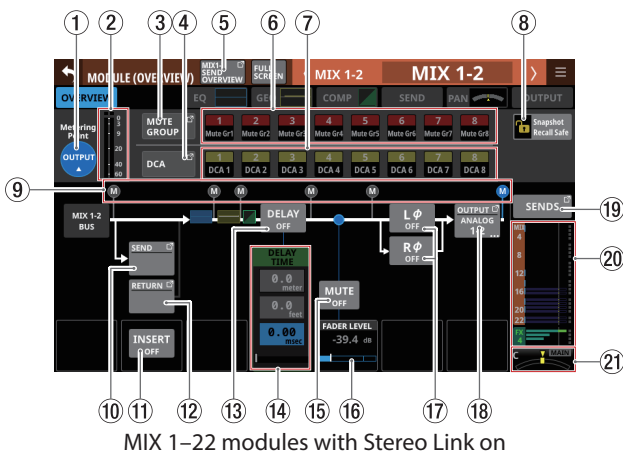
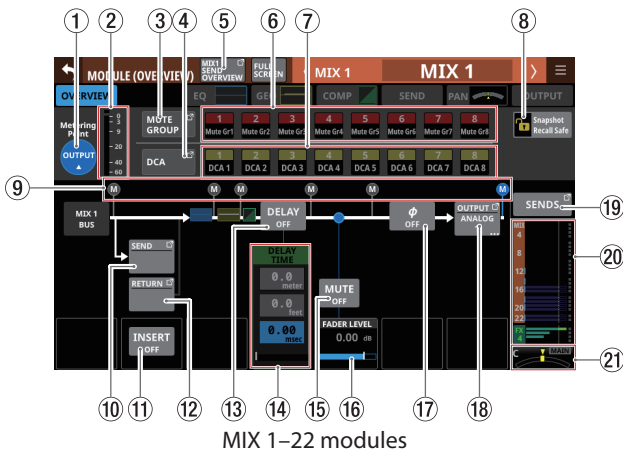

① Metering Point button

- This shows the name of the set metering point.
- Tap this button to open a window for setting the metering point.

Metering point settings for the MIX 1–22 modules and the MAIN L/R Master module are set separately for the AUX mode bus MAIN L/R module and the GROUP mode bus.

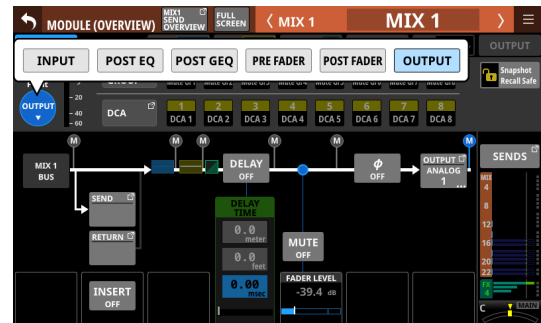

Options: INPUT, POST EQ, POST GEQ, PRE FADER, POST FADER, OUTPUT

| | |
|---|------------|
| Aux mode bus and MAIN L/R module defaults | OUTPUT |
| GROUP mode bus default | POST FADER |

Tap an option to switch the metering point for the level meter.

NOTE

- Metering points can also be changed on the METERING POINT page of the METER SETUP Screen. (See “METERING POINT page” on page 40.)
- When the Metering Point is OUTPUT, and the corresponding bus has not been assigned to an output port (not being output from the unit), meters will not be shown.

② Level meters

This shows the level of the signal at the set metering point.

③ MUTE GROUP button

Tap this button to open the DCA/Mute Group SETUP Screen Mute Group Assign page. (See “Mute Group Assign page” on page 164.)

④ DCA button

Tap this button to open the DCA/Mute Group SETUP Screen DCA Assign page. (See “DCA Assign page” on page 163.)

⑤ SEND OVERVIEW button

Tap this button to open the SEND OVERVIEW Screen for the selected module. (See “MIX 1–22 bus SEND OVERVIEW Screen” on page 153 and “MAIN L/R bus SEND OVERVIEW Screen” on page 158.)

⑥ MUTE GROUP 1–8 buttons

Tap these buttons to change Mute Group assignment states. (Default: off)
Assigned buttons will be highlighted.

6 – Modules

⑦ DCA 1–8 buttons

Tap these buttons to change DCA assignment states. (Default: off)
Assigned buttons will be highlighted.

⑧ Snapshot Recall Safe button

Tap this button to enable the Snapshot Recall Safe function for the selected module. (Default: off)
When this is on, the button will appear highlighted.

NOTE

This can also be set on the MODULE SAFE page of the SNAPSHOT RECALL SAFE Screen. (See “MODULE SAFE page” on page 178.)

⑨ Metering Point position indicator

This shows the position of the set metering point.

⑩ SEND button

- This shows the name of the output port that the INSERT SEND signal is assigned to. If it has been assigned to multiple output ports, “...” will appear to the bottom right of the button.
- If the module is stereo, output port names will appear split left and right and abbreviated as follows.

| Module name shown | Stereo module name shown |
|-------------------|--------------------------|
| SLOT 1 | S1 |
| SLOT 2 | S2 |

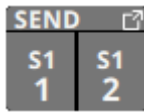

- Tap this button to open the INSERT SEND PORT SELECT Screen. (See “INSERT SEND PORT SELECT screen” on page 110.)

⑪ INSERT button

Tap this button to turn the INSERT on/off. (Default: OFF)
When this is ON, the button will appear highlighted.

⑫ RETURN button

- This shows the name of the input port that is assigned for the INSERT RETURN signal.
- If the module is stereo, input port names will appear split left and right and abbreviated as follows.

| Module name shown | Stereo module name shown |
|-------------------|--------------------------|
| SLOT 1 | S1 |
| SLOT 2 | S2 |



- Tap this button to open the INSERT RETURN PORT SELECT Screen. (See “INSERT RETURN PORT SELECT screen” on page 111.)

⑬ DELAY button

Tap this button to turn the delay function ON or OFF (default). This can be used to adjust the timing of the output signal, for example. (Default: OFF)
When this is on, the button will appear highlighted.

⑭ DELAY TIME

This adjusts the DELAY TIME.
The highlighted unit will be used for operation, so tap the button for the desired unit.

| Unit options | Range (unit) |
|----------------|-------------------|
| meter | 0 – 117.3 (meter) |
| feet | 0 – 384.8 (feet) |
| msec (default) | 0 – 341.32 (msec) |

Turn LCD knob 4 (lit green) to adjust it.

⑮ MUTE button

Tap this button to turn muting on/off for the selected module signal.
When MUTE is on, the button will be highlighted.

NOTE

The MUTE keys on the top of the unit can also be used to set this.

⑯ FADER LEVEL

Use this to adjust the FADER level of the selected module signal.

Range: $-\infty$ dB – +10.0 dB (default: 0.0 dB)

Turn LCD knob 5 (lit blue) to adjust it.

NOTE

- The channel faders on top of the unit can also be used for this adjustment.
- Tap the area while pressing the HOME key on the top panel to set the FADER level to 0 dB.

⑰ Phase buttons

Use these to change the phases of the signals for the selected module.

Tap these buttons to reverse the phases of the selected module signals.

- Phase button display when the Stereo Link setting is off for the selected module

| | |
|--|----------|
| | Normal |
| | Reversed |

- Phase button display when the selected module is stereo

| | |
|--|----------|
| | Normal |
| | Reversed |

18 OUTPUT button

- This shows the name of the output port that the output signal of the selected module is assigned to. If it has been assigned to multiple output ports, “...” will appear to the bottom right of the button.
- If the module is stereo, output port names will appear split left and right and abbreviated as follows.

| Module name shown | Stereo module name shown |
|-------------------|--------------------------|
| ANALOG | AN |
| Dante | DA |
| SLOT 1 | S1 |
| SLOT 2 | S2 |
| USB OUT | USB |

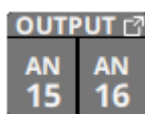

- If a Dante port that has a mounted SB-16D assigned is selected, “SB #[ID] [port number]” will be shown.



If it is a virtually-mounted SB-16D,  will appear.



- Tap this button to open the OUTPUT PORT SELECT Screen. (See “OUTPUT PORT SELECT screen” on page 112.)



19 SENDS button

Tap this button to open the MODULE (SEND/PAN) Screen for the selected module. (See “MODULE (SEND/PAN) Screen” on page 144.)

20 MIX/FX SEND level indicators

- This list shows the on/off status and the send levels to the MIX 1–22 and FX 1–4 buses. (See “10 ALL SEND button ” on page 26.)
- Tap this area to open the MODULE (SEND/PAN) Screen for the selected module with the bus selected for the tapped area.

21 PAN/BAL (MIX 1–22 modules only)

- This adjusts the panning/balance of the signals sent to the MAIN L/R bus. Turn LCD knob 8 (lit yellow) to adjust it.
Range: L100 – C – R100 (default: C)
- When the  icon is highlighted () , signals are being sent to the MAIN L/R bus.
- Tap this area to open the MODULE (SEND/PAN) Screen for the selected module. (See “MODULE (SEND/PAN) Screen” on page 144.)

NOTE

Tap this area while pressing the HOME key on the top panel to set panning/balance to center (C).

6 – Modules

MODULE (INPUT) Screen

Set module input settings on the MODULE (INPUT) Screens for CH 1–40 and ST IN 1–2 modules.

Tap the INPUT area on the Home Screen when the selection frame is shown to open this screen.

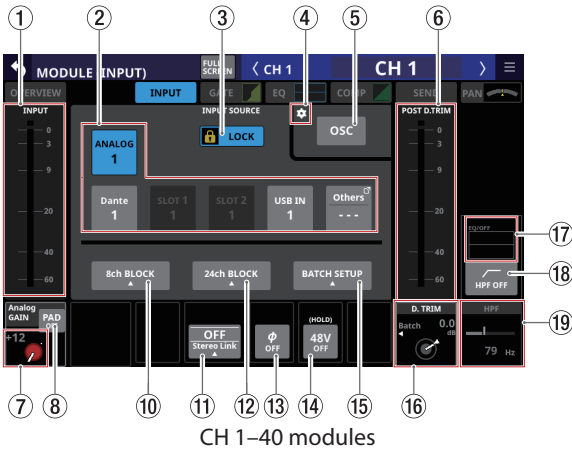

CH 1–40 modules

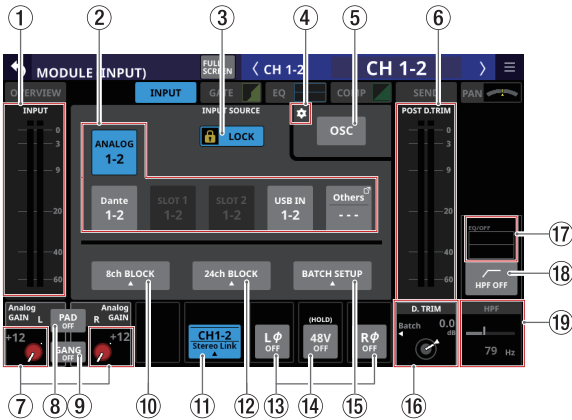

CH 1–40 modules with Stereo Link on

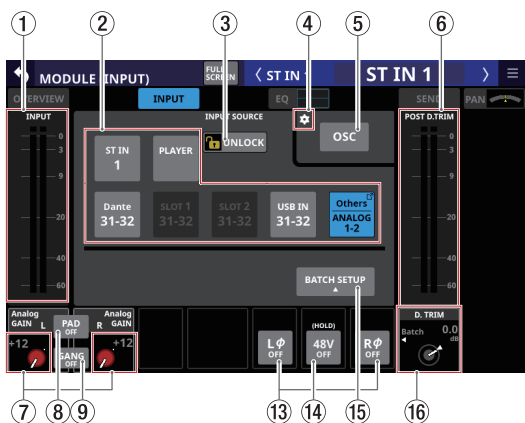

ST IN 1–2 modules with input source set to ANALOG

① INPUT level meter area

This shows the input signal level(s) of the selected module.

② INPUT SOURCE buttons

- When the LOCK/UNLOCK button (③) is set to “UNLOCK”, tap these buttons to select the input source of the selected module. Only the one button for the selected input source will be highlighted.
- Buttons for Dante ports that have mounted SB-16Ds assigned will be shown as “SB #[ID] [port number]”.

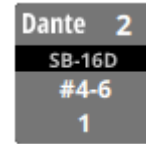

If it is a virtually-mounted SB-16D, (V) will appear to the top right.



- Assigned buttons for Dante ports that have virtually mounted SB-16Ds will be highlighted yellow.



- If the selected input source is not shown by one of the buttons on the screen, it will be shown on the Others button.
- If the module is stereo and input sources that are not left-right adjacent are selected, input source names will appear split left and right and abbreviated as follows on the Others button.

| Module name shown | Stereo module name shown |
|-------------------|--------------------------|
| ANALOG | AN |
| Dante | DA |
| SLOT 1 | S1 |
| SLOT 2 | S2 |
| USB IN | USB |
| ST IN 1 | ST1 |
| ST IN 2 | ST2 |
| PLAYER | PL |



- Tap the Others button to open the INPUT SOURCE SELECT Screen. (See “INPUT SOURCE SELECT screen” on page 106.)

③ LOCK/UNLOCK button

- This button locks/unlocks routing setting change operations for the unit. This is always locked at the time of start up.
- When set to “LOCK”, tapping INPUT SOURCE (②) and OSC (⑤) buttons will not change settings. Furthermore, the 8ch BLOCK, 16ch BLOCK, 24ch BLOCK and BATCH SETUP buttons will also be disabled. However, tapping the Others button and switching to the INPUT SOURCE SELECT Screen is possible.
- When set to “LOCK”, tap this button to open a confirmation message. Tap the UNLOCK button to close the message and set it to “UNLOCK”. Tapping the CANCEL button on the confirmation message will close it and maintain the locked state.

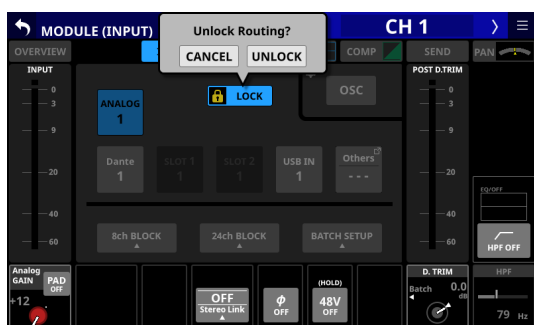

- Tap this button when set to “UNLOCK” to switch it to “LOCK”.

NOTE

The LOCK/UNLOCK button (③) setting is shared by the following routing setting screens.

- MODULE (INPUT) Screen
- MODULE (OUTPUT) Screen
- INPUT SOURCE SELECT Screen
- OUTPUT PORT SELECT Screen
- DIRECT OUT PORT SELECT Screen
- INSERT SEND PORT SELECT Screen
- INSERT RETURN PORT SELECT Screen

④ icon

Tap this icon to open the TALKBACK/OSCILLATOR page of the MONITOR SETUP Screen. (See “Making talkback and built-in oscillator settings” on page 62.)

⑤ OSC button

When the LOCK/UNLOCK button (③) is set to “UNLOCK”, tap this button to turn internal oscillator input on or off (default).

When on, the signal from the internal oscillator will be input to the selected module while maintaining the input source setting for that module. (Default: OFF)

When on, this button will appear highlighted and the INPUT SOURCE selection (②) button area will be dimmed.

⑥ POST D. TRIM level meter(s)

This shows the signal level(s) after the D. TRIM.

⑦ Analog GAIN knob and indicator

- When the input source of the selected module is “ANALOG” or “SB-16D connected by built-in Dante”, this will show an analog gain knob that can be used to adjust the input level of the MIC/LINE input jacks on this unit or the SB-16D.

Turn LCD knob 1 (lit red) to adjust it.

When Analog Reference Level is +6 dBu and Digital Reference Level is -9 dBFS

| PAD button setting | Range |
|--------------------|--------------------|
| OFF | +3 (default) – +57 |
| ON | -17 – +37 |

When Analog Reference Level is +4 dBu and Digital Reference Level is -20 dBFS

| PAD button setting | Range |
|--------------------|---------------------|
| OFF | +12 (default) – +66 |
| ON | -8 – +46 |

When Analog Reference Level is +4 dBu and Digital Reference Level is -18 dBFS

| PAD button setting | Range |
|--------------------|---------------------|
| OFF | +10 (default) – +64 |
| ON | -10 – +44 |

When Analog Reference Level is +4 dBu and Digital Reference Level is -16 dBFS

| PAD button setting | Range |
|--------------------|--------------------|
| OFF | +8 (default) – +62 |
| ON | -12 – +42 |

When Analog Reference Level is +4 dBu and Digital Reference Level is -14 dBFS

| PAD button setting | Range |
|--------------------|--------------------|
| OFF | +6 (default) – +60 |
| ON | -14 – +40 |

When Analog Reference Level is 0 dBu and Digital Reference Level is -20 dBFS

| PAD button setting | Range |
|--------------------|--------------------|
| OFF | +8 (default) – +62 |
| ON | -12 – +42 |

When Analog Reference Level is 0 dBu and Digital Reference Level is -18 dBFS

| PAD button setting | Range |
|--------------------|--------------------|
| OFF | +6 (default) – +60 |
| ON | -14 – +40 |

- The indicators to the left of the Analog GAIN knobs appear to light as shown below depending on the input level.

Red: -3 dBFS, Green: -40 dBFS

- When the input source of the selected module is an “ANALOG” stereo module, 2 Analog GAIN knobs will be shown.

Use LCD knobs 1–2 (lit red) to adjust them.

6 – Modules

- A black knob that cannot be operated will be shown if the input source is an SB-16D for which control privileges are not held.

NOTE

Explanation of Analog GAIN values

When signals at the Analog Reference Level (+6 dBu, +4 dBu, 0 dBu) are input, the Analog GAIN value that becomes the Digital Reference Level (-9 dBFS, -14 dBFS, -16 dBFS, -18 dBFS, -20 dBFS) at the digital stage is shown as "0".

⑧ PAD button

- This shows the PAD button when the input source of the selected module is "ANALOG" or "SB-16D connected by built-in Dante".
If the selected module is a stereo module and the input sources for both the left and right channels are "ANALOG" or "SB-16D connected by built-in Dante", this shows the left channel setting.
- Tap this button to turn the -20dB pad on/off. (Default: off)
If the selected module is a stereo module and the input sources for both the left and right channels are "ANALOG" or "SB-16D connected by built-in Dante", this switches the -20dB pad on/off for both channels.
When this button is on, it will appear highlighted.
- A black button that cannot be operated will be shown if the input source is an SB-16D for which control privileges are not held.

NOTE

When the pad is switched on/off, the Analog GAIN value will be controlled as shown below so that it changes as little as possible.

When Analog Reference Level is +6 dBu and Digital Reference Level is -9 dBFS

| Status before switching pad setting | Analog GAIN after switching pad setting |
|-------------------------------------|---|
| Analog GAIN: +3 – +37 | Same value |
| PAD ON/Analog GAIN: -17 – +2 | +3 |
| PAD OFF/Analog GAIN: +38 – +57 | +37 |

When Analog Reference Level is +4 dBu and Digital Reference Level is -20 dBFS

| Status before switching pad setting | Analog GAIN after switching pad setting |
|-------------------------------------|---|
| Analog GAIN: +12 – +46 | Same value |
| PAD ON/Analog GAIN: -8 – +11 | +12 |
| PAD OFF/Analog GAIN: +47 – +66 | +46 |

When Analog Reference Level is +4 dBu and Digital Reference Level is -18 dBFS

| Status before switching pad setting | Analog GAIN after switching pad setting |
|-------------------------------------|---|
| Analog GAIN: +10 – +44 | Same value |
| PAD ON/Analog GAIN: -10 – +9 | +10 |
| PAD OFF/Analog GAIN: +45 – +64 | +44 |

When Analog Reference Level is +4 dBu and Digital Reference Level is -16 dBFS

| Status before switching pad setting | Analog GAIN after switching pad setting |
|-------------------------------------|---|
| Analog GAIN: +8 – +42 | Same value |
| PAD ON/Analog GAIN: -12 – +7 | +8 |
| PAD OFF/Analog GAIN: +43 – +62 | +42 |

When Analog Reference Level is +4 dBu and Digital Reference Level is -14 dBFS

| Status before switching pad setting | Analog GAIN after switching pad setting |
|-------------------------------------|---|
| Analog GAIN: +6 – +40 | Same value |
| PAD ON/Analog GAIN: -14 – +5 | +6 |
| PAD OFF/Analog GAIN: +41 – +60 | +40 |

When Analog Reference Level is 0 dBu and Digital Reference Level is -20 dBFS

| Status before switching pad setting | Analog GAIN after switching pad setting |
|-------------------------------------|---|
| Analog GAIN: +8 – +42 | Same value |
| PAD ON/Analog GAIN: -12 – +7 | +8 |
| PAD OFF/Analog GAIN: +43 – +62 | +42 |

When Analog Reference Level is 0 dBu and Digital Reference Level is -18 dBFS

| Status before switching pad setting | Analog GAIN after switching pad setting |
|-------------------------------------|---|
| Analog GAIN: +6 – +40 | Same value |
| PAD ON/Analog GAIN: -14 – +5 | +6 |
| PAD OFF/Analog GAIN: +41 – +60 | +40 |

⑨ GANG button

- This shows the GANG button when the input source of the selected module is an "ANALOG" or "SB-16D connected by built-in Dante" stereo module.
- Tap this button to turn the GANG function on/off. Turning the GANG function on, highlighting the button, will enable the simultaneous linked operation of the 2 Analog GAIN knobs. (Default: OFF)

⑩ 8ch BLOCK button (CH 1–40 modules only)

When the LOCK/UNLOCK button (③) is set to "UNLOCK", tap this button to open a window where the input sources of 8 channels can be set at the same time. (See "Setting input sources for multiple channels at the same time in blocks" on page 100.)



Change settings for multiple designated channels at the same time.

NOTE

- This cannot be used when the LOCK/UNLOCK button (③) is set to "LOCK".
- If routing operation is set to "LOCK" on another touchscreen while a multiple setting window is open, it will close automatically.

11 Stereo Link button (CH 1–40 modules only)

- This shows the stereo link setting of the input channel.

| | |
|---|-----------------------|
|  | Stereo linking is off |
|  | Stereo linking is on |

- Tap this button to open the Stereo Link setting window.

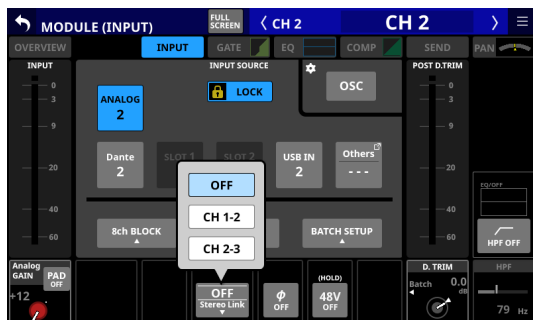

Linking with either module to the left or right is possible except for channels 1 and 40.

12 16ch BLOCK button (Sonicview 16, CH 1–32 modules only) or 24ch BLOCK button (Sonicview 24, CH 1–40 modules only)

When the LOCK/UNLOCK button (3) is set to “UNLOCK”, tap this button to open a window where the input sources of 16 (Sonicview 16) or 24 (Sonicview 24) channels can be set at the same time. (See “Setting input sources for multiple channels at the same time in blocks” on page 100.)

Change settings for multiple designated channels at the same time.

NOTE



- This cannot be used when the LOCK/UNLOCK button (3) is set to “LOCK”.
- If routing operation is set to “LOCK” on another touchscreen while a multiple setting window is open, it will close automatically.

13 Phase button



Use this to change the phase of the signal for the selected module.

Tap this button to reverse the phase of the selected module signal.

- Phase button display when the Stereo Link setting is off for the selected CH 1–40 module

| | |
|---|----------|
|  | Normal |
|  | Reversed |

- Phase button display for stereo modules

| | |
|---|----------|
|  | Normal |
|  | Reversed |

14 48V button

- This shows the phantom power setting status when the input source of the selected module is “ANALOG” or “SB-16D connected by built-in Dante”.
If the selected module is a stereo module and the input sources for both the left and right channels are “ANALOG” or “SB-16D connected by built-in Dante”, this shows the left channel setting.
- Touch and hold the +48V button to turn phantom power (+48V) on/off. (Default: OFF)
If the selected module is a stereo module and the input sources for both the left and right channels are “ANALOG” or “SB-16D connected by built-in Dante”, this switches phantom power on/off for both channels.
When phantom power is on, the button will be highlighted.
- A black button that cannot be operated will be shown if the input source is an SB-16D for which control privileges are not held.

15 BATCH SETUP button

When the LOCK/UNLOCK button (3) is set to “UNLOCK”, tap this button to open a BATCH SETUP window where the input sources of a range of channels can be set at the same time. (See “Setting inputs sources for multiple channels at the same time in batches” on page 100.)

Change settings for multiple designated channels at the same time.

NOTE

- This cannot be used when the LOCK/UNLOCK button (3) is set to “LOCK”.
- If routing operation is set to “LOCK” on another touchscreen while a multiple setting window is open, it will close automatically.

16 D.TRIM knob

- Use this to adjust the digital trim value.
Range: -50.0 dB – +20.0 dB (default: 0.0 dB)
Turn LCD knob 7 (lit red) to adjust it.
- Tap this area to open a BATCH SETUP window where the digital trim value of a range of channels can be set at the same time. (See “Setting digital trim values in batches” on page 132.)

17 HPF/EQ frequency response graphs (CH 1–40 modules only)

- This shows graphs of the HPF and EQ frequency responses.
- When HPF and EQ are on, this will appear highlighted.
- When HPF and EQ are off, this will appear gray.
- When only HPF or EQ is on, the frequency response of that function will be highlighted.

18 HPF button (CH 1–40 modules only)

Tap this button to turn the HPF on/off. (Default: OFF)
When this is ON, the button will appear highlighted.

19 HPF frequency (CH 1–40 modules only)

This adjusts the cutoff frequency of the HPF.
Range: 20 Hz - 1.0 kHz (default: 79 Hz)
Turn LCD knob 8 (lit light blue) to adjust it.
When this is on, it will appear highlighted.

6 – Modules

Setting digital trim values in batches

1. Tap the D.TRIM knob indicator to open a BATCH SETUP window where digital trim values can be set in batches.

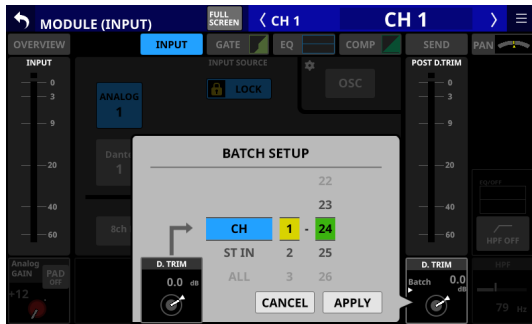

2. Swipe the options up and down to select the modules to include in batch setting of digital trim values. Selections can also be changed by turning the LCD Knobs 4–6 with the same colors.
3. Use the LCD knob 3, which is lit red, to adjust the trim level.
4. Tap the APPLY button to open a setting confirmation window.

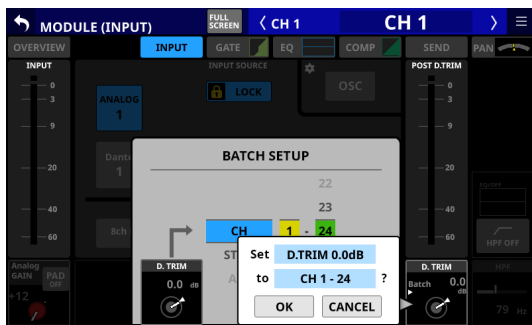

5. Tap the OK button to set multiple digital trim values at the same time. The BATCH SETUP window will close.

MODULE (FX) Screen

Make effect settings on the MODULE (FX) Screen of the FX RTN 1–4 modules.

Tap the FX area on the Home Screen when the selection frame is shown to open this screen.

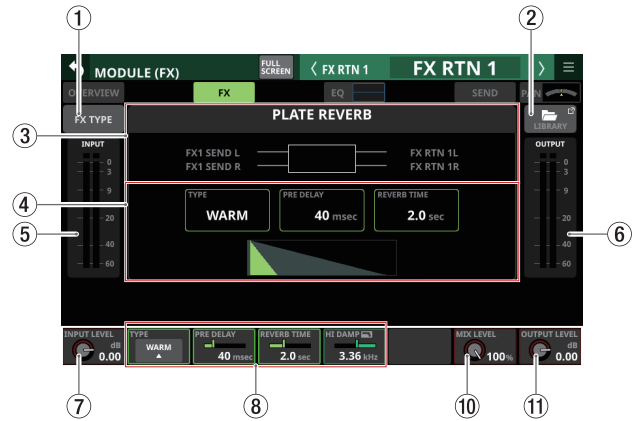

FX RTN 1–4 module with PLATE REVERB

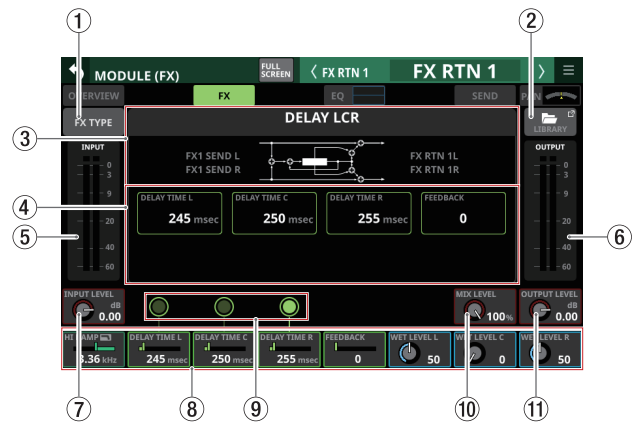

FX RTN 1–4 module with DELAY LCR

① FX TYPE button

Tap this button to open the effect type selection window for the selected module.

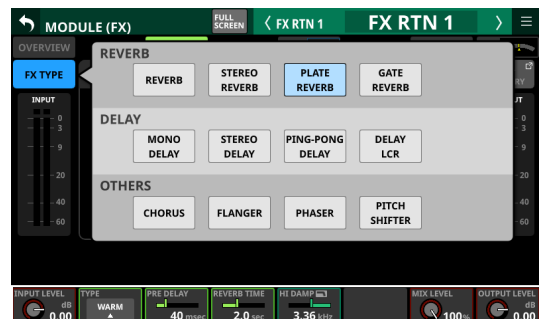

Tap a button to select an effect type. Selecting will close the selection window.

② LIBRARY button

Tap this button to open the effect LIBRARY Screen. (See “Various LIBRARY Screens” on page 182.)

③ Effect type information

This shows the following information about the selected effect type.

- FX TYPE name
- FX LIBRARY name (if FX LIBRARY RECALL/STORE used)
- Block diagram of the effect input/output algorithm

④ Main parameter settings

This shows the main parameter settings of the selected effect.

⑤ INPUT level meters

This shows signal levels input to the effect.

⑥ OUTPUT level meters

This shows the signal levels output from the effect.

⑦ INPUT LEVEL knob

This adjusts the levels input to the effect.

Range: $-\infty$ dB – +10 dB (default: 0.0 dB)

When the selection frame is shown, use the corresponding LCD knob 1 to adjust the value.

⑧ Effect parameters

These show effect parameters and can be used to adjust them.

When a selection frame is shown, use the corresponding LCD knobs and buttons to change settings.

⑨ Tap tempo input buttons and tempo indicators (for DELAY FX TYPE only)

- Tap these buttons to set the tap intervals as the DELAY TIME values.
- The centers of the tap tempo buttons function as tempo indicators, and blink at the DELAY TIME intervals. If a DELAY TIME is “200 msec” or less, the indicator will stay highlighted.

NOTE

Using the User Defined Control function, tap tempo input can also be operated with USER KEY, FOOTSWITCH and GPIO-IN controls. (See “USER DEFINED CONTROLS screen” on page 44.)

Tap tempo input is assigned as follows on the Foot Switch and GPIO-IN pages by default.

- Foot Switch (Tap Tempo FX3 Delay1)
- GPIO-IN 7 (Tap Tempo FX3 Delay1)
- GPIO-IN 8 (Tap Tempo FX4 Delay1)

⑩ MIX LEVEL knob

Use this to adjust the MIX levels of the dry and wet sounds.

Range: 0% (dry sound only) – 100% (default, wet sound only)

When the selection frame is shown, use the corresponding LCD knob 7 to adjust the value.

⑪ OUTPUT LEVEL knob

Use this to adjust the output level from the effect.

Range: $-\infty$ dB – +10 dB (default: 0.0 dB)

When the selection frame is shown, use the corresponding LCD knob 8 to adjust the value.

Effect parameters

REVERB

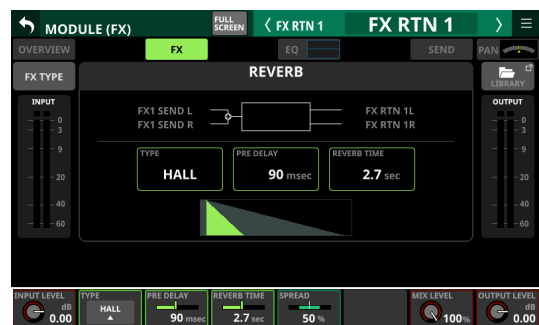

| Parameter name | Range | default |
|----------------|--------------------------|---------|
| TYPE | HALL, ROOM, STUDIO, LIVE | HALL |
| PRE DELAY | 0 msec – 200 msec | 90 msec |
| REVERB TIME | 0.1 sec – 10 sec | 2.7 sec |
| SPREAD | 0% – 100% | 50% |

STEREO REVERB

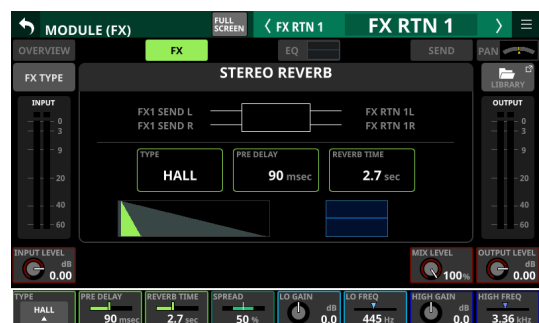

| Parameter name | Range | default |
|----------------|----------------------|----------|
| TYPE | HALL, ROOM | HALL |
| PRE DELAY | 0 msec – 200 msec | 90 msec |
| REVERB TIME | 0.1 sec – 20.0 sec | 2.7 sec |
| SPREAD | 0% – 100% | 50% |
| LO GAIN | -12 dB – +12 dB | 0 dB |
| LO FREQ | 125 Hz – 2.00 kHz | 445 Hz |
| HIGH GAIN | -12 dB – +12 dB | 0 dB |
| HIGH FREQ | 1.00 kHz – 16.00 kHz | 3.36 kHz |

6 – Modules

PLATE REVERB

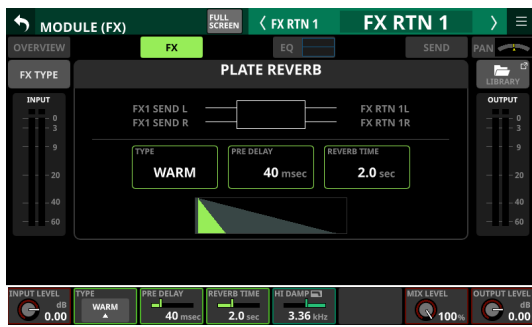

| Parameter name | Range | default |
|----------------|--------------------------|----------|
| TYPE | WARM, HARD, BRIGHT, DARK | WARM |
| PRE DELAY | 0 msec – 200 msec | 40 msec |
| REVERB TIME | 0.1 sec – 10 sec | 2.0 sec |
| HI DAMP | 500 Hz – 16.0 kHz | 3.36 kHz |

GATE REVERB

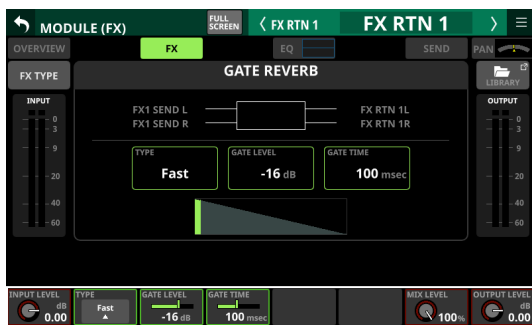

| Parameter name | Range | default |
|----------------|---------------------|----------|
| TYPE | Fast, Slow | Fast |
| GATE LEVEL | -48 dB – 0 dB | -16 dB |
| GATE TIME | 10 msec – 3000 msec | 100 msec |

MONO DELAY

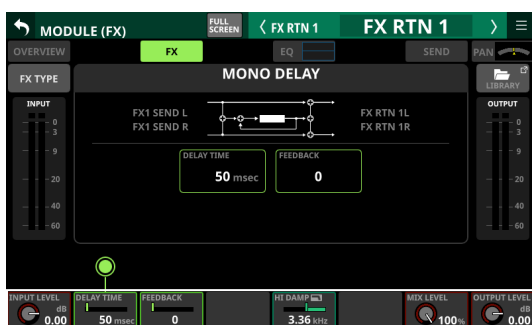

| Parameter name | Range | default |
|----------------|--------------------|----------|
| DELAY TIME | 1 msec – 3000 msec | 50 msec |
| FEEDBACK | 0 – 100 | 0 |
| HI DAMP | 500 Hz – 16.0 kHz | 3.36 kHz |

STEREO DELAY

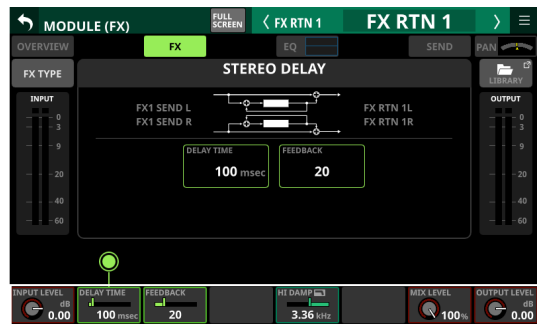

| Parameter name | Range | default |
|----------------|--------------------|----------|
| DELAY TIME | 1 msec – 1500 msec | 100 msec |
| FEEDBACK | 0 – 100 | 20 |
| HI DAMP | 500 Hz – 16.0 kHz | 3.36 kHz |

PING-PONG DELAY

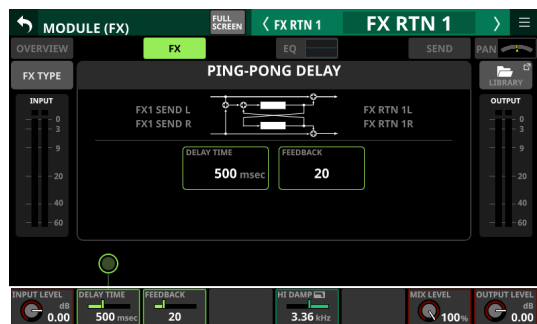

| Parameter name | Range | default |
|----------------|--------------------|----------|
| DELAY TIME | 1 msec – 1500 msec | 500 msec |
| FEEDBACK | 0 – 100 | 20 |
| HI DAMP | 500 Hz – 16.0 kHz | 3.36 kHz |

DELAY LCR

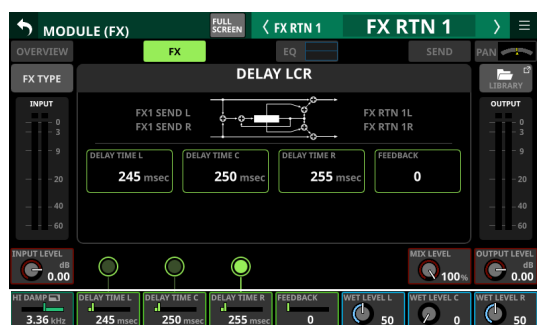

| Parameter name | Range | default |
|----------------|--------------------|----------|
| HI DAMP | 500 Hz – 16.0 kHz | 3.36 kHz |
| DELAY TIME L | 1 msec – 3000 msec | 245 msec |
| DELAY TIME C | 1 msec – 3000 msec | 250 msec |
| DELAY TIME R | 1 msec – 3000 msec | 255 msec |
| FEEDBACK | 0 – 100 | 0 |
| WET LEVEL L | 0 – 100 | 50 |
| WET LEVEL C | 0 – 100 | 0 |
| WET LEVEL R | 0 – 100 | 50 |

CHORUS

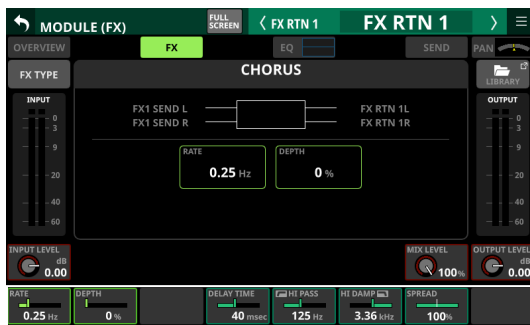

| Parameter name | Range | default |
|----------------|--------------------|----------|
| RATE | 0.05 Hz – 10.00 Hz | 0.25 Hz |
| DEPTH | 0% – 100% | 0% |
| DELAY TIME | 0 msec – 100 msec | 40 msec |
| HI PASS | 22 Hz – 2.00 kHz | 125 Hz |
| HI DAMP | 500 Hz – 16.0 kHz | 3.36 kHz |
| SPREAD | 0% – 100% | 100% |

FLANGER

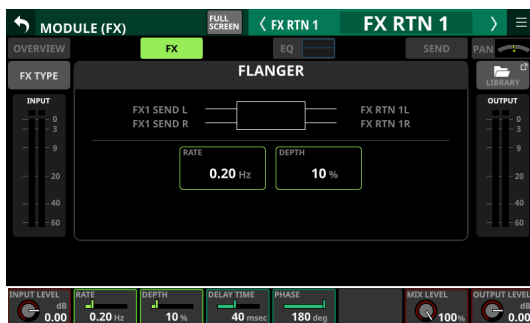

| Parameter name | Range | default |
|----------------|--------------------|---------|
| RATE | 0.05 Hz – 10.00 Hz | 0.20 Hz |
| DEPTH | 0% – 100% | 10% |
| DELAY TIME | 0 msec – 100 msec | 40 msec |
| PHASE | 0 deg – 180 deg | 180 deg |

PHASER

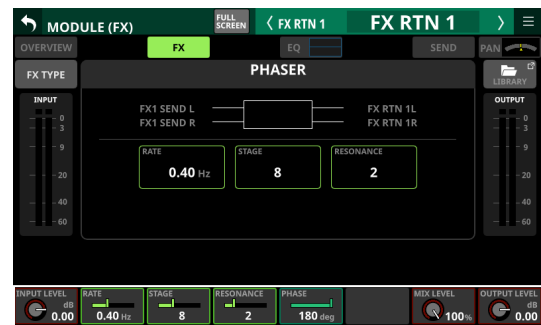

| Parameter name | Range | default |
|----------------|-------------------|---------|
| RATE | 0.05 Hz – 10.0 Hz | 0.40 Hz |
| STAGE | 4 – 16 | 8 |
| RESONANCE | 0 – 10 | 2 |
| PHASE | 0 deg – 180 deg | 180 deg |

PITCH SHIFTER

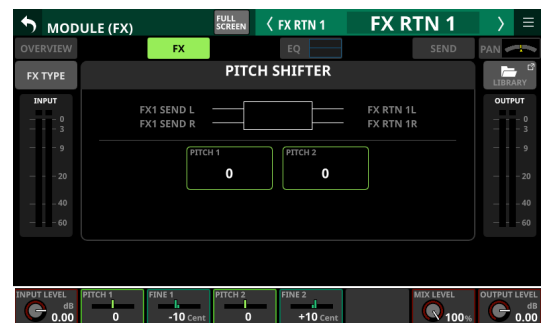

| Parameter name | Range | default |
|----------------|---------------------|----------|
| PITCH 1 | -24 – +24 | 0 |
| FINE 1 | -50 Cent – +50 Cent | -10 Cent |
| PITCH 2 | -24 – +24 | 0 |
| FINE 2 | -50 Cent – +50 Cent | +10 Cent |

6 – Modules

MODULE (GATE/EXPANDER/DE-ESSER) screens

GATE, EXPANDER and DE-ESSER settings can be made on the MODULE (GATE), MODULE (EXPANDER) and MODULE (DE-ESSER) screens for the CH 1–40 modules.

Tap the GATE/EXPANDER/DE-ESSER areas for each module on the Home Screen to open these screens.

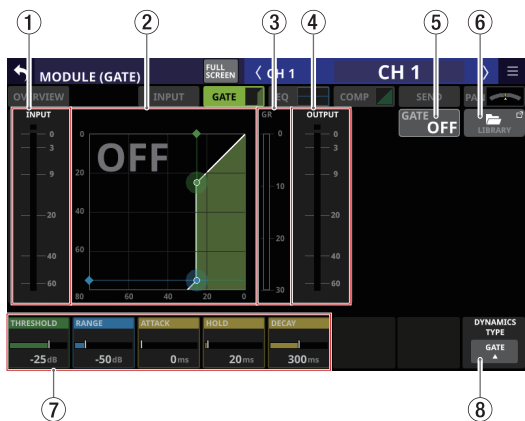

① INPUT level meter

This shows the signal level input to the GATE/EXPANDER/DE-ESSER.

② Dynamics input/output characteristics graph

This shows a graph of the GATE/EXPANDER input/output response or of the DE-ESSER EQ frequency response.

③ Gain reduction meter

This meter shows the amount of gain reduction from the GATE/EXPANDER/DE-ESSER.

④ OUTPUT level meter

This shows the signal level output from the GATE/EXPANDER/DE-ESSER.

⑤ GATE/EXPANDER/DE-ESSER ON/OFF button

- Tap this button to turn the dynamics effect on/off. (Default: OFF)
- When on, this button, the dynamics input/output response graph and parameters will appear highlighted.
- When off, a large “OFF” will appear in the top left of the dynamics input/output response graph area (②).

⑥ LIBRARY button

Tap this button to open the GATE/EXPANDER/DE-ESSER LIBRARY Screen. (See “Various LIBRARY Screens” on page 182.)

⑦ Dynamics Parameters

These show GATE/EXPANDER/DE-ESSER parameters and can be used to adjust them.

Use the LCD knobs that correspond to the parameters to adjust their values.

⑧ DYNAMIC TYPE button

- This shows the name of the currently selected dynamics type.
- Tap this button to open the type selection menu.

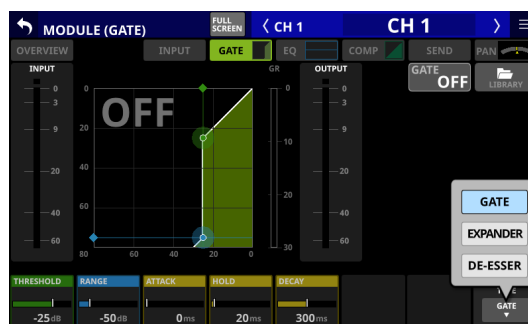

Options: GATE (default), EXPANDER, DE-ESSER

Dynamics parameters

NOTE

Turn the LCD knobs to adjust them. They can also be adjusted by dragging the green and blue ◆ and ● icons on the graph.

GATE

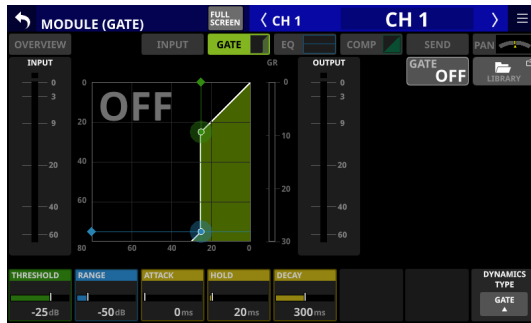

| Parameter name | Range | default |
|----------------|---------------|---------|
| THRESHOLD | -80 dB – 0 dB | -25 dB |
| RANGE | -60 dB – 0 dB | -50 dB |
| ATTACK | 0 ms – 125 ms | 0 ms |
| HOLD | 0 ms – 990 ms | 20 ms |
| DECAY | 5 ms – 5.00 s | 300 ms |

EXPANDER

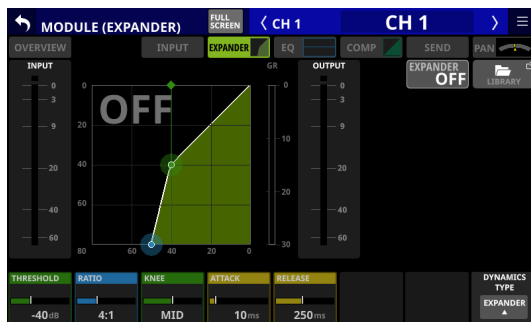

| Parameter name | Range | default |
|----------------|--------------------------------------|---------|
| THRESHOLD | -60 dB – 0 dB | -40 dB |
| RATIO | 1:1, 2:1, 4:1, 8:1, 16:1, 32:1, 64:1 | 4:1 |
| KNEE | HARD, MID, SOFT | MID |
| ATTACK | 0 ms – 125 ms | 10 ms |
| RELEASE | 5 ms – 5.00 s | 250 ms |

DE-ESSER

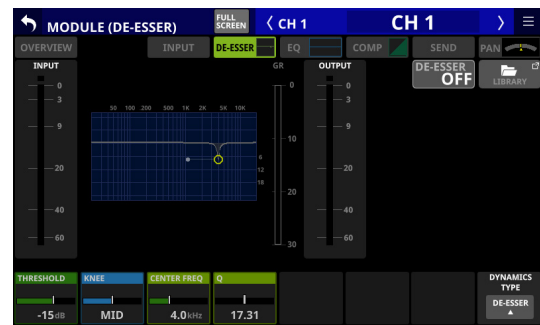

| Parameter name | Range | default |
|----------------|------------------|---------|
| THRESHOLD | -40 dB – 0 dB | -15 dB |
| KNEE | HARD, MID, SOFT | MID |
| CENTER FREQ | 1.0 kHz – 10 kHz | 4.0 kHz |
| Q | 1.04 – 17.31 | 17.31 |

NOTE

The peak position of this DE-ESSER EQ graph shows the maximum gain reduction amount. Moreover, this DE-ESSER operates at a 2:1 ratio.

For this reason, the peak position range of the EQ graph is -20 dB – 0 dB, which is half the Threshold range of -40 dB – 0 dB.

6 – Modules

MODULE (EQ) Screen

HPF (CH 1–40 only) and EQ settings can be made on the MODULE (EQ) Screen for every module.

Tap the module EQ area on the Home Screen to open this screen.

The colors of the parameters and points on the EQ graph are as follows.

LO band: red, LM band: yellow, HM band: green, HI band, light blue

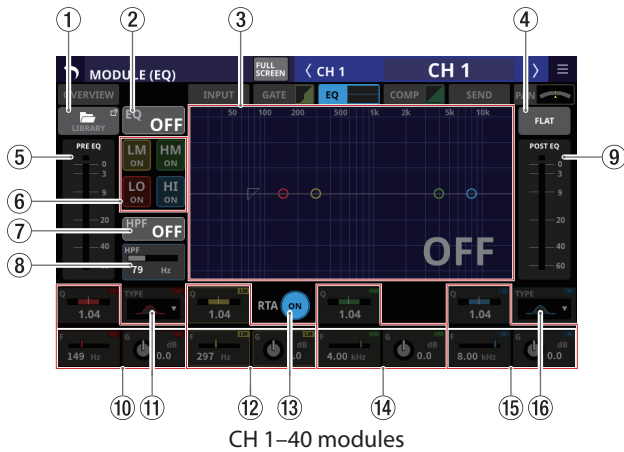

CH 1–40 modules

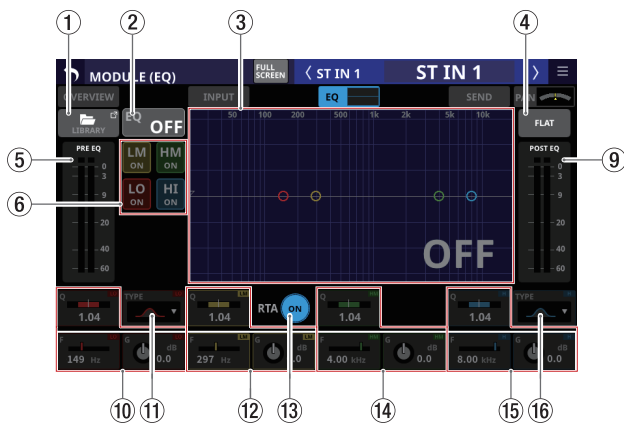

ST IN 1–2 modules

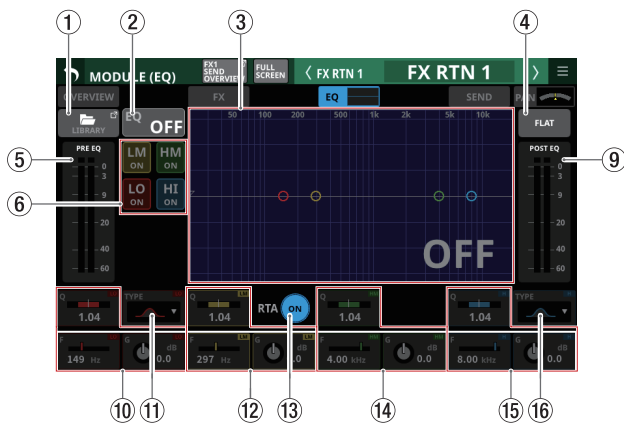

FX RTN 1–4 module

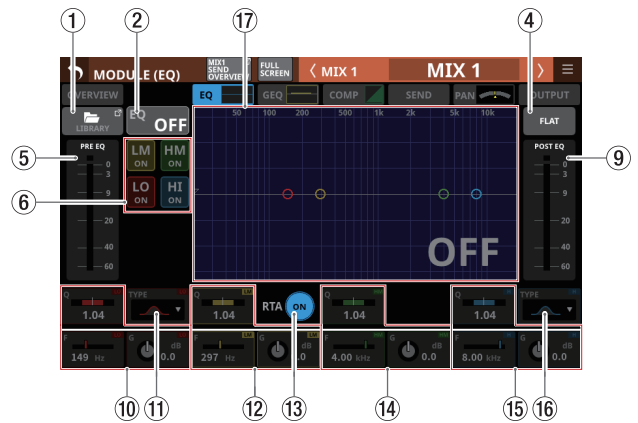

MIX 1–22 modules

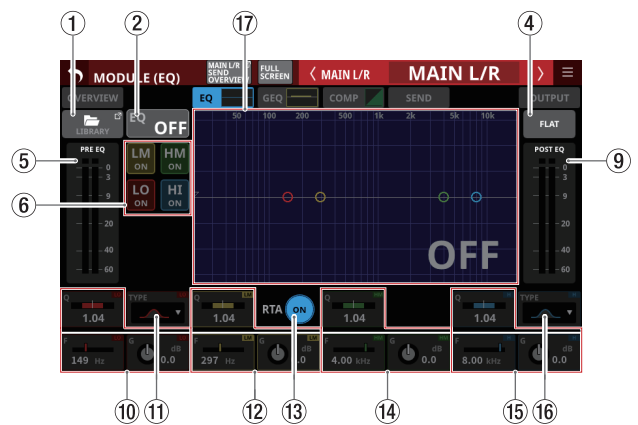

MAIN L/R Master module

① LIBRARY button

Tap this button to open the EQ LIBRARY Screen. (See “Various LIBRARY Screens” on page 182.)

② EQ ON/OFF button

Tap this button to turn the EQ on/off. (Default: OFF)
When on, this button, the EQ part of the HPF/EQ frequency response graph and the EQ parameters will appear highlighted.

NOTE

HPF is only shown for CH 1–40 modules.

③ HPF/EQ frequency response graph

- This shows graphs of the HPF and EQ frequency responses. This shows the overall frequency response. RTA bar meters are also shown.
- When HPF and EQ are on, this will appear highlighted.
- When HPF and EQ are off, this will appear gray.
- When only HPF or EQ is on, the frequency response of that function will be highlighted.
- By tapping , , , or in the frequency response graph and then dragging it, the GAIN or FREQ of that band can be adjusted. In addition, by dragging left/right the ends of the bars extending from the for the selected band, the Q for that band can be adjusted.
- When EQ is off, a large “OFF” will appear in the bottom right of the graph area.

NOTE

HPF is only shown for CH 1–40 modules.

④ FLAT button

Tap this button to open a confirmation message for resetting the gain settings for all bands to 0 dB.

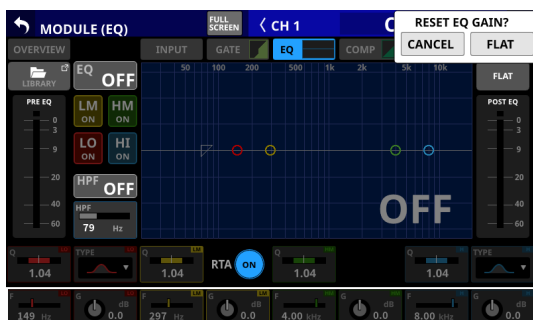

Tap the FLAT button to set the EQ gain settings to 0 dB. In addition, if the HI band TYPE was set to LPF, this will be changed to PEAK.

⑤ PRE EQ level meter(s)

This shows the signal levels input to the EQ.

⑥ EQ band ON/OFF buttons

Tap these buttons to turn the EQ bands on/off. (Default: ON)
When on, the setting for the corresponding band will be applied to the overall frequency response in the graph area.
When off, the corresponding parameter will appear gray. Moreover, the setting for the corresponding band will not be applied to the overall frequency response in the graph area. Instead, the frequency response of that band will be shown separately as a gray line.

⑦ HPF button (CH 1–40 modules only)

Tap this button to turn the HPF on/off. (Default: OFF)
When this is on, this button and the HPF part of the HPF/EQ frequency response graph will appear highlighted.

⑧ HPF frequency (CH 1–40 modules only)

This adjusts the cutoff frequency of the HPF.

Range: 20 Hz – 1.0 kHz (default: 79 Hz)

When the selection frame is shown, turn LCD knob 2 (lit blue) to adjust it.

⑨ POST EQ level meter(s)

This shows the level of the signal output from the EQ.

⑩ EQ parameters (LO band)

This shows the EQ LO band parameters and can be used to adjust them.

When the selection frame is shown, use the corresponding LCD knobs to adjust the values.

| Parameter name | Range | default |
|----------------|---------------------|---------|
| G | -18.0 dB – +18.0 dB | 0 dB |
| F | 20 Hz – 20.0 kHz | 149 Hz |
| Q | 0.10 – 17.31 | 1.04 |

NOTE

Tap the EQ gain area while pressing the HOME key on the top panel to set the EQ gain to 0 dB.

⑪ TYPE button (LO band)

- This shows the LO band EQ type.
- Tap this button to open the type selection menu.
Options: Bell (default), L.Shelf

⑫ EQ parameters (LM band)

This shows the EQ LM band parameters and can be used to adjust them.

When the selection frame is shown, use the corresponding LCD knobs to adjust the values.

| Parameter name | Range | default |
|----------------|---------------------|---------|
| G | -18.0 dB – +18.0 dB | 0 dB |
| F | 20 Hz – 20.0 kHz | 297 Hz |
| Q | 0.10 – 17.31 | 1.04 |

NOTE

Tap the EQ gain area while pressing the HOME key on the top panel to set the EQ gain to 0 dB.

⑬ RTA button

Tap this button to turn the real-time analyzer (RTA) function on/off for each touchscreen separately. (Default: ON)
When this is on, the button becomes highlighted, and audio signal frequency response meters for the PRE FADER position of input modules or POST FADER position of output modules are shown behind the EQ response graph.

NOTE

- RTA meters can be shown on up to three screens at the same time. For this reason, when using a Sonicview 24 that has three touchscreens and the TASCAM Sonicview Control application, RTA ON/OFF states will be switched automatically according to the following rules.
 - When all three Sonicview 24 touchscreens are showing EQ or GEQ with RTA ON, if RTA is switched from OFF to ON for the EQ or GEQ screen in the TASCAM Sonicview Control application, RTA will turn OFF automatically on the Sonicview 24 EQ or GEQ screen for which RTA was switched ON first.
 - In the above state, if a Sonicview 24 EQ or GEQ screen RTA is switched from OFF to ON, the TASCAM Sonicview Control application EQ or GEQ screen RTA will be switched OFF automatically.
- When using a Sonicview 16 that has two touchscreens with the TASCAM Sonicview Control application, the maximum number of EQ and GEQ screens at one time is three, so this type of automatic switching will not occur.

⑭ EQ parameters (HM band)

This shows the EQ HM band parameters and can be used to adjust them.

When the selection frame is shown, use the corresponding LCD knobs to adjust the values.

| Parameter name | Range | default |
|----------------|---------------------|---------|
| G | -18.0 dB – +18.0 dB | 0 dB |
| F | 20 Hz – 20.0 kHz | 4.0 kHz |
| Q | 0.10 – 17.31 | 1.04 |

NOTE

Tap the EQ gain area while pressing the HOME key on the top panel to set the EQ gain to 0 dB.

6 – Modules

15 EQ parameters (HI band)

This shows the EQ HI band parameters and can be used to adjust them.

When the selection frame is shown, use the corresponding LCD knobs to adjust the values.

| Parameter name | Range | default |
|----------------|---------------------|---------|
| G | -18.0 dB – +18.0 dB | 0 dB |
| F | 20 Hz – 20.0 kHz | 8.0 kHz |
| Q | 0.10 – 17.31 | 1.04 |

NOTE

Tap the EQ gain area while pressing the HOME key on the top panel to set the EQ gain to 0 dB.

16 TYPE button (HI band)

- This shows the HI band EQ type.
- Tap this button to open the type selection menu.
Options: Bell (default), H.Shelf, LPF

17 EQ/GEQ frequency response graph

- This shows graphs of the EQ and GEQ frequency responses. This shows the overall frequency response. RTA bar meters are also shown.
- When EQ and GEQ are on, a graph of their sound responses will be shown highlighted.
- When EQ and GEQ are off, the response graph for EQ without GEQ will be shown and appear gray.
- When EQ is on and GEQ is off, the response graph for EQ only will be shown highlighted.
- When EQ is off and GEQ is on, the response graph for EQ only will be gray and the response graph for GEQ only will be shown highlighted.

MODULE (GEQ) Screen

GEQ settings can be made on the MODULE (GEQ) Screens for MIX 1–22 and MAIN L/R Master modules.

Tap the module GEQ area on the Home Screen to open this screen.



MIX 1–22 MODULE (GEQ) Screen with GEQ off

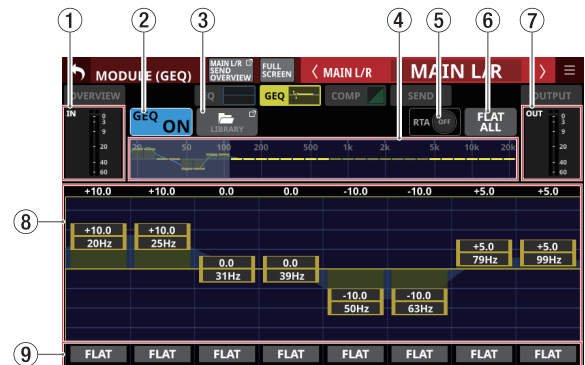

MAIN L/R Master MODULE (GEQ) Screen with GEQ on

1 IN level meters

This shows signal level input to the GEQ.

2 GEQ ON/OFF button

Tap this button to turn the GEQ on/off.

When this is on, this button, the GEQ overall settings graph (4) and the GEQ setting display area (8) will appear highlighted.

3 LIBRARY button

Tap this button to open the GEQ LIBRARY Screen. (See “Various LIBRARY Screens” on page 182.)

④ GEQ overall setting graph

- This shows the gain settings of all 31 GEQ bands.
- This shows RTA bar meters.
- The range of bands that can be operated by LCD knobs are shown with a white rectangle.
- This shows the overall frequency response of the EQ and GEQ.
 - When EQ and GEQ are on, a graph of their sound responses will be shown highlighted.
 - When EQ and GEQ are off, the response graph will not be shown.
 - When EQ is on and GEQ is off, the response graph for EQ only will be shown highlighted.
 - When EQ is off and GEQ is on, the response graph for GEQ only will be shown highlighted.

⑤ RTA button

Tap this button to turn the real-time analyzer (RTA) function on/off for each touchscreen separately. (Default: ON)
When this is on, the button becomes highlighted, and audio signal frequency response meters for the POST FADER position are shown behind the GEQ overall setting graph (④) and the GEQ setting for the range of bands that can be operated by LCD knobs (⑧).

NOTE

- RTA meters can be shown on up to three screens at the same time. For this reason, when using a Sonicview 24 that has three touchscreens and the TASCAM Sonicview Control application, RTA ON/OFF states will be switched automatically according to the following rules.
 - When all three Sonicview 24 touchscreens are showing EQ or GEQ with RTA ON, if RTA is switched from OFF to ON for the EQ or GEQ screen in the TASCAM Sonicview Control application, RTA will turn OFF automatically on the Sonicview 24 EQ or GEQ screen for which RTA was switched ON first.
 - In the above state, if a Sonicview 24 EQ or GEQ screen RTA is switched from OFF to ON, the TASCAM Sonicview Control application EQ or GEQ screen RTA will be switched OFF automatically.
- When using a Sonicview 16 that has two touchscreens with the TASCAM Sonicview Control application, the maximum number of EQ and GEQ screens at one time is three, so this type of automatic switching will not occur.

⑥ FLAT ALL button

Tap this button to open a confirmation message for resetting the gain settings for all GEQ frequencies to 0 dB.

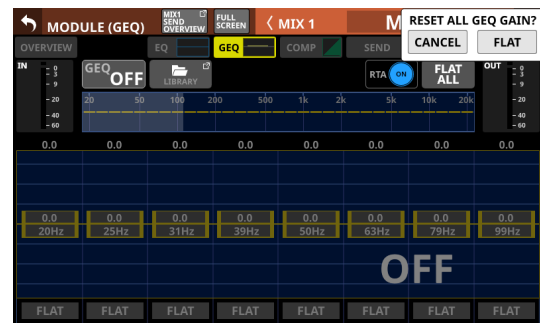

Tap the FLAT button to set all band gain settings to 0 dB.

⑦ OUT level meters

This shows the level of the signal output from the GEQ.

⑧ Range of GEQ band settings that can be controlled by LCD knobs

- The range of gain settings in bands selected for operation by LCD knobs is shown. The range of bands that can be operated by LCD knobs can be selected by touching the GEQ overall setting graph (④). Adjust gain values by dragging the yellow sliders in the display area up and down or using the LCD knobs.
- This shows RTA bar meters.
- This shows the overall frequency response of the EQ and GEQ.
 - When EQ and GEQ are on, a graph of their sound responses will be shown highlighted.
 - When EQ and GEQ are off, the response graph will not be shown.
 - When EQ is on and GEQ is off, the response graph for EQ only will be shown highlighted.
 - When EQ is off and GEQ is on, the response graph for GEQ only will be shown highlighted.
 - When GEQ is off, a large "OFF" will appear in the bottom right of the area.

⑨ FLAT buttons

Tap these buttons to set gain settings for corresponding bands to 0 dB.

6 – Modules

MODULE (COMP/DUCKER) Screen

COMP and DUCKER settings can be made on the MODULE (COMP) and MODULE (DUCKER) Screens for CH 1–40, MIX 1–22 modules and MAIN L/R Master modules.

Tap the COMP/DUCKER area on the Home Screen to open this screen.

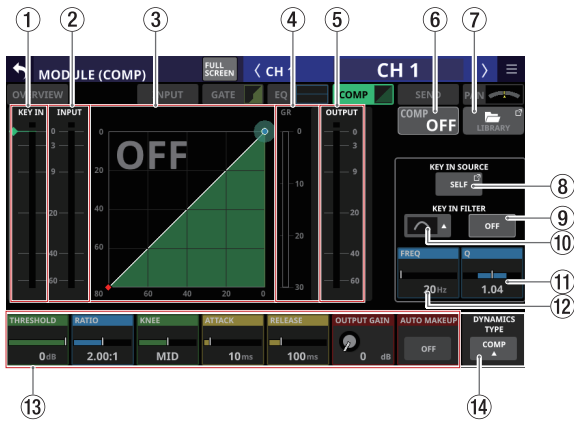

CH 1–40 modules

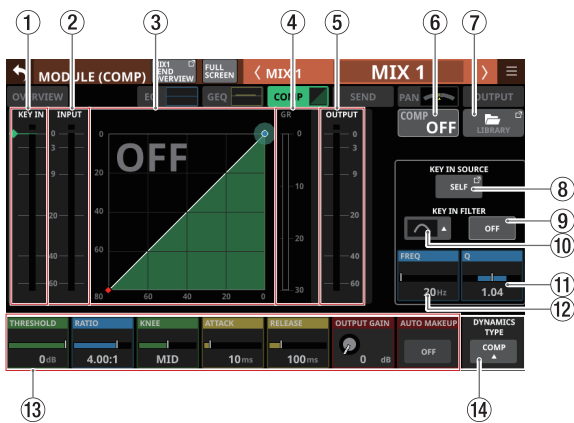

MIX 1–22 modules

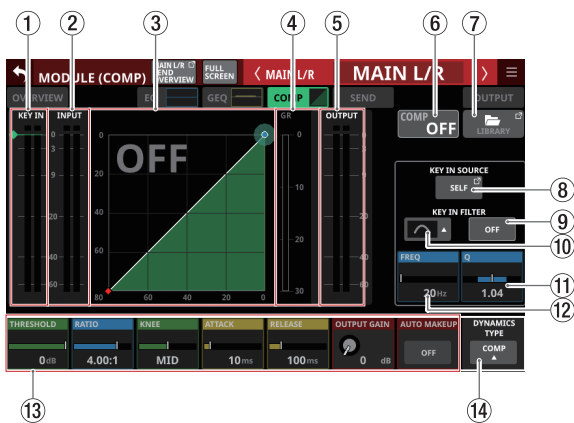

MAIN L/R Master module

① KEY IN level meter(s)

This shows the KEY IN SOURCE level input to the COMP/DUCKER.

NOTE

- If the module is stereo and the KEY IN SOURCE module is stereo, a stereo level meter will be shown.
- If the module is mono and the KEY IN SOURCE module is stereo, a mono level meter will be shown, and the L+R mono level will be used as the trigger.

② INPUT level meter(s)

This shows the signal level(s) of the selected module input to the COMP/DUCKER.

③ Dynamics input/output characteristics graph

This shows graphs of the COMP/DUCKER input/output response.

④ Gain reduction meter

This meter shows the amount of gain reduction from the COMP/DUCKER.

⑤ OUTPUT level meter(s)

This shows the level(s) of the signal(s) output from the COMP/DUCKER.

⑥ COMP/DUCKER ON/OFF button

Tap this button to turn the dynamics effect on/off. (Default: OFF)

When on, this button, the dynamics input/output response graph and parameters will appear highlighted.

When off, a large “OFF” will appear in the top left of the dynamics input/output response graph area (③).

⑦ LIBRARY button

Tap this button to open the COMP/DUCKER LIBRARY Screen. (See “Various LIBRARY Screens” on page 182.)

⑧ KEY IN SOURCE button

• This shows the name of the selected KEY IN source. (Default: SELF)

• Tap this button to open the KEY IN SOURCE SELECT Screen. (See “KEY IN SOURCE SELECT screen” on page 144.)

⑨ KEY IN FILTER button

Tap this button to turn KEY IN FILTER on/off. (Default: OFF)

⑩ KEY IN FILTER TYPE button

• This shows the KEY IN FILTER type.

• Tap this button to open the type selection menu.

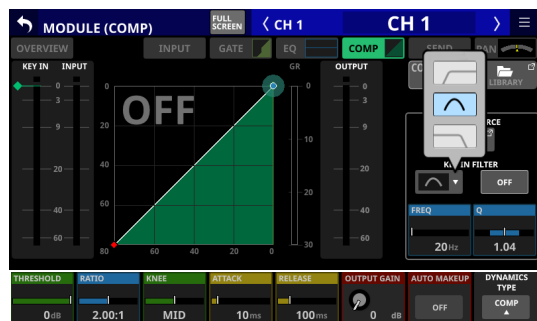

Options: HPF, BPF (default), LPF

11 Q

This adjusts the Q value when the KEY IN FILTER type is bandpass.

Range: 0.1 – 17.31 (default: 1.04)

When the selection frame is shown, turn LCD knob 8 (lit light blue) to adjust it.

12 FREQ

This adjusts the KEY IN FILTER frequency.

Range: 20 Hz – 20 kHz (default: 20 Hz)

When the selection frame is shown, turn LCD knob 7 (lit light blue) to adjust it.

13 Dynamics parameters

These show COMP/DUCKER parameters and can be used to adjust them.

When a selection frame is shown, use the corresponding LCD knobs and buttons to change settings.

14 DYNAMICS TYPE button

- This shows the name of the currently selected dynamics type. (Default: COMP)
- Tap this area to open the type selection menu.

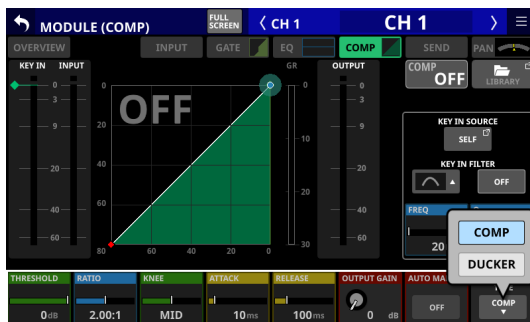

Options: COMP (default), DUCKER

Dynamics parameters

NOTE

Use the corresponding LCD knobs and buttons to change the settings. They can also be adjusted by dragging the green and blue ◆ and ● icons on the graph.

COMP

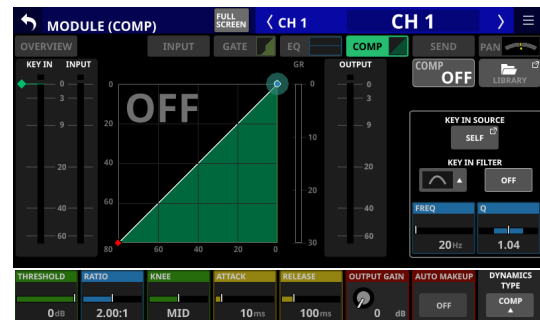

| Parameter name | Range | default |
|----------------|---|--|
| THRESHOLD | -49 dB – 0 dB | -10 dB |
| RATIO | 1.00:1 – ∞:1 | 2.50:1 |
| KNEE | HARD, HARD MID, MID, SOFT MID, SOFT, SMOOTH | CH 1–40: MID MIX 1–22, MAIN L/R: SMOOTH |
| ATTACK | 0.1 ms – 125 ms | 30 ms |
| RELEASE | 5 ms – 5.00 s | 230 ms |
| OUTPUT GAIN | 0 dB – +20 dB | 0 dB |
| AUTO MAKEUP | OFF, ON | OFF |

DUCKER

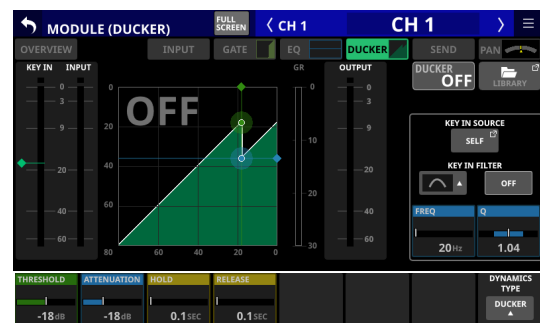

| Parameter name | Range | default |
|----------------|---|---------|
| THRESHOLD | -30 dB, -24 dB, -18 dB, -12 dB, -6 dB | -18 dB |
| ATTENUATE | -∞, -24 dB, -18 dB, -12 dB, -9 dB, -6 dB, -3 dB | -18 dB |
| HOLD | 0.1sec – 5.0sec | 1.0 sec |
| RELEASE | 0.1sec – 5.0sec | 3.0 sec |

6 – Modules

KEY IN SOURCE SELECT screen

Tap the KEY IN SOURCE button on the MODULE (COMP) or MODULE (DUCKER) Screen to open this screen. The COMP/DUCKER KEY IN source can be selected with the following buttons.

- SELF (default)
- CH 1–40
- MIX 1–22
- MAIN L/R

The selected button will be highlighted.

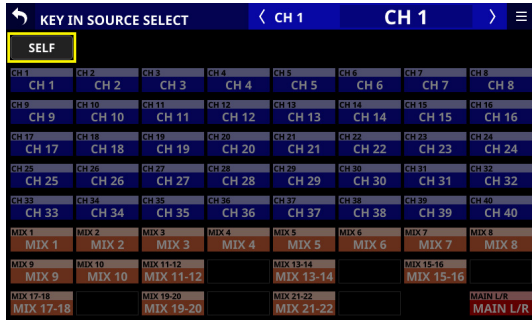

NOTE

- When the DYNAMICS TYPE is Comp, the KEY IN SOURCE is the Pre Comp signal.
- When the DYNAMICS TYPE is DUCKER, the KEY IN SOURCE is the POST Fader/MUTE signal.

MODULE (SEND/PAN) Screen

The following settings can be made on the MODULE (SEND/PAN) Screen.

- SEND level, SEND PAN, ON/OFF, PRE/POST to MIX 1–22 buses
- SEND level, ON/OFF, PRE/POST to FX 1–4 buses
- PAN/BAL
- MAIN L/R bus assignments

The following settings can also be made for CH 1–40 modules when Stereo Link is on, and for ST IN 1–2 and FX RTN 1–4 modules.

- MODE
- IMAGE

Tap the following areas for each module on the Home Screen to open this screen.

- SEND/PAN button
- PAN/BAL area with selection frame shown

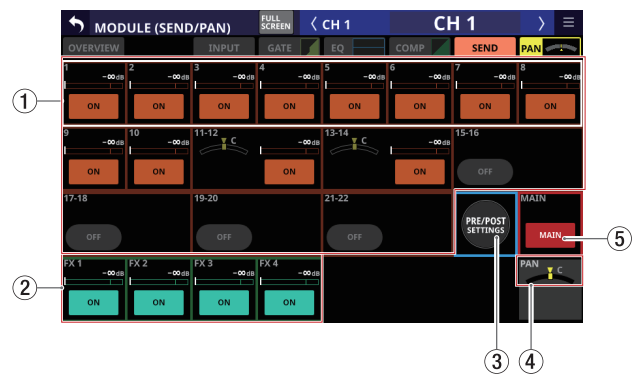

CH 1–40 modules

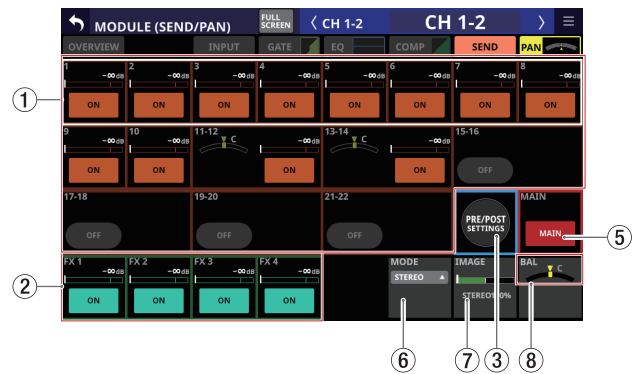

CH 1–40 modules with Stereo Link on

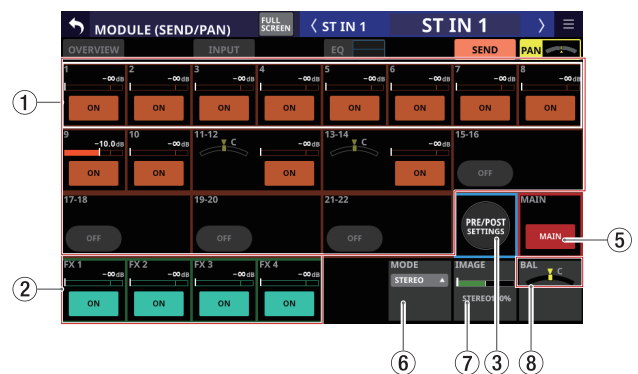

ST IN 1–2 modules

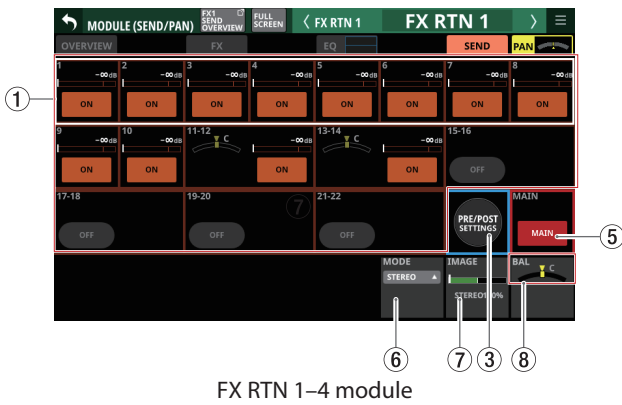

FX RTN 1-4 module



MIX 1-22 modules

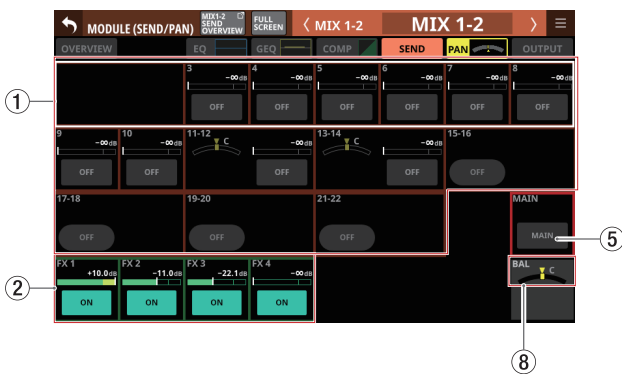

MIX 1-22 modules with Stereo Link on



MAIN L/R Master module

① SEND levels, SEND PAN and ON/OFF buttons for MIX 1-22 buses

This shows the SEND settings for MIX 1-22 buses.

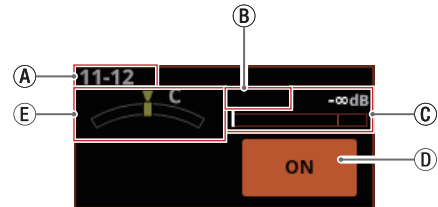
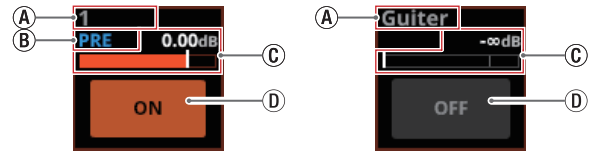

- ① This shows the user module names for the MIX 1-22 modules. If the name has not been defined, the MIX module number, for example "1", will be shown.
- ② This shows the send position settings for the MIX 1-22 buses.

| | |
|--------------|-------------------|
| No indicator | Set to POST FADER |
| PRE | Set to PRE FADER |

- ③ Use this to adjust the send levels to the MIX 1-22 buses. When a selection frame is shown, use corresponding LCD knobs (lit orange) to adjust values.

| | |
|----------------|-----------------|
| Assignment on | Shown in orange |
| Assignment off | Shown in gray |

Range: $-\infty$ dB – +10 dB (default: $-\infty$ dB)

- ④ Tap this button to turn on/off signals sent to the MIX 1-22 buses.

| Module | default |
|------------------------------|---------|
| CH 1-40/ST IN 1-2/FX RTN 1-4 | ON |
| MIX 1-22/MAIN L/R Master | OFF |

- ⑤ This adjusts the SEND PAN of the signal sent to the MIX 1-22 buses. When a selection frame is shown, use corresponding LCD knobs (lit yellow) to adjust values.

Range: L100 – C – R100 (default: C)

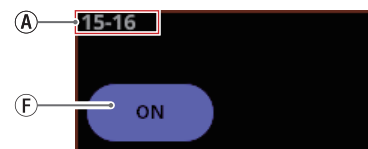

- ⑥ Rounded buttons are shown for MIX 1-22 modules set to GROUP buses. Tap this button to turn it on and off.

NOTE

- A list of SEND settings for each bus can be viewed and operated ("MIX 1-22 bus SEND OVERVIEW Screen" on page 153).
- Tap the SEND level area while pressing the HOME key on the top panel to set the SEND level for that bus to 0 dB.
- Tap the SEND PAN area while pressing the HOME key on the top panel to set the SEND PAN for the tapped bus to center (C).

6 – Modules

- When Stereo Link is on for a MIX 1–22 bus, the PAN status will be shown in the bus area of the lower number, and the level and button will be shown in the bus area of the higher number.
- SEND PAN parameters for buses with the PAN LINK setting on appear dim. Tapping them will not select them and they cannot be operated. They are linked to the PAN/BAL setting.
- When a MIX 1–22 module is selected, the SEND level and button to the same bus as the selected module are not shown.
- If a MIX 1–22 bus is already assigned to the MAIN L/R bus, trying to turn this MIX button on for the MAIN L/R Master module will produce an error message. To prevent a feedback loop, it cannot be turned on.

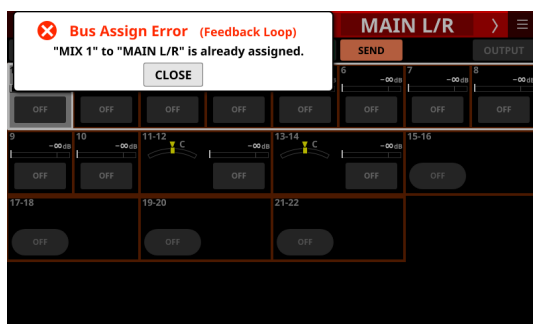

② SEND levels and ON/OFF buttons for FX 1–4 buses

This shows the SEND settings for FX 1–4 buses.

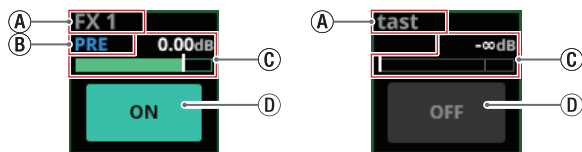

- Ⓐ This shows the user module names for the FX RTN 1–4 modules. If the name has not been defined, the module name will be shown as “FX 1”, for example.
- Ⓑ This shows the send position setting for the FX 1–4 bus.

| | |
|--------------|-------------------|
| No indicator | Set to POST FADER |
| PRE | Set to PRE FADER |

- Ⓒ Use this to adjust the send level to the FX 1–4 bus. When a selection frame is shown, use corresponding LCD knobs (lit green) to adjust values.

| | |
|----------------|----------------|
| Assignment on | Shown in green |
| Assignment off | Shown in gray |

Range: $-\infty$ dB – +10 dB (default: $-\infty$ dB)

- Ⓓ Tap this button to turn on/off the signal sent to the FX 1–4 bus.

Options: ON (default), OFF

NOTE

- This is not shown when the selected module is an FX RTN 1–4 or MAIN L/R Master module.
- A list of SEND settings for each bus can be viewed and operated (“FX 1–4 bus SEND OVERVIEW Screen” on page 156).
- Tap the SEND level area while pressing the HOME key on the top panel to set the SEND level for that bus to 0 dB.

③ PRE/POST SETTINGS button

Tap this button to highlight it, changing the ON/OFF button for each bus to a PRE/POST settings button.

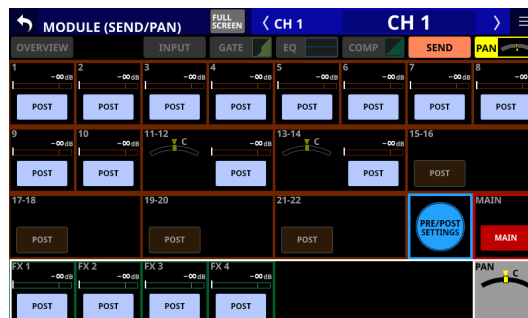

Tap each button to change the send positions to the MIX 1–22 and FX1–4 buses.

Options: PRE, POST (default)

NOTE

- This is only shown when the selected module is a CH 1–40, ST IN 1–2 or FX RTN 1–4 module.
- A list of PRE/POST settings can be viewed and operated for each bus on the PRE/POST (INPUT) Screen (See “MIX 1–22 bus SEND OVERVIEW Screen” on page 153 and “FX 1–4 bus SEND OVERVIEW Screen” on page 156.)

④ PAN indicator (shown for mono modules only)

This adjusts the pan of the signals sent to the MAIN L/R bus.

Range: L100 – C – R100 (default: C)

When the selection frame is shown, turn LCD knob 8 (lit yellow) to adjust it.

NOTE

- A list of PAN/BAL settings can be viewed and operated for the MAIN L/R bus on the SEND PAN (INPUT) and SEND PAN (BUS) screens (“MAIN L/R bus SEND OVERVIEW Screen” on page 158).
- When PAN settings are centered (C), signals are reduced by 3 dB and sent to both left and right MAIN MIX L/R buses.
- Tap this area while pressing the HOME key on the top panel to set the pan to center (C).

⑤ MAIN button

Tap this button to turn the assignment to the MAIN L/R bus on/off.

When this is on, the button will appear highlighted, and the signal will be sent to MAIN L/R bus.

| Module name | default |
|-------------|---------|
| CH 1–40 | On |
| ST IN 1–2 | On |
| FX RTN 1–4 | On |
| MIX 1–22 | Off |

NOTE

- A list of MAIN L/R bus assignment settings can be viewed and operated on the ON/OFF (INPUT) and ON/OFF (BUS) screens (“MAIN L/R bus SEND OVERVIEW Screen” on page 158).
- This is not shown when the selected module is the MAIN L/R Master module.
- If the MAIN L/R Master module is already assigned to the selected MIX 1–22 bus and on, trying to turn this button on for the MIX 1–22 module will produce the following error message. To prevent a feedback loop, it cannot be turned on.

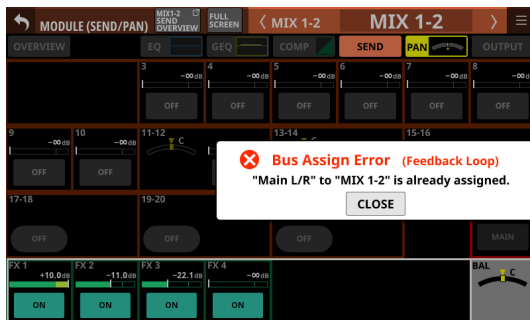

⑥ MODE

- This shows the selected setting.
- Tap this area to open a window where the setting can be selected to handle the stereo module input signal as a stereo signal or to handle either the left or right channel as a mono signal.

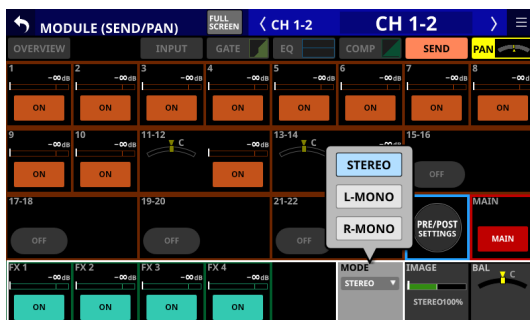

| Option | Meaning |
|------------------|--|
| STEREO (default) | Input the two input signals as a stereo signal to the module. |
| L-Mono | Input only the left signal of the two input signals as a mono signal to the module. |
| R-Mono | Input only the right signal of the two input signals as a mono signal to the module. |

NOTE

- This is only shown when the selected module is a CH 1–40 module with the Stereo Link setting on, or a ST IN 1–2 or FX RTN 1–4 module.
- If L-Mono or R-Mono is selected, the BAL setting will function as a PAN setting.

⑦ IMAGE

Use this to adjust the image width of the stereo signal. The farthest left produces ordinary stereo. Turning it right reduces the stereo width until the center where it becomes mono. Turning it further to the right reverses the stereo positions until left and right are completely reversed at the farthest right.

Range: STEREO 100% – MONO – REVERSE 100%
(default: STEREO 100%)

When the selection frame is shown, turn LCD knob 7 (lit green) to adjust it.

NOTE

This is only shown when the selected module is a CH 1–40 module with the Stereo Link setting on, or a ST IN 1–2 or FX RTN 1–4 module.

⑧ BAL indicator (shown for stereo modules only)

This adjusts the balance of the signals sent to the MAIN L/R bus.

Range: L100 – C – R100 (default: C)

When the selection frame is shown, turn LCD knob 8 (lit yellow) to adjust it.

NOTE

- A list of PAN/BAL settings can be viewed and operated for the MAIN L/R bus on the SEND PAN (INPUT) and SEND PAN (BUS) Screen (“MAIN L/R bus SEND OVERVIEW Screen” on page 158).
- This is not shown when the selected module is the MAIN L/R Master module.
- When BAL settings are centered (C), the left channel is sent to the MAIN L bus and the right channel is sent to the MAIN R bus at 0 dB.
- Tap this area while pressing the HOME key on the top panel to set the balance to center (C).

6 – Modules

MODULE (OUTPUT) Screen

Module output settings can be made on the MODULE (OUTPUT) Screens for MIX 1–22 and MAIN L/R Master modules.

Tap the OUTPUT area at the top of the Home Screen of a MIX 1–22 or MAIN L/R Master module to open this screen.

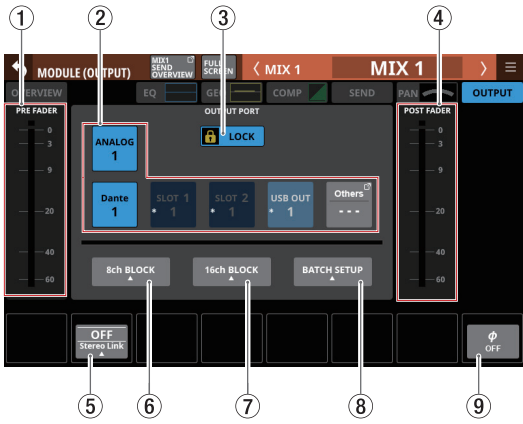

MIX 1–22 modules

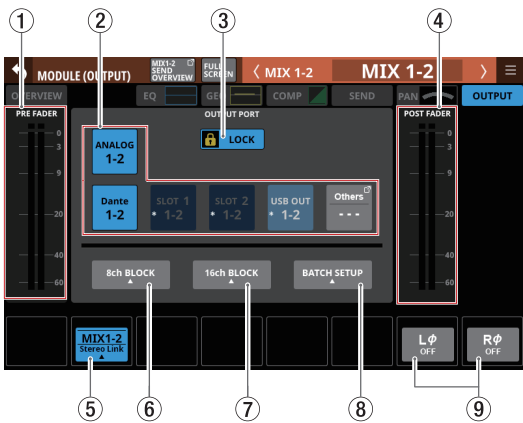

MIX 1–22 modules with Stereo Link on

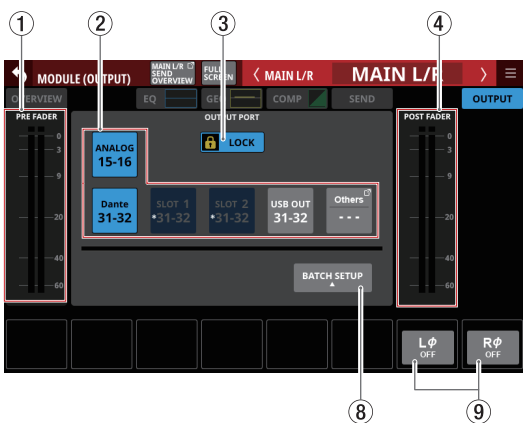

MAIN L/R Master module

① **PRE FADER level meter(s)**

This shows PRE FADER signal level(s).

② **OUTPUT PORT selection buttons**

- When the LOCK/UNLOCK button (③) is set to “UNLOCK”, tap these buttons to select the signal output port of the selected module. The selected output port button will be highlighted. If a selection button that already has another output signal assigned to it (shown by *) is tapped, a setting change confirmation message will open. Tapping the OK button on the confirmation message will change the setting and close the message. Tapping the CANCEL button on the confirmation message will close the message without changing the setting.

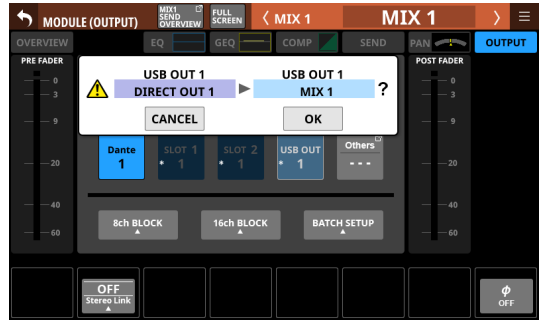

- If a Dante port that has a mounted SB-16D assigned is selected, “SB #[ID] [port number]” will be shown.



If it is a virtually-mounted SB-16D, (V) will appear to the top right.



- Assigned buttons for Dante ports that have virtually-mounted SB-16Ds will be highlighted yellow.



- If the selected output port is not shown on one of the main buttons, the output port name will be shown on the Others button.

- If the module is stereo and output port that are not left-right adjacent are selected, output port names will appear split left and right and abbreviated as follows on the Others button.

| Module name shown | Stereo module name shown |
|-------------------|--------------------------|
| ANALOG | AN |
| Dante | DA |
| SLOT 1 | S1 |
| SLOT 2 | S2 |
| USB OUT | USB |



- Tap the Others button to open the OUTPUT PORT SELECT Screen. (See “OUTPUT PORT SELECT screen” on page 112.)
- The signal from a single module can be assigned to multiple output ports.

③ LOCK/UNLOCK button

- This button locks/unlocks routing setting change operations for the unit. This is always locked at the time of start up.
- When set to “LOCK”, tapping the OUTPUT PORT selection button (②) will not change settings. Furthermore, the 8ch BLOCK, 16ch BLOCK and BATCH SETUP buttons will also be disabled. However, tapping the Others button and switching to the OUTPUT PORT SELECT Screen is possible.
- When set to “LOCK”, tap this button to open a confirmation message. Tap the UNLOCK button to close the message and set it to “UNLOCK”. Tapping the CANCEL button on the confirmation message will close it and maintain the locked state.

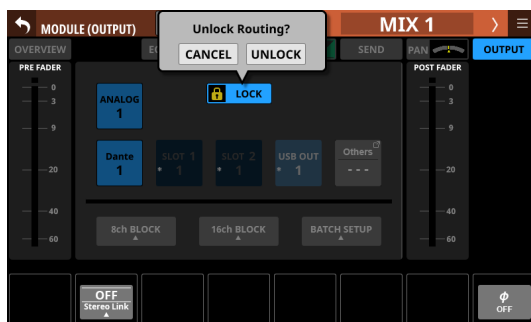

- Tap this button when set to “UNLOCK” to switch it to “LOCK”.

NOTE

The LOCK/UNLOCK button (①) setting is shared by the following routing setting screens.

- MODULE (INPUT) Screen
- MODULE (OUTPUT) Screen
- INPUT SOURCE SELECT Screen
- OUTPUT PORT SELECT Screen
- DIRECT OUT PORT SELECT Screen
- INSERT SEND PORT SELECT Screen
- INSERT RETURN PORT SELECT Screen

④ POST FADER level meter(s)

This shows POST FADER signal level(s).

⑤ Stereo Link button (MIX 1–22 modules only)

- These show the stereo link setting states of the MIX 1–22 modules.

| | |
|--|-----------------------|
| | Stereo linking is off |
| | Stereo linking is on |

- Tap this button to open the Stereo Link setting window.

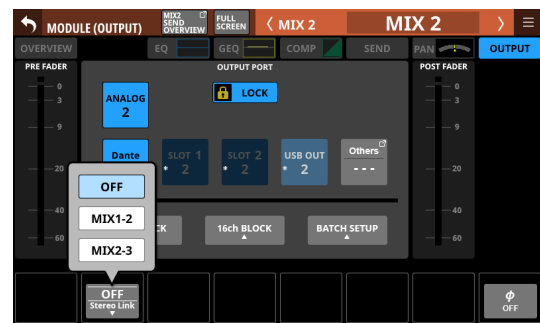

Linking with either module to the left or right is possible except for MIX 1 and MIX 22.

⑥ 8ch BLOCK button (MIX 1–22 modules only)

When the LOCK/UNLOCK button (③) is set to “UNLOCK”, tap this button to open a window where the output ports of 8 channels can be set at the same time. (See “Setting output ports for multiple channels at the same time” on page 105.) Change settings for multiple designated channels at the same time.

⑦ 16ch BLOCK button (MIX 1–16 modules only)

When the LOCK/UNLOCK button (③) is set to “UNLOCK”, tap this button to open a window where the output ports of 16 channels can be set at the same time. (See “Setting output ports for multiple channels at the same time” on page 105.) Change settings for multiple designated channels at the same time.

⑧ BATCH SETUP button

When the LOCK/UNLOCK button (③) is set to “UNLOCK”, tap this button to open a BATCH SETUP window where the output ports of a range of channels can be set at the same time. (See “Setting output ports for multiple channels at the same time in batches” on page 106.)

Change settings for multiple designated channels at the same time.



6 – Modules

⑨ Phase button(s)





Use these to change the phases of the signals for the selected module.

Tap these buttons to reverse the phases of the selected module signals.

- Phase button display when the Stereo Link setting is off for the selected module

| | |
|---|----------|
|  | Normal |
|  | Reversed |

- Phase button display when the selected module is stereo

| | |
|---|----------|
|   | Normal |
|   | Reversed |

MODULE menu

MODULE menu operations

- Tap the  button at the top right of the MODULE screen to open the MODULE menu for the selected module.
- Scrollbars appear when all selectable items cannot be shown in the MODULE menu at the same time. In this case, drag the menu up and down to scroll the items.

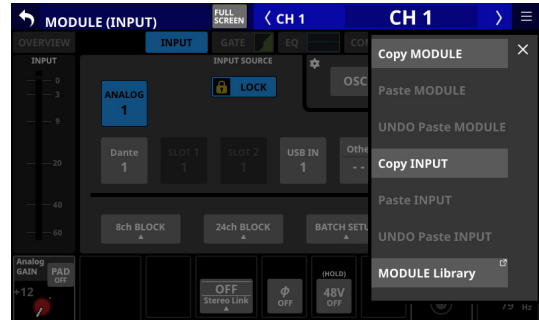

- Tap the MODULE menu  button or the  button to close the menu.

MODULE menu items

| Menu item | Function |
|-------------------|--|
| Copy MODULE | This copies all the parameter setting values of the selected module into a buffer. |
| Paste MODULE | This pastes all the parameter setting values copied into the buffer to the selected module. |
| UNDO Paste MODULE | This undoes pasting to the selected module. |
| REDO Paste MODULE | This redoes pasting to the selected module. |
| Copy INPUT | This copies all the parameter setting values on the <u>MODULE (INPUT)</u> Screen of the selected module into a buffer. |
| Paste INPUT | This pastes all the <u>MODULE (INPUT)</u> Screen parameter setting values copied into the buffer to the selected module. |
| UNDO Paste INPUT | This undoes pasting to the <u>MODULE (INPUT)</u> Screen of the selected module. |
| REDO Paste INPUT | This redoes pasting to the <u>MODULE (INPUT)</u> Screen of the selected module. |
| MODULE Library | Tap this area to open the LIBRARY Screen for the selected module. |

NOTE

- The underlined words in the menu item list will be replaced with the MODULE screen names of the selected module.
- The menu items with underlined words are not shown on the MODULE (OVERVIEW) and MODULE (OUTPUT) screens.
- The following parameters cannot be copied or pasted.
 - Input Routing
 - OSC Input
 - Output Port Assign*
 - Insert Send Port Assign*
 - Insert Return Port Assign*
 - Insert ON/OFF*
 - Direct Out Port Assign*

* Output ports cannot be used by multiple modules at the same time. These parameters are excluded from copying and pasting because doing so would change the output settings of other modules along with the paste destination.

Pasting Pre Amp parameters

Left and right Pre Amp parameters can be set independently even for stereo modules.

If the mono/stereo states of the copy source and paste destinations are different, the following will happen.

- If the copy source is a mono module and the paste destination is a stereo module, the copy source Pre Amp data will be pasted to both the L and R Pre Amp settings of the paste destination.
- If the copy source is a stereo module and the paste destination is a mono module, the L channel Pre Amp data of the copy source will be pasted to the Pre Amp settings of the paste destination.

Pasting phase parameters

Phase parameters can be set independently for the left and right channels of stereo modules.

If the mono/stereo states of the copy source and paste destinations are different, the following will happen.

- If the copy source is a mono module and the paste destination is a stereo module, the copy source phase data will be pasted to $L\varphi$ and $R\varphi$ of the paste destination.
- If the copy source is a stereo module and the paste destination is a mono module, the $L\varphi$ data of the copy source will be pasted to the φ of the paste destination.

Pasting MODE/IMAGE parameters

MODE/IMAGE parameters shown on the MODULE (SEND/PAN) screen only exist for stereo input modules. (See "MODULE (SEND/PAN) Screen" on page 144.)

For this reason, MODE/IMAGE parameters can only be copied and pasted when both the source and destination are stereo input modules.

7 – Other module parameter setting screens

SENDS ON FADER function

- The SENDS ON FADER function enables controlling SEND levels with faders.
- When in Sends On Fader mode, the SENDS ON FADER on the top panel lights and the following operations are possible.
 - Using channel faders to control SEND levels from each module to buses subject to SENDS ON FADER operation
 - Using the MASTER fader to control the FADER level (bus master level) of buses subject to SENDS ON FADER operation
 - Using channel MUTE keys to switch SEND ON/OFF to buses subject to SENDS ON FADER operation from each module (MUTE key lit: SEND OFF, MUTE key unlit: SEND ON)

In addition, the MUTE, SOLO and SEL keys and the color bar in the top panel master section will become operation keys and displays for the bus subject to SENDS ON FADER operation. The SEND indicator will also light and the L/R indicators will become unlit.

- Sends On Fader mode can be activated and deactivated with the following operations.
 - Top panel SENDS ON FADER key
 - USER KEY/FOOTSWITCH/GPIO-IN assigned to the Sends On Fader function (See “USER DEFINED CONTROLS screen” on page 44.)

NOTE

The Sends On Fader mode setting is assigned to the following USER KEYS by default on the User Key page.

- USER KEY 5–12 (Sends On Fader Mix1–8)

SENDS ON FADER screen

Select the buses subject to SENDS ON FADER operation on this screen

Press the SENDS ON FADER key on the top panel to open this screen.

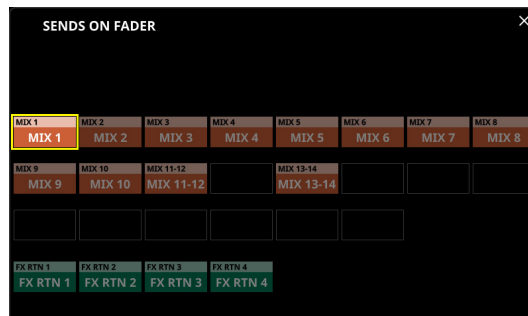

- Tap a bus selection button, highlighting it, to select that bus. The channel faders will move to the positions of the SEND levels from the modules to the selected buses. The MASTER fader will move to the position of the FADER level of the selected bus. The channel MUTE keys will be lit/unlit according to the SEND ON/OFF status to the selected bus of each module (MUTE key lit: SEND OFF, MUTE key unlit: SEND ON).
- To use SENDS ON FADER operation while, for example, the Home Screen on the right touchscreen is open, tap the icon at the top right of this screen to close it.
- Tapping the icon will close this window, but Sends On Fader mode will remain active. Press the SENDS ON FADER key to open the SENDS ON FADER Screen again.
- Press SENDS ON FADER key when the SENDS ON FADER screen is open to end Sends On Fader mode. This will close the SENDS ON FADER screen and return these items to their normal display states: channel faders and mute buttons, MASTER faders, master section MUTE, SOLO and SEL keys and color bars, L/R SEND indicators and channel screens.

NOTE

This screen will not be shown for a MIX bus with BUS mode set to GROUP.

7 – Other module parameter setting screens

SEND OVERVIEW screen

SEND parameters for the selected bus (MIX 1–22, FX 1–4 or MAIN L/R) are shown in a list and can be operated.

The MODULE (SEND/PAN) Screen shows a list of the SEND parameters (B) aligned vertically on the analog mixer, and can be used to operate them.

In contrast, the SEND OVERVIEW Screen shows a list of the SEND parameters (A) aligned horizontally on the analog mixer, and can be used to operate them.

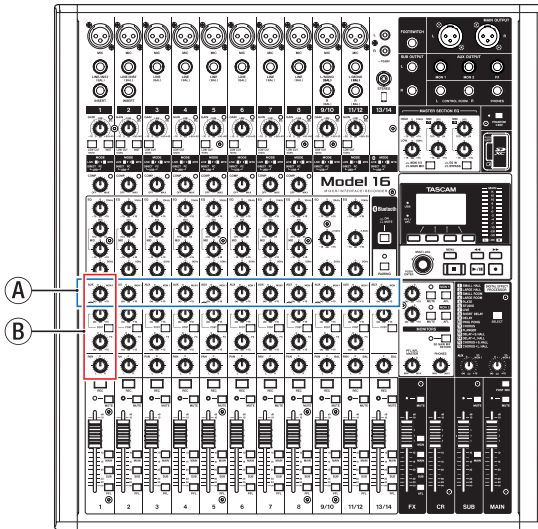

ON/OFF (INPUT) page

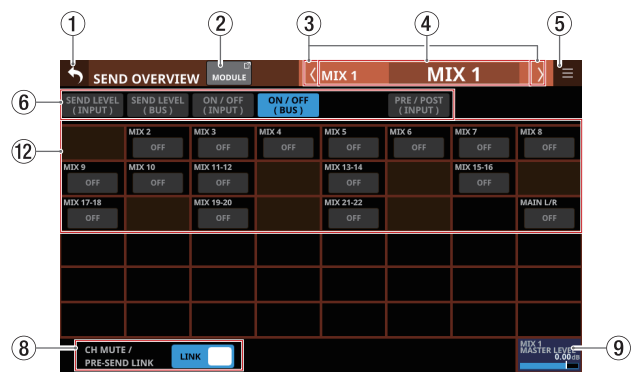

ON/OFF (BUS) page

MIX 1–22 bus SEND OVERVIEW Screen

Tap Menu Screen > Mixer Setup menu > MIX Send Overview to open this screen. The SEND OVERVIEW button at the top of the MODULE Screen for a MIX 1–22 module can also be tapped to open this screen.



SEND LEVEL (INPUT) page

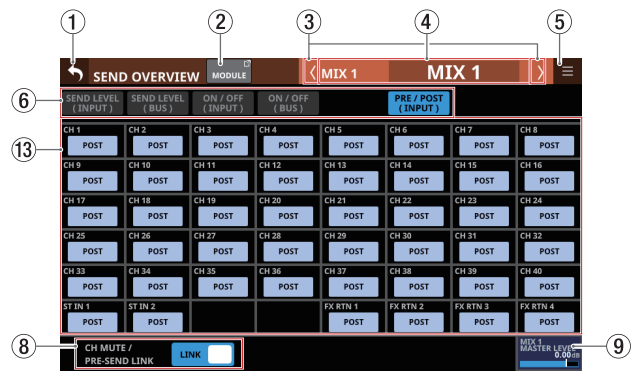

PRE/POST (INPUT) page

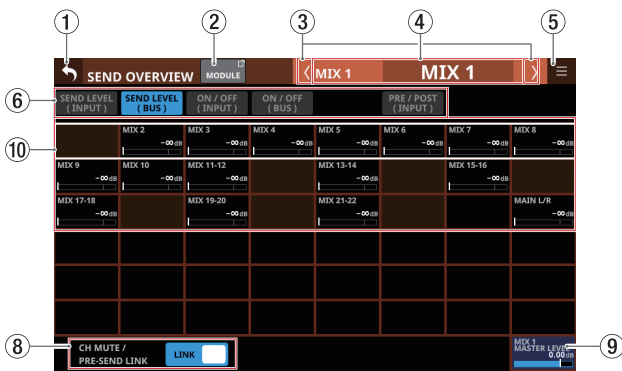

SEND LEVEL (BUS) page

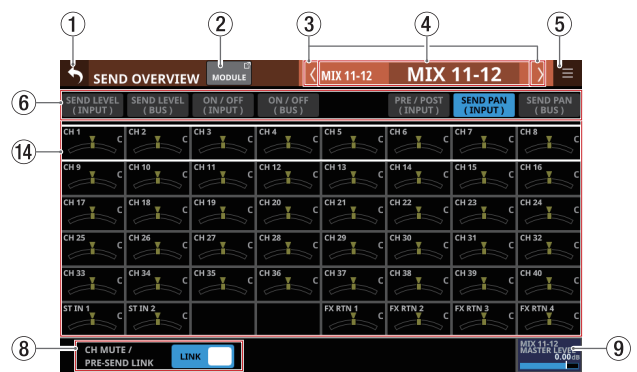

SEND PAN (INPUT) page

7 – Other module parameter setting screens

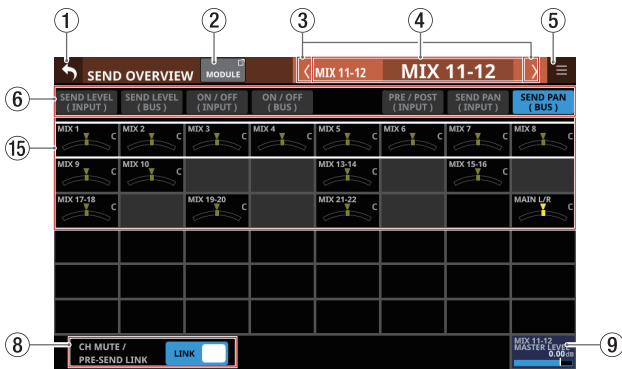

SEND PAN (BUS) page



ON/OFF (INPUT) page (GROUP mode bus)

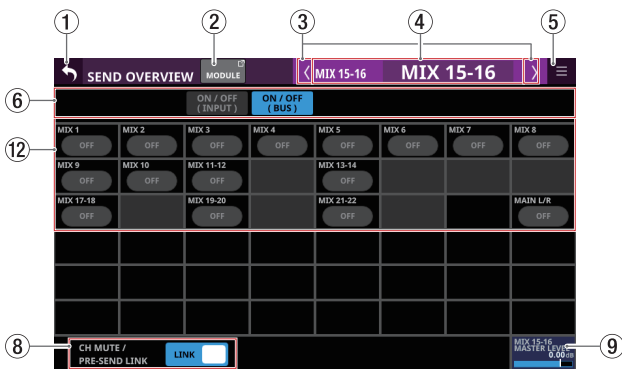

ON/OFF (BUS) page (GROUP mode bus)

NOTE

- Tap a level while pressing the HOME key on the top panel to set that level to 0 dB.
- Tap a PAN/BAL indicator while pressing the HOME key to set the tapped pan/balance setting to center (C).

1 button

Tap this button to return to the screen shown before the SEND OVERVIEW Screen.

2 **MODULE** button

Tap this button to open the MODULE Screen for the selected MIX 1–22 module.

3 buttons

Tap these buttons to move left and right in order between MIX 1–22, FX 1–4 and MAIN L/R buses to show and activate them for operation.

4 **Module name**

- This shows the module name and user module name for the selected bus. If the user module name has not been defined, the module name will be shown as “MIX 1”, for example.
- Tap the user module name area to open the MODULE NAME Screen where the user module name and set module color can be changed. (See “MODULE NAME screen” on page 166.)

5 button

Tap this button to open the SEND OVERVIEW menu for the selected MIX 1–22 bus.



Tap menu items to change parameter settings for the selected MIX 1–22 buses. (See “SEND OVERVIEW menu” on page 161.)

6 **Page selection buttons**

Tap a page selection button to open that page. The selected button will be highlighted.

| Button | Use |
|--------------------|---|
| SEND LEVEL (INPUT) | This shows a list of SEND levels from the CH 1–40, ST IN 1–2 and FX RTN 1–4 modules to the MIX 1–22 buses. |
| SEND LEVEL (BUS) | This shows a list of SEND levels from the MIX 1–22 and MAIN L/R Master modules to the MIX 1–22 buses. |
| ON / OFF (INPUT) | This shows a list of assignment on/off states from the CH 1–40, ST IN 1–2 and FX RTN 1–4 modules to the MIX 1–22 buses. |
| ON / OFF (BUS) | This shows a list of assignment on/off states from the MIX 1–22 and MAIN L/R Master modules to the MIX 1–22 buses. |
| PRE / POST (INPUT) | This shows a list of signal send positions from the CH 1–40, ST IN 1–2 and FX RTN 1–4 modules to the MIX 1–22 buses. |
| SEND PAN (INPUT) | This shows a list of pan/balance settings from the CH 1–40, ST IN 1–2 and FX RTN 1–4 modules to the MIX 1–22 buses. |
| SEND PAN (BUS) | This shows a list of pan/balance settings from the MIX 1–22 modules to the MIX 1–22 buses. |

7 – Other module parameter setting screens

⑦ SEND levels

- This shows a list of setting states for SEND levels from the CH 1–40, ST IN 1–2 and FX RTN 1–4 modules to the MIX 1–22 buses.
- When a selection frame is shown, use corresponding LCD knobs (lit orange) to adjust SEND levels.

Range: $-\infty$ dB – +10 dB (default: $-\infty$ dB)

⑧ CH MUTE / PRE-SEND LINK

Set separately for each bus whether or not input module MUTE and Pre Fader Send MUTE from the input module to the AUX bus are linked.

Tap THIS button to switch the setting between LINK and UNLINK.

| Display | Explanation |
|----------------|---|
| LINK (default) | Input module MUTE and Pre Fader Send MUTE from the input module to the AUX bus are linked |
| UNLINK | Input module MUTE and Pre Fader Send MUTE from the input module to the AUX bus are not linked |

⑨ MIX MASTER LEVEL

This adjusts the FADER level (bus master level) for the selected MIX 1–22 bus.

Range: $-\infty$ dB – +10 dB (default: 0.0 dB)

When the selection frame is shown, turn LCD knob 8 (lit blue) to adjust it.

⑩ SEND levels

- This shows a list of setting states for SEND levels from the MIX 1–22 and MAIN L/R Master modules to the MIX 1–22 buses.
- When a selection frame is shown, use corresponding LCD knobs (lit orange) to adjust SEND levels.

Range: $-\infty$ dB – +10 dB (default: $-\infty$ dB)

NOTE

A SEND level for the same bus as the selected bus shown in the module name area (④) is not shown.

⑪ Input module ON/OFF buttons

- This shows a list of assignment ON/OFF states from the CH 1–40, ST IN 1–2 and FX RTN 1–4 modules to the MIX 1–22 buses.
- Tap these buttons to switch on/off assignments to MIX 1–22 buses. (Default: ON)
When ON, buttons will be highlighted.

⑫ BUS module ON/OFF buttons

- This shows a list of assignment ON/OFF states from the MIX 1–22 and MAIN L/R Master modules to the MIX 1–22 buses.
- Tap these buttons to switch on/off assignments to MIX 1–22 buses. (Default: OFF)
When ON, buttons will be highlighted.

NOTE

An assignment button for the same bus as the selected bus shown in the module name area (④) is not shown.

⑬ PRE/POST buttons

- This shows a list of settings for send positions from the CH 1–40, ST IN 1–2 and FX RTN 1–4 modules to the MIX 1–22 buses.
- Tap these buttons to switch settings for send positions to MIX 1–22 buses. (See “16 – Block diagram” on page 251.)

| Display | Explanation |
|----------------|-------------|
| PRE | Pre-fader |
| POST (default) | Post-fader |

Tap the buttons to switch their send positions.

⑭ PAN/BAL for CH 1–40, ST IN 1–2 and FX RTN 1–4 modules

- This shows a list of setting states for pan/balance from the CH 1–40, ST IN 1–2 and FX RTN 1–4 modules to the selected MIX 1–22 buses.
- When a selection frame is shown, use corresponding LCD knobs (lit yellow) to adjust the pan/balance.

Range: L100 – C – R100 (default: C)

NOTE

For buses that have the PAN LINK setting on, the SEND PAN parameters appear dim and cannot be operated. They are linked to the PAN/BAL settings of the corresponding modules.

⑮ MIX 1–22 module PAN/BAL

- This shows a list of setting states for pan/balance from the MIX 1–22 modules to the selected MIX 1–22 bus.
- When a selection frame is shown, use corresponding LCD knobs (lit yellow) to adjust the pan/balance.

Range: L100 – C – R100 (default: C)

NOTE

For buses that have the PAN LINK setting on, the SEND PAN parameters appear dim and cannot be operated. They are linked to the PAN/BAL settings of the corresponding modules.

7 – Other module parameter setting screens

FX 1–4 bus SEND OVERVIEW Screen

Tap Menu Screen > Mixer Setup menu> MIX Send Overview to open this screen. The SEND OVERVIEW button at the top of the MODULE Screen for a FX RTN 1–4 module can also be tapped to open this screen.

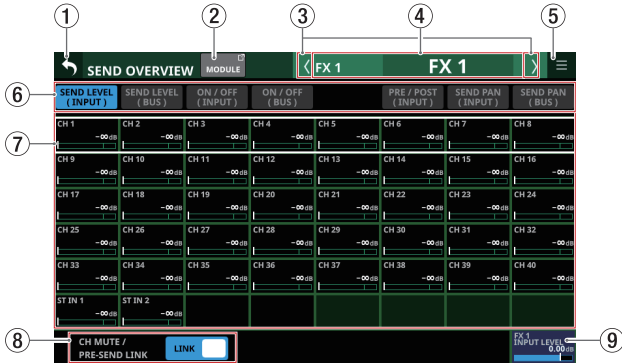

SEND LEVEL (INPUT) page

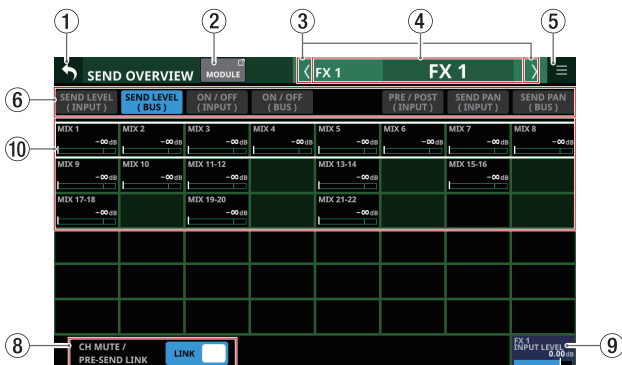

SEND LEVEL (BUS) page

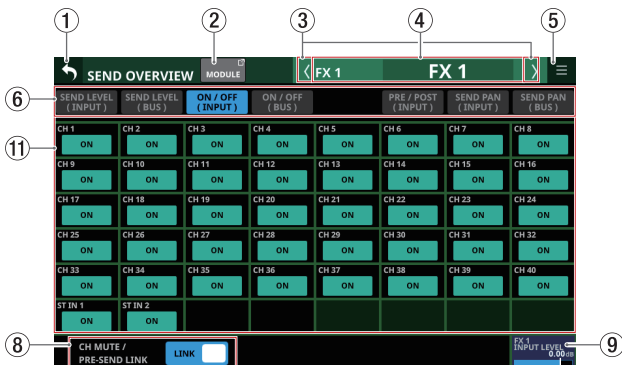

ON/OFF (INPUT) page

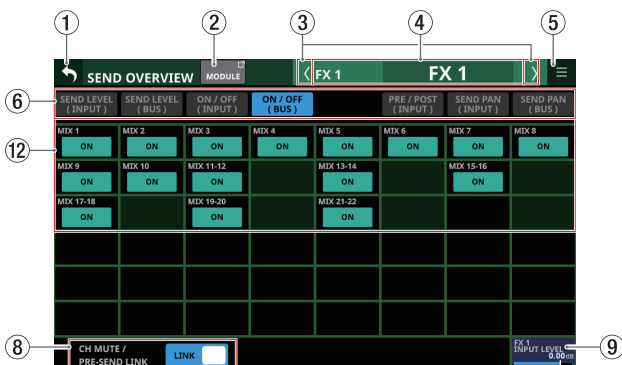

ON/OFF (BUS) page

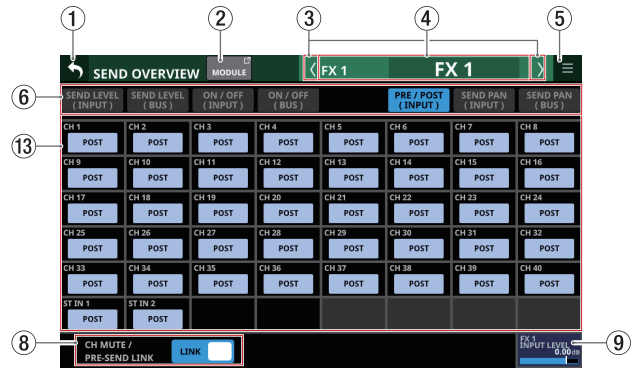

PRE/POST (INPUT) page

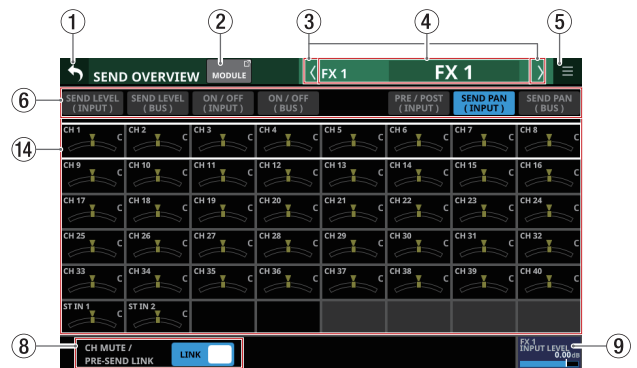

SEND PAN (INPUT) page

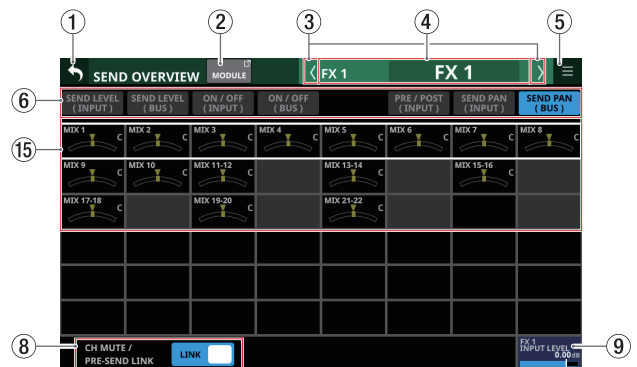

SEND PAN (BUS) page

NOTE

Tap a level while pressing the HOME key on the top panel to set that level to 0 dB.

- ① **↶ button**
Tap this button to return to the screen shown before the SEND OVERVIEW Screen.
- ② **MODULE button**
Tap this button to open the MODULE Screen for the FX RTN 1–4 module that corresponds to the FX 1–4 bus shown.
- ③ **↷ buttons**
Tap these buttons to move left and right in order between MIX 1–22, FX 1–4 and MAIN L/R buses to show and activate them for operation.

7 – Other module parameter setting screens

④ Module name

- This shows the module name and user module name for the selected bus. If the user module name has not been defined, the module name will be shown as “FX 1”, for example.
- Tap the user module name area to open the MODULE NAME Screen where the user module name and set module color can be changed. (See “MODULE NAME screen” on page 166.)

⑤ button

Tap this button to open the SEND OVERVIEW menu for the selected FX 1–4 bus.

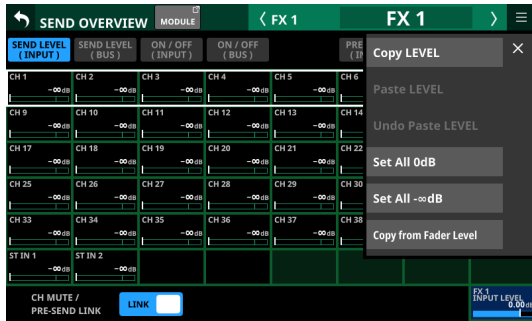

Tap menu items to change parameter settings for the selected FX 1–4 buses. (See “SEND OVERVIEW menu” on page 161.)

⑥ Page selection buttons

Tap a page selection button to open that page. The selected button will be highlighted.

| Button | Use |
|--------------------|---|
| SEND LEVEL (INPUT) | This shows a list of SEND levels from the CH 1–40 and ST IN 1–2 modules to the FX 1–4 buses. |
| SEND LEVEL (BUS) | This shows a list of SEND levels from the MIX 1–22 modules to the FX 1–4 buses. |
| ON / OFF (INPUT) | This shows a list of assignment on/off states from the CH 1–40 and ST IN 1–2 modules to the FX 1–4 buses. |
| ON / OFF (BUS) | This shows a list of assignment on/off states from the MIX 1–22 modules to the FX 1–4 buses. |
| PRE / POST (INPUT) | This shows a list of signal send positions from the CH 1–40 and ST IN 1–2 modules to the FX 1–4 buses. |
| SEND PAN (INPUT) | This shows a list of pan/balance settings from the CH 1–40 and ST IN 1–2 modules to the FX 1–4 buses. |
| SEND PAN (BUS) | This shows a list of pan/balance settings from the MIX 1–22 modules to the FX 1–4 buses. |

⑦ SEND levels

- This shows a list of setting states for SEND levels from the CH 1–40 and ST IN 1–2 modules to the FX 1–4 buses.
- When a selection frame is shown, use corresponding LCD knobs (lit green) to adjust SEND levels.
Range: $-\infty$ dB – +10 dB (default: $-\infty$ dB)

⑧ CH MUTE / PRE-SEND LINK

Set separately for each bus whether or not input module MUTE and Pre Fader Send MUTE from the input module to the AUX bus are linked. Tap this button to switch the setting between LINK and UNLINK.

| Display | Explanation |
|----------------|---|
| LINK (default) | Input module MUTE and Pre Fader Send MUTE from the input module to the AUX bus are linked |
| UNLINK | Input module MUTE and Pre Fader Send MUTE from the input module to the AUX bus are not linked |

⑨ FX INPUT LEVEL

This adjust the input level for the FX 1–4 module that corresponds to the FX 1–4 bus shown.

Range: $-\infty$ dB – +10 dB (default: 0.0 dB)

When the selection frame is shown, turn LCD knob 8 (lit blue) to adjust it.

NOTE

This is the same parameter as the FX RTN 1–4 module INPUT LEVEL knob (⑦) (“MODULE (FX) Screen” on page 132).

⑩ SEND levels

- This shows a list of setting states for SEND levels from the MIX 1–22 modules to the FX 1–4 buses.
- When a selection frame is shown, use corresponding LCD knobs (lit green) to adjust SEND levels.
Range: $-\infty$ dB – +10 dB (default: $-\infty$ dB)

⑪ Input module ON/OFF buttons

- This shows a list of assignment on/off states from the CH 1–40 and ST IN 1–2 modules to the FX 1–4 buses.
- Tap these buttons to switch on/off assignments to FX 1–4 buses. (Default: ON)
When ON, buttons will be highlighted.

⑫ BUS module ON/OFF buttons

- This shows a list of assignment on/off states from the MIX 1–22 modules to the FX 1–4 buses.
- Tap these buttons to switch on/off assignments to FX 1–4 buses. (Default: ON)
When ON, buttons will be highlighted.

7 – Other module parameter setting screens

13 PRE/POST buttons

- This shows a list of signal send position settings from the CH 1–40 and ST IN 1–2 modules to the FX 1–4 buses.
- Tap these buttons to switch settings for send positions to FX 1–4 buses. (See “16 – Block diagram” on page 251.)

| Display | Explanation |
|----------------|-------------|
| PRE | Pre-fader |
| POST (default) | Post-fader |

Tap the buttons to switch their send positions.

14 PAN/BAL for CH 1–40 and ST IN 1–2 modules

This shows a list of setting states for pan/balance from the CH 1–40 and ST IN 1–2 modules to the selected FX 1–4 buses.

Display range: L100 – C – R100 (default: C)

NOTE

FX 1–4 bus SEND PAN parameters are always linked to the PAN/BAL settings of the corresponding modules (PAN LINK setting is always on). They are shown dimly and cannot be operated on this screen.

15 MIX 1–22 module PAN/BAL

This shows a list of setting states for pan/balance from the MIX 1–22 modules to the selected FX 1–4 bus.

Display range: L100 – C – R100 (default: C)

NOTE

FX 1–4 bus SEND PAN parameters are always linked to the PAN/BAL settings of the corresponding modules (PAN LINK setting is always on). They are shown dimly and cannot be operated on this screen.

MAIN L/R bus SEND OVERVIEW Screen

Tap Menu Screen > Mixer Setup menu > MIX Send Overview or Main L/R Assign Overview to open this screen. The SEND OVERVIEW button at the top of the MODULE Screen for the MAIN L/R Master module can also be tapped to open this screen.

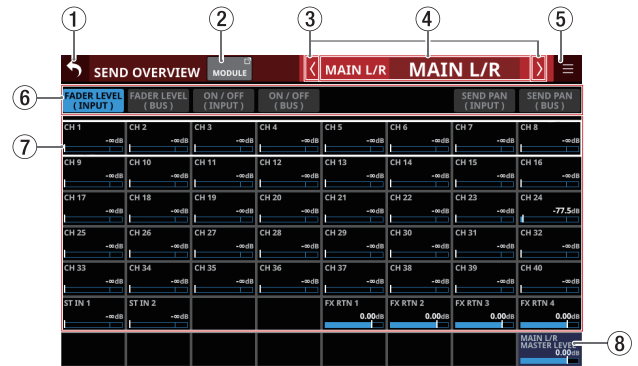

FADER LEVEL (INPUT) page

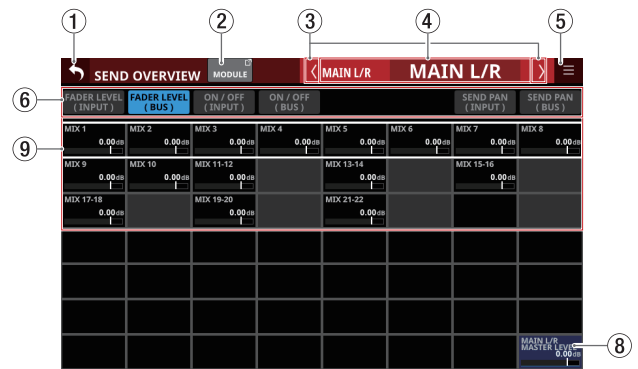

FADER LEVEL (BUS) page



ON/OFF (INPUT) page

7 – Other module parameter setting screens

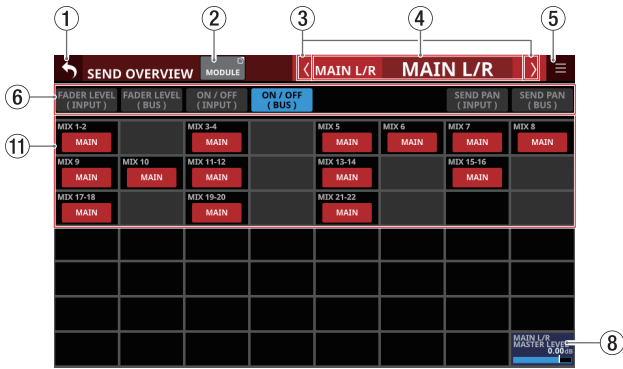

ON/OFF (BUS) page

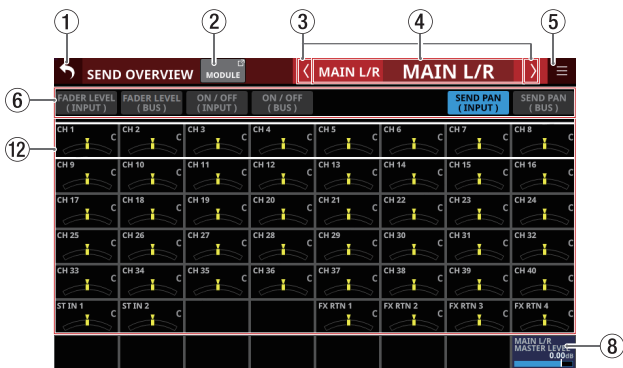

SEND/PAN (INPUT) page

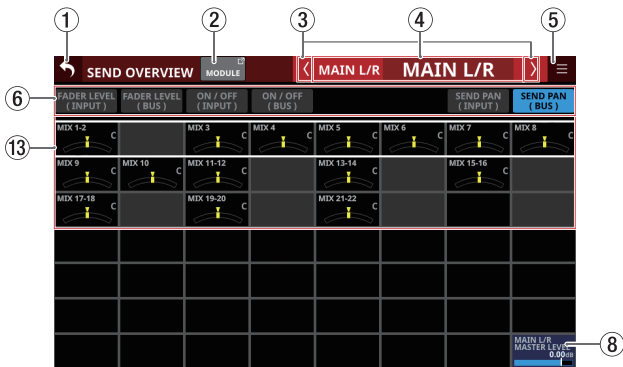

SEND/PAN (BUS) page

NOTE

- Tap a level while pressing the HOME key on the top panel to set that level to 0 dB.
- Tap a PAN/BAL indicator while pressing the HOME key to set the tapped pan/balance setting to center (C).

1 button

Tap this button to return to the screen shown before the SEND OVERVIEW Screen.

2 **MODULE** button

Tap this button to open the MODULE Screen for the selected MAIN L/R Master module.

3 buttons

Tap these buttons to move left and right in order between MIX 1–22, FX 1–4 and MAIN L/R buses to show and activate them for operation.

4 **Module name**

- This shows the module name and user module name for the selected bus. If the user module name has not been defined, the module name will be shown as “MAIN L/R”, for example.
- Tap the user module name area to open the MODULE NAME Screen where the user module name and set module color can be changed. (See “MODULE NAME screen” on page 166.)

5 button

Tap this button to open the SEND OVERVIEW menu for the MAIN L/R bus.

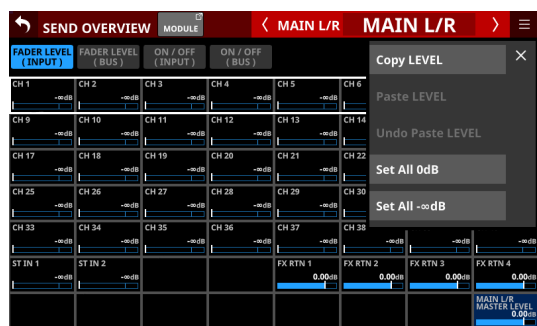

Tap menu items to change parameter settings for the MAIN L/R bus. (See “SEND OVERVIEW menu” on page 161.)

6 **Page selection buttons**

Tap a page selection button to open that page. The selected button will be highlighted.

| Button | Use |
|---------------------|---|
| FADER LEVEL (INPUT) | This shows a list of FADER levels for the CH 1–40, ST IN 1–2 and FX RTN 1–4 modules. |
| FADER LEVEL (BUS) | This shows a list of FADER levels for the MIX 1–22 modules. |
| ON / OFF (INPUT) | This shows a list of assignment on/off states from the CH 1–40, ST IN 1–2 and FX RTN 1–4 modules to the MAIN L/R bus. |
| ON / OFF (BUS) | This shows a list of assignment on/off states from the MIX 1–22 modules to the MAIN L/R bus. |
| SEND PAN (INPUT) | This shows a list of pan/balance settings from the CH 1–40, ST IN 1–2 and FX RTN 1–4 modules to the MAIN L/R bus. |
| SEND PAN (BUS) | This shows a list of pan/balance settings from the MIX 1–22 modules to the MAIN L/R bus. |

7 – Other module parameter setting screens

⑦ FADER levels

- This shows a list of FADER level setting states for the CH 1–40, ST IN 1–2 and FX RTN 1–4 modules.
- When a selection frame is shown, use corresponding LCD knobs (lit blue) to adjust FADER levels.

| Module name | Range | default |
|-------------|----------------|---------|
| CH 1–40 | -∞ dB – +10 dB | -∞ dB |
| ST IN 1–2 | | 0.0 dB |
| FX RTN 1–4 | | 0.0 dB |

⑧ MAIN L/R MASTER LEVEL

This adjusts the FADER level of the MAIN L/R Master module.

Range: -∞ dB – +10 dB (default: 0.0 dB)

When the selection frame is shown, turn LCD knob 8 (lit blue) to adjust it.

⑨ FADER levels

- This shows a list of FADER level setting states for the MIX 1–22 modules.
- When a selection frame is shown, use corresponding LCD knobs (lit blue) to adjust FADER levels.

Range: -∞ dB – +10 dB (default: 0.0 dB)

⑩ MAIN L/R assignment state indicators/buttons for input modules

- This shows a list of assignment on/off states from the CH 1–40, ST IN 1–2 and FX RTN 1–4 modules to the MAIN L/R bus.
- Tap these buttons to turn on/off assignments to the MAIN L/R bus.

Options: on (default), off

When this is on, the button will appear highlighted.

⑪ MAIN L/R assignment state indicators/buttons for BUS modules

- This shows a list of assignment on/off states from the MIX 1–22 modules to the MAIN L/R bus.
- Tap these buttons to turn on/off assignments to the MAIN L/R bus.

Options: on, off (default)

When this is on, the button will appear highlighted.

⑫ PAN/BAL for CH 1–40, ST IN 1–2 and FX RTN 1–4 modules

- This shows a list of setting states for pan/balance from the CH 1–40, ST IN 1–2 and FX RTN 1–4 modules to the MAIN L/R bus.
- When a selection frame is shown, use corresponding LCD knobs (lit yellow) to adjust the pan/balance.

Range: L100 – C – R100 (default: C)

⑬ MIX 1–22 module PAN/BAL

- This shows a list of setting states for pan/balance from the MIX 1–22 modules to the MAIN L/R bus.
- When a selection frame is shown, use corresponding LCD knobs (lit yellow) to adjust the pan/balance.

Range: L100 – C – R100 (default: C)

7 – Other module parameter setting screens

SEND OVERVIEW menu

SEND OVERVIEW menu operations

- Tap the button at the top right of the SEND OVERVIEW screen to open the SEND OVERVIEW menu for the selected bus.
- Tap menu items to change parameter settings for the selected bus all at once.
- Tap the SEND OVERVIEW menu button or the button to close the menu.

SEND OVERVIEW menu items

SEND LEVEL (INPUT), SEND LEVEL (BUS) and FADER LEVEL (INPUT)

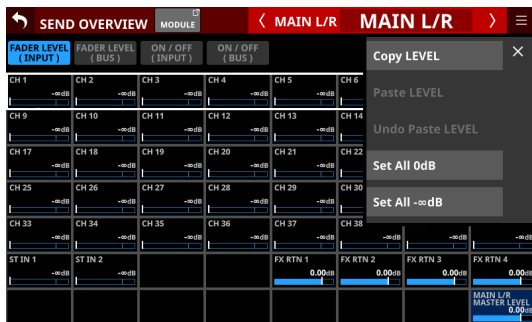
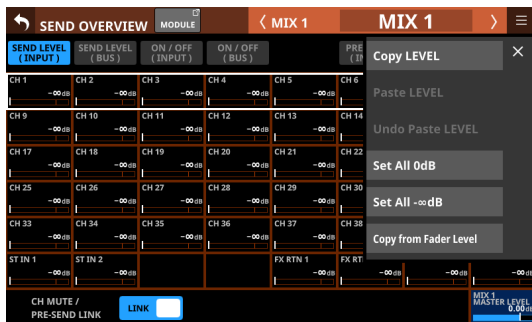

| Menu item | Function |
|-----------------------|--|
| Copy LEVEL | This copies the SEND level to the selected bus to a buffer. |
| Paste LEVEL | This pastes the SEND level copied to the buffer to the selected bus. |
| Undo Paste LEVEL | This undoes pasting the SEND level. |
| Redo Paste LEVEL | This redoes pasting the SEND level. |
| Set All 0dB | This sets all the SEND levels to the selected bus to 0 dB. |
| Set All -∞dB | This sets all the SEND levels to the selected bus to -∞ dB. |
| Copy from Fader Level | This copies the FADER level to the SEND level to the selected bus. |

NOTE

- When the selected bus is MAIN L/R, this will change the FADER level setting.
- When the selected bus is MAIN L/R, the “Copy from Fader Level” menu item will not be shown.

ON/OFF (INPUT) and ON/OFF (BUS)

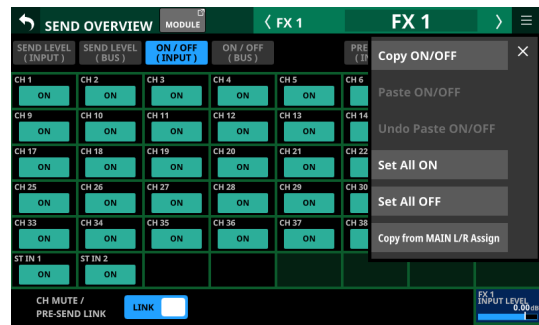

| Menu item | Function |
|---------------------------|---|
| Copy ON/OFF | This copies the assignment settings of the selected bus to a buffer. |
| Paste ON/OFF | This pastes the assignment settings to the selected bus that were copied to the buffer to the selected bus. |
| Undo Paste ON/OFF | This undoes the pasting of assignment settings to the selected bus. |
| Redo Paste ON/OFF | This redoes pasting of assignment settings to the selected bus. |
| Set All ON | This turns on all assignment settings to the selected bus. |
| Set All OFF | This turns off all assignment settings to the selected bus. |
| Copy from MAIN L/R Assign | This copies the MAIN L/R bus assignment settings to the selected bus assignment settings. |

NOTE

- When the selected bus is MAIN L/R, this will change the states of assignments to the MAIN L/R bus.
- When the selected bus is MAIN L/R, the “Copy from MAIN L/R Assign” menu item will not be shown.

7 – Other module parameter setting screens

PRE / POST (INPUT)

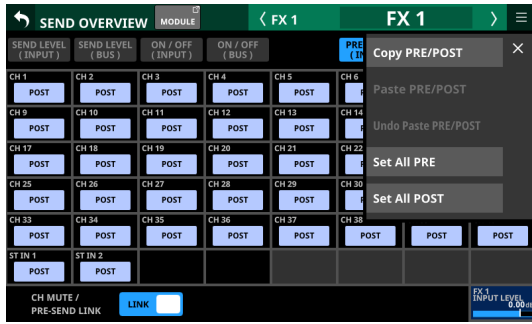

| Menu item | Function |
|---------------------|---|
| Copy PRE/POST | This copies the PRE/POST settings to the selected bus to a buffer. |
| Paste PRE/POST | This pastes the PRE/POST settings to the selected bus that were copied to the buffer to the selected bus. |
| Undo Paste PRE/POST | This undoes the pasting of PRE/POST settings to the selected bus. |
| Redo Paste PRE/POST | This redoes pasting of PRE/POST settings to the selected bus. |
| Set All PRE | This sets all PRE/POST settings to the selected bus to PRE. |
| Set All POST | This sets all PRE/POST settings to the selected bus to POST. |

SEND PAN (INPUT) and SEND PAN (BUS)

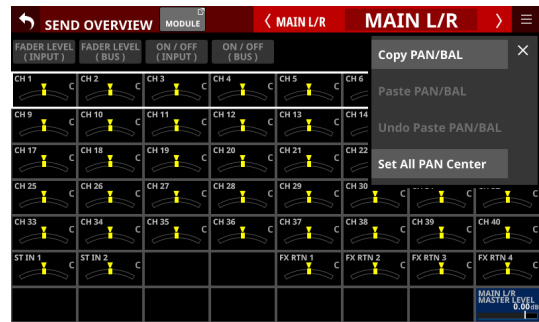

| Menu item | Function |
|------------------------|--|
| Copy PAN/BAL | This copies the pan/balance settings to the selected bus to a buffer. |
| Paste PAN/BAL | This pastes the pan/balance settings to the selected bus that were copied to the buffer to the selected bus. |
| Undo Paste PAN/BAL | This undoes the pasting of pan/balance settings to the selected bus. |
| Redo Paste PAN/BAL | This redoes pasting of pan/balance settings to the selected bus. |
| Set All PAN Center | This sets all pan/balance settings to the selected bus to center (C). |
| Copy from MAIN L/R PAN | This copies the MAIN L/R bus pan/balance settings to the selected bus pan/balance settings. |

NOTE

When the selected bus is MAIN L/R, the "Copy from MAIN L/R PAN" menu item will not be shown.

7 – Other module parameter setting screens

Mute Group and DCA functions

Mute Group function

- This unit has 8 mute groups.
- Mute groups allow the muting state of a group of modules assigned to it to be turned on/off together. However, if MUTE for a module was set to ON before MUTE was set to ON for the mute group, MUTE will stay ON for that module when the group MUTE is set to OFF.
- The MUTE indicators will blink for modules muted as part of a mute group.
- The following can be used to operate mute groups.
 - MUTE GROUP MASTER page
 - USER KEY/FOOTSWITCH/GPIO-IN controls assigned to the Mute Group function (See "USER DEFINED CONTROLS screen" on page 44.)

NOTE

The Mute Group function is assigned to the following by default on the User Key and GPIO-IN pages.

- USER KEY 1–4 (Mute Group 1–4)
- GPIO-IN 1–5 (Mute Group 1–5)

DCA (Digital Control Amplifier) functions

- This unit has 8 DCAs.
 - A DCA enables simultaneously adjusting the levels of a group of assigned modules while maintaining the balance of their fader levels. For example, if two modules assigned to a DCA have fader levels of -10 dB and -15 dB, when the DCA module FADER level is raised 5 dB, their fader levels will increase from -10 dB to -5 dB and -15 dB to -10 dB. In this case, the physical fader positions of the assigned faders will not change.
 - DCA module MUTE keys function the same way as Mute Groups. The MUTE indicators will blink for modules muted in DCA modules.
 - Like mute groups, DCA module SOLO keys, allow the solo state of a group of modules assigned to it to be turned on/off together. However, if SOLO for a module was set to ON before SOLO was set to ON for the DCA module, SOLO will stay ON for that module when the DCA module SOLO is set to OFF.
 - The SOLO indicators will blink for modules that have SOLO turned on in DCA modules.
 - DCAs are operated by faders and MUTE and SOLO keys assigned to DCA layers and DCA modules.
 - One DCA can also be assigned to another DCA (DCA assignment nesting). The following DCA assignments, however, are not possible.
 - Self-assignment (for example, DCA 1 cannot be assigned to DCA 1)
 - Assignment of a DCA that is at a higher level (For example, if DCA 1 is above DCA 2, which is above DCA 3, in the structure, DCA 1 cannot be assigned to DCA 2, and DCA 1 and DCA 2 cannot be assigned to DCA 3.)
- DCA modules that cannot be assigned have frames around their module button areas (④).

DCA/Mute Group SETUP screen

DCA and Mute Group settings can be made on this screen. Use the following procedures to open this screen.

- Tap Menu screen > Mixer Setup menu > DCA/Mute Group
- Tap a DCA or MUTE GROUP button on the MODULE (OVERVIEW) screen
- Tap a DCA assignment area on the DCA Module Home Screen
- Press a USER key assigned to a MUTE Group while pressing the MENU key on the top panel

DCA Assign page

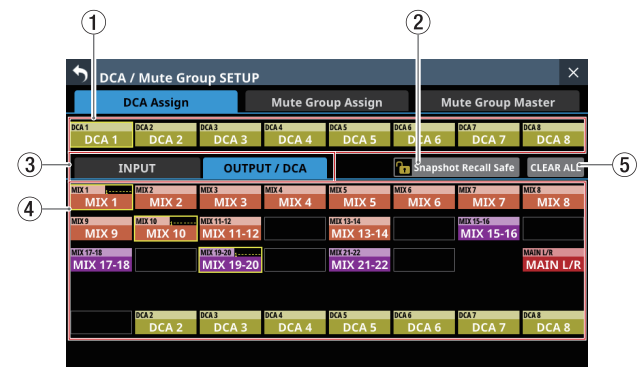
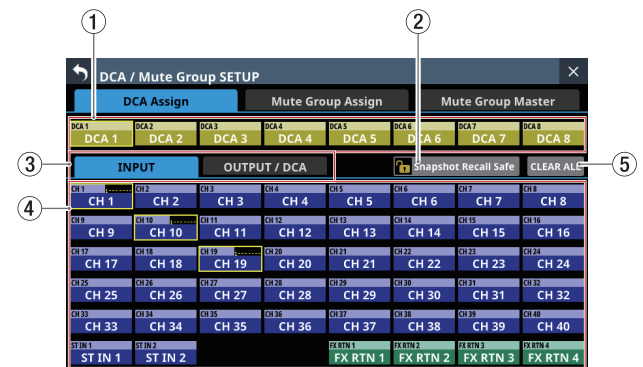

① DCA buttons

Tap these buttons to select DCAs for changing assignments. Selected DCA buttons will be highlighted.

② Snapshot Recall Safe button

Tap this button to enable the Snapshot Recall Safe function for the selected DCA. (Default: off)

When this is on, the button will appear highlighted.

NOTE

This can also be set on the MODULE SAFE page of the SNAPSHOT RECALL SAFE Screen. (See "MODULE SAFE page" on page 178.)

③ Module type selection pages

These are page buttons for module types assigned to the DCA.

Buttons selected by tapping will be highlighted.

7 – Other module parameter setting screens

④ Module buttons

These are buttons for selecting modules assigned to the selected DCA.
Tapping these buttons, highlighting them, will assign them to the DCA.

NOTE

At the top right, the Mute Group assignment status is shown in the top line and the DCA assignment status is shown in the bottom line in the same way as in the NAME area on the Home Screen. (See “⑫ NAME area” on page 20.)

⑤ CLEAR ALL button

Tap this button to open a message confirming whether to clear all INPUT and OUTPUT/DCA assignments to the selected DCA.

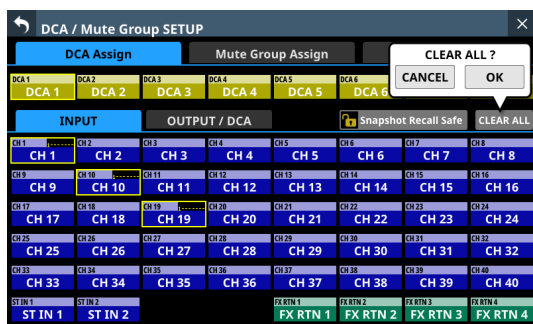

Tap OK to clear all assignments.

Mute Group Assign page

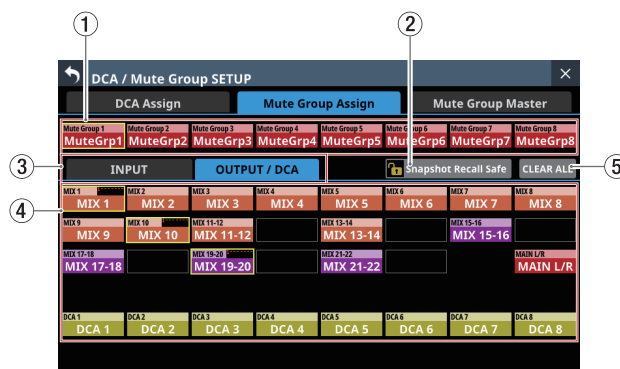
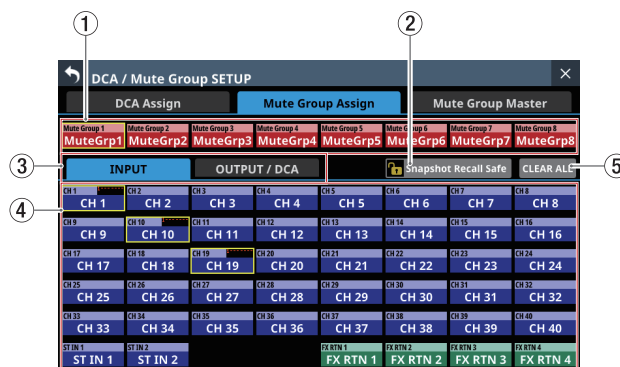

① MuteGrp buttons

Tap these buttons to select a Mute Group for changing assignments.
The selected Mute Group button will be highlighted.

② Snapshot Recall Safe button

Tap this button to enable the Snapshot Recall Safe function for the selected Mute Group. (Default: off)
When this is on, the button will appear highlighted.

③ Module type selection pages

These are page buttons for module types assigned to the Mute Group.
Buttons selected by tapping will be highlighted.

7 – Other module parameter setting screens

④ Module buttons

These are buttons for selecting modules assigned to the selected Mute Group.
Tapping these buttons, highlighting them, will assign them to the Mute Group.

NOTE

At the top right, the Mute Group assignment status is shown in the top line and the DCA assignment status is shown in the bottom line in the same way as in the NAME area on the Home Screen. (See “⑫ NAME area” on page 20.)

⑤ CLEAR ALL button

Tap this button to open a message confirming whether to clear all INPUT and OUTPUT/DCA assignments to the selected DCA.

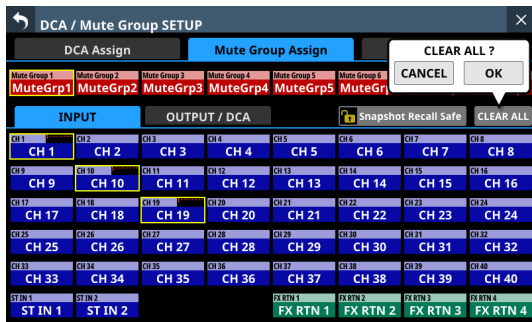

Tap OK to clear all assignments.

Mute Group Master page

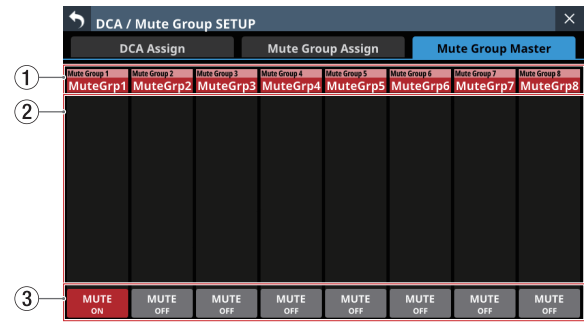

① Mute Group names

- These show Mute Group names and user-defined Mute Group names.
- Tap these areas to open the MODULE NAME Screen where the user module name and set module color can be changed for the selected Mute Group. (See “MODULE NAME screen” on page 166.)

② Mute Group assignment list

This list shows the names of modules that have been assigned to mute groups.

③ MUTE buttons

These are Mute Group Master MUTE buttons. (Default: OFF)
Tap these buttons to turn them on and off.
When on, these buttons will appear highlighted and the modules assigned to those Mute Groups will be muted.
In this case, the MUTE keys will blink for modules muted as part of a mute group.

NOTE

Using the User Defined Control function, the Mute Group function can also be operated with USER KEYS, FOOTSWITCH and GPIO-IN controls. (See “USER DEFINED CONTROLS screen” on page 44.)

The Mute Group MUTE function is assigned to the following by default on the User Key and GPIO-IN pages.

- USER KEY 1–4 (Mute Group 1–4)
- GPIO-IN 1–5 (Mute Group 1–5)

7 – Other module parameter setting screens

MODULE NAME screen

The following settings can be made on this screen.

- The user module names that are shown on screens can be set and edited.
- The set module name background colors shown on screens as well as the lit colors of channel color bars can be changed.
- Module icons shown on channel screens can be set.
- Mute Group user module names can be set and edited. Set Mute Group module colors can be changed.

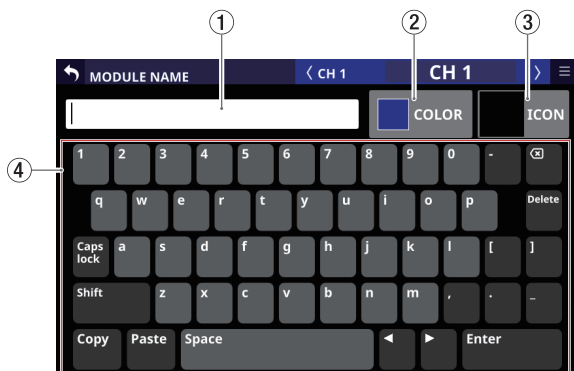

CH 1 MODULE NAME Screen

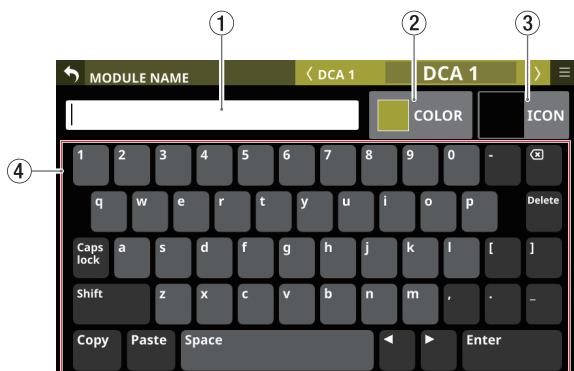

DCA 1 MODULE NAME Screen

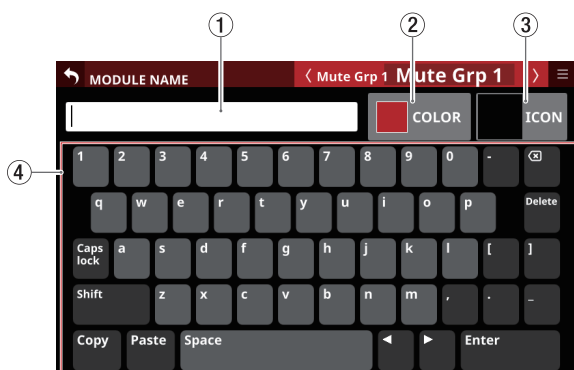

Mute Group MODULE NAME Screen

① Keyboard input area

- This shows the user module name being edited. Use the keyboard and buttons on this screen or a USB keyboard connected to the top panel USB port to edit the characters shown.
- Tap this area when the color palette or icon selection area is open to show the keyboard in the keyboard area (④).

② COLOR button

Tap this button to open the color palette where the set module color can be changed. (See “Changing set module colors” on page 168.)

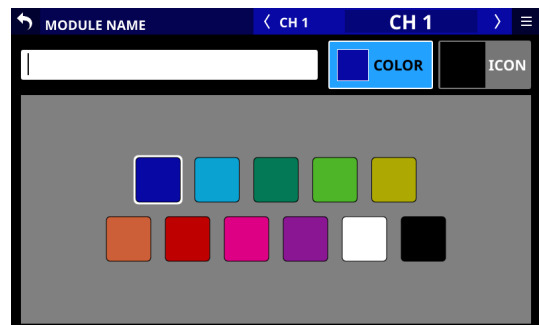

③ ICON button

Tap this button to open the icon selection area where icons for each module shown on channel screens can be set. (See “Setting module icons” on page 169.)

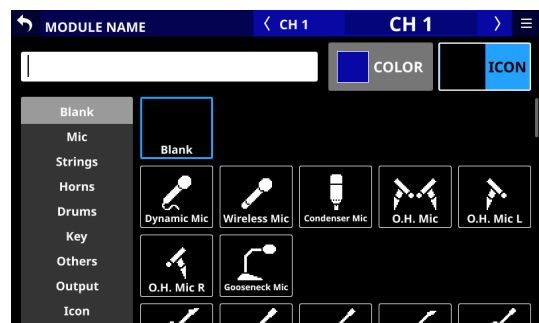

④ Keyboard area

- Tap the keyboard buttons in this area to edit the user module name shown in the keyboard input area.
- Tap the Copy button to copy the characters shown in the keyboard input area to the copy buffer.
- Tap the Paste button to paste the characters in the copy buffer to the keyboard input area.

7 – Other module parameter setting screens

Setting and editing user module names

User module names can be set and edited.

NOTE

User module names are not set by default.

1. To open the MODULE NAME Screen, tap a user module name display area on a MODULE, SEND OVERVIEW, MIXER CONFIG or LIBRARY screen. (For a DCA module, tap the NAME area on the Home Screen. For a MUTE GROUP, tap the Mute Group name area on the Mute Group Master page.)
2. Tap the keyboard buttons on the MODULE NAME Screen to input the user module name.

NOTE

The combination of characters input can be changed depending on the status of the Caps lock and Shift keyboard buttons on the MODULE NAME Screen. See “Changing the keyboard keys” on page 167 for details about changing the keyboard.



3. The input name will be immediately used to show the user module name on various screens as well as the module name on channel screens.

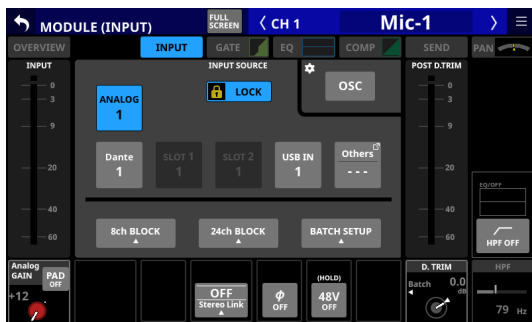
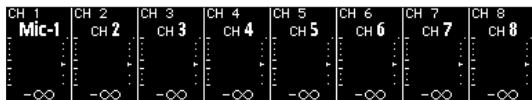

4. Tap the Enter button on the MODULE NAME Screen to open the MODULE NAME Screen for the next module to the right.

ATTENTION

The following symbols and punctuation marks cannot be input.

¥ / : * ? " < > |

NOTE

- A USB keyboard connected to the top panel USB port can also be used to input and edit characters.
- If a user module name cannot be shown completely in a display area, the end will be cut off. If the end is a number, up to two digits will be included in the abbreviated name.

Changing the keyboard keys

The Caps lock and Shift button settings change the selection of characters that can be input as shown below.

NOTE

The Shift button automatically deactivates after inputting one character.

- Setting for inputting numbers and lowercase letters

| | |
|------------------|-----|
| Caps lock button | Off |
| Shift button | Off |



- Setting for inputting numbers and uppercase letters

| | |
|------------------|------------------|
| Caps lock button | On (highlighted) |
| Shift button | Off |



7 – Other module parameter setting screens

- Setting for inputting symbols and lowercase letters

| | |
|------------------|------------------|
| Caps lock button | On (highlighted) |
| Shift button | On (highlighted) |

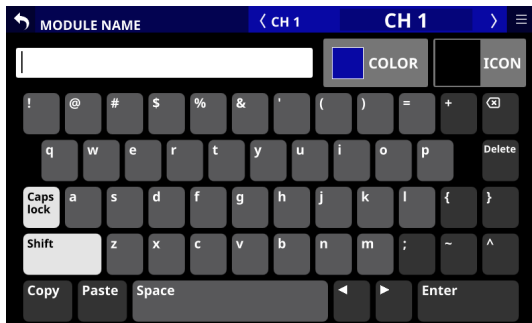

- Setting for inputting symbols and uppercase letters

| | |
|------------------|------------------|
| Caps lock button | Off |
| Shift button | On (highlighted) |

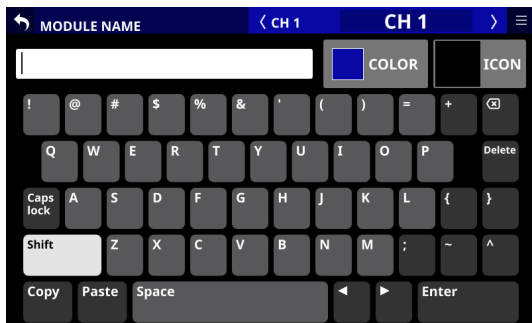

Changing set module colors

Set module name background colors shown on screens as well as the lit colors of channel color bars can be changed.

The factory default module color settings are as follows.

| | |
|--------------------------------|--------|
| CH 1–40 | Blue |
| ST IN 1–2 | Blue |
| FX RTN 1–4 | Green |
| MIX when the BUS mode is AUX | Orange |
| MIX when the BUS mode is GROUP | Purple |
| MAIN L/R | Red |
| DCA | Yellow |
| Mute Group | Red |

- To open the MODULE NAME Screen, tap a user module name display area on a MODULE, SEND OVERVIEW, MIXER CONFIG or LIBRARY screen. (For a DCA module, tap the NAME area on the Home Screen. For a MUTE GROUP, tap the Mute Group name area on the Mute Group Master page of the DCA/Mute Group SETUP Screen.)

- Tap the COLOR button on the MODULE NAME Screen to open the color palette.

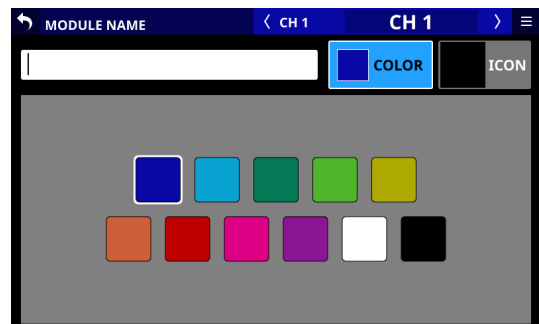

- Tap a color in the color palette to change the module color setting. This will change the module name background color shown on screens as well as the lit color of channel color bars.



NOTE

Tapping the keyboard input area on a NAME screen will reopen the keyboard.

7 – Other module parameter setting screens

Setting module icons

Icons shown for modules on channel screens can be set.

NOTE

Module icons are not set by default.

1. To open the MODULE NAME Screen, tap a module name display area on a MODULE, SEND OVERVIEW, MIXER CONFIG or LIBRARY screen. (For a DCA module, tap the NAME area on the Home Screen.)
2. Tap the ICON button on the MODULE NAME Screen to open the icon selection area.

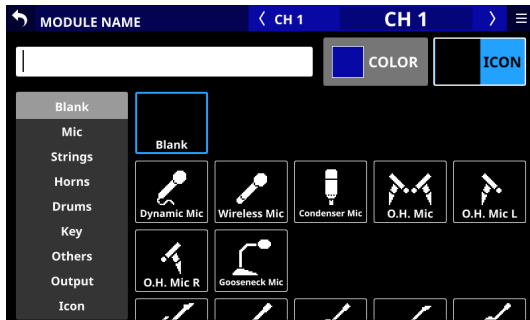

3. Tap an icon in the icon selection area to set it. Set icons will be shown on MODULE NAME and channel screens.

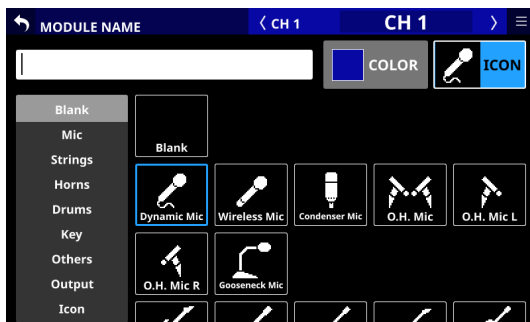

NOTE

- To select icons not shown on the screen, swipe the icon selection area up and down to scroll the screen. The screen can also be scrolled by tapping the icon categories on the left side of the screen.
- Tapping the keyboard input area on a NAME screen will reopen the keyboard.

8 – Saving and recalling setting data

Snapshot functions

Snapshots of unit mixer settings can be named and saved for recall at any time.

In addition to recalling them from the Snapshot List Screen, they can also be recall using USER KEY, FOOTSWITCH and GPIO-IN controls.

The following data is included in snapshots.

Input and output settings

- Routing settings (INPUT/OUTPUT)
- Internal oscillator input on/off
- Analog gain
- Pad on/off
- Phantom power on/off
- Phase button settings
- Digital trim value settings
- Direct out signal settings (on/off, trim, routing)
- Insert input/output settings (on/off, point, routing)
- Bus assignment settings (MIX bus, MAIN bus)
- Analog gain, pad on/off and phantom power on/off for mounted SB-16D units

Signal processing settings

- HPF parameters
- EQ parameters
- GEQ parameters
- Dynamics parameters
- Digital delay (delay time, on/off, point)
- Effect parameters
- Bus send settings (level, pre/post, pan/balance)
- Pan/balance settings, image, mode
- Fader/mute settings

Other module settings

- DCA/MUTE group settings
- Stereo link settings
- Bus mode settings (AUX/GROUP)
- Metering point settings
- Module name, color and icon settings

Other settings

- Internal oscillator settings (on/off, assignment, level, type, frequency)
- Talkback settings (phantom power on/off, digital trim value)
- Layer settings (layer key assignments, custom layer assignments, custom layer names for apps)
- Brightness settings for the various displays

This setting data is saved.

Moreover, when recalling snapshots, specified parameters can be protected so that they are not changed. (For example, routings can be kept the same when recalling snapshots.)

Using snapshot functions at the top of the Menu Screen

Snapshot functions can be conducted using the snapshot function area on the Menu Screen and from the Snapshot List Screen.

In this explanation, areas where snapshot data are saved are called “slots” or “data slots”.

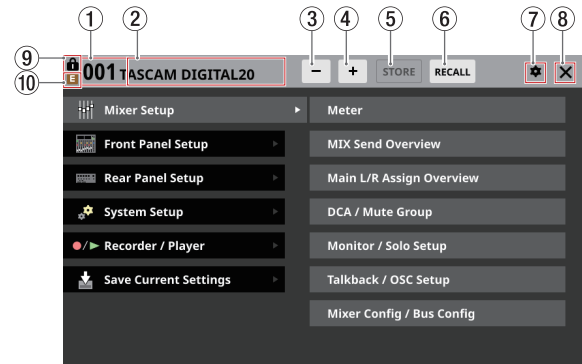

① Snapshot number

- This shows the number of the snapshot active for storing and recalling. This will blink if it is not the same as the current snapshot (most recently stored/recalled snapshot).
- Tap this area to open the Snapshot List Screen. (See “Snapshot List Screen” on page 174.)

② Snapshot name area

- This shows the name of the snapshot active for storing and recalling. This will blink if it is not the same as the current snapshot (most recently stored/recalled snapshot).
- Tap this area to open the Snapshot List Screen. (See “Snapshot List Screen” on page 174.)

③ Snapshot selection button

- Tap this button to switch to the snapshot that is one number lower, also switching to the corresponding name.
- Continuously touch this button to keep showing lower numbered snapshots.
- Tapping this when the snapshot number is “001” will show “P0xx”, which is the highest numbered preset.
- Tapping this when the snapshot number is “P001” will switch to “128”.

④ Snapshot selection button

- Tap this button to switch to the snapshot that is one number higher, also switching to the corresponding name.
- Continuously touch this button to keep showing higher numbered snapshots.
- Tapping this when the snapshot number is “128” will switch to “P001”.
- Tapping this when the snapshot number is “P0xx”, which is the highest numbered preset, will switch to “001”.

8 – Saving and recalling setting data

⑤ STORE button

- Tap this button to store (save) the current settings to the data slot shown. (See “Storing snapshots” on page 171.)
- If a locked data slot is shown, this button will appear gray.

⑥ RECALL button

- Tap this button to recall the data slot settings of the snapshot number/name shown. (See “Recalling snapshots” on page 172.)
- If an empty data slot is shown, this button will appear gray.

⑦ icon

Tap this icon to open the CONFIRMATION settings window.

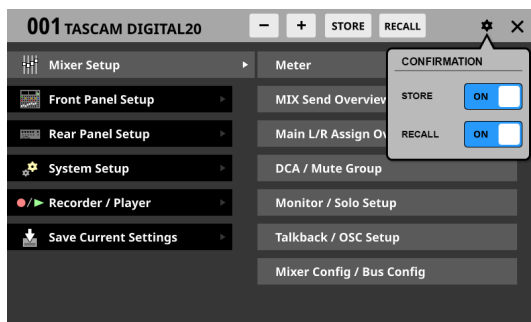

Tap these switches to set whether or not confirmation messages are shown when storing and recalling snapshots. Tap this button again to close the CONFIRMATION setting window.

NOTE

These settings can also be set on the PREFERENCES Screen. (See “PREFERENCES screen” on page 36.)

⑧ icon

Tap this icon to close the Menu Screen.

⑨ icon

This icon will appear if the snapshot shown is locked.



⑩ (EDIT) icon

This icon will appear if settings have been changed for the last stored/recalled (current) snapshot.

Storing snapshots

Follow one of the procedures below to store (save) snapshot data.

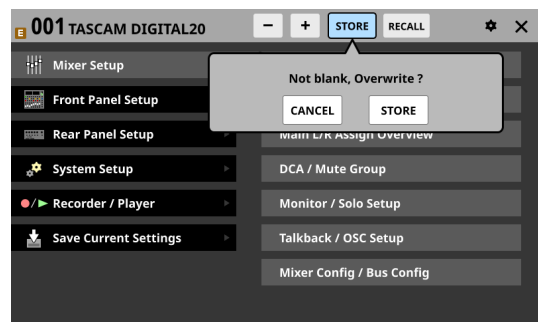

Using STORE at the top of the Menu Screen

1. Tap the / buttons to show the snapshot number (①)/name (②) of the save destination data slot.
2. Tap the STORE button (⑤).
 - If the save destination data slot is empty, the settings of the current snapshot will be stored in it.
 - If the save destination data slot is not empty and the CONFIRMATION settings window STORE setting is ON, a save confirmation message will be shown.



- Tapping the STORE button on the confirmation message will store the current snapshot settings in the data slot and close the message.
 - Tapping the CANCEL button on the confirmation message will close the message without storing.
3. After storing completes, a storing completion message will appear for about two seconds.

Storing snapshots on the Snapshot List Screen

1. Do one of the following to show the save destination data slot in the snapshot list display area.
 - Tap the / buttons
 - Turn LCD knob 8
 - Swipe the list up or down
 - Drag the scrollbar up or down
2. Tap the save destination data slot to select it. This highlights the data slot.
3. Tap the STORE button (⑤).
 - If the save destination data slot is empty, the settings of the current snapshot will be stored in it.
 - If the save destination data slot is not empty and the CONFIRMATION settings window STORE setting is ON, a save confirmation message will be shown.
 - Tapping the STORE button on the confirmation message will store the current snapshot settings in the data slot and close the message.
 - Tapping the CANCEL button on the confirmation message will close the message without storing.
4. After storing completes, a storing completion message will appear for about two seconds.

8 – Saving and recalling setting data

Storing using a control set on the USER DEFINED CONTROL Screen

If the Function and Parameter 1 settings on the USER DEFINED CONTROL Screen are as follows, the snapshot stored depends on the Parameter 2 setting.

| Function | Parameter1 |
|----------|------------|
| Snapshot | Store |

Pressing the control when Parameter 2 is set to "Selected"

This stores the current snapshot settings in the data slot shown by the snapshot number (①)/name (②) at the top of the Menu Screen.

Pressing the control when Parameter 2 is set to "No."

This stores the current snapshot settings in the data slot number specified by Parameter 3.

Pressing the control when Parameter 2 is set to "+Target Key"

Press simultaneously with a control that has Function set to Snapshot and Parameter 1 set to Target to store the current snapshot settings in the data slot number specified by Parameter 2 and Parameter 3 of that control.

However, even when Function is set to Snapshot and Parameter 1 is set to Target, this will not work if the key assigned to Parameter 2 as "Next" or "Prev" is pressed at the same time.

NOTE

Snapshot names when stored

- When stored, snapshots are automatically named based on the current snapshot name with additional data added as follows to make the generation clear.
 - 1st generation: base name
 - 2nd generation: base name+_XX (2-digit number)
 - 3rd generation: base name+_XX+a-z (single lowercase letter)

When a name cannot be added automatically,

| |
|---|
| Cannot generate default name automatically. Change name [CANCEL] [RENAME] |
|---|

will appear.

To change a name when storing, press the RENAME button to open the RENAME Screen.

Input a name that is not the same as existing data and tap Enter to store it.

- * Conditions that prevent names from being added automatically
 - The current snapshot has a 1st generation name and data named "currentname_99" already exists.
 - The current snapshot has a 2nd generation name with "_XX" added and data named "currentname_XXz" already exists.
 - The current snapshot has a 3rd generation name.
- When using a USER DEFINED CONTROL to store a snapshot, the name will be "USER KEY + data slot number".

Recalling snapshots

Follow one of the procedures below to recall (load) snapshot data.

Using RECALL at the top of the Menu Screen

- Tap the [-]/+ buttons to open the snapshot number (①)/name (②) of the data slot to be recalled.
- Tap the RECALL button (Ⓞ).
If the CONFIRMATION settings window RECALL setting is ON, a confirmation message will be shown.
 - Tapping the RECALL button on the confirmation message will recall the snapshot and close the message.
 - Tapping the CANCEL button on the confirmation message will close the message without recalling.
- After recalling completes, a recall completion message will appear for about two seconds.

Recalling snapshots on the Snapshot List Screen

- Do one of the following to show the data slot to be recalled in the snapshot list display area.
 - Tap the [-]/+ buttons
 - Turn LCD knob 8
 - Swipe the list up or down
 - Drag the scrollbar up or down
- Tap the data slot to be recalled to select it.
This highlights the data slot.
- Tap the RECALL button (Ⓞ).
If the CONFIRMATION settings window RECALL setting is ON, a confirmation message will be shown.
 - Tapping the RECALL button on the confirmation message will recall the snapshot and close the message.
 - Tapping the CANCEL button on the confirmation message will close the message without recalling.
- After recalling completes, a recall completion message will appear for about two seconds.

Recalling using a control set on the USER DEFINED CONTROL Screen

If the Function and Parameter 1 settings on the USER DEFINED CONTROL Screen are as follows, the snapshot recalled depends on the Parameter 2 setting.

| Function | Parameter1 |
|----------|------------|
| Snapshot | Recall |

8 – Saving and recalling setting data

Pressing the control when Parameter 2 is set to “Selected”

This recalls the settings in the data slot shown by the snapshot number (①)/name (②) at the top of the Menu Screen.

Pressing the control when Parameter 2 is set to “Next” or “Prev”

This recalls the settings stored in the data slot one before/after (excluding presets) the snapshot shown by the number (①)/name (②) at the top of the Menu Screen.

Pressing the control when Parameter 2 is set to “No.”

This recalls the settings in the data slot number specified by Parameter 3.

Pressing the control when Parameter 2 is set to “+Target Key”

Press simultaneously with a control that has Function set to Snapshot and Parameter 1 set to Target to recall the settings in the data slot number specified by Parameter 2 and Parameter 3 of that control.

NOTE

Limitations on recalling snapshot data from a different model (Sonicview 16/Sonicview 24)

When recalling snapshot data from a different model, a confirmation message like the following will be shown.

Message when recalling Sonicview 16 snapshot data on a Sonicview 24

| | |
|--|-------------------|
| This is Sonicview 16 data. Some parameters cannot be recalled. Recall this data? | [CANCEL] [RECALL] |
|--|-------------------|

Tap the RECALL button to recall. When recalling, compatible settings will be recalled as is. The following incompatible settings will be handled as shown.

| | Snapshot settings that are not compatible between Sonicview 24 and Sonicview 16 models | When recalling Sonicview 24 data on a Sonicview 16 | When recalling Sonicview 16 data on a Sonicview 24 | | | | | | | | | | | | | | | | | | | | | | | | | | | | | | | | | | | | | | | | | | | | | | | | | | | | | | |
|---|---|--|---|------------------------------------|------------------------------------|------------------------------------|------------------------------------|---------|---------|---------|-----------|---------|-----------|----------|------------------------|------------------------|------------|----------|-----------|------------------------|----------|-------------------|------------|------------------------|--------------------------|----------|--|---------|-----------|----------|---------------------|-----------|--|---------------------|-----------------------|--------------------|---------------------|--|--|-----|-------|---------|-----------|--|--|--|--|---------------------|-----------------------|--|--|--|--|-----|-------|--|--|
| 1 | Analog input 17–24 settings | | | | | | | | | | | | | | | | | | | | | | | | | | | | | | | | | | | | | | | | | | | | | | | | | | | | | | | | |
| | M/L 17–24 Input Assign | Not imported | No assignment | | | | | | | | | | | | | | | | | | | | | | | | | | | | | | | | | | | | | | | | | | | | | | | | | | | | | | |
| | M/L 17–24 Phantom ON/OFF | Not imported | Set to OFF | | | | | | | | | | | | | | | | | | | | | | | | | | | | | | | | | | | | | | | | | | | | | | | | | | | | | | |
| | M/L 17–24 PAD ON/OFF | Not imported | Set to OFF | | | | | | | | | | | | | | | | | | | | | | | | | | | | | | | | | | | | | | | | | | | | | | | | | | | | | | |
| 2 | M/L 17–24 Analog GAIN | Not imported | Set to minimum value | | | | | | | | | | | | | | | | | | | | | | | | | | | | | | | | | | | | | | | | | | | | | | | | | | | | | | |
| | Fader 17–24 settings Fader 17–24 Custom Layer Mapping | Not imported | No assignment | | | | | | | | | | | | | | | | | | | | | | | | | | | | | | | | | | | | | | | | | | | | | | | | | | | | | | |
| 3 | Layer Key Assign | Converted and imported as follows (re-creating original data as much as possible) | Converted and imported as follows (re-creating original data as much as possible) | | | | | | | | | | | | | | | | | | | | | | | | | | | | | | | | | | | | | | | | | | | | | | | | | | | | | | |
| | <table border="1"> <thead> <tr> <th>Sonicview 16 Preset Layer</th> <th>Sonicview 24 Preset Layer</th> <th>Recalled Sonicview 24 data</th> <th>Sonicview 16 settings after recall</th> <th>Recalled Sonicview 16 data</th> <th>Sonicview 24 settings after recall</th> </tr> </thead> <tbody> <tr> <td>CH 1–16</td> <td>CH 1–24</td> <td>CH 1–24</td> <td>→ CH 1–16</td> <td>CH 1–16</td> <td>→ CH 1–24</td> </tr> <tr> <td>CH 17–32</td> <td>CH 25–40/ST IN/ FX RTN</td> <td>CH 25–40/ST IN/ FX RTN</td> <td>→ CH 17–32</td> <td>CH 17–32</td> <td>→ CH 1–24</td> </tr> <tr> <td>CH 33–40/ST IN/ FX RTN</td> <td>MIX 1–22</td> <td>MIX 1–22/MAIN L/R</td> <td>→ MIX 1–16</td> <td>CH 33–40/ST IN/ FX RTN</td> <td>→ CH 25–40/ST IN/ FX RTN</td> </tr> <tr> <td>MIX 1–16</td> <td></td> <td>DCA 1–8</td> <td>→ DCA 1–8</td> <td>MIX 1–16</td> <td>→ MIX 1–22/MAIN L/R</td> </tr> <tr> <td>MIX 17–22</td> <td></td> <td>CUSTOM 1 – CUSTOM 7</td> <td>→ CUSTOM 1 – CUSTOM 7</td> <td>MIX 17–22/MAIN L/R</td> <td>→ MIX 1–22/MAIN L/R</td> </tr> <tr> <td></td> <td></td> <td>---</td> <td>→ ---</td> <td>DCA 1–8</td> <td>→ DCA 1–8</td> </tr> <tr> <td></td> <td></td> <td></td> <td></td> <td>CUSTOM 1 – CUSTOM 7</td> <td>→ CUSTOM 1 – CUSTOM 7</td> </tr> <tr> <td></td> <td></td> <td></td> <td></td> <td>---</td> <td>→ ---</td> </tr> </tbody> </table> | Sonicview 16 Preset Layer | Sonicview 24 Preset Layer | Recalled Sonicview 24 data | Sonicview 16 settings after recall | Recalled Sonicview 16 data | Sonicview 24 settings after recall | CH 1–16 | CH 1–24 | CH 1–24 | → CH 1–16 | CH 1–16 | → CH 1–24 | CH 17–32 | CH 25–40/ST IN/ FX RTN | CH 25–40/ST IN/ FX RTN | → CH 17–32 | CH 17–32 | → CH 1–24 | CH 33–40/ST IN/ FX RTN | MIX 1–22 | MIX 1–22/MAIN L/R | → MIX 1–16 | CH 33–40/ST IN/ FX RTN | → CH 25–40/ST IN/ FX RTN | MIX 1–16 | | DCA 1–8 | → DCA 1–8 | MIX 1–16 | → MIX 1–22/MAIN L/R | MIX 17–22 | | CUSTOM 1 – CUSTOM 7 | → CUSTOM 1 – CUSTOM 7 | MIX 17–22/MAIN L/R | → MIX 1–22/MAIN L/R | | | --- | → --- | DCA 1–8 | → DCA 1–8 | | | | | CUSTOM 1 – CUSTOM 7 | → CUSTOM 1 – CUSTOM 7 | | | | | --- | → --- | | |
| | Sonicview 16 Preset Layer | Sonicview 24 Preset Layer | Recalled Sonicview 24 data | Sonicview 16 settings after recall | Recalled Sonicview 16 data | Sonicview 24 settings after recall | | | | | | | | | | | | | | | | | | | | | | | | | | | | | | | | | | | | | | | | | | | | | | | | | | | |
| | CH 1–16 | CH 1–24 | CH 1–24 | → CH 1–16 | CH 1–16 | → CH 1–24 | | | | | | | | | | | | | | | | | | | | | | | | | | | | | | | | | | | | | | | | | | | | | | | | | | | |
| | CH 17–32 | CH 25–40/ST IN/ FX RTN | CH 25–40/ST IN/ FX RTN | → CH 17–32 | CH 17–32 | → CH 1–24 | | | | | | | | | | | | | | | | | | | | | | | | | | | | | | | | | | | | | | | | | | | | | | | | | | | |
| | CH 33–40/ST IN/ FX RTN | MIX 1–22 | MIX 1–22/MAIN L/R | → MIX 1–16 | CH 33–40/ST IN/ FX RTN | → CH 25–40/ST IN/ FX RTN | | | | | | | | | | | | | | | | | | | | | | | | | | | | | | | | | | | | | | | | | | | | | | | | | | | |
| | MIX 1–16 | | DCA 1–8 | → DCA 1–8 | MIX 1–16 | → MIX 1–22/MAIN L/R | | | | | | | | | | | | | | | | | | | | | | | | | | | | | | | | | | | | | | | | | | | | | | | | | | | |
| | MIX 17–22 | | CUSTOM 1 – CUSTOM 7 | → CUSTOM 1 – CUSTOM 7 | MIX 17–22/MAIN L/R | → MIX 1–22/MAIN L/R | | | | | | | | | | | | | | | | | | | | | | | | | | | | | | | | | | | | | | | | | | | | | | | | | | | |
| | | | --- | → --- | DCA 1–8 | → DCA 1–8 | | | | | | | | | | | | | | | | | | | | | | | | | | | | | | | | | | | | | | | | | | | | | | | | | | | |
| | | | | | CUSTOM 1 – CUSTOM 7 | → CUSTOM 1 – CUSTOM 7 | | | | | | | | | | | | | | | | | | | | | | | | | | | | | | | | | | | | | | | | | | | | | | | | | | | |
| | | | | --- | → --- | | | | | | | | | | | | | | | | | | | | | | | | | | | | | | | | | | | | | | | | | | | | | | | | | | | | |
| | | ATTENTION Be aware that the following will be discarded in this case. <ul style="list-style-type: none"> • CH 33–40/ST IN/ FX RTN • MIX 17–22/MAIN L/R | | | | | | | | | | | | | | | | | | | | | | | | | | | | | | | | | | | | | | | | | | | | | | | | | | | | | | | |

8 – Saving and recalling setting data

Snapshot List Screen

Conduct snapshot function operations and setting data management and editing on this screen.

In this explanation, areas where snapshot and library data are saved are called “slots” or “data slots”.

Open this screen by tapping the snapshot number/name area at the top left of the Menu Screen.

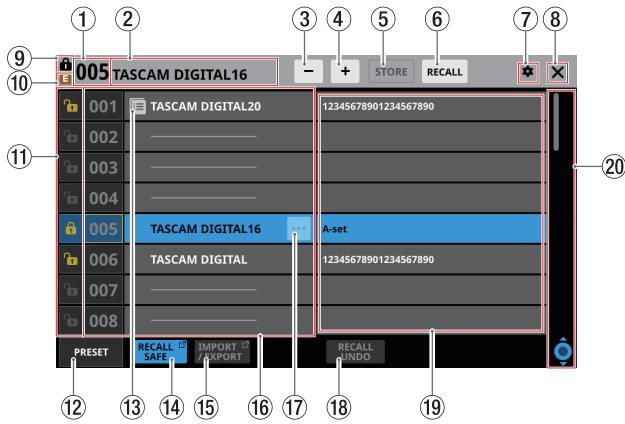

① Snapshot number

This shows the number of the snapshot active for storing and recalling.

This will blink if it is not the same as the current snapshot (most recently stored/recalled snapshot).

② Snapshot name area

This shows the name of the snapshot active for storing and recalling.

This will blink if it is not the same as the current snapshot (most recently stored/recalled snapshot).

③ Snapshot selection button

This has the same function as the Snapshot selection button on the Menu Screen.

④ Snapshot selection button

This has the same function as the Snapshot selection button on the Menu Screen.

⑤ STORE button

This has the same function as the STORE button on the Menu Screen.

⑥ RECALL button

This has the same function as the RECALL button on the Menu Screen.

⑦ icon

This has the same function as the icon on the Menu Screen.

⑧ icon

Tap this icon to close the Snapshot List Screen and return to the Menu Screen.

⑨ icon

This has the same function as the icon on the Menu Screen.

⑩ (EDIT) icon

This has the same function as the icon on the Menu Screen.

⑪ LOCK/UNLOCK buttons

- These show the locked/unlocked states of the data slots.

| Button | Use |
|--------|----------|
| | Unlocked |
| | Locked |

If setting data has not been saved in a slot, it will appear gray.

- Tap a / icon to open a LOCK/UNLOCK switching window for the data slot.

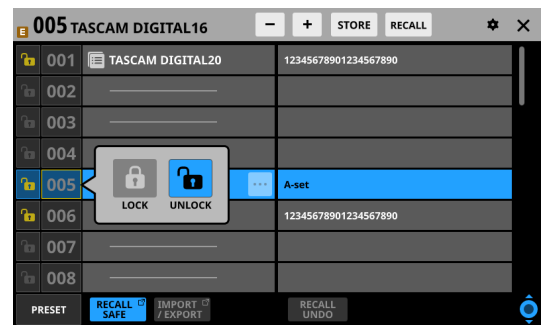

Tap a LOCK/UNLOCK option to switch the status.

- Locked data slots cannot be deleted, renamed, overwritten and stored, or pasted into.

⑫ PRESET button

Tap this button to move to the preset data (P001-) location in the snapshot list.

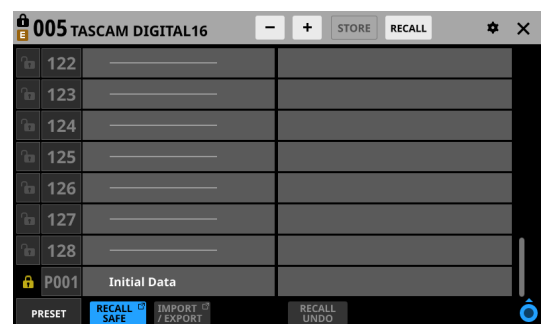

8 – Saving and recalling setting data

⑬ icon

This icon is shown for data slots that have had snapshots setting data copied to the internal storage.

NOTE

The  icon is shown until new snapshot setting data is copied or until the unit power is turned off. The icon will also disappear if the copy source is deleted, overwritten or renamed.

⑭ **RECALL SAFE button**

- This shows the Recall Safe setting status. If any are set to Recall Safe, this button will be highlighted.
- Tap this button to open the SNAPSHOT RECALL SAFE Screen where settings that will be protected (retained) when snapshots are recalled can be selected. (See “SNAPSHOT RECALL SAFE screen” on page 178.)

⑮ **IMPORT/EXPORT button**

Tap this button to open the SNAPSHOT IMPORT/EXPORT Screen. (See “SNAPSHOT IMPORT / EXPORT screen” on page 179.)

⑯ **Snapshot list**

- This shows snapshot numbers and names.
- Data slots without any saved data are shown with horizontal bars.
- The selected data slot will be highlighted.
- “P” is added before the numbers of preset snapshots.
- A yellow frame will be shown around the number of the current snapshot (most recently stored/recalled snapshot).

⑰ **Snapshot editing menu button**

- This button only appears for the selected data slot.
- Tap this button to open a menu for editing the selected data slot.

⑱ **RECALL UNDO/REDO button**

Tap this button to undo/redo snapshot recall. RECALL UNDO cancels the last snapshot recall and restores settings to their state before the recall. RECALL REDO cancels the undo operation and restores settings to their state before the undo.

⑲ **Comments**

This shows the contents input in the COMMENT field on the RENAME Screen, which is opened by tapping the Rename button in the snapshot editing menu.

This shows as much of the added comments as possible from their beginnings.

Two lines will be shown if the content does not fit on one line. If the content still does not fit, the second line will end with ...

⑳ **Scroll knob and scrollbar**

Drag the scrollbar to scroll the screen. The Snapshot List (⑯) and Comments (⑲) can also be scrolled by swiping up and down as well as by turning LCD knob 8.

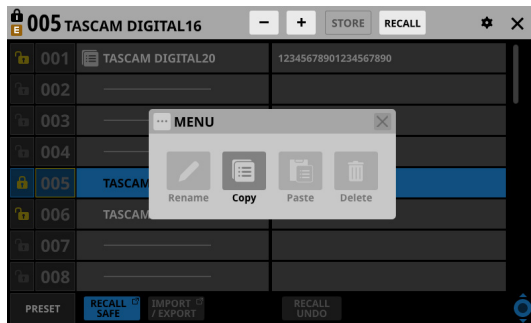

See “Library menu” on page 176 for details.

8 – Saving and recalling setting data

Library menu

Use this to edit library data.

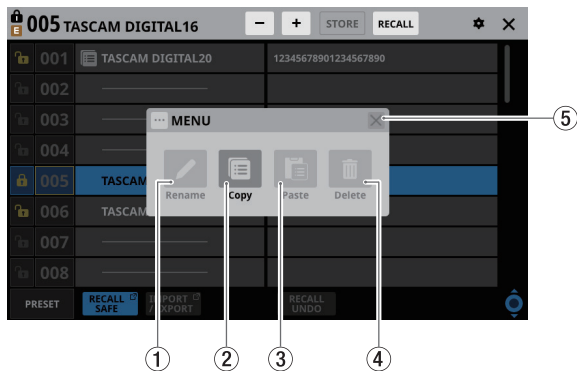

These buttons will be gray when they cannot be used.

① Rename button

Tap this button to open the RENAME Screen. If the current data slot is locked or setting data has not been saved in it, this will appear gray.



- For snapshots, a comment field that can be edited will appear on the right side.
- The combination of characters input can be changed depending on the status of the Caps lock and Shift keyboard buttons on the RENAME Screen. See “Changing the keyboard keys” on page 167 for details about changing the keyboard.

ATTENTION

The following symbols and punctuation marks cannot be input.

¥ / . * ? " < > |

NOTE

A USB keyboard connected to the top panel USB port can also be used to input and edit characters.

② Copy button

Tap this button to copy the settings data of the selected snapshot.

NOTE

The LIBRARY Screen for snapshots is the only one that has Copy and Paste functions.

③ Paste button

Tap this button to paste the settings data of the copied snapshot to the selected data slot. This will appear gray for locked snapshots.

NOTE

The LIBRARY Screen for snapshots is the only one that has Copy and Paste functions.

④ Delete button

Tap this button to open a confirmation message for deleting the selected data. If the current data slot is locked or setting data has not been saved in it, this will appear gray.

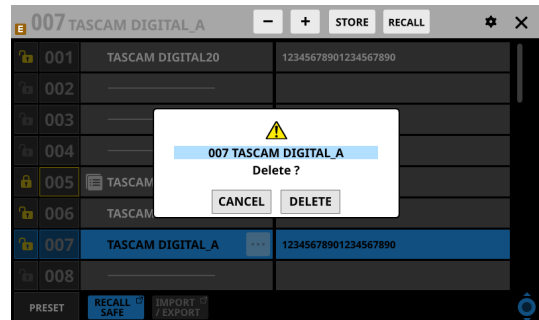

- Tap the CANCEL button to close the confirmation message.
- Tapping the DELETE button will delete the selected data and close the confirmation message.

⑤ X button

Tap this button to close the Library Menu.

8 – Saving and recalling setting data

Copying snapshots

1. Select the snapshot to copy and tap the snapshot editing menu button (☰).

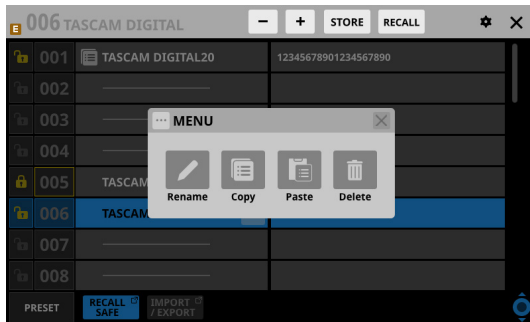

2. Tap the Copy button.
An  icon will appear next to the copied snapshot.

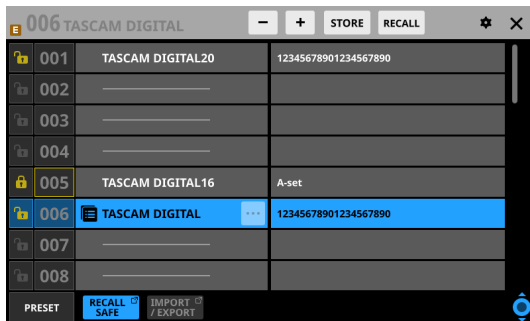

3. Select the data slot where it will be pasted and tap the snapshot editing menu button (☰).

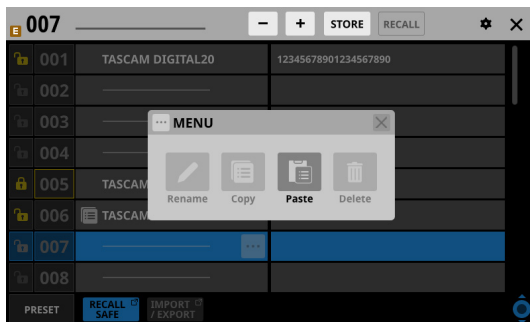



4. Tap the Paste button to paste it with a name given according to the snapshot storage rules. (See “ STORE button” on page 171.)
When a name cannot be added automatically, the RENAME screen will open. In this case, input a name that is not the same as existing data and tap the Enter button to paste and return to the Snapshot List Screen.

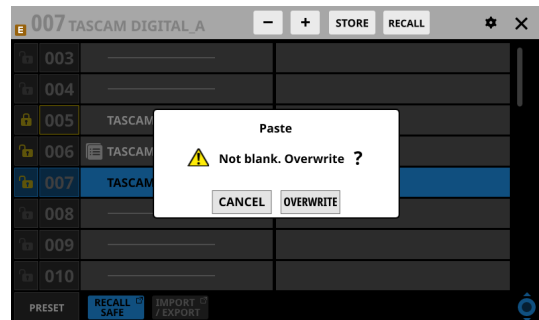

NOTE

- When snapshot setting data is saved in the paste destination, a confirmation message will be shown.



- Tap the CANCEL button to close the confirmation message.
- Tap the OVERWRITE button to paste it with a name given according to the snapshot storage rules. (See “ STORE button” on page 171.)
When a name cannot be added automatically, the RENAME screen will open. In this case, input a name that is not the same as existing data and tap the Enter button to paste and return to the Snapshot List Screen.
- The  icon is shown until new snapshot setting data is copied or until the unit power is turned off. The icon will also disappear if the copy source is deleted, overwritten or renamed.

8 – Saving and recalling setting data

SNAPSHOT RECALL SAFE screen

The following settings can be made on this screen.

- **PARAMETER SAFE** page
Use this to select parameters that will be protected (settings retained) when snapshots are recalled.
- **MODULE SAFE** page
Use this to select modules that will be protected (settings retained) when snapshots are recalled.

Tap the RECALL SAFE button on the Snapshot List Screen to open this screen.

PARAMETER SAFE page

The recall safe function can be activated for specific groups of settings on this page.

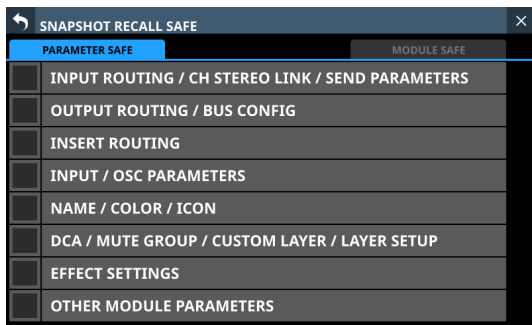

Tap checkboxes in rows to activate the recall safe function for them.

Selected rows will have check marks (✓) and be highlighted light blue.

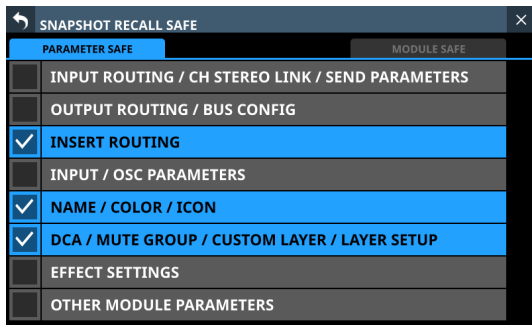

NOTE

- Settings included in INPUT/OSC PARAMETERS
 - Analog Gain
 - Analog Gain GANG On/Off
 - PAD On/Off
 - Phantom On/Off
 - Phase
 - D.Trim
 - HPF Freq
 - HPF On/Off
 - CH OSC INPUT
 - OSC On/Off
 - OSC Assign
 - OSC Level
 - OSC Type
 - OSC Freq

- Settings included in OTHER MODULE PARAMETERS
 - Gate/Expander/De-Esser Parameters
 - EQ Parameters
 - GEQ Parameters
 - Comp/Ducker Parameters
 - Module Delay Parameters
 - Fader
 - Mute
 - MAIN L/R Assign
 - PAN/BAL
 - PAN LINK
 - Image
 - Mode
 - Direct Out Parameters
 - Talkback Phantom On/Off
 - Talkback D.Trim
 - Metering Point
 - LCD Brightness

MODULE SAFE page

The recall safe function can be activated for modules on this page.

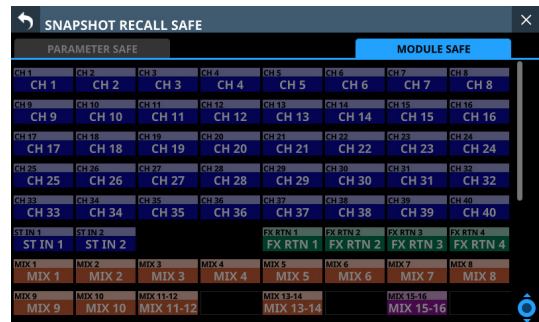

Tap the buttons for modules to be selected for recall safe protection.

Selected module buttons will be highlighted and have yellow frames.

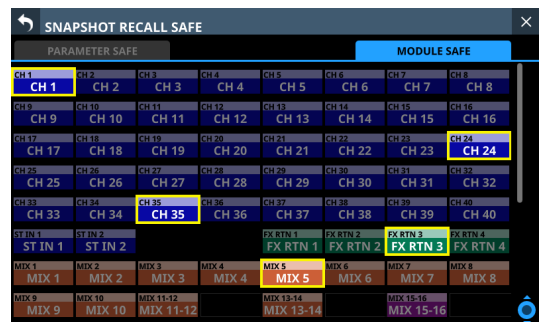

8 – Saving and recalling setting data

SNAPSHOT IMPORT / EXPORT screen

On the screen, snapshot settings data in this unit's internal storage can be exported to loaded SD cards and USB flash drives. This data can also be imported from these external storage devices.

Tap the IMPORT/EXPORT button on the Snapshot List Screen to open this screen.

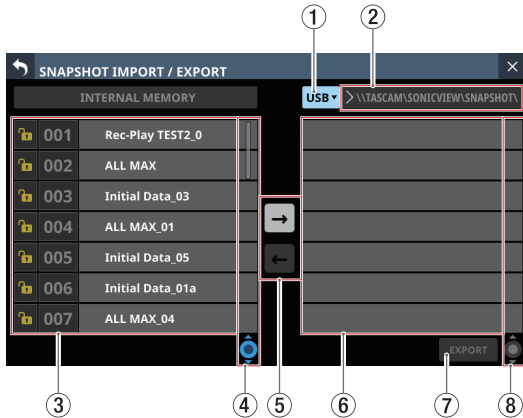

① Media selection button

- This shows the name of the currently selected media.
- Tap this button to open a window where the import source/export destination can be set.

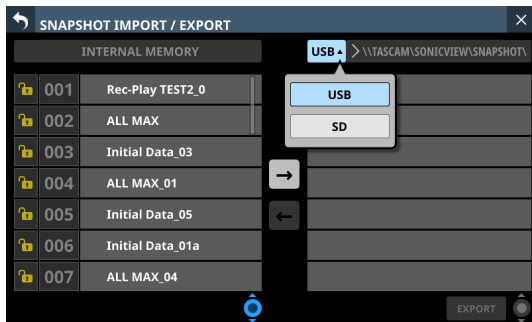

Options: USB, SD

Tap an option to switch the import source/export destination.

② Folder

This shows the import source/export destination folder name.

The following folder on the external media is the import source/export destination folder.

\\TASCAM\SONICVIEW\SNAPSHOT

③ Snapshot list

This is a list of snapshots in the unit's internal storage.

④ Snapshot List scroll knob and scrollbar

Drag the scrollbar to scroll the screen. The Snapshot List (③) can also be scrolled by swiping up and down as well as by turning LCD knob 4.

⑤ IMPORT/EXPORT mode buttons

- Tap the (right arrow) button to switch the screen to export mode. The button will be highlighted () when switched to export mode.
- Tap the (left arrow) button to switch the screen to import mode. The button will be highlighted () when switched to import mode.

NOTE

The unit will be set to export mode when it is turned on. After switching the setting, the last selected state will be retained until the unit is turned off.

⑥ List of data on selected media

This is a list of snapshot data on the selected media. If the selected media type is not loaded, the following message will appear in the data list area.



⑦ IMPORT/EXPORT button

- The button shown depends on the setting of the IMPORT/EXPORT mode button (⑤).
- When in import mode, the button will be highlighted if both the import source and destination have been selected.
- When in export mode, the button will be highlighted if the snapshot to be exported has been selected.
- Tap this button when highlighted to execute the import/export operation.

⑧ Export data list scroll knob and scrollbar

- If the number of snapshots on the selected media cannot all be shown on the screen at once, the scrollbar will appear and the scroll knob will be highlighted.
- Drag the scrollbar to scroll the screen.
- The list of data on the selected media (⑥) can also be scrolled by swiping up and down as well as by turning LCD knob 8.

8 – Saving and recalling setting data

Exporting snapshots

1. Tap the snapshot name area (②) on the Menu Screen to open the Snapshot List Screen. (See “Snapshot List Screen” on page 174.)
2. Tap the IMPORT/EXPORT button on the Snapshot List Screen to open the SNAPSHOT IMPORT/EXPORT Screen. (See “SNAPSHOT IMPORT / EXPORT screen” on page 179.)
3. Connect the export destination media.
4. Use the media selection button (①) to select the media to use as the export destination. (See “① Media selection button” on page 179.)
5. Tap the EXPORT/IMPORT mode (⑤) button to switch to export mode.

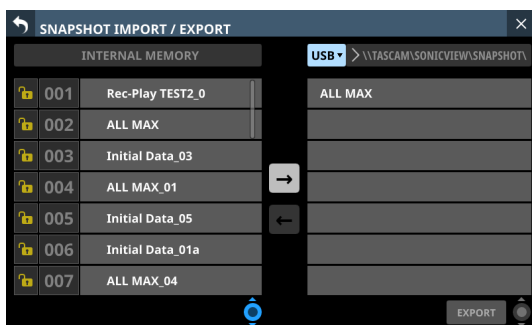

6. In the list of snapshots in the unit's internal storage (③), tap the snapshot data to be exported. The snapshot data to be exported and the EXPORT button will be highlighted.

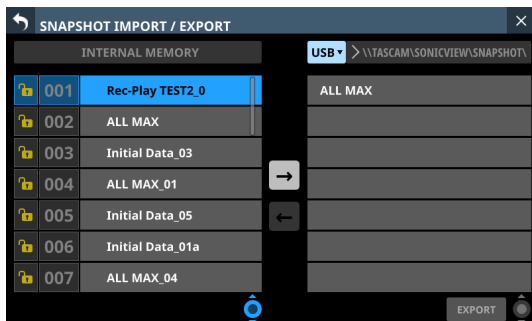

7. Tap the EXPORT button. The exported snapshot data will be added to the exported data list (⑥), and an export complete message will appear at the top of the screen.



NOTE

- A confirmation message will be shown if snapshot data with the same name already exists on the export destination media.

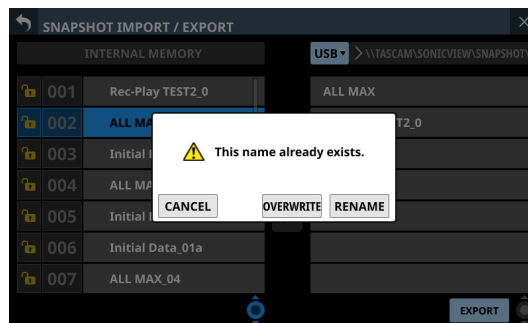

- Tap the CANCEL button to cancel exporting and close the confirmation message.
- Tap the OVERWRITE button to overwrite the data of the snapshot with the same name and close the confirmation message.
- Tap the RENAME button to open the RENAME Screen. Input a name that is not the same as an existing snapshot name. Then, tap the Enter button to execute the export and return to the SNAPSHOT IMPORT/EXPORT Screen.
- The following message will be shown if the export destination media is a locked SD card.

Cannot Export. SD card Locked.

- One of the following messages will be shown if the export destination media does not have enough open space.

Cannot Export. SD card is full.

Cannot Export. USB memory is full.

Importing snapshots

ATTENTION

If a snapshot created on a unit with firmware version 1.1.0 or later is recalled by a unit with firmware version 1.0.x, proper operation will not be possible, so the following restriction applies.

- Snapshots created on units with firmware version 1.1.0 or later cannot be imported by units with firmware version 1.0.x. (Snapshots created by units with firmware version 1.0.x can be imported by units with firmware version 1.1.0 or later.)

1. Tap the snapshot name area (②) on the Menu Screen to open the Snapshot List Screen. (See “Snapshot List Screen” on page 174.)
2. Tap the IMPORT/EXPORT button on the Snapshot List Screen to open the SNAPSHOT IMPORT/EXPORT Screen. (See “SNAPSHOT IMPORT / EXPORT screen” on page 179.)

8 – Saving and recalling setting data

3. Connect the import source media.
4. Use the media selection button (①) to select the media to use as the import source. (See “① Media selection button” on page 179.)
5. Tap the EXPORT/IMPORT mode button (⑤) to switch to import mode.

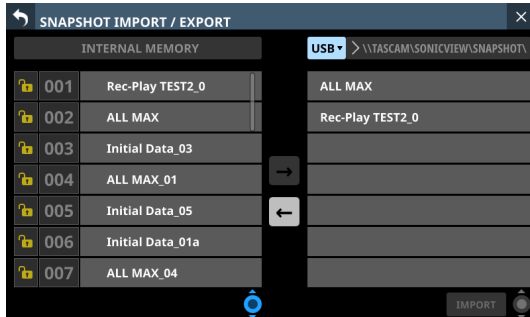

7. After selecting the desired folder, tap the “∨” at the left end of the folder selection button to close the folder selection pull-down menu.
8. In the list of data on the selected media (⑥), tap the snapshot data to be imported. The snapshot data to be imported will be highlighted.

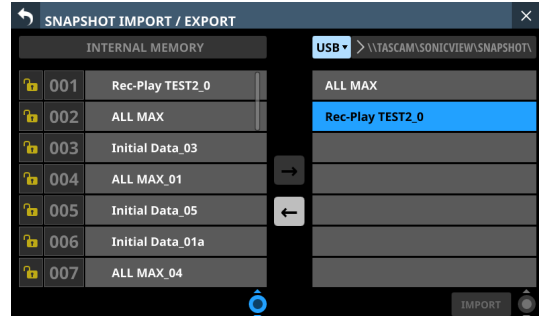

6. If the list of data on the selected media (⑥) has no snapshot data that you want to import, tap the folder selection button to the right of the media selection button to open the folder selection menu.
 - If the entire pull-down menu cannot be shown on the display, use LCD knob 8, the scrollbar or swipe gestures to scroll the screen.
 - Tap “>” to the left of a folder name to open that folder and show its contents.
 - Tap “∨” to the left of the name of a folder to close it.
 - Tap the name of a folder to select it.
 - The name of the selected folder is reflected in the folder selection button path display field.

9. In the list of snapshots in the unit’s internal storage (③), tap the input destination data slot. The import destination data slot and the IMPORT button will appear highlighted.

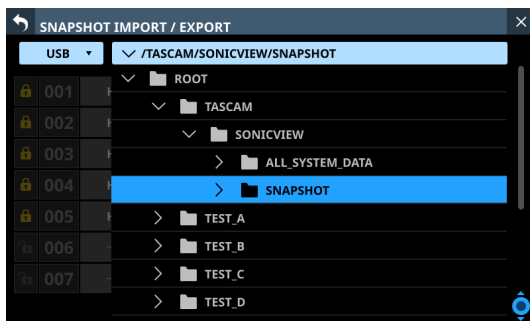
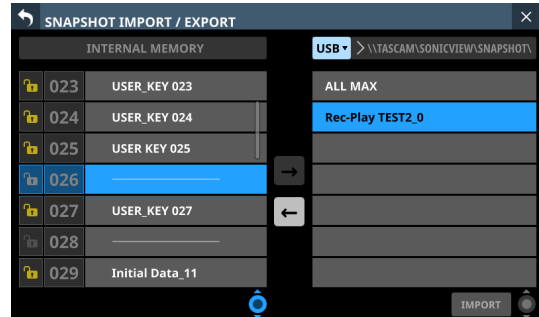

Folder selection pull-down menu example

8 – Saving and recalling setting data

10. Tap the IMPORT button.

The imported snapshot data will be added to the snapshot list (③).

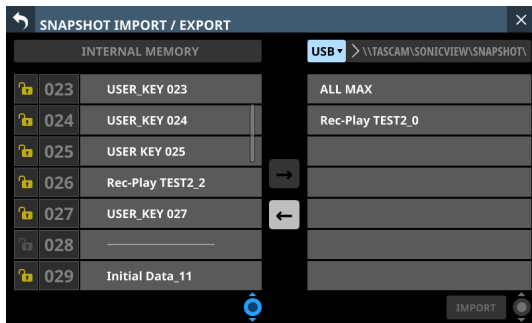

NOTE

- An OVERWRITE confirmation message will be shown if snapshot data with the same name as the import source already exists in the import destination data slot.

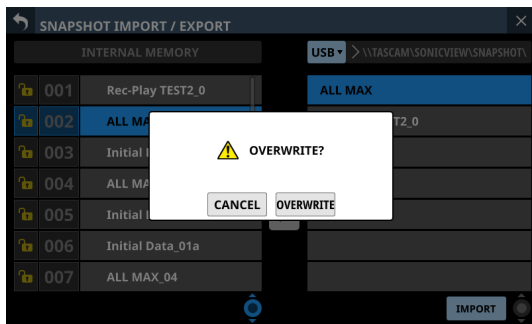

A REPLACE confirmation message will be shown if snapshot data with a different name from the import source exists in the import destination data slot.

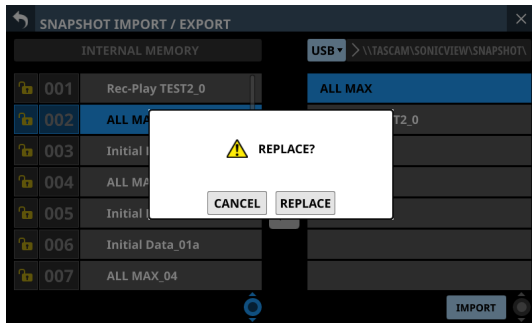

- Tap the CANCEL button to cancel importing and close the confirmation message.
- Tap the OVERWRITE button to import and overwrite the data of the snapshot with the same name and close the confirmation message.
- Tap the REPLACE button to import and overwrite snapshot data with a different name and close the confirmation message.
- The following message will be shown if the import destination slot is locked.

Cannot Import. Target Locked.

Various LIBRARY Screens

This unit can store (save) and recall groups of various settings in libraries.

- The selected GATE/EXPANDER/DE-ESSER type and its parameter settings
- EQ parameter settings
- The selected COMP/DUCKER type and its parameter settings
- The selected FX type and its parameter settings
- GEQ parameter settings
- CH 1–40 and ST IN 1–2 module parameter settings
- FX RTN 1–4 module parameter settings
- MIX 1–22 and MAIN L/R Master module parameter settings

Tap the LIBRARY button on the GATE/EXP/DE-ESSER, EQ, COMP/DUCKER, FX or GEQ module screen to open the corresponding LIBRARY Screen.

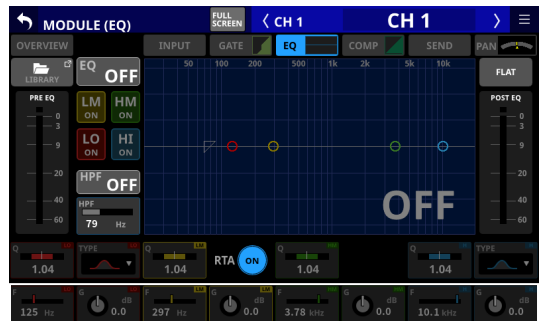

CH 1–40 MODULE (EQ) Screen

To open LIBRARY screens (LIBRARY MODULE INPUT, LIBRARY MODULE FX RTN and LIBRARY MODULE OUTPUT screens) for modules, tap the button at the top right of a MODULE Screen. Then, tap MODULE Library in the menu list that appears.

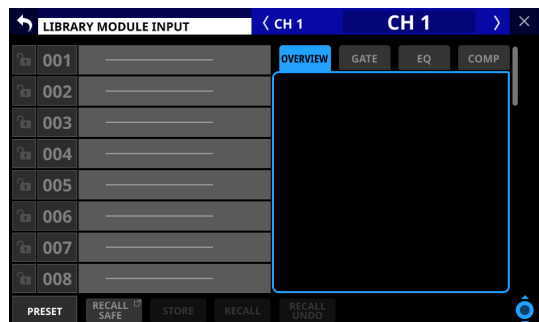
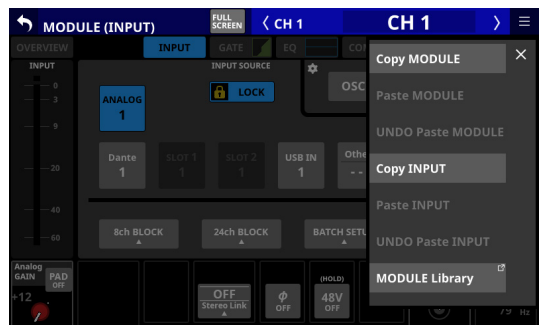

The parameters included in module libraries are the same as the parameters used for Copy MODULE. (See “MODULE menu” on page 150.)

8 – Saving and recalling setting data

LIBRARY screen overview

Use various library functions and manage and edit library data on these screens.

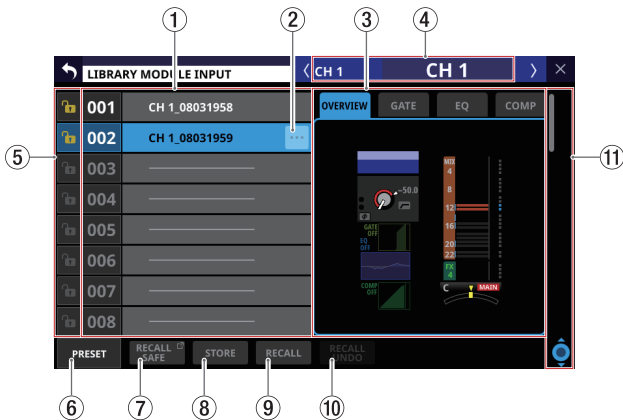

① Library list

- This shows library item numbers and names.
- Data slots without any saved data are shown with horizontal bars.
- The selected data slot will be highlighted.
- "P" is added before the numbers of library presets.

② LIBRARY menu button (⋮)

- This button only appears for the selected data slot.
- Tap this button to open the library menu for editing the selected data slot.



See "Library menu" on page 176 for details.

③ Preview display

This shows a preview of the selected library data. For module libraries, tap the tabs to change the preview contents.

④ Corresponding module name

This shows the name of the module active for library storing and recalling.

⑤ LOCK/UNLOCK buttons

- These show the locked/unlocked states of the data slots.

| Button | Use |
|--------|----------|
| | Unlocked |
| | Locked |

If setting data has not been saved in a slot, it will appear gray.

- Tap a / icon to open a LOCK/UNLOCK switching window for the data slot.

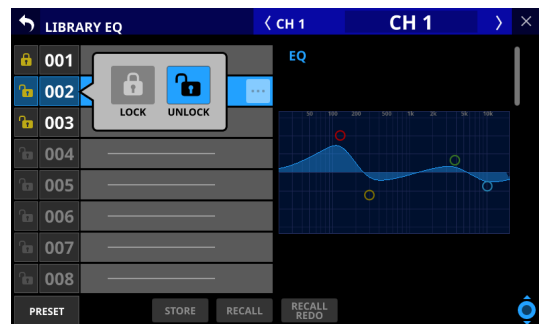

Tap a LOCK/UNLOCK option to switch the status.

- Locked data slots cannot be deleted, renamed, or overwritten and stored.

⑥ PRESET button

Tap this button to move to the preset data (P001–) location in the library list.

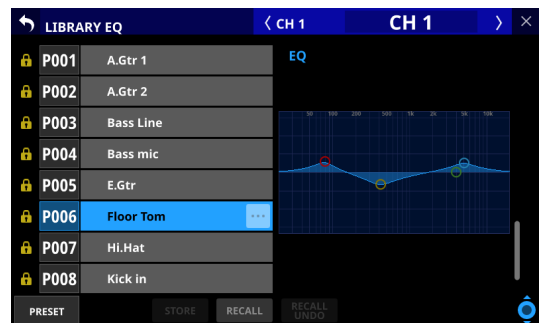

⑦ RECALL SAFE button

- This is shown for module libraries.
- This shows the Recall Safe setting status. If any are set to Recall Safe, this button will be highlighted.
- Tap this button to open the MODULE RECALL SAFE Screen where settings that will be protected (retained) when module libraries are recalled can be selected. (See "MODULE RECALL SAFE screens" on page 185.)

8 – Saving and recalling setting data

⑧ STORE button

- Tap this button after selecting a data slot to store the currently selected module settings to that data slot.
- If no data slot is selected or locked library data is selected, this button will appear gray.
- Library data names when stored are as follows.

EQ/GEQ Library

Module name_month day hour minute

Example: CH1_06091557, Vocal_06091558

Dynamics Library

| | |
|--|---|
| When a user-defined module name has been set | Module name_month day hour minute (for example, "Vocal_06091558") |
| When a user-defined module name has not been set | Dynamics type_month day hour minute (without spaces) (for example, "GATE_06091557") |

FX Library

FX TYPE name_month day hour minute (without spaces)

Example: REVERB_06091557, ST REV_06091558

Module Library

Module name_month day hour minute

Example: CH1_06091557, Vocal_06091558

NOTE

- If the data name when storing is the same as an existing data name, the following message will be shown.

Default name already exists.
change name.
[CANCEL] [RENAME]

- A confirmation message will be shown if the selected data slot has settings data.

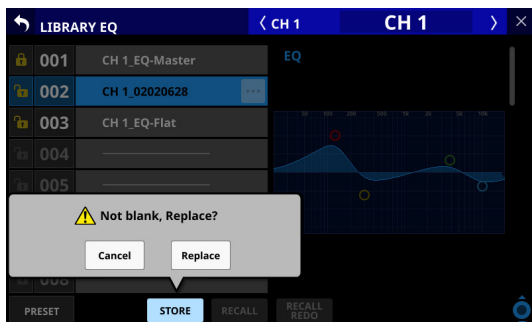

- Tap the Cancel button to cancel storing in the library and close the confirmation message.
- Tap the Replace button to overwrite the library settings data with the same name and close the confirmation message.

⑨ RECALL button

- On LIBRARY MODULE Screens, after selecting the data slot, tap this button to open a window to confirm the data to be recalled.

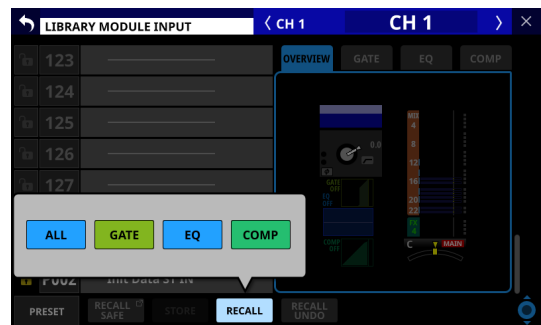

Tap the button for the desired recall data to open a recall confirmation window.

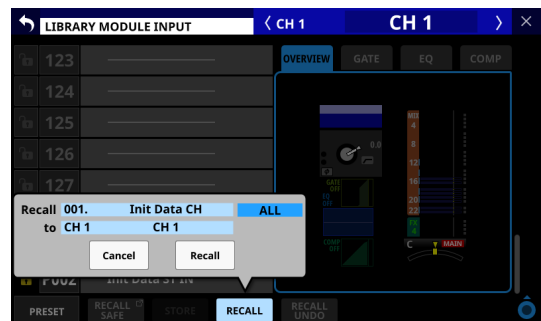

- Tap the Cancel button in the recall confirmation window to cancel recalling from the library and close the confirmation message.
- Tap the Recall button in the recall confirmation window to recall the library settings data for the selected recall items to the currently selected module and return to the MODULE Screen.
- On GATE/EXP/DE-ESSER, EQ, COMP/DUCKER, FX and GEQ library screens, after selecting the data slot, tap this button to open a recall confirmation window.

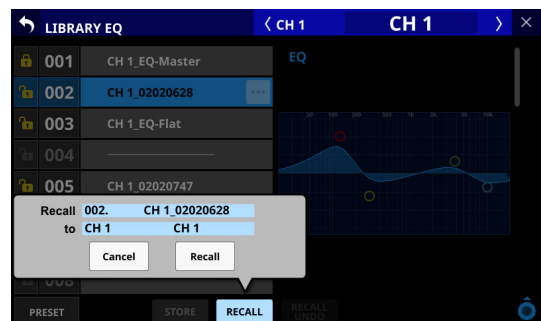

- Tap the Cancel button to cancel recalling from the library and close the confirmation message.
- Tap the Recall button to recall the library settings data to the currently selected module and return to the MODULE Screen.
- If no data slot is selected or a data slot that does not have saved data is selected, this button will appear gray.

8 – Saving and recalling setting data

⑩ RECALL UNDO/REDO button

Tap this button to undo the last executed recall operation for that library or to redo that operation.

Undo and redo are only possible with the module that was last used for recall with that library. If a different module is selected or recall has not been conducted since startup, the Undo button will appear gray.

⑪ Scroll knob and scrollbar

Drag the scrollbar to scroll the screen. The LIBRARY List can also be scrolled by swiping up and down as well as by turning LCD knob 8.

MODULE RECALL SAFE screens

Use the following MODULE RECALL SAFE screens to select parameters that will be protected (settings retained) when module libraries are recalled.

- MODULE INPUT RECALL SAFE screen

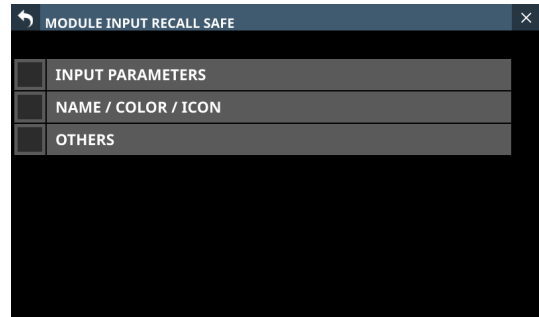

- MODULE FX RTN RECALL SAFE screen

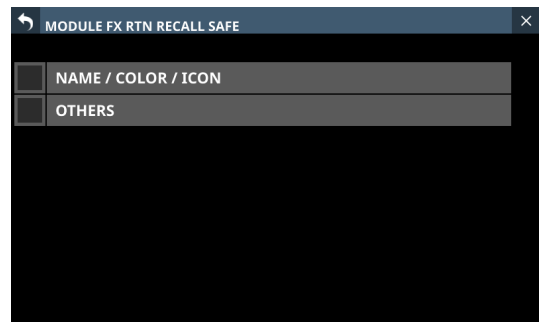

- MODULE OUTPUT RECALL SAFE screen

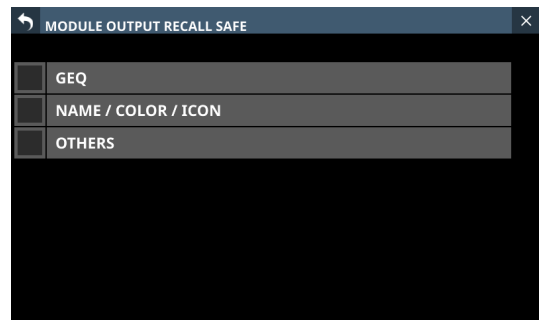

Tap the RECALL SAFE buttons on the corresponding module library screens to open these screens.

NOTE

- Settings included in INPUT PARAMETERS on the MODULE INPUT RECALL SAFE Screen
 - Analog Gain
 - Analog Gain GANG On/Off
 - Phantom On/Off
 - PAD On/Off
 - Phase
 - D.Trim
 - HPF Freq
 - HPF On/Off
- The following parameters are not included in module libraries.
 - Routing

8 – Saving and recalling setting data

All System Data screen

On this screen, settings for the entire mixer including all snapshot and library data (“All System Data”) can be handled in the following ways.

- All System Data can be saved as a file to the internal storage
- All System Data can be recalled from the internal storage (and applied to the mixer)
- All System Data can be backed up (exported as a file) to an SD card or USB flash drive
- All System Data can be restored (imported as a file) from an SD card or USB flash drive to the internal storage

NOTE

The Password setting on the Network Setup Screen is excluded when backing up and restoring All System Data.

Tap Menu Screen > System Setup menu > All System Data to open this screen.

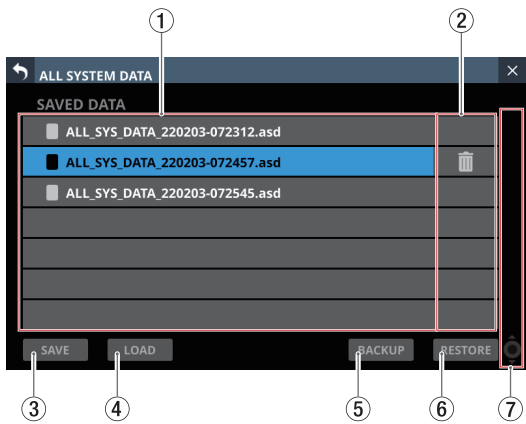

① List of saved files

This list shows All System Data Files that have been saved in the internal storage.

The selected file is highlighted.

② button

- This button only appears for the selected file.
- Tap this button to open a confirmation message for deleting the All System Data file.

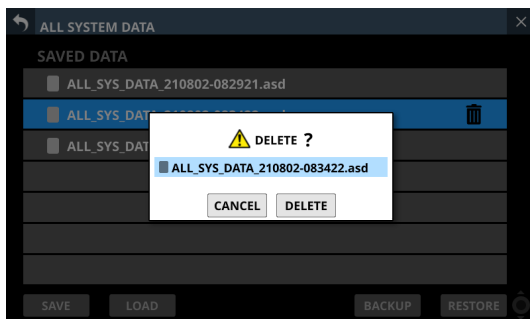

- Tap the CANCEL button to close the confirmation message.
- Tapping the DELETE button will delete the selected All System Data file from the internal storage and close the confirmation message. The selected All System Data file will be removed from the list of saved files (①).

③ SAVE button

Tap this button to save All System Data to the internal storage. (See “Saving All System Data” on page 187.)

④ LOAD button

- Tap this button to load All System Data from the internal storage. (See “Loading All System Data” on page 187.)
- If no All System Data file is selected, this button will appear gray.

⑤ BACKUP button

- If no All System Data file is selected, this button will appear gray.
- Tap this button when an All System Data file is selected to open a confirmation message for backing up that data to external memory. (See “Backing up All System Data” on page 188.)

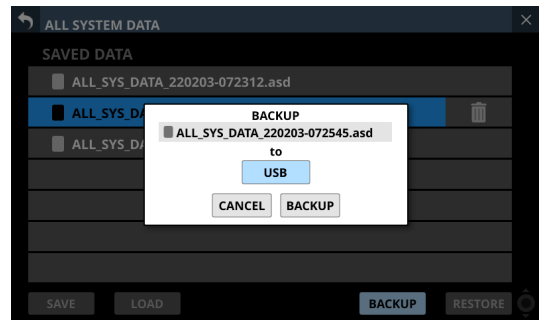

⑥ RESTORE button

Tap this button to open the ALL SYSTEM DATA RESTORE Screen. (See “Restoring All System Data” on page 189.)

⑦ Scroll knob and scrollbar

- If all the saved files cannot all be shown on the screen at once, the scrollbar will appear and the scroll knob will be highlighted.
- Drag the scrollbar to scroll the screen. The list of saved files (①) can also be scrolled by swiping up and down as well as by turning LCD knob 8.

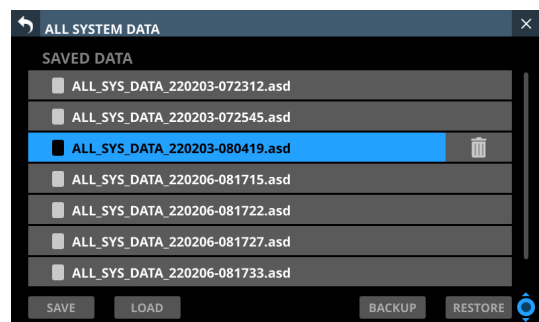

8 – Saving and recalling setting data

Saving All System Data

Follow the procedures below to save All System Data to the internal storage.

1. Tap the SAVE (③) button to open a confirmation message for saving All System Data.

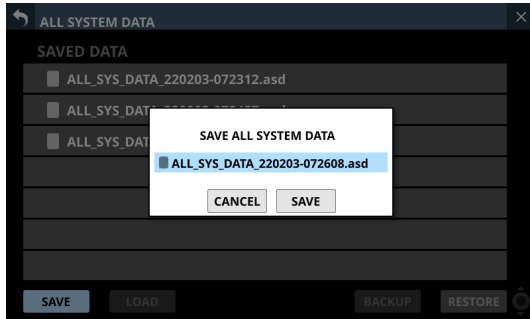

2. Tapping the CANCEL button on the confirmation message will close the message.
Tapping the SAVE button on the confirmation message will save All System Data to the internal storage and close the confirmation message.
The name shown on the confirmation message will be added to the list of saved files (①).

Loading All System Data

Follow the procedures below to load All System Data from the internal storage (applying it to the mixer).

1. Tap the LOAD button (④) when an All System Data file is selected to open a confirmation message to load that data.

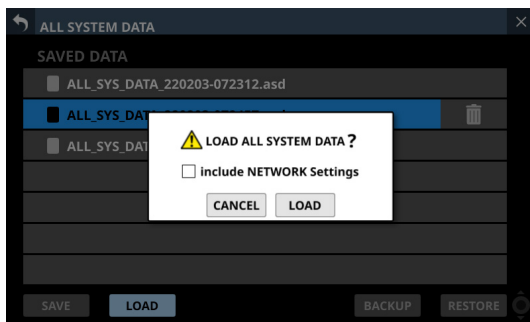

NOTE

To load network settings, tap the "include NETWORK Settings" check box on the confirmation message to add a check (✓) to it.

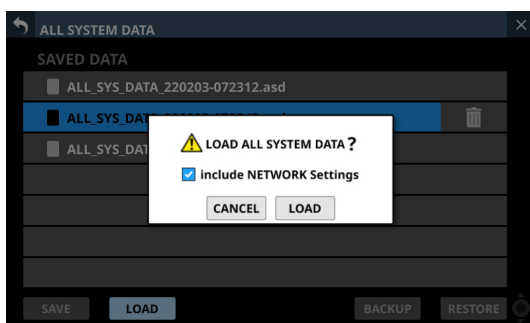

2. Tapping the CANCEL button on the confirmation message will close the message.
Tapping the LOAD button on the confirmation message will start loading the selected All System Data from the internal storage and close the confirmation message. The message shown below will appear while loading. After loading completes, the file will no longer be selected.

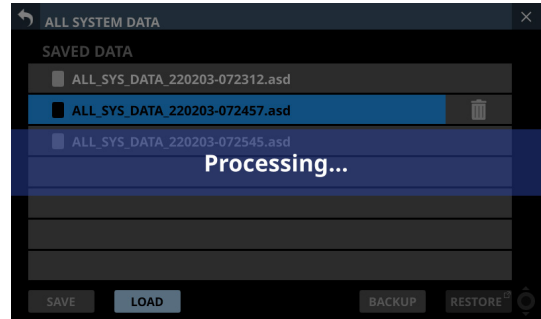

ATTENTION

- Use caution, because loading All System Data will replace all Snapshot and LIBRARY settings data with the loaded data. To keep the current data, save it before loading.
- All System Data cannot be loaded with an IF-MTR32 that is currently recording or playing. Stop IF-MTR32 recording/playback before loading.

8 – Saving and recalling setting data

Backing up All System Data

All System Data in the internal storage can be backed up (exported as a file) to an SD card or USB flash drive.

1. Connect the media to use for backup.
2. Tap the file to be backed up to select it.

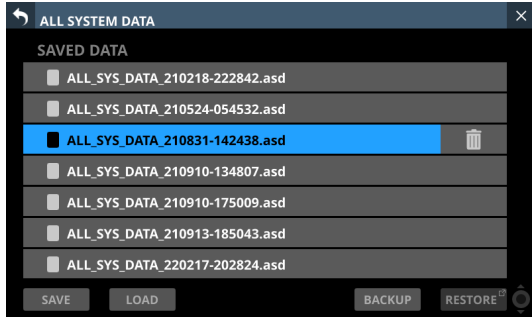

3. Tap the BACKUP button. A confirmation message will appear.

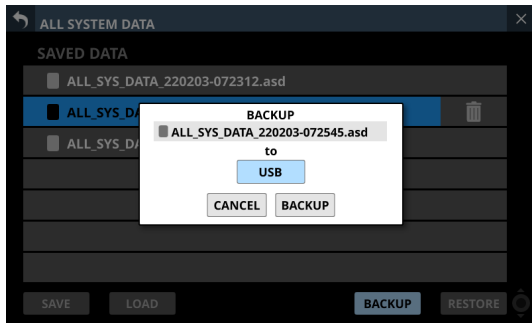

- If both an SD card and a USB flash drive are connected, tap the media selection button shown with a ► and select the media to use for the backup.

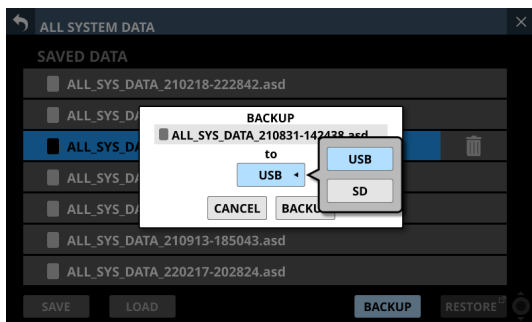
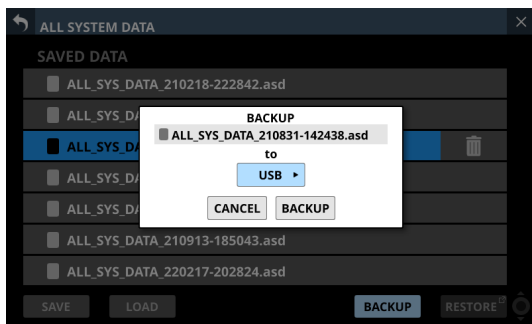

4. Tapping the BACKUP button on the confirmation message will back up the All System Data file. The backup data will be saved in the following fixed folder on the media used for backup.

\\TASCAM\SONICVIEW\ALL_SYSTEM_DATA

- If that folder does not exist on the backup media, it will be created.
- A confirmation message will be shown if a file with the same name already exists on the backup media.

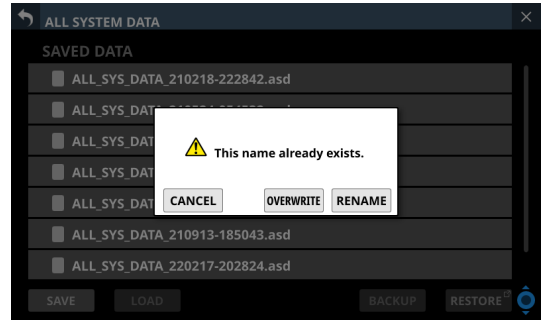

- Tap the CANCEL button to close the confirmation message.
- Tap the OVERWRITE button to overwrite the All System Data file with the same name and close the confirmation message.
- Tap the RENAME button to open the RENAME Screen. Input a name that is not the same as an existing All System Data file name. Then, tap the Enter button to execute the backup and return to the ALL SYSTEM DATA Screen.
- The following message will be shown if the backup destination media is a locked SD card.

Cannot Backup. SD card Locked.

- One of the following messages will be shown if the backup destination media does not have enough open space.

Cannot Backup. SD card is full.

Cannot Backup. USB memory is full.

- Tap the CANCEL button to close the confirmation message.
- Tapping the BACKUP button will back up (export) the All System Data file from the internal storage to the selected external media and close the confirmation message.

8 – Saving and recalling setting data

Restoring All System Data

All System Data that is backed up on an SD card or USB flash drive can be imported to the internal storage.

ATTENTION

If a Snapshot created on a unit with firmware version 1.1.0 or later is recalled by a unit with firmware version 1.0.x, proper operation will not be possible, so the following restriction applies.

- All System Data created on units with firmware version 1.1.0 or later cannot be restored on units with firmware version 1.0.x. (All System Data created by units with firmware version 1.0.x can be restored on units with firmware version 1.1.0 or later.)

NOTE

Restoring imports the All System Data on an external storage device as a file to the internal storage.

This does not affect the mixer settings.

To apply imported All System Data settings to the mixer settings, load the All System Data file. (See “Loading All System Data” on page 187.)

1. Connect the media that has the All System Data file to be restored written to it.
2. Tap the RESTORE button.
The ALL SYSTEM DATA RESTORE Screen will open.

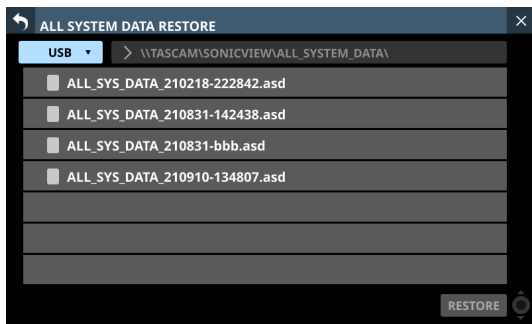

NOTE

If no SD or USB flash drive is connected, the following pop-up message will appear.

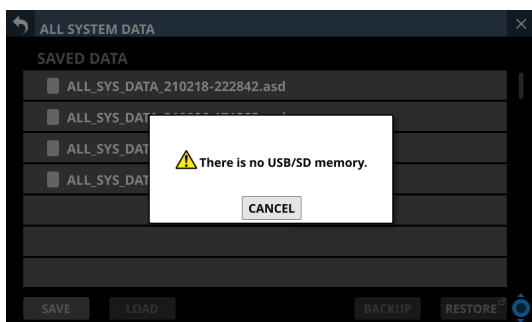

3. Tap the media selection button to select the media that has the All System Data file to be restored.

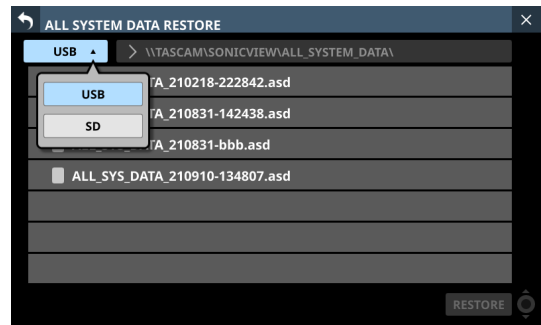

NOTE

If either an SD card or a USB flash drive is connected, but not both, the media selection menu will not be shown.

4. If the file you want to restore is not in the shown folder, tap the folder selection button to the right of the media selection button to open the folder selection pull-down menu.
 - If the entire pull-down menu cannot be shown on the display, use LCD knob 8, the scrollbar or swipe gestures to scroll the screen.
 - Tap “>” to the left of a folder name to open that folder and show its contents.
 - Tap “√” to the left of the name of a folder to close it.
 - Tap the name of a folder to select it.
 - The name of the selected folder is reflected in the folder selection button path display field.

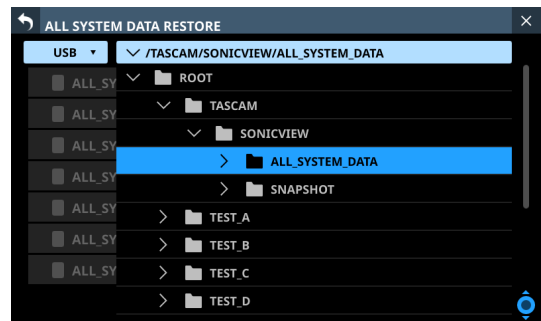

Folder selection pull-down menu example

5. After selecting the desired folder, tap the “√” at the left the end of the folder selection button to close the folder selection pull-down menu.

8 – Saving and recalling setting data

6. Select the file to restore, and tap the RESTORE button.
A confirmation message will appear.

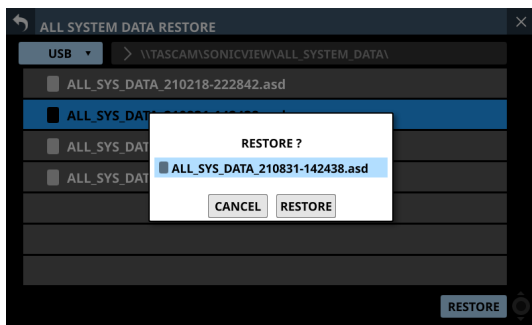

7. Tapping the RESTORE button on the confirmation message will restore the file.
 - A confirmation message will be shown if a file with the same name already exists on the restore destination (internal storage).

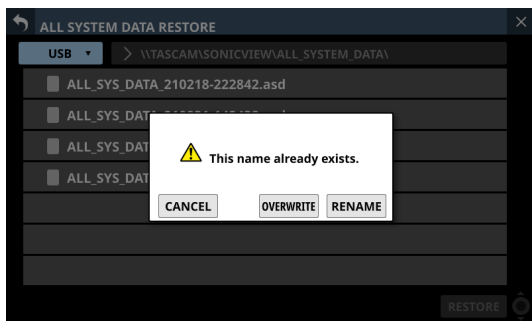

- Tap the CANCEL button to close the confirmation message.
- Tap the OVERWRITE button to overwrite the All System Data file with the same name and close the confirmation message.
- Tap the RENAME button to open the RENAME Screen. Input a name that is not the same as an existing All System Data name. Then, tap the Enter button to restore the data and return to the ALL SYSTEM DATA Screen.
- One of the following messages will be shown if the internal storage does not have enough open space.

Cannot Restore. Internal memory is full.

9 – Various information displays

INFORMATION Screen

This screen shows information about the entire system and errors.

Tap Menu Screen > System Setup > Info to open this screen.

When this screen is opened, the last open page will be shown again if the unit is functioning properly.

The ERROR page will open if an error or alert is occurring with the unit.

STATUS page

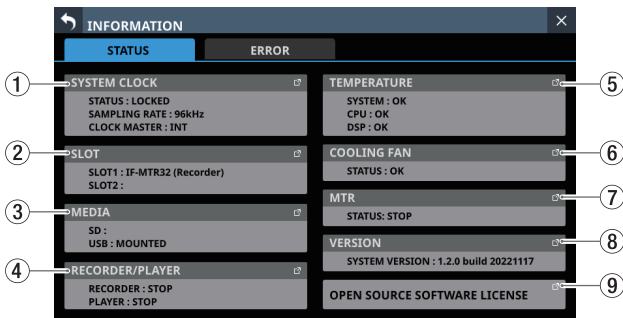

① SYSTEM CLOCK

- This show the system clock status along with the sampling frequency and master clock currently used for operation.
- Tap this area to open the SYNC CLOCK Screen. (See “SYNC CLOCK screen” on page 34.)

② SLOT

- This shows the names of the expansion cards installed in SLOT 1 and SLOT 2.
- Tap this area to open the SLOT SETUP Screen. (See “SLOT SETUP screen” on page 92.)
- These fields will be empty when nothing is installed.

③ MEDIA

- This shows the USB flash drive and SD card states.
- Tap this area to open the MEDIA MANAGE Screen. (See “Media Manage Screen” on page 200.)

④ RECORDER/PLAYER

- This shows the operation status of the internal recorder/ player.
- Tap this area to open the RECORDER/PLAYER Screen. (See “RECORDER/PLAYER Screen” on page 204.)

⑤ TEMPERATURE

- These show the temperature states of the system, CPU and DSP.
- Tap this area to open the PREFERENCES Screen. (See “PREFERENCES screen” on page 36.)

⑥ COOLING FAN

- This shows the operation status of the internal cooling fan.
- Tap this area to open the PREFERENCES Screen. (See “PREFERENCES screen” on page 36.)

⑦ MTR

- This shows the operational status of the IF-MTR32 (multitrack recorder) card installed in SLOT 1 or SLOT 2 on the rear panel.
- Tap this area when an IF-MTR32 (multitrack recorder) card is installed to open the MULTI TRACK RECORDER Screen. (See “MULTI TRACK RECORDER Screen” on page 217.)

⑧ VERSION

- This shows information about the system firmware version.
- Tap this area to open the Version Information Screen. (See “Version Information Screen” on page 201.)

⑨ OPEN SOURCE SOFTWARE LICENSE

- This shows open source software licenses.
- Tap this area to open the OPEN SOURCE SOFTWARE LICENSE Screen. (See “OPEN SOURCE SOFTWARE LICENSE Screen” on page 195.)

ERROR page

When errors and alerts occur (“Sonicview 16/24 Error Screen SYSTEM error/alert message list” on page 196), they are listed on this page.

The content of this page is cleared when the unit is turned off.

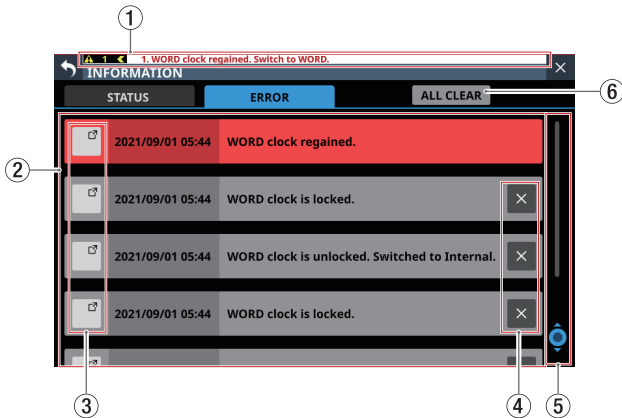

① Error/alert information area

When an error or alert occurs, a message will be shown at top of every touchscreen. (See “Error/alert message display” on page 194.)

② Error/alert list

- When errors/alerts occur, details about them are shown.
Date and time: YYYY/MM/DD HH:MM
- New errors/alerts are shown in the order that they occur from the top.
- Background colors differ according to the error status.

| Error status | Background color |
|---------------------------|------------------|
| Error currently occurring | Red |
| Alert currently occurring | Yellow |
| Resolved error | Gray |

- When an error is resolved its background color becomes gray. This includes device temperature errors and other errors that are resolved automatically as well as system clock errors and other errors that are resolved manually.

③ buttons

Tap these buttons to open setting screens related to each error/alert.

④ buttons

Tap buttons on error/alert to clear them from the list.

NOTE

This button does not appear for errors that are currently occurring, which cannot be cleared from the list.

⑤ Scroll knob and scrollbar

These appear when all errors/alerts cannot be shown on the display at the same time.

Drag the scrollbar to scroll the screen. Errors can also be scrolled by swiping up and down as well as by turning LCD knob 8.

⑥ ALL CLEAR button

Tap this button to open a confirmation message for clearing all error and alert history.

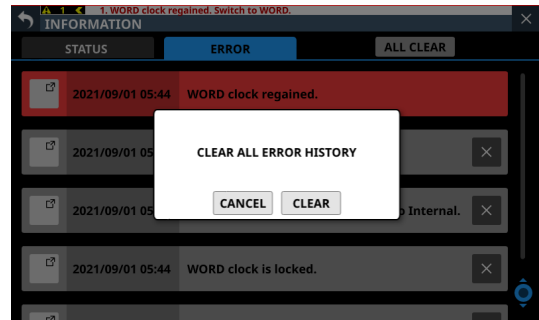

Tapping the CLEAR button will clear all error and alert history.

NOTE

Errors that are currently occurring will not be cleared from the error list.

9 – Various information displays

Error/alert message display

- When an error or alert occurs, a message will be shown at top of every touchscreen (“Sonicview 16/24 Error Screen SYSTEM error/alert message list” on page 196).

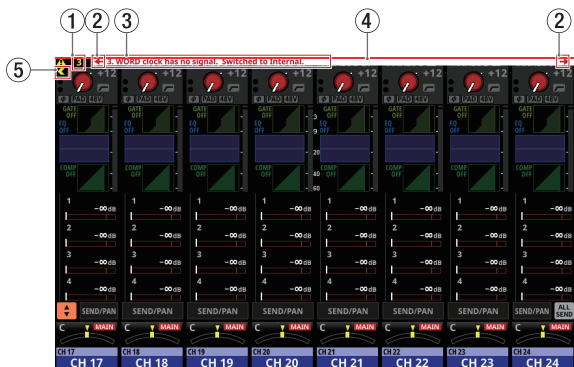

Error/alert messages open on the Home Screen



Error/alert messages closed on the Home Screen

① Number of errors/alerts

This shows the number of errors and alerts that are currently occurring.

② Error/alert message switching buttons

- These are shown when multiple errors/alerts are occurring.
- Tap these buttons to change the content shown in the error/alert message display area (③) to a different message.

③ Error/alert message display area

- This shows the content of an error/alert that is currently occurring. The number at the beginning of the message shows the order that it occurred.
- Tap this area to open the screen that corresponds to the content of the error/alert.

④ Blinking error bar

Until errors and alerts are resolved, a blinking red line will be shown at top of every touchscreen.

⑤ Close button

If the error/alert message display area (③) hides part of the display and makes operation impossible, this button can be tapped to close it.

NOTE

If a new error/alert occurs when the error/alert message display area (③) is closed, it will reopen automatically.

⑥ Open button

Tap this button to reopen the error/alert message display area (③) if it has been closed.

- When an alert occurs, a message window like the following will appear on the right touchscreen (“Sonicview 16/24 Error Screen SYSTEM error/alert message list” on page 196).

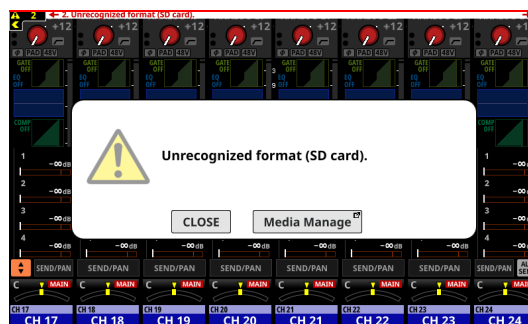

- Tap the CLOSE button to close the message.
- Tap the screen name button to open the screen that corresponds to the content of the alert on the right touchscreen.

OPEN SOURCE SOFTWARE LICENSE Screen

This screen shows information about licenses for open source software used by this unit.

Tap OPEN SOURCE SOFTWARE LICENSE on the INFORMATION Screen to open this screen.

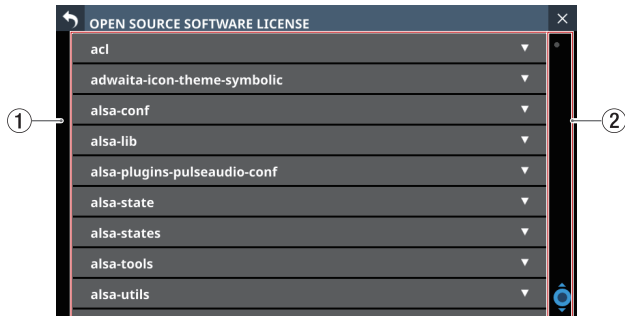

① License information list

- This is a list of licenses for open source software used by this unit.
- Tap the ▼ icon to show the license document for that open source software.

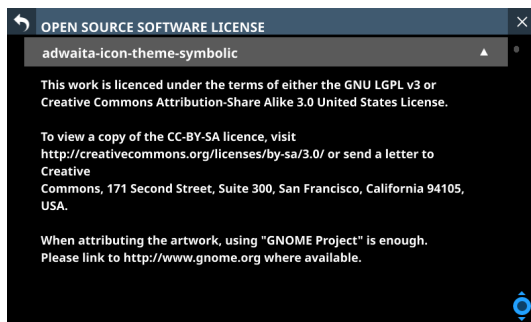

- When a license document is open, tap the ▲ icon to close it.

② Scrollbar display

This appears when the entire license document cannot be shown on the display at the same time.

Drag the display to scroll the screen. The list can also be scrolled by swiping up and down as well as by turning LCD knob 8.

9 – Various information displays

Sonicview 16/24 Error Screen SYSTEM error/alert message list

| Error/alert type | Message | Meaning | Note |
|--------------------------|--|---|--|
| System Clock Error | "Master clock name" clock has no signal. Switched to Internal. | There is no signal from the master clock. | Master clock name: WORD Dante SLOT 1 (slot signal type) SLOT 2 (slot signal type) Slot signal types: AES, Dante, MADI |
| | "Master clock name" clock is unlocked. Switched to Internal. | The master clock is unlocked. | |
| | "Master clock name" clock regained. | The master clock has been regained (locking is possible again after becoming unlocked). | |
| | "Master clock name" clock regained. Can be re-synced to "Master clock name". | The master clock has been regained (locking is possible again after becoming unlocked). (message that appears at the top of the screen) | |
| | "Master clock name" clock is locked. | The master clock is locked. (This is shown in gray on the INFORMATION Screen ERROR page as a record of when locked status was restored after a No Signal or Unlock state error was resolved. This is not shown at the top of the screen.) | |
| Slot Card Error | SLOT [slot number] [card name] was removed. | The expansion card was removed. | Slot number: 1/2 Card name: • IF-AE16 (AES) • IF-AN16/OUT (Analog Out) • IF-DA64 (Dante) • IF-MA64/BN (MADI) • IF-MA64/EX (MADI) |
| | SLOT [slot number] [card name] failure. | Trouble was detected with the expansion card. | |
| Internal Dante Error | Dante Module Unavailable. | The built-in Dante module is in an unusable state (in safe mode/ updating). | This is shown in gray on the INFORMATION Screen ERROR page as an error record. This is not shown at the top of the screen. |
| | Dante Module Available. | The built-in Dante module is in a usable state. | |
| Device Temperature Error | SYSTEM is too HOT. Increase FAN speed. | The internal temperature of the unit has risen. Increase the speed of the cooling fan. | This is shown in gray on the INFORMATION Screen ERROR page as an error record. This is not shown at the top of the screen. |
| | CPU is too HOT. Increase FAN speed. | The temperature of the CPU has risen. Increase the speed of the cooling fan. | |
| | DSP is too HOT. Increase FAN speed. | The temperature of the DSP has risen. Increase the speed of the cooling fan. | |
| | SYSTEM is too COLD. | The internal temperature of the unit is too low. | |
| | CPU is too COLD. | The temperature of the CPU is too low. | |
| | DSP is too COLD. | The temperature of the DSP is too low. | |
| | SYSTEM temperature normal. | The internal temperature of the unit has returned to the proper range. | |
| | CPU temperature normal. | The temperature of the CPU has returned to the proper range. | |
| DSP temperature normal. | The temperature of the DSP has returned to the proper range. | | |

9 – Various information displays

| Error/alert type | Message | Meaning | Note |
|--------------------------|---|--|--|
| Cooling FAN Error | Cooling FAN failure. | The cooling fan has stopped. | |
| | Cooling FAN in motion. | The cooling fan has started moving. | This is shown in gray on the INFORMATION Screen ERROR page as an error record. This is not shown at the top of the screen. |
| Prohibited Setting Alert | Clock master changed to Internal. IF-AE16 cannot be clock master. | Even though an IF-AE16 cannot be selected as the master clock, it was, so the master clock was changed to "INT". | This could occur upon startup if the SLOT card set as the master clock was switched to an IF-AE16 or IF-AN16/OUT when the power was off. |
| | Clock master changed to Internal. IF-AN16/OUT cannot be clock master. | Even though an IF-AN16/OUT cannot be selected as the master clock, it was, so the master clock was changed to "INT". | |
| Slot Card Alert | SLOT [slot number] [card name] installed. | An expansion card was installed while the power was off. | Slot number: 1/2 Card name: <ul style="list-style-type: none"> • IF-AE16 (AES) • IF-AN16/OUT (Analog Out) • IF-DA64 (Dante) • IF-MA64/BN (MADI) • IF-MA64/EX (MADI) |
| | SLOT [slot number] was changed from [old card name] to [current card name]. | The expansion card was changed while the power was off. | |
| Internal Dante Alert | Dante I/O Sample rate changed by Dante Controller. | The internal Dante input/output sampling frequency was changed by Dante Controller. | |
| Storage Media Alert | Unrecognized format (SD card). | An SD card with a format that cannot be recognized was loaded. | |
| | Unrecognized format (USB memory). | A USB flash drive with a format that cannot be recognized was loaded. | |
| Record Alert | Recording stopped. Media Full. | The medium did not have enough capacity, so recording stopped. | |
| | Recording error. Buffer overflow. | Recording stopped because a buffer overflow occurred during recording. | |
| | Recording stopped. File limit reached. Please change to another folder. | Recording stopped because the total number of files in the folder would exceed the system limit. Switch to another folder. | |
| | Recording error. SD card was removed. | Recording stopped because the SD card was disconnected during recording. | |
| Play Alert | Play error. Buffer underrun. | Playback stopped because a buffer underrun occurred during playback. | |
| | Play error. [Media name] was removed. | Playback stopped because the media was disconnected during playback. | Media name: SD card USB |
| SB-16D mounting error | SB-16D ID #xx-xx has been disconnected. | A mounted SB-16D has been disconnected from the Dante network and became virtually mounted. | xx = 1 – 16 |
| SB-16D mounting alert | SB-16D ID#xx-xx connected. | A virtually mounted SB-16D has been connected to the Dante network and became mounted. | xx = 1 – 16 This message will not be shown if this alert occurs within three minutes of starting up. |

9 – Various information displays

| Error/alert type | Message | Meaning | Note |
|--|---|--|--|
| SB-16D duplicate ID error | SB-16D ID #xx-xx has a ID conflict. | An SB-16D with the same ID as an already mounted SB-16D has been connected to the Dante network. | xx = 1 – 16 |
| | SB-16D ID #xx-xx conflict has been resolved. | The duplicated ID conflict of mounted SB-16D units has been resolved. | xx = 1 – 16 This is shown in gray on the INFORMATION Screen ERROR page as an error record. This is not shown at the top of the screen. |
| IF-MTR32 (multitrack recorder) alert | MTR File Error. | Reading the file failed with the MTR. | |
| | MTR Non-Supported WAV format. | The WAV file is not supported by the MTR Please see “File format overview” on page 230 for file formats that can be used by the MTR. | |
| | MTR Cannot MARK. (Limit Reached) | Only 99 marks can be added. | |
| | MTR No Playback File. | No file is available for playback with the MTR. | |
| | MTR Playing Error. | MTR playback failed. Check the file. | |
| | MTR cannot record. Please enable at least one REC READY track | Recording cannot start because no MTR recording track has been selected. Enable REC READY for at least one. | |
| | MTR buffer overflow occurred. Recording will continue. | Writing to the MTR SD card timed out. This has caused audio to be interrupted and noise to occur. A mark was added at the point when audio was interrupted. Execute the erase format function or change the SD card. | Executing ERASE format for the SD card on the MULTI TRACK RECORDER - MENU Screen should restore the performance of the card. However, writing speed might not be restored depending on the SD card condition (including malfunction and age). |
| | MTR Recording stopped. Buffer overflow. | Recording stopped because SD card writing performance with the MTR has degraded. A mark has been added at the point when audio was interrupted because writing to the SD card timed out. Check the audio around the mark. Execute the erase format function or change the SD card. | |
| | MTR Recording stopped. SD Card Full. | Recording stopped because the MTR SD card has no open space. | |
| MTR Recording stopped. Take limit reached. Please change to another project. | MTR recording stopped because the total number of files, folders and other items inside the folder was great. | | |

9 – Various information displays

| Error/alert type | Message | Meaning | Note |
|---|--|--|------------------------|
| IF-MTR32 (multitrack recorder) alert | MTR Failed to write. | Writing failed with the MTR. Replace the SD card. | |
| | MTR File Protected. | Editing is not possible because the MTR file is protected from writing. Remove file protection. | |
| | MTR Protected SD Card. Please unprotect the SD card. | The MTR SD card is locked. Remove protection. | |
| | MTR SD Card Error. Please format the SD card. | The MTR SD card is not formatted properly or the card might be broken. Format the SD card. Formatting will erase all the data on that card. | |
| | MTR Format Error. Please format the SD card. | The MTR SD card is not formatted properly or the card might be broken. Format the SD card. Formatting will erase all the data on that card. | |
| | MTR Operation cannot be continued. Please reinsert the SD CARD. | A problem occurred with the MTR SD card. Reinsert the card. | |
| | MTR Invalid SD Card. Please change the SD card. | Something might be wrong with the MTR SD card. Replace the SD card. | |
| | MTR System ROM Error. | If this error occurs frequently, please contact TASCAM customer support | |
| | Unknown Error. XX An unexpected error occurred inside the system. Please contact our customer support with the error code. | If this error occurs frequently, please contact TASCAM customer support. | XX is the error number |

9 – Various information displays

Media Manage Screen

This screen shows media information and can be used to format media.

Tap Menu Screen > System Setup > Media Manage to open this screen.

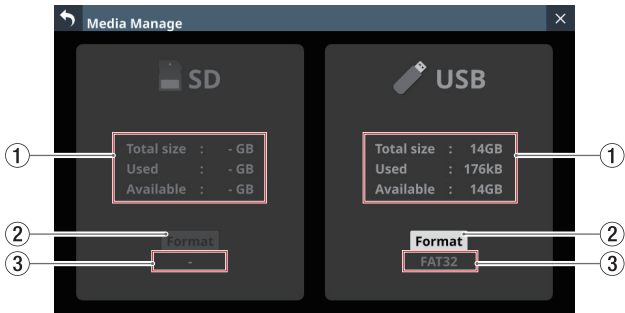

① Media information

This shows information about the loaded SD card/USB flash drive.

| Item | Explanation |
|------------|--|
| Total size | This shows the total capacity of the media. |
| Used | This shows the amount of space already used. |
| Available | This shows the amount of free space. |

② Format button

Tap this button to start formatting. (See “Formatting media” on page 200.)

NOTE

If a write-protected SD card is loaded, “LOCKED” will be shown above the Format button, which will be shown in gray, and formatting will not be possible.

③ Format name

This shows the name of the format (file system name) used by the loaded SD card/USB flash drive.

NOTE

If a medium has not been loaded, this will appear gray.

Formatting media

ATTENTION

- If an SD card is write-protected, it cannot be formatted. Disable write-protection. (See “SD card write protection switches” on page 33.)
- Formatting erases all the data on the SD card or USB flash drive. Confirm that this is okay before proceeding.
- Always use this unit to format medias to be used with it. Operation of this unit might be affected when using an SD card or USB flash drive that has been formatted by a computer or other device.

1. Tap the Format button.
 - When formatting an SD card, a window confirming execution of formatting will open.

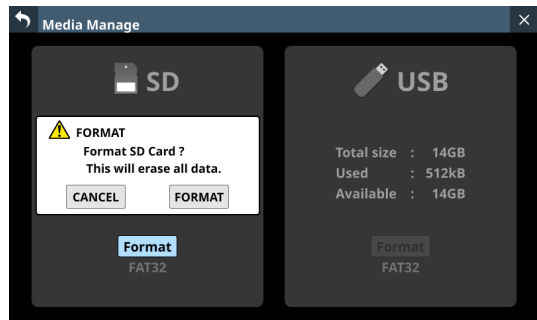

- When formatting a USB flash drive, a window for selecting the file system to use for formatting will open.

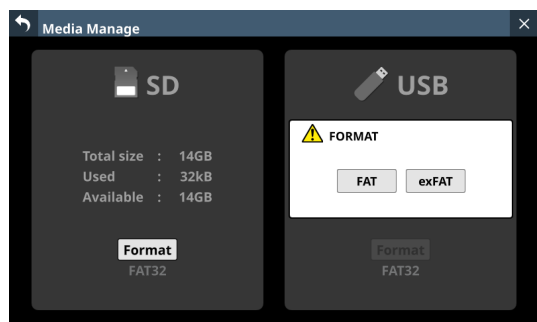

Tap the button for the file system to use for formatting.

NOTE

When formatting an SD card, the file system used for formatting will be selected automatically according to the capacity of the loaded SD card (FAT32 for SDHC cards and exFAT for SDXC cards).

2. Tap the Format button to start formatting. The following screen will appear during formatting.

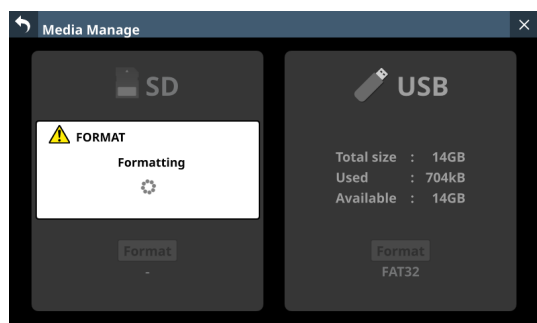

This window will close when formatting completes.

9 – Various information displays

Version Information Screen

On this screen, information is shown about the system firmware versions and build numbers, as well as cards installed in SLOT 1 and SLOT 2.

Tap Menu Screen > System Setup > Version Information to open the Version Information Screen.

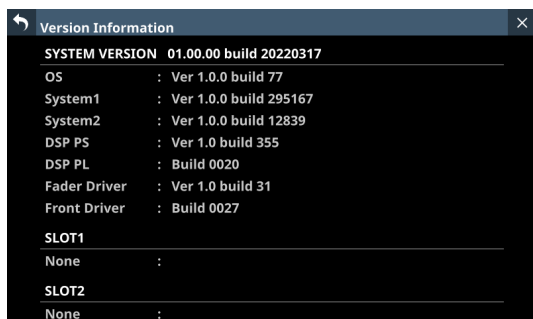

Firmware update procedures

ATTENTION

If a snapshot created on a unit with MAIN firmware version 1.1.0 or later is recalled by a unit with firmware version 1.0.x, proper operation will not be possible, so the following restrictions apply.

- Downgrading the MAIN firmware to version 1.0.x is not possible.
- Snapshot/All System Data created on units with MAIN firmware version 1.1.0 or later cannot be imported/restored on units with firmware version 1.0.x. (Snapshot/All System Data created by units with firmware version 1.0.x can be imported/restored on units with firmware version 1.1.0 or later.)

1. Download the latest firmware from the TEAC Global Site (<https://teac-global.com/>). Decompress the downloaded file if it is in ZIP format or another compressed file type.
2. Copy the downloaded firmware to the root directory (top level) of a USB flash drive.
3. Insert the USB flash drive prepared in step 2 into the USB port on the top panel.
4. Tap Menu Screen > System Setup > Firmware Update to open the Firmware Update Screen.

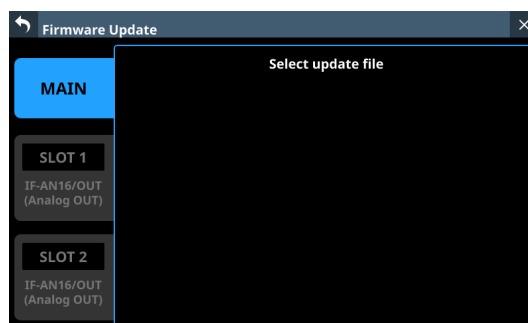

5. Tap the tab for the device to be updated.

| Device | Explanation |
|--------|--|
| MAIN | Update the firmware of the main unit. |
| SLOT 1 | Update the firmware of the expansion card installed in SLOT 1. |
| SLOT 2 | Update the firmware of the expansion card installed in SLOT 2. |

NOTE

Tabs will not be shown for slots that do not have an expansion card installed.

9 – Various information displays

6. When the USB flash drive and firmware update file have been verified, the following screen will appear.

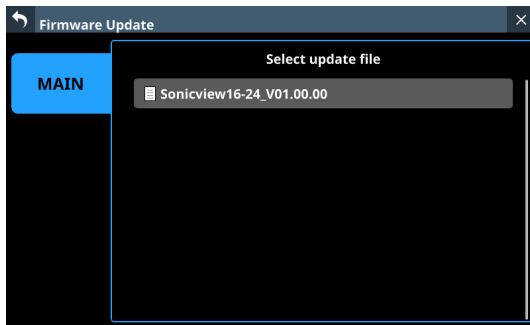

NOTE

- The screen above shows a list of firmware update files in the root folder of the USB flash drive connected to the USB2.0 port on the front of the unit. The firmware copied in step 2 above should also be shown.
 - A maximum of five lines of firmware can be shown at the same time. If there are more files than can be shown on the display at once, swipe the list up or down to scroll it.
 - The screen shown above is an example. The actual appearance will differ.
7. Tap the firmware to use for the update to select it. This will automatically prepare the firmware updater and the screen shown below will appear.

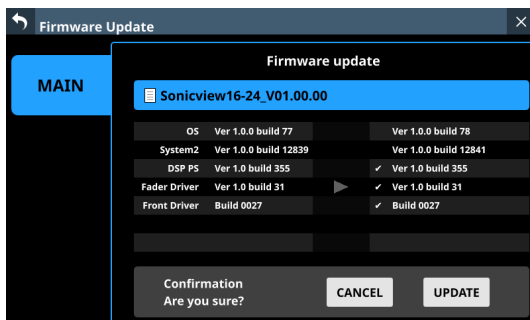

The number of the current version is shown on the left and the update version is shown on the right.

NOTE

The screen shown above is an example. The actual appearance will differ.

8. When an update confirmation message appears, tap the UPDATE button.

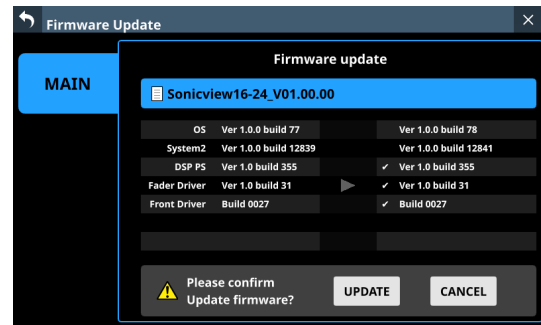

NOTE

- The UPDATE button will not be shown if updating is not necessary.
 - Tap the CANCEL button to cancel updating and return to the list of update files.
9. When an update confirmation message appears again, tap the UPDATE button. The startup screen will be shown briefly and then updating will start.

ATTENTION

- Be careful not to let the power be interrupted during the update.
 - If the power is interrupted during the update, the unit might become unstartable.
10. When the update completes, the following screen will appear.

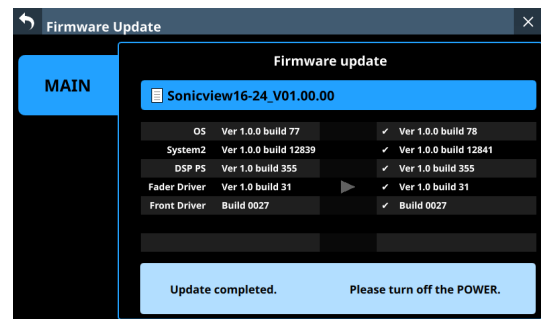

11. Use the POWER switch on the back of the unit to restart it.

ATTENTION

Even though a RESTART button is shown in MAIN firmware versions 1.0.2 and earlier, do not tap it. Always use the POWER switch on the rear panel to restart the unit.

12. After the unit restarts, confirm that the latest firmware is being used (see "Version Information Screen" on page 201).

This completes updating the unit.

13. Delete the firmware update file from the USB flash drive.

10 – Recording and playback

This unit includes a 2-track WAV recorder (SD card) and a 2-track WAV/MP3/AAC player (SD card/USB flash drive). The recording file formats are as follows.

- WAV: 48/96 kHz, 24-bit, 2-channel

Recording will be at the sampling frequency set with the Sync Clock button (②) on the SYNC CLOCK Screen. (See “Setting the sampling frequency” on page 35.)

The playback file formats are as follows.

- BWF/WAV: 48/96 kHz, 16/24-bit, 2-channel
- MP3: 44.1/48 kHz, 32–320 kbps, 2-channel
- AAC: 44.1/48 kHz, 64–320 kbps, 2-channel

RECORDER/PLAYER Screen

Control the built-in recorder/player on this screen.

Tap Menu Screen > Recorder/Player menu > Recorder/Player to open this screen.

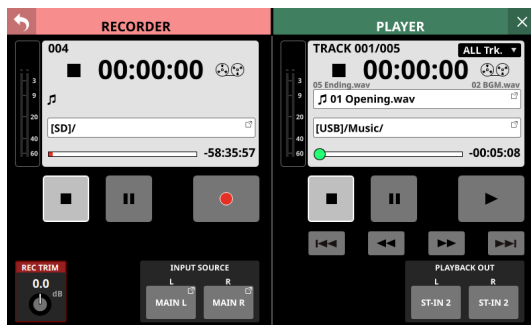

RECORDER Section

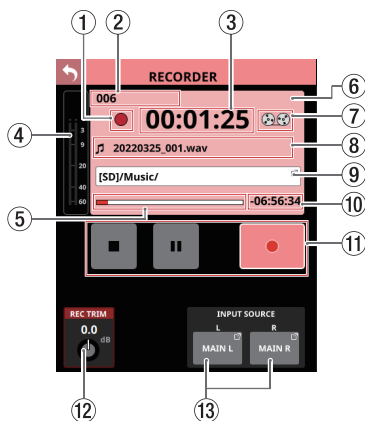

① Recorder transport status

This icon shows the transport status.

② Total number of recorded tracks

This shows the total number of recorded file tracks.

NOTE

The total number of tracks that can be recorded to one folder is 999. “Rec Limit” will be shown in the recording folder name area for folders that already have 999 tracks or that contain files with names ending “999.wav” and recording will no longer be possible.

Switch to a different folder to record.

③ Elapsed recording time

This shows the elapsed recording time.

If no media has been loaded, “--:--:--” will be shown.

④ Recording input level meters

These shows the levels input to the internal recorder.

⑤ Media capacity bar

This shows the amount of space already used as a proportion of the total space on the media.

As recording progresses, the bar extends from the left to the right.

⑥ RECORDER information area

When recording, the background of this area becomes light red to show clearly that recording is in process.

⑦ Tape reel icon

When recording, the tape reel icon turns to show clearly that the unit is operating.

⑧ Recording file name

- When recording and when recording is paused, this shows the name of the file being recorded.

- After recording is stopped, this shows the name of the file that was last recorded.

- The recording file name format is as follows.

```
YYYYMMDD_nnn.wav
YYYY: Year
MM: Month
DD: Day
nnn: 3-digit number
```

NOTE

Nothing will be shown immediately after the unit starts up, media is loaded or a folder is selected.

⑨ Recording folder name

- This shows the path of the recording destination folder.

- Tap this area to open the BROWSE screen where the recording destination folder can be selected. (See “BROWSE Screen for recording folder selection” on page 206.)

- “No Media” is shown when no SD card is loaded.

- “No free space” is shown when the SD card does not have space.

- “Unrecognized” is shown when the SD card cannot be recognized. Tap this message to open the Media Manage Screen. (See “Media Manage Screen” on page 200.)

NOTE

If the total number of files and subfolders in the folder exceeds 999, files and folders might not be shown correctly.

10 – Recording and playback

⑩ Remaining recording time

This shows the remaining available recording time of the media.

If recording is not possible because no media has been loaded or the media does not have open space, for example, “---:---:---” will be shown.

⑪ Transport operation buttons/indicators

These control the internal recorder.

| | |
|---|--|
| ■ | When recording, tap this to stop recording. When recording is stopped, this button will be highlighted white. |
| | When recording, tap this to pause recording. When recording is paused, this button will be highlighted white. |
| ● | When recording is stopped, tap this to start recording. When recording is paused, tap this to resume recording. When recording or paused, this button will be highlighted light red. |

⑫ REC TRIM knob

Turn LCD knob 1 to adjust the trim value of the level input to the recorder.

Range: -20.0 dB – +20.0 dB (in 0.1dB steps, default: 0 dB)

⑬ INPUT SOURCE setting buttons

- These show the names of the input sources. “No assign” is shown when no input source is assigned.
- Tap these buttons to open the RECORDER INPUT SOURCE SELECT Screen.

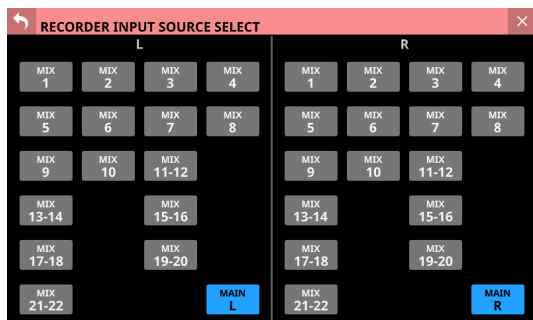

MIX 1–22 and MAIN L/R signals can be selected as inputs to the left and right channels of the recorder (default: MAIN L/R).

PLAYER Section

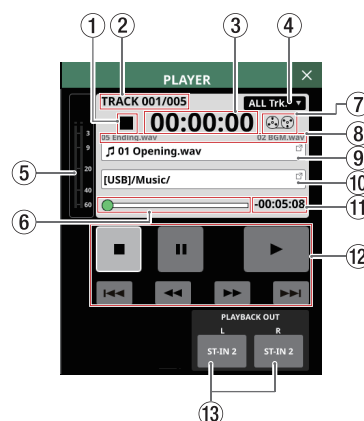

① Playback transport status

This icon shows the transport status.

② Playback track number/number of tracks

This shows the number of the currently playing track/total number of tracks.

③ Elapsed playback time

This shows the elapsed time from the beginning of the track. If no media has been loaded, “---:---:---” will be shown.

④ Playback mode

- This shows the playback mode.
- Tap this area to open a window where the playback mode can be set.



| Icon | Meaning |
|----------|---------------------------|
| 1 Trk. | Single playback |
| ALL Trk. | Folder playback (default) |
| C2B 1 | Single repeat playback |
| C2B ALL | Folder repeat playback |

Tap a button in the window to switch to that playback mode and close the window.

⑤ Playback output level meters

This shows the levels output from the player.

⑥ Time Bar

This shows the current playback position relative to the length of the take.

Drag the knob on the bar to change the playback position.

10 – Recording and playback

⑦ Tape reel icon

When playing, the tape reel icon turns to show clearly that the unit is operating.

⑧ Names of files before and after the current playback file

- The name of the file just before the current playback file is shown on the left side.
- The name of the file just after the current playback file is shown on the right side.

⑨ Name of current playback file

- This shows the name of the current playback file.
- Tap this area to open the BROWSE screen where the media, folder and file used for playback can be selected. (See "BROWSE screen for playback media, folder and file selection" on page 208.)

⑩ Playback folder name









- This shows the name of the media and the folder path used for playback.
- Tap this area to open the BROWSE screen where the media, folder and file used for playback can be selected. (See "BROWSE screen for playback media, folder and file selection" on page 208.)

⑪ Remaining playback time

This shows the remaining time of the playing track.

⑫ Transport operation buttons/indicators

These control the player.

| | |
|---|--|
|  | Tap this when the player is playing to stop playback. When the player is stopped, this button will be highlighted white. |
|  | When the player is stopped or playing, tap this button to pause playback. When the player is paused, this button will be highlighted white. |
|  | Tap this when the player is stopped or paused to start playback. When playing, this button will be highlighted green. |
|  | When playing back or in playback standby, touch this button continuously to search forward/backward while outputting sound. |
|  | Tap this when the player is stopped to skip to the previous/next file. Tap the  button when playing or paused to return to the beginning of the file. Press the  button when a file is stopped at its beginning to skip to the beginning of the previous file. Tap the  button during playback to skip to the next file. |

⑬ PLAYBACK OUT setting buttons

These show the names of the input modules to which the player outputs are assigned. "No assign" is shown when no player output is assigned. If they have been assigned to multiple input modules, they will be shown in order from the lowest number.



BROWSE Screen

BROWSE Screen for recording folder selection

Tap the recording folder name in the RECORDER Section to open the BROWSE screen where the recording destination folder can be selected.

Move to the desired existing folder or new folder to use for recording, and tap the Set REC FOLDER button ( REC FOLDER) to set that folder as the recording folder.

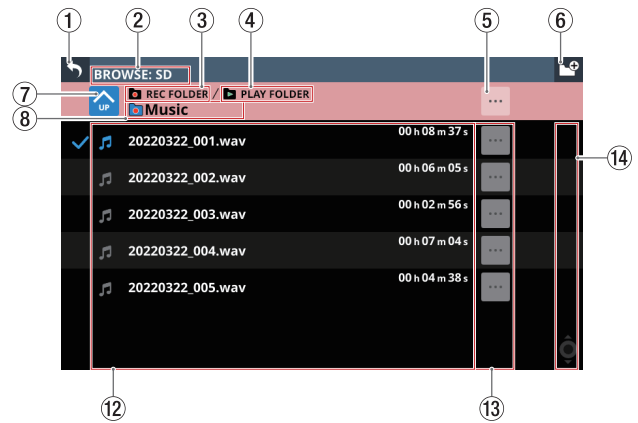

Example of folder set as the recording folder

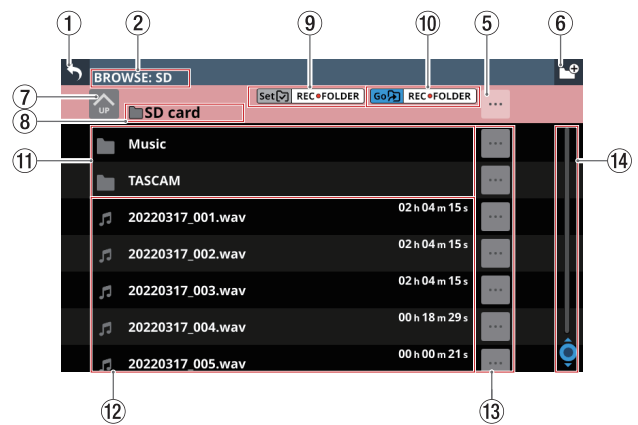

SD card root directory example

NOTE

- Recording to USB flash drives is not possible. Only SD cards can be used as recording media.
- If the total number of files and subfolders in the folder exceeds 999, files and folders might not be shown correctly.

10 – Recording and playback

① **↶ button**

Tap this button to return to the RECORDER/PLAYER Screen.

② **Media name**

This is the name of the media that is being shown.

③ **Recording folder indicator**

This indicates that the folder being shown is set as the recording folder.

④ **PLAY FOLDER indicator**

This indicates that the folder being shown is set as the playback folder.

⑤ **⋮ button**

- Tap this button to open a menu window that enables various operations at the current level.

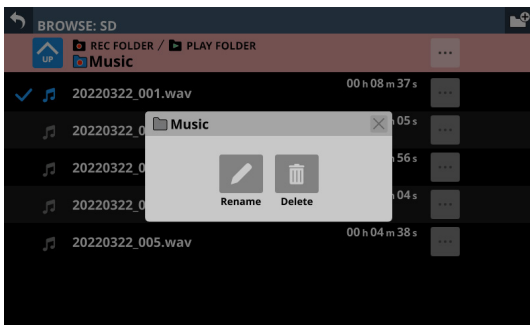

| Menu item | Explanation |
|-----------|--|
| Rename | This opens a screen where the name of the current folder can be changed. |
| Delete | This deletes the current folder. |

- This operation is not possible during recording and playback.
- Tapping this when the SD card level is open will show information about the media.

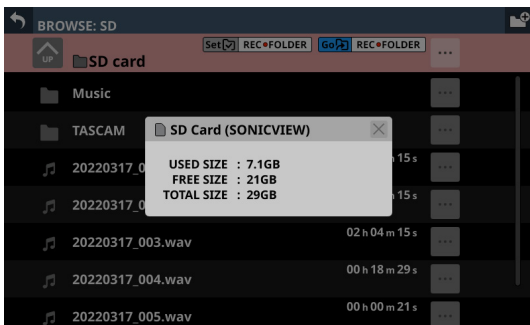

- SD card volume name
- Various SD card capacity data

⑥ **📁 button**

Use this button to create a new folder on the level being shown.

Tap this button to open a screen where the name of the folder being created can be input.



The combination of characters input can be changed depending on the status of the Caps lock and Shift keyboard buttons on the Make Folder Screen. See “Changing the keyboard keys” on page 167 for details about changing the keyboard.

⑦ **Level change button**

Tap the button to show the folder level one step above the current level.

NOTE

This will be gray when the current level is the “SD Card”, which is the top level.

⑧ **Level name**

This shows the icon and name of the level that is currently open.

⑨ **Set REC FOLDER button**

Tap this button to set the folder being shown as the recording folder. When set as the recording folder, this button and the Go REC FOLDER button (⑩) disappear and the recording folder (③) indicator appears.

For details about how to make recording folder settings, see “Setting the recording folder” on page 211.

⑩ **Go REC FOLDER button**

Tap this button to open the recording folder.

⑪ **Folder list**

- This shows the folders on the current level in name order.
- Tap this area to enter the tapped folder.

⑫ **File list**

This shows the names and lengths of playable files on the current level in name order.

10 – Recording and playback

13 Buttons

- Tap one of these buttons to show various information about the file to the left and open a menu that enables the following operations.

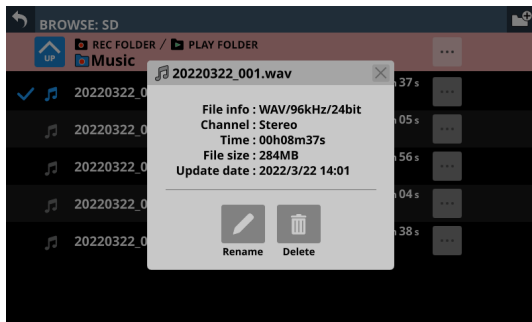

| Menu item | Explanation |
|-----------|--|
| Rename | This opens a screen where the name of the file to the left of the button can be changed. |
| Delete | This deletes the file to the left of the button. |

- This operation is not possible during recording and playback.
- Tap a button to the left of a folder to open a menu that enables the following operations on that folder.

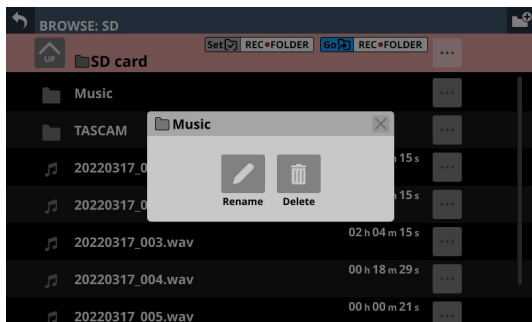

| Menu item | Explanation |
|-----------|--|
| Rename | This opens a screen where the name of the folder to the left of the button can be changed. |
| Delete | This deletes the folder to the left of the button. |

- This operation is not possible during recording and playback.

14 Scrollbar

This appears when the number of folders and files exceeds the amount that can be shown on the display at the same time. Drag the scrollbar to scroll the screen. The file list can also be scrolled by swiping it up and down as well as by turning LCD knob 8.

BROWSE screen for playback media, folder and file selection

Tap the name of the playback folder or playback file in the PLAYER section to open the BROWSE screen where the media, folder and file used for playback can be selected. Move to the folder on the media that contains the desired file for playback, and tap the Set PLAY FOLDER button (Set [] PLAY FOLDER) to set that folder on the selected media as the playback folder.

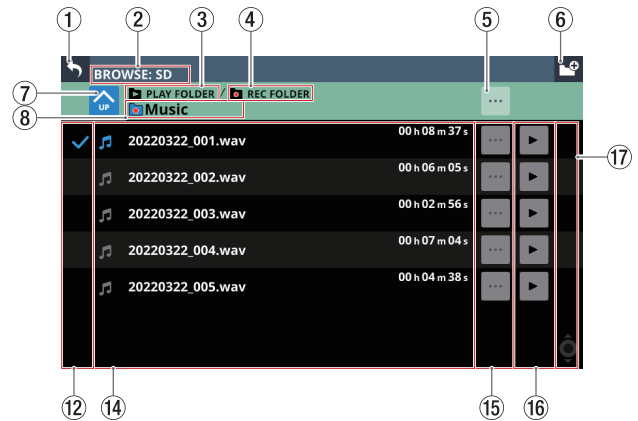

Example of folder set as the playback folder

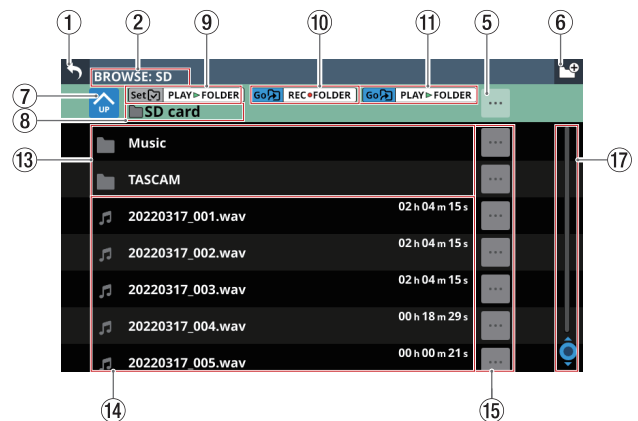

SD card root directory example

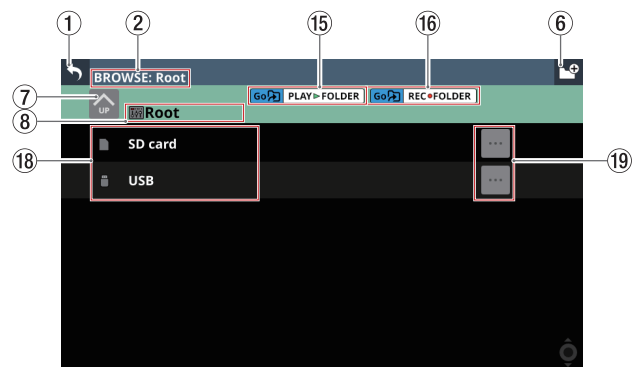

Example of mixer Root directory for selecting media

NOTE

If the total number of files and subfolders in the folder exceeds 999, files and folders might not be shown correctly.

10 – Recording and playback

① **↶ button**

Tap this button to return to the RECORDER/PLAYER Screen.

② **Media name**

This is the name of the media that is being shown.

③ **PLAY FOLDER indicator**

This indicates that the folder being shown is set as the playback folder.

④ **Recording folder indicator**

This indicates that the folder being shown is set as the recording folder.

⑤ **⋮ button**

- Tap this button to open a menu window that enables various operations at the current level.

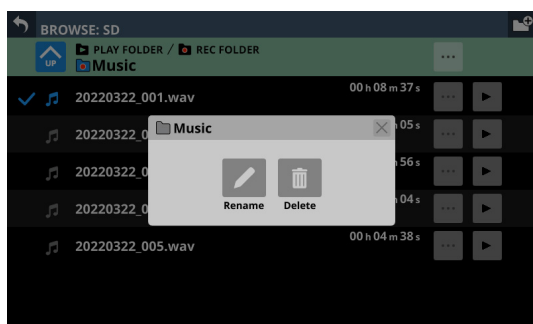

| Menu item | Explanation |
|-----------|--|
| Rename | This opens a screen where the name of the current folder can be changed. |
| Delete | This deletes the current folder. |

- This operation is not possible during recording and playback.
- Tapping this when a media root level is open will show information about the media.

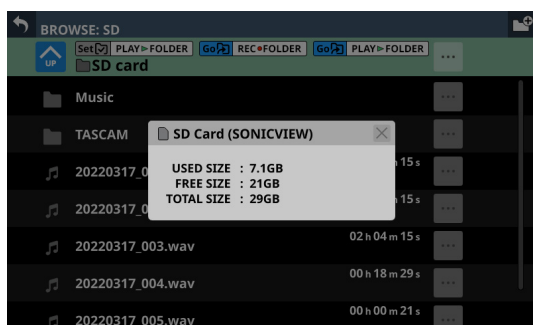

- Media volume name
- Various media capacity data

⑥ **📁 button**

Use this button to create a new folder on the level being shown.

Tap this button to open a screen where the name of the folder being created can be input.

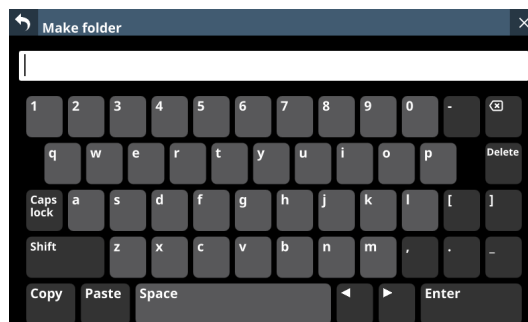

The combination of characters input can be changed depending on the status of the Caps lock and Shift keyboard buttons on the Make Folder Screen. See “Changing the keyboard keys” on page 167 for details about changing the keyboard.

⑦ **Level change button**

Tap the button to show the folder level one step above the current level.

NOTE

This will be gray when the Root (highest) level is open.

⑧ **Level name**

This shows the icon and name of the level that is currently open.

⑨ **Set PLAY FOLDER button**

Tap this button to set the folder being shown as the playback folder.

When set as the playback folder, this button and the Go PLAY FOLDER button (⑩) disappear and the PLAY FOLDER indicator (③) appears.

For details about setting the playback folder, see “Setting the playback folder” on page 211.

⑩ **Go REC FOLDER button**

Tap this button to open the recording folder.

⑪ **Go PLAY FOLDER button**

Tap this button to open the playback folder.

⑫ **Playback selection marks**

Tap this area to select audio files and make them subject to playback by adding check marks (✓).

⑬ **Folder list**

- This shows the folders on the current level in name order.
- Tap this area to enter the tapped folder.

⑭ **File list**

This shows the names and lengths of playable files on the current level in name order. Tap this area to select audio files and make them subject to playback by adding check marks (✓).

10 – Recording and playback

15 buttons

- Tap one of these buttons to show various information about the file to the left and open a menu that enables the following operations.

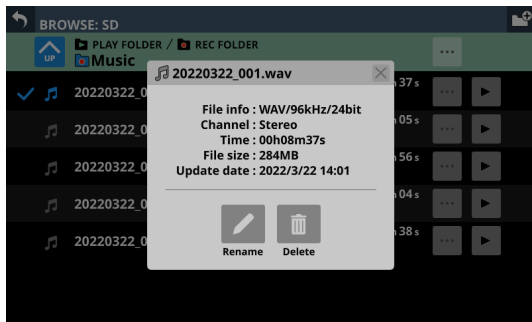

| Menu item | Explanation |
|-----------|--|
| Rename | This opens a screen where the name of the file to the left of the button can be changed. |
| Delete | This deletes the file to the left of the button. |

- This operation is not possible during recording and playback.
- Tap a button to the left of a folder to open a menu that enables the following operations on that folder.

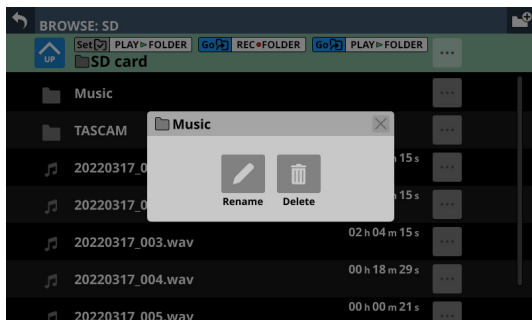

| Menu item | Explanation |
|-----------|--|
| Rename | This opens a screen where the name of the folder to the left of the button can be changed. |
| Delete | This deletes the folder to the left of the button. |

- This operation is not possible during recording and playback.

16 buttons

- Tap one of these buttons to select an audio file, make it subject to playback, and start playing it. The button will become highlighted green.
- Tap the button that is highlighted to stop playing the audio file.

17 Scrollbar

This appears when the number of folders and files exceeds the amount that can be shown on the display at the same time.

Drag the scrollbar to scroll the screen. The file list can also be scrolled by swiping it up and down as well as by turning LCD knob 8.

18 Media list

- This shows the media loaded in the unit.
- Tap this area to open the tapped media.

19 Media menu buttons

Tap these buttons to show information about the media to the left.

- Media volume name
- Various media capacity data

10 – Recording and playback

Setting the recording folder

1. Tap Menu Screen > Recorder/Player menu > Recorder/Player to open the RECORDER/PLAYER Screen.

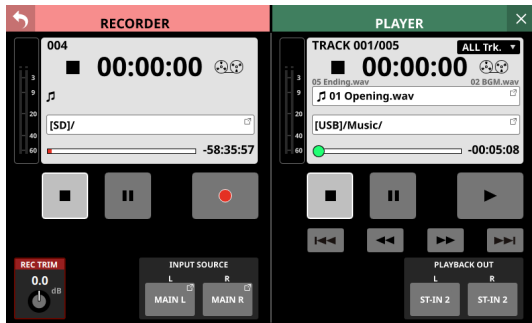

2. Tap the recording folder name (7) in the RECORDER Section to open the RECORDER BROWSE Screen.

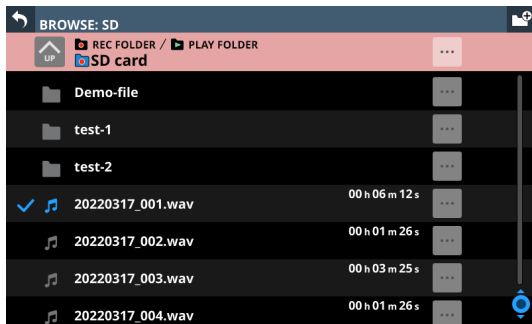

3. Tap the folder to be set as the recording folder. This opens the screen for the tapped folder.

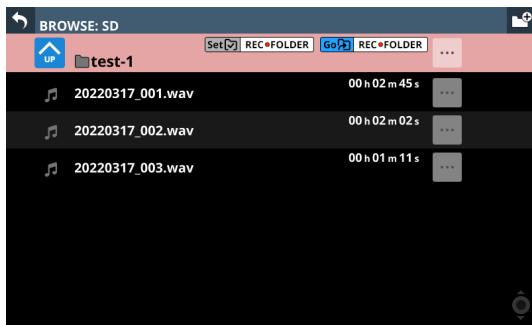

4. Tap the Set REC FOLDER button (9). This sets it as the recording folder, and "REC FOLDER" appears.



Setting the playback folder

1. Tap Menu Screen > Recorder/Player menu > Recorder/Player to open the RECORDER/PLAYER Screen.

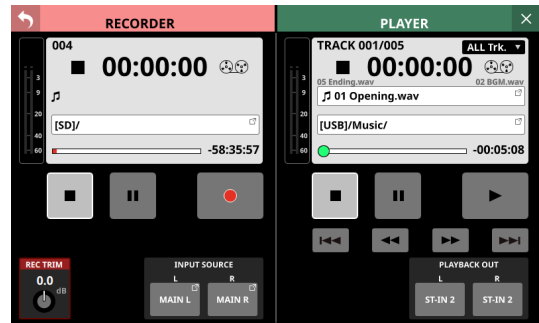

2. Tap the name of the current playback file (8) or the playback folder name (9) in the PLAYER Section to open the PLAYER BROWSE Screen.



3. Tap the folder to be set as the playback folder. This opens the screen for the tapped folder.

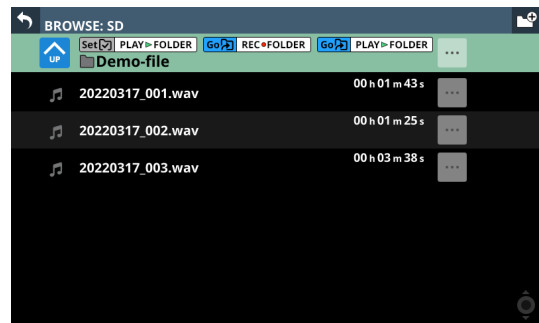

4. Tap the Set PLAY FOLDER button (9). This sets it as the playback folder, and "PLAY FOLDER" appears.

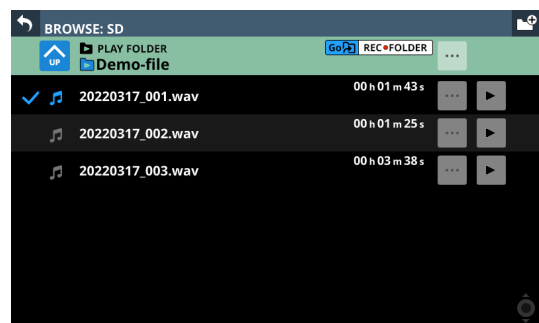

11 – USB audio interface functions

Installing the dedicated software

To use this unit as a USB audio interface with a Windows computer, dedicated software must be installed on the computer.

Download the latest software from the product page on the TEAC Global Site (<https://teac-global.com/>).

Installing the dedicated software will install a driver and the TASCAM Sonicview USB application.

ATTENTION

Before starting to install software, quit other applications.

NOTE

With a Mac, the standard OS driver will be used, so there is no need to install any software.

Installing the Windows dedicated software

Follow the procedures below to install the Windows dedicated software.

ATTENTION

- Complete installation of the Windows dedicated software on the computer before connecting the unit to it with the USB cable.
- If you connected the unit to the computer using the USB cable before installing the Windows dedicated software and the “Found New Hardware Wizard” launched, close the Wizard and disconnect the USB cable.

Windows dedicated software installation procedures

1. Download the latest Windows dedicated software from the TEAC Global Site (<https://teac-global.com/>) and save it on the computer to be used with the unit.
2. Uncompress the saved software (zip file) on the computer desktop or another location.
3. Double-click the “TASCAM Sonicview USB.exe” file in the folder that appears after uncompression to launch the installation software.

ATTENTION

If you open a zip file without decompressing it and doubleclick the “TASCAM Sonicview USB.exe” file in the folder that opens, installation will not start. Right-click the zip file and select “Extract All”, for example, to decompress it and then try again.

4. When a Security Warning or User Account Control screen appears, click the “Yes” button.

5. Read the contents of the User License Agreement, and select “I accept the agreement” if you agree to the terms. Then, click the “Next>” button.

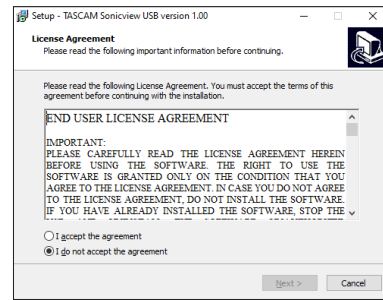

6. Next, click the “Install” button.

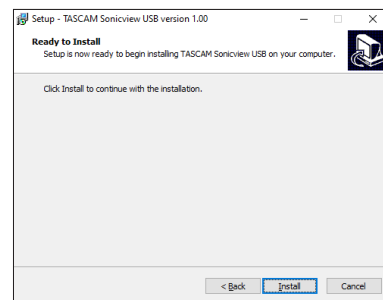

7. The following screen appears when installation has completed. Click the “Finish” button.

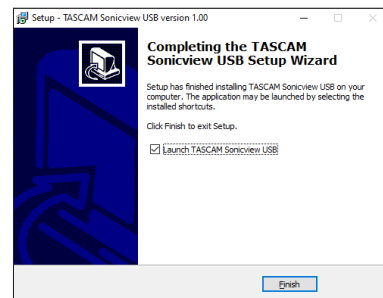

After installation completes, the installed TASCAM Sonicview USB software will launch.

NOTE

The first time you connect the unit by USB to the computer after installing the software, installation of the device driver will be executed. Some time might be necessary before the unit is recognized because Windows Update will be automatically searched at this time. If the unit is still not recognized after a while, open the software installation screen from the notification area at the bottom right of the computer display, and click “Skip obtaining driver software from Windows Update” to stop the search.

Uninstalling the dedicated software

NOTE

Normally, there is no need to uninstall the dedicated software. Follow these procedures if a problem occurs or you no longer intend to use the unit with the computer.

Uninstalling the Windows dedicated software

1. Open the “Uninstall or change a program” screen using the procedures for the operating system being used (Windows 11/Windows 10).
2. Select “TASCAM Sonicview USB ” from the list, and double-click it.
3. Then, follow the instructions that appear on the screen.

Opening the dedicated software

The dedicated TASCAM Sonicview USB software can be opened in the following manner.

Windows

- From the “Start” menu select “TASCAM Sonicview USB” under “TASCAM”.

Input latency

The amount of latency for audio input and output signals transferred to and from the computer can be adjusted using the ASIO driver.

Smaller values result in less audio signal delay, but require high-speed processing by the computer.

If the processing cannot keep up, for example, due to other system operations, clicking and popping noises might occur and the audio signal might even drop out.

Increasing the value will stabilize operation and suppress negative effects on audio signals, but the delay in audio signal transfer between the unit and the computer will increase.

The amount of latency for this unit can be adjusted according to use conditions.

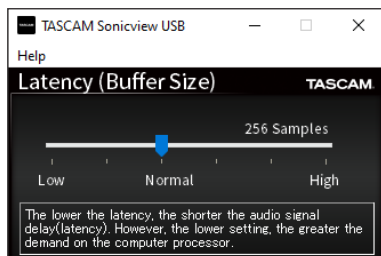

Default: Normal (256 Samples)

NOTE

On macOS, adjust this with application settings.

Setting Sound Properties

1. Open the Control Panel on the Windows computer.

NOTE

Follow these procedures to open the Control Panel.

Windows 11

Click the Windows Start button, and from “All apps” click “Windows Tools” and then double-click “Control Panel”.

Windows 10

Click the Windows Start button, and under “Windows System”, click “Control Panel”.

2. Double-click “Sound” in the Control Panel.

NOTE

If the Control Panel is set to be viewed as icons, a “Sound” icon will appear.

3. On the “Playback” page, right-click “Sonicview 16/24”, and click “Set as Default Device” in the pop-up menu that appears.

When you do this, the green check mark appears next to the selected device.

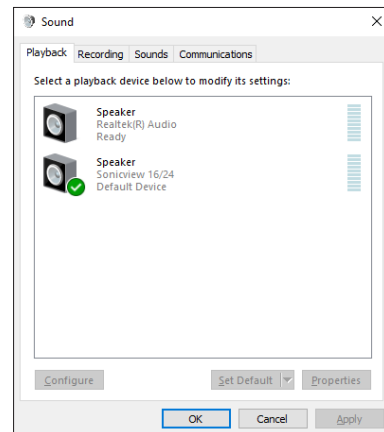

Windows 10 screen

NOTE

Set the default device according to the device being used on the Recording tab in the same manner as on the Playback tab.

4. After completing the setting, click the “OK” button.
5. Launch Windows Media Player and play an audio file to input the playback sound from the computer to USB IN 1 and 2 on the Sonicview 16/24.

NOTE

- If you change the setting while Windows Media Player is running, the software will not recognize that the device has been changed. In this case, restart Windows Media Player.
- If you still cannot hear sound after making the settings and completing the procedures above, restart the computer.
- If you make this setting, sound will be output through this unit, but no sound will be output from the computer’s speakers or headphone jack.

11 – USB audio interface functions

Simultaneous ASIO/WDM playback

The driver for this unit can simultaneously play ASIO output from a DAW and WDM output from Windows Media Player, for example. The sample rates of both sources must be set to the same value for simultaneous playback to be possible. Moreover, the sample rate must also be set to the same value for both playback and recording in the Windows Sound Properties.

When the sample rates are the same

Example: Windows (WDM) at 48000 Hz, ASIO at 48000 Hz
The Windows audio and ASIO sound are mixed and played simultaneously.

When the sample rates are different

Example: Windows (WDM) at 48000 Hz, ASIO at 96000 Hz
Only sound from a DAW and other ASIO sources are output. Sound from Windows Media Player and other WDM sources are not output.

When the DAW is shut down, for example, and output from ASIO sources stops, sound from Windows Media Player and other WDM sources will become audible.

Setting procedures for use with OBS Studio and other streaming applications

Conduct the procedures in this document before launching the streaming application.

Windows computer sound settings

Set the input and output device, sampling frequency, bit rate, and number of channels according to the setup.

1. Open the Sound Settings screen.

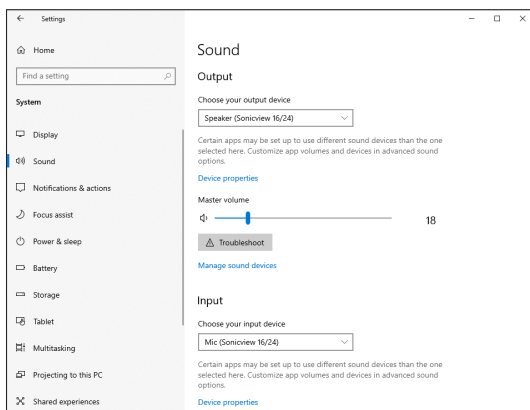

NOTE

This can also be opened by right-clicking the sound icon at the bottom right of the desktop screen, selecting "Open Sound settings" and then selecting "Sound".

2. Set the output device to "Speakers (Sonicview 16/24)".
3. Set the input device to "Microphone (Sonicview 16/24)".
4. Click "Sound Control Panel" to open the Sound window.
5. Open the Recording tab, and select "Sonicview 16/24".

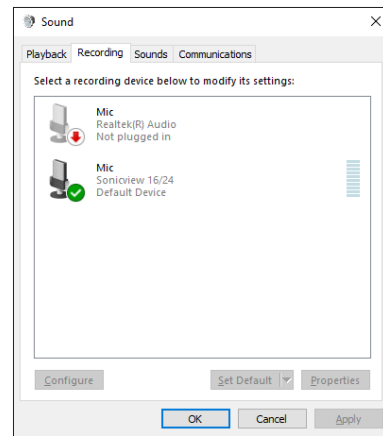

6. Click "Properties" for "Sonicview 16/24" to open the Microphone Properties screen.
7. Open the Advanced tab, and set the Default Format.

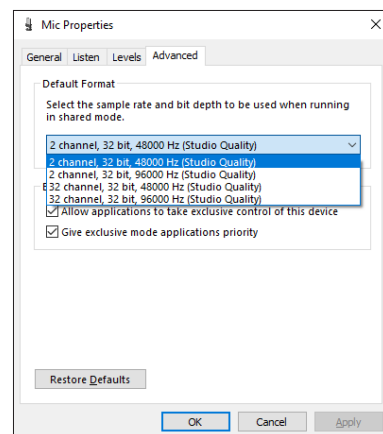

- Select a 2-channel setting when using OBS Studio or another application that supports 2-channel audio devices. Otherwise, select a 32-channel setting.
- Set the "Default Format" sample rate to match the sample rate of the application being used to stream

11 – USB audio interface functions

- Open the Playback tab, and select “Speakers (Sonicview 16/24)”.

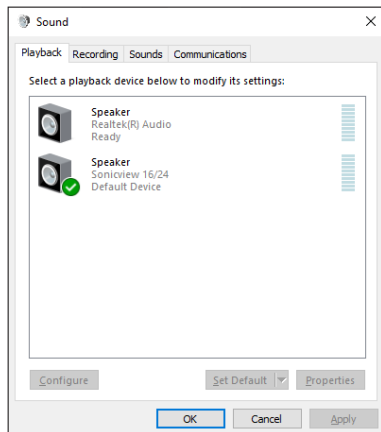

- Click “Properties” for “Speakers (Sonicview 16/24)” to open the Speakers Properties Screen.
- Open the Advanced tab, and set the Default Format. Set the sample rate and bit depth for the Default Device on the Play tab to the same values set on the Record tab.

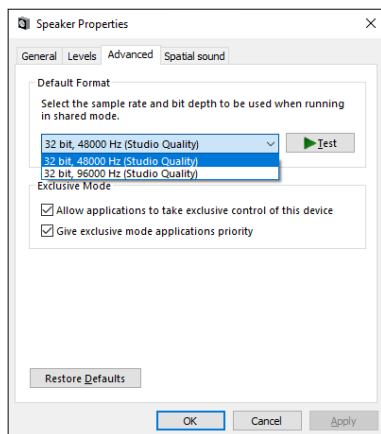

- Launch the streaming application, and proceed with streaming and other functions.
- After completing streaming, restore the settings to multichannel to use multiple channels with other applications as necessary.
 - In step 7, set the Microphone Properties to 32-channel.

12 – Multitrack Recorder

Multitrack recording with this unit can be enabled by installing an IF-MTR32 (multitrack recording) card in SLOT 1 or SLOT 2 on the rear panel.

The IF-MTR32 is a multitrack recorder (MTR) that is capable of recording up to 32 tracks (when the sampling rate is 48 kHz).

The recording/playback formats are as follows.

- File format: BWF/WAV (recording is always BWF), monophonic
- Sampling Rate: 48 kHz, 96 kHz
- Quantization bit depth
 - When recording: 24-bit or 32-bit
 - When playing: 16-bit*, 24-bit or 32-bit

* Quantization bit depth: 16-bit

Playback of imported files with this bit depth is supported only when the MTR operation mode is LIVE RECORDING MODE or VIRTUAL SOUND CHECK MODE. Recording at 16-bit is not supported. Moreover, punching in/out is not possible with imported 16-bit files, so they cannot be selected when the MTR operation mode is OVERDUB MODE.

Recording will be at the sampling frequency set on the MULTI TRACK RECORDER - MENU Screen. (See “② Sampling Rate (Max Tracks) buttons” on page 227.)

ATTENTION

Only one IF-MTR32 card can be used at a time.

If two IF-MTR32 cards are installed, only the one in SLOT 1 can be used.

Maximum recording time

| File format used | Media capacity | | | |
|---------------------------|----------------|--------|---------|---------|
| | 64GB | 128GB | 256GB | 512GB |
| 48kHz/24-bit/ 32-track | 3h 49m | 7h 41m | 15h 23m | 30h 49m |
| 48kHz/32-bit/ 32-track | 2h 52m | 5h 45m | 11h 32m | 23h 07m |
| 96kHz/24-bit/ 16-track | 3h 50m | 7h 41m | 15h 24m | 30h 50m |
| 96kHz/32-bit/ 16-track | 2h 52m | 5h 46m | 11h 33m | 23h 08m |

- The recording times shown above are estimates. They might differ depending on the media used.
- The recording times shown above are not continuous recording times, but rather they are the total possible recording times for the media.

NOTE

If the size of a recording file for a track exceeds 4 GB during recording, a new take will be created and recording will continue in that take.

Formatting SD cards

SD cards formatted by an IF-MTR32 are optimized to improve performance during recording. Use an IF-MTR32 to format SD cards to be used with an IF-MTR32. (See “⑥ Format buttons” on page 228.)

Errors might occur when recording with an IF-MTR32 using an SD card formatted by a computer or other device.

Projects and takes

With this multi track recorder (MTR), groups of files recorded at the same time are called “takes” and folders that contain recorded takes are called “projects”.

MTR operation modes

This MTR has the following three operation modes.

The operation mode can be changed by tapping the MTR operation (④) button on the MULTI TRACK RECORDER Screen. (See “Switching MTR operation mode” on page 224.)

LIVE RECORDING MODE

In this mode, takes can be recorded one at a time and multiple takes can be played back consecutively in a project.

VIRTUAL SOUND CHECK MODE

The routing with the MTR in this mode is limited to virtual sound check routing.

When recording, sound sources for virtual sound checks are recorded by recording the DIRECT OUT from the corresponding INPUT modules.

When the SOUND CHECK button appears highlighted, MTR playback output starts for the INPUT of the corresponding channels, enabling a virtual sound check.

NOTE

In this mode, the DIRECT OUT POINT is set to “INPUT”.

OVERDUB MODE

The routing with the MTR in this mode is limited to INSERT SEND/RETURN.

In this mode, overdubbing, including punching in/out, is possible with individual takes that have already been recorded.

MULTI TRACK RECORDER Screen

Use this screen to make settings and show the status of the IF-MTR32 (multitrack recorder) card installed in SLOT 1 or SLOT 2. Tap Menu Screen > Recorder/Player menu > Multi Track Recorder to open this screen. This screen can also be opened by tapping "Recorder/Player: MTR →" shown for the slot with the IF-MTR32 installed on the SLOT SETUP Screen.

NOTE

When the IF-MTR32 card is initializing, the "Multi Track Recorder" sub menu item will be shown in gray on the Menu Screen, and the MULTI TRACK RECORDER Screen will not open even if it is tapped. Wait a while until it becomes usable.

When in LIVE RECORDING MODE or VIRTUAL SOUND CHECK MODE

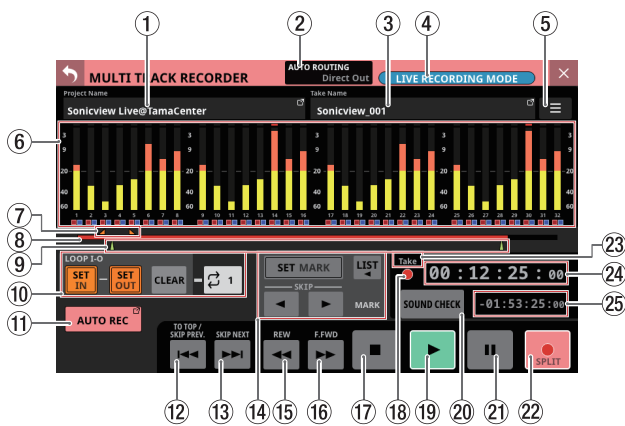

Screen appearance in LIVE RECORDING MODE

When in OVERDUB MODE

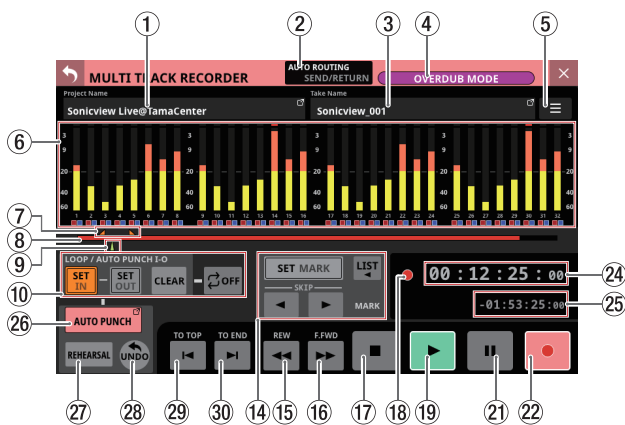

① Project Name

- This shows the name of the currently open project.
- Tap this area when the MTR is stopped to open the BROWSE MTR Screen, which shows a project list. (See "Selecting projects" on page 232.)

② AUTO ROUTING button

Tap this button when the MTR is stopped to open an AUTO ROUTING confirmation message. (See "Using the AUTO ROUTING function" on page 222.)

③ Take Name

- This shows the name of the currently open take.
- Tap this area when the MTR is stopped to open the BROWSE MTR Screen, which shows a list of takes in the current project. (See "MULTI TRACK RECORDER - BROWSE Screen" on page 229.)



④ MTR operation mode button

- This shows the current MTR operation mode.
 - LIVE RECORDING MODE
 - VIRTUAL SOUND CHECK MODE
 - OVERDUB MODE
- Tap this button when the MTR is stopped to open the MTR operation mode switching menu. (See "Using the AUTO ROUTING function" on page 222.)

⑤ MTR menu button (☰)

Tap this button when the MTR is stopped to open the dedicated MTR Menu Screen. (See "MULTI TRACK RECORDER - MENU Screen" on page 227.)

⑥ Meters and REC READY/INPUT MONITOR indicator area

- This area shows the meters and REC READY/INPUT MONITOR states of each track.
- 32 tracks are shown when the Sampling Rate (Max Tracks) button (②) setting is "48kHz/32tracks" on the MULTI TRACK RECORDER-MENU Screen, and 16 tracks are shown when this is set to "96kHz/16tracks". (See "MULTI TRACK RECORDER - MENU Screen" on page 227.)
- Each meter has an overload indicator at its top. They will appear to light red when the signal level reaches or exceeds -0.00026 dBFS (16-bit full-scale value).
- When a level overload occurs, the entire bar meter will light red.
- The area below -60 dBFS at the bottom of the level meters will light when above -70 dBFS.
- When REC READY is on, the  icon below the meter will appear red.
- When INPUT MONITOR is on, the  icon below the meter will appear blue.
- Tap this area to open a REC READY / INPUT MONITOR settings window below the meters for the group of 8 tracks in the area tapped. (See "REC READY/INPUT MONITOR settings" on page 225.)

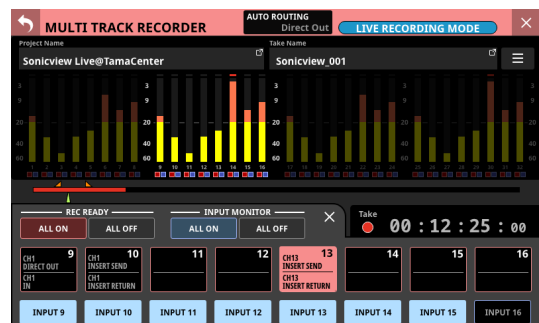

12 – Multitrack Recorder

⑦ IN/OUT mark display area

The IN (■) and OUT (■) points in the take are shown above the time progress bar.

⑧ Progress bar

- When recording, the amount of space already used as a proportion of the total space on the media is shown as a red bar. As recording progresses, the red bar extends from the left to the right.
- When playing, the current playback position relative to the length of the project or take being played (depending on the time display mode) is shown as a green bar. Dragging it changes the playback position.

⑨ Mark indicator area

The marks (▲) in the take are shown below the progress bar.

When the time display mode is PROJECT, only marks in the take that is currently playing are shown.

⑩ IN/OUT point setting area

Use this area to set IN/OUT points and the repeat mode.

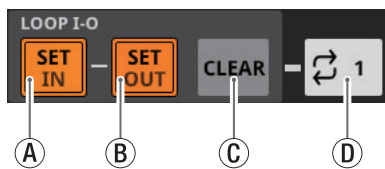

Ⓐ SET IN button

- When tapped, this sets the IN point at the current recording/playback time. If an IN point has already been set, tapping this will reset the IN point.
- This will be used as the I-O repeat point when the MTR operation mode is LIVE RECORDING MODE or VIRTUAL SOUND CHECK MODE.
- This will be used as either the I-O repeat point or the auto punch in point when the MTR operation mode is OVERDUB MODE.

Ⓑ SET OUT button

- When tapped, this sets the OUT point at the current recording/playback time. If an OUT point has already been set, tapping this will reset the OUT point.
- This will be used as the I-O repeat point when the MTR operation mode is LIVE RECORDING MODE or VIRTUAL SOUND CHECK MODE.
- This will be used as either the I-O repeat point or the auto punch out point when the MTR operation mode is OVERDUB MODE.

Ⓒ CLEAR button

This clears the IN/OUT points.

Ⓓ Repeat mode setting button

This sets the repeats playback function mode.

- When the MTR operation mode is LIVE RECORDING MODE or VIRTUAL SOUND CHECK MODE, tap this to cycle through these options: OFF, 1, ALL and I-O.
- When the MTR operation mode is OVERDUB MODE, tap this to cycle through these options: OFF, 1, and I-O. Repeat playback is not possible, however, when the AUTO PUNCH button is set to "ON".

| Repeat mode | Function |
|-------------|--|
| | Playback will not be repeated. |
| | The entire take that is currently selected will be played repeatedly. |
| | The entire project will be played repeatedly. This can be selected when the MTR operation mode is LIVE RECORDING MODE or VIRTUAL SOUND CHECK MODE. |
| | Playback will be repeated between the IN and OUT points. |

NOTE

- Set the in and out points at least 200 ms apart. If the interval is less than 200 ms, the following message will appear and the later point will not be set.

Invalid I/O. Interval too short.

- Trying to set the out point before the in point or the in point after the out point will fail and the following message will appear. Set the in point so that it is before the out point.

Invalid I/O. Please set IN and OUT in order.

- If the MTR operation mode is switched to OVERDUB MODE when the repeat mode is set to ALL, the repeat mode will be automatically switched to OFF.

⑪ AUTO REC button and indicator

When the MTR is stopped, tap this button to open the MULTI TRACK RECORDER-MENU Screen where automatic recording settings are made. When automatic recording is on, this appears light red.

⑫ ◀◀ (TO TOP/SKIP PREV.) button

- Tap this when playing or paused to return to the beginning of the current take.
- Tap this when a take is stopped at its beginning to skip to the beginning of the previous take.
- The button will appear white while it is being touched.

⑬ ▶▶ (SKIP NEXT) button

- Tap this when stopped, playing or paused to skip to the next take.
- The button will appear white while it is being touched.

12 – Multitrack Recorder

14 MARK setting area

Use this area to make mark function settings.

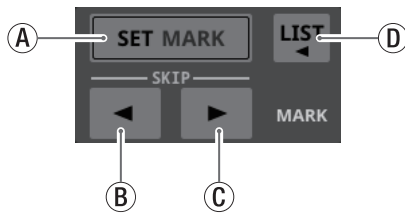

- A** SET MARK button
This sets a mark at the current recording/playback time.
- B** ◀ MARK SKIP button
Use this to move to the position of the nearest mark that is before the current playback position.
- C** ▶ MARK SKIP button
Use this to move to the position of the nearest mark that is after the current playback position.
- D** LIST button
Tap this button to open a window that shows mark list information.

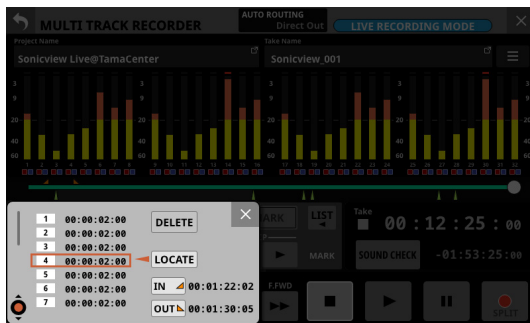

See “Editing takes” on page 239 for details.

15 ◀◀ (REW) button

- When stopped, playing back or playback is paused, tap this button to start searching backward. Touch this button continuously to search while it is being touched.
- Tap this button when searching backward to stop.
- The button will appear white while it is being touched.

16 ▶▶ (F.FWD) button

- When stopped, playing back or playback is paused, tap this button to start searching forward. Touch this button continuously to search while it is being touched.
- Tap this button when searching forward to stop.
- The button will appear white while it is being touched.

17 ■ button

- Tap this when recording/playing to stop recording/playing.
- When stopped, this button will appear white.

18 Transport status indicator

This icon shows the MTR operation status.

| Indicator appearance | Operation status |
|----------------------|--------------------|
| ■ | Stopped |
| ▶ | Playing |
| ◀◀ | Searching backward |
| ▶▶ | Searching forward |
| ● | Recording |

19 ▶ button

- Tap this when playback is stopped or paused to start playback.
- Tap this when recording is paused to resume recording.
- When recording or playing, this button will appear green.

20 SOUND CHECK button

- When the MTR is stopped, tap this button to switch between routing for recording and routing for sound checks (MTR playback).

| Button appearance | Routing status |
|-------------------|-----------------------|
| | Routing for recording |
| | Routing for playback |

NOTE

- Recording is not possible when the SOUND CHECK button is on.
- The MTR must be stopped to change the SOUND CHECK status. The following message will appear if changing the SOUND CHECK status is attempted while the MTR is operating.

To change, the MTR must be stopped.

- Tap this button to open a message that confirms switching the routing.

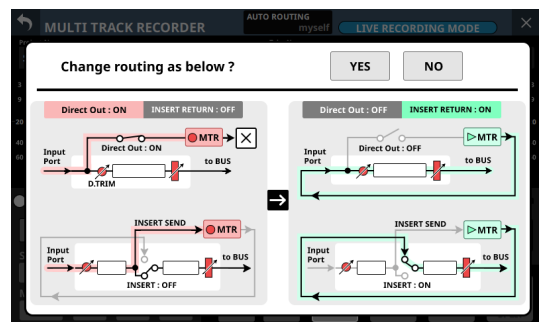

Example of confirmation message when turning on the SOUND CHECK button

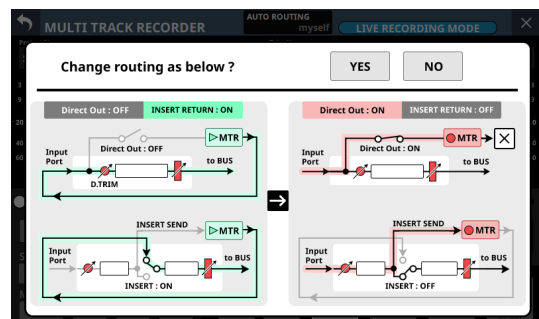

Example of confirmation message when turning off the SOUND CHECK button

- Tapping the YES button on the confirmation message will switch the routing and button status.
- Tapping the NO button will close the message without changing the routing or button status.

12 – Multitrack Recorder

NOTE

The routing can be changed by turning the SOUND CHECK button on/off even if the lock/unlock setting for changing routing settings is locked on the MODULE (INPUT) Screen or INPUT SOURCE SELECT Screen, for example.

MTR routing when using CH DIRECT OUT (When DIRECT OUT POINT is INPUT)

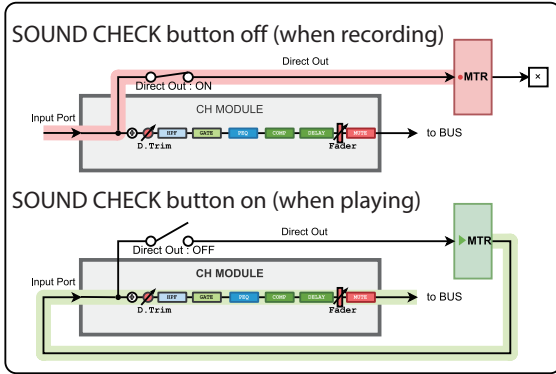

MTR routing when using CH INSERT SEND/RETURN (When INSERT POINT is PRE EQ)

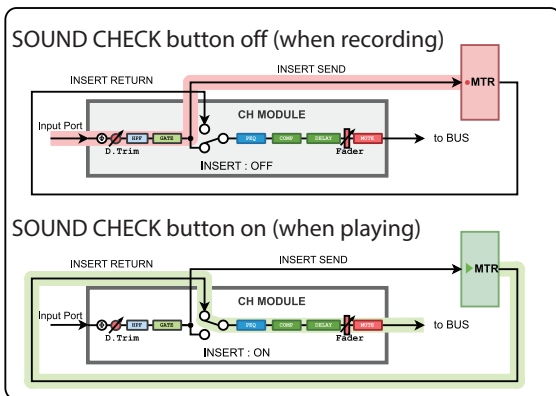

MTR routing when using BUS INSERT SEND/RETURN

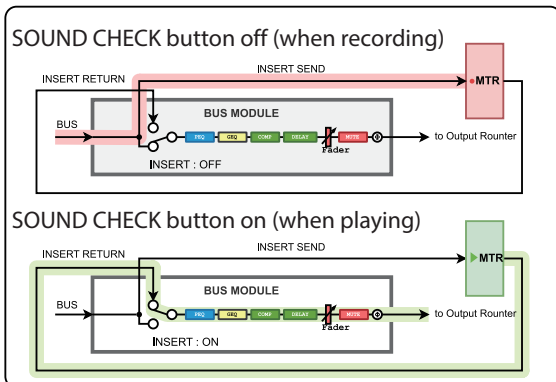

MTR routing when using BUS OUT

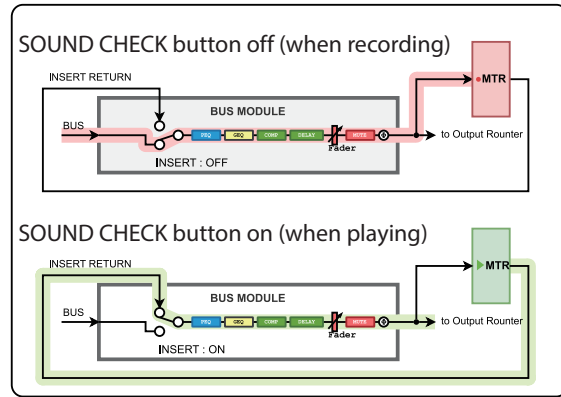

- When recording the DIRECT OUT if the DIRECT OUT POINT setting is "POST HPF"*
Use caution because signals will pass through Phase/D. Trim/HPF again during sound check (playback) if Phase/D. Trim/HPF is enabled during recording.
- When recording the DIRECT OUT if the DIRECT OUT POINT setting is "POST FADER"*
Use caution because signals will pass through Phase/D. Trim/HPF/GATE/EQ/COMP/DELAY again during sound check (playback) if Phase/D. Trim/HPF/GATE/EQ/COMP/DELAY is enabled during recording.
- * Issues like the above will not occur when the DIRECT OUT POINT setting is "INPUT".
- When recording the BUS Output Port
Use caution because signals will pass through EQ/GEQ/COMP/DELAY/Phase again during sound check (playback) if EQ/GEQ/COMP/DELAY/Phase is enabled when recording the BUS Output Port.
To avoid two routes for processing the signals when recording and when playing back with the BUS module, set the routing from the BUS module to the MTR to "Insert Send".

②1 II button

- Tap this when stopped or playing to pause playback.
- When the MTR operation mode is LIVE RECORDING MODE or VIRTUAL SOUND CHECK MODE, tap when recording to pause recording.
- This cannot be used during recording when the MTR operation mode is OVERDUB MODE.
- When recording or playback is paused, this button will appear white.

22 ● button

- Tap this when stopped and at least one REC READY is on to put the unit into recording standby.
- If the MTR operation mode is LIVE RECORDING MODE or VIRTUAL SOUND CHECK MODE, tapping this when recording will not interrupt recording, but will end the current take and start a new take (take splitting).
- When the MTR operation mode is LIVE RECORDING MODE or VIRTUAL SOUND CHECK MODE, tap this when in recording standby to start a new take and remain in recording standby.
- When the MTR operation mode is OVERDUB MODE and at least one REC READY is on, tap this when playing to punch in and start recording.
- When recording or paused, this button will appear light red.

23 Time counter display mode

- This shows the current time counter display mode.
- Tap this area to switch the display mode.

| Display mode | Meaning |
|--------------|---|
| TAKE | This shows the elapsed time from the beginning of the take and the remaining time to the end of the take. |
| PROJECT | This shows the elapsed time from the beginning of the project and the remaining time to the end of the project. |

24 Elapsed time counter

- This shows the elapsed recording/playback time in an hour: minute: second: 1/100 second format.
- Tap the counter to switch to location time input mode and show number input and LOCATE buttons below it. Tap the LOCATE button to locate immediately to the input time.
- Tap the × button at the top right of the locate time input area to close it.

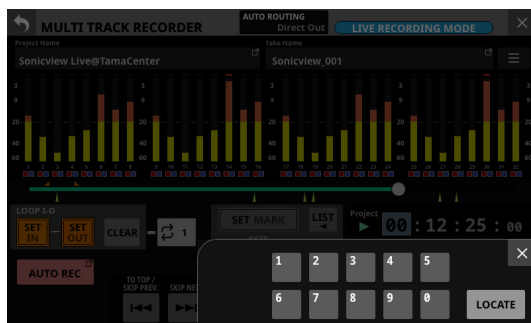

25 Remaining time counter

- When the MTR operation mode is LIVE RECORDING MODE or VIRTUAL SOUND CHECK MODE
 - During playback, this shows the remaining time until the end of the take or project according to the selected display mode in an hour: minute: second: 1/100 second format.
 - When recording, this shows the remaining available recording time.
- When the MTR operation mode is OVERDUB MODE
 - This shows the remaining available recording time.

26 AUTO PUNCH button/indicator

Tap this button to open the MULTI TRACK RECORDER-MENU Screen where settings for operation of the auto punch in/out function are made. (See "Automatic punch in/out function" on page 237.)

When on, this appears light red.

27 REHEARSAL button

- Tap this button to turn the auto punch in/out rehearsal function on/off. (See "Rehearsing punching in and out" on page 238.)
- This will blink when the rehearsal function is on.
- This button can only be used when the automatic punch in/out function is on.

28 UNDO/REDO button

- Tap this button when it appears lit to use the UNDO/REDO function. The UNDO button appears when UNDO is possible. The REDO button appears when UNDO has been used.
- When this button appears unlit, UNDO and REDO are not possible.

29 ◀ (TO TOP) button

- Tap this when stopped, playing or paused to return to the beginning of the take.
- The button will appear white while it is being touched.

30 ▶ (TO END) button

- Tap this when stopped, playing or paused to skip to the end of the take.
- The button will appear white while it is being touched.

12 – Multitrack Recorder

Using the AUTO ROUTING function

Tap the AUTO ROUTING (Ⓜ) button at the top of the MULTI TRACK RECORDER Screen to use this function. The AUTO ROUTING confirmation message below will be shown.

NOTE

- AUTO ROUTING cannot be executed if the SOUND CHECK button is on (playback routing enabled). Turn the SOUND CHECK button off to enable the execution of AUTO ROUTING.
- The routing can be changed with AUTO ROUTING even if the lock/unlock setting for changing routing settings is locked on the MODULE (INPUT) Screen and INPUT SOURCE SELECT Screen, for example.

When in LIVE RECORDING MODE

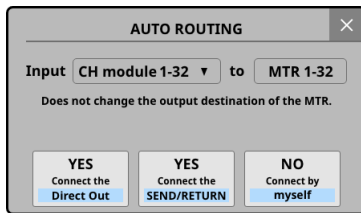

First, select “CH module 1–32” or “CH module 9–40”. If the Sampling Rate (Max Tracks) button setting is “96kHz/16tracks” on the MULTI TRACK RECORDER–MENU Screen, select “CH module 1–16” or “CH module 25–40”.

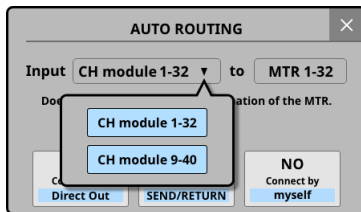

- Tap the “YES Connect the Direct Out” button to route the DIRECT OUT connections of the selected CH module group to 1–32 of the slot with the IF-MTR32 installed. If the Sampling Rate (Max Tracks) button setting is “96kHz/16tracks” on the MULTI TRACK RECORDER–MENU Screen, routing will be to 1–16 of the slot.

- Tap the “YES Connect the SEND/RETURN” button to route the INSERT SEND/RETURN connections of the selected CH module group to 1–32 of the slot with the IF-MTR32 installed. If the Sampling Rate (Max Tracks) button setting is “96kHz/16tracks” on the MULTI TRACK RECORDER–MENU Screen, routing will be to 1–16 of the slot. In this case, the metering points of the CH module groups will be automatically switched according to the insert point settings as shown below.

| Insert point setting for the selected CH module group | CH module group metering point |
|---|--------------------------------|
| All PRE EQ | PRE EQ |
| All PRE FADER | PRE FADER |
| Mix of PRE EQ and PRE FADER | PRE FADER |

- Tapping the “NO Connect by myself” button will keep the current routing settings, so make necessary routing changes manually.
- Tapping the [X] button will close the message without changing routing settings.

When in VIRTUAL SOUND CHECK MODE

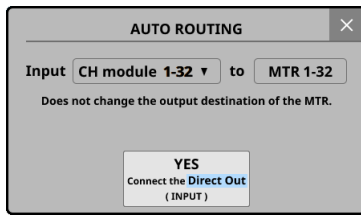

First, select “CH module 1–32” or “CH module 9–40”.
If the Sampling Rate (Max Tracks) button setting is “96kHz/16tracks” on the MULTI TRACK RECORDER–MENU Screen, select “CH module 1–16” or “CH module 25–40”.

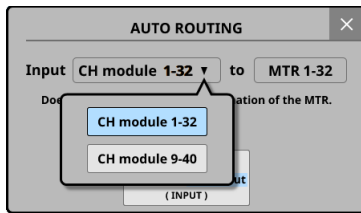

- Tap the “YES Connect the Direct Out (INPUT)” button to route DIRECT OUT connections that have DIRECT OUT POINT set to “INPUT” of the selected CH module group to 1–32 of the slot in which the IF-MTR32 is installed.
If the Sampling Rate (Max Tracks) button setting is “96kHz/16tracks” on the MULTI TRACK RECORDER–MENU Screen, routing will be to 1–16 of the slot.
- Tapping the  button will close the message without changing routing settings.

When in OVERDUB MODE

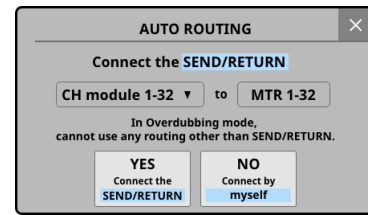

First, select “CH module 1–32” or “CH module 9–40”.
If the Sampling Rate (Max Tracks) button setting is “96kHz/16tracks” on the MULTI TRACK RECORDER–MENU Screen, select “CH module 1–16” or “CH module 25–40”.

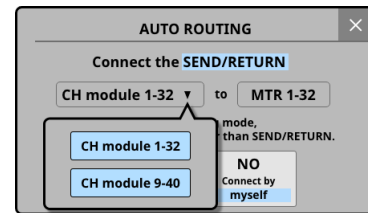

- Tap the “YES Connect the SEND/RETURN” button to route the INSERT SEND/RETURN connections of the selected CH module group to 1–32 of the slot with the IF-MTR32 installed.
If the Sampling Rate (Max Tracks) button setting is “96kHz/16tracks” on the MULTI TRACK RECORDER–MENU Screen, routing will be to 1–16 of the slot.
In this case, the metering points of the CH module groups will be automatically switched according to the insert point settings as shown below.

| Insert point setting for the selected CH module group | CH module group metering point |
|---|--------------------------------|
| All PRE EQ | PRE EQ |
| All PRE FADER | PRE FADER |
| Mix of PRE EQ and PRE FADER | PRE FADER |

- Tapping the “NO Connect by myself” button will keep the current routing settings, so make necessary routing changes manually.
- Tapping the  button will close the message without changing routing settings.

NOTE

When the MTR operation mode is OVERDUB MODE, always use “Insert Send/Return” for routing between the mixer and the MTR.

Normal punch in/out recording will not be possible using different routing settings.

12 – Multitrack Recorder

Switching MTR operation mode

To switch between the three MTR operation modes, when the MTR is stopped, tap the MTR operation (4) button on the MULTI TRACK RECORDER Screen.

This will open the MTR operation mode switching menu.

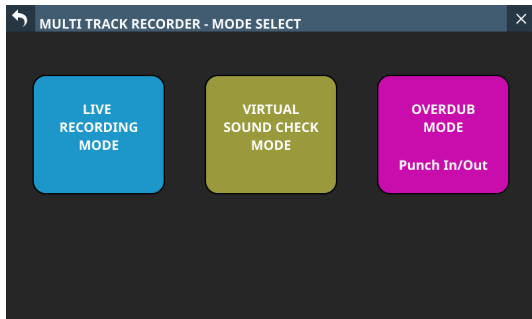

Tap one of the operation mode buttons to switch to that mode and open an AUTO ROUTING confirmation screen. (See "Using the AUTO ROUTING function" on page 222.)

Tap the button at the top left to return to the previous screen without changing the MTR operation mode.

NOTE

- MTR must be stopped to change the MTR operation mode. The following message will appear if changing the MTR operation mode is attempted while the MTR is operating.

To change, the MTR must be stopped.

- SOUND CHECK must be "OFF" to change the MTR operation mode. The following message will appear if changing the MTR operation mode is attempted while SOUND CHECK is "ON".

To change, SOUND CHECK must be OFF.

- At least one take is necessary to record in OVERDUB MODE. For this reason, if the current project has no takes, switching to OVERDUB MODE will cause the following message to be shown.

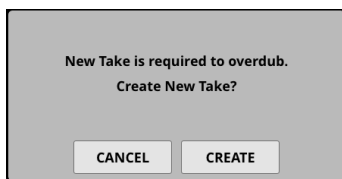

1. Tap the CREATE button to open the following confirmation message.

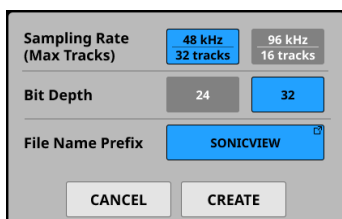

2. Set the Sampling Rate, Bit Depth and File Name Prefix.

3. Tap the CREATE button to create a take.
Tap the CANCEL button to open the MULTI TRACK RECORDER Screen without creating a take.

- If the CANCEL button was tapped in any of the above confirmation messages

1. The following message will be shown when switching to the MULTI TRACK RECORDER Screen or if the MULTI TRACK RECORDER Screen button is tapped to start recording.



- Tap the CREATE button to open the following confirmation message.

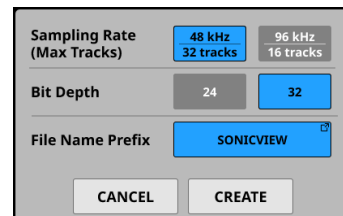

Set the Sampling Rate, Bit Depth and File Name Prefix, and tap the CREATE button to create a take and put the recorder in standby.

- Tapping the CANCEL button on any of the above confirmation messages will restore it to a stopped state.

2. Tap the button at the top right of the take list on the MTR BROWSE Screen to open the following confirmation message.

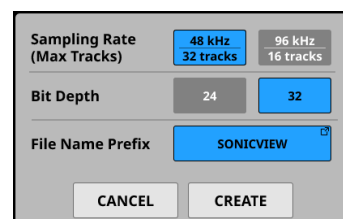

- Set the Sampling Rate, Bit Depth and File Name Prefix, and tap the CREATE button to create a take.
- Tap the CANCEL button to close the confirmation message without creating a take.

REC READY/INPUT MONITOR settings

Tap the MULTI TRACK RECORDER Screen meter/REC READY/ INPUT MONITOR area (6) to open a REC READY / INPUT MONITOR settings window below the meters for the group of 8 tracks in the area tapped.

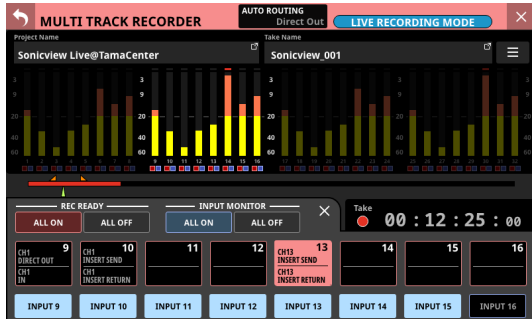

- REC READY setting buttons are in the upper row and INPUT MONITOR setting buttons are in the lower row for the selected 8 tracks.
- Tap these buttons to turn them on/off.
- The REC READY setting buttons show the routing settings for the tracks as follows.
 - Top line: Track input signal
 - Bottom line: Track signal output destination
- Tap the **X** button at the top right of the REC READY / INPUT MONITOR settings window to close the window and restore the normal MULTI TRACK RECORDER Screen.
- When INPUT MONITOR is on, the signal input to the MTR will be output from the MTR as is, regardless of the MTR operation status and REC READY on/off status.

- When REC READY is on
 - When stopped or recording, sound input to the MTR will be output from the MTR as is.
 - During playback, the MTR playback sound is output from the MTR.
- Tap the REC READY ALL ON/ALL OFF button to turn it on/off for all tracks. The ALL ON and ALL OFF buttons show the REC READY setting status.

| REC READY setting status | ALL ON button appearance | ALL OFF button appearance |
|--|--------------------------|---------------------------|
| When all tracks are on | | |
| When all tracks are off | | |
| When some tracks are on and some are off | | |

- Tap the INPUT MONITOR ALL ON/ALL OFF button to turn it on/off for all tracks. The ALL ON and ALL OFF buttons show the INPUT MONITOR setting status.

| INPUT MONITOR setting status | ALL ON button appearance | ALL OFF button appearance |
|--|--------------------------|---------------------------|
| When all tracks are on | | |
| When all tracks are off | | |
| When some tracks are on and some are off | | |

12 – Multitrack Recorder

MTR output according to REC READY and INPUT MONITOR settings

When in LIVE RECORDING MODE or VIRTUAL SOUND CHECK MODE

| | | | | |
|-----------------------------------|---|---|---|--|
| | REC READY | | | |
| | <input type="checkbox"/> Off | <input checked="" type="checkbox"/> On | <input type="checkbox"/> Off | <input checked="" type="checkbox"/> On |
| | INPUT MONITOR | | | |
| | <input type="checkbox"/> Off | <input checked="" type="checkbox"/> Off | <input checked="" type="checkbox"/> On | <input checked="" type="checkbox"/> On |
| When stopped | No MTR output | Sound input to the MTR is output from the MTR | Sound input to the MTR is output from the MTR | |
| Playing/playback paused | MTR playback sound is output from the MTR | MTR playback sound is output from the MTR | | |
| Recording/recording paused | No MTR output | Sound input to the MTR is output from the MTR | | |

When in OVERDUB MODE

| | | | | |
|-----------------------------------|---|---|---|--|
| | REC READY | | | |
| | <input type="checkbox"/> Off | <input checked="" type="checkbox"/> On | <input type="checkbox"/> Off | <input checked="" type="checkbox"/> On |
| | INPUT MONITOR | | | |
| | <input type="checkbox"/> Off | <input checked="" type="checkbox"/> Off | <input checked="" type="checkbox"/> On | <input checked="" type="checkbox"/> On |
| When stopped | No MTR output | Sound input to the MTR is output from the MTR | Sound input to the MTR is output from the MTR | |
| Playing/playback paused | MTR playback sound is output from the MTR | MTR playback sound is output from the MTR | | |
| Recording/recording paused | MTR playback sound is output from the MTR | Sound input to the MTR is output from the MTR | | |

Yellow cells: Setting combinations that have different results in LIVE RECORDING MODE / VIRTUAL SOUND CHECK MODE and in OVERDUB MODE

MULTI TRACK RECORDER - MENU Screen

Use this screen to make various settings for the IF-MTR32 (multitrack recorder) card installed in SLOT 1 or SLOT 2.

To open this screen, tap Menu Screen > Recorder/Player menu > Multi Track Recorder to open the MULTI TRACK RECORDER Screen. Then, tap the  button at the top right when the MTR is stopped.

MTR - MENU Screen when in LIVE RECORDING MODE

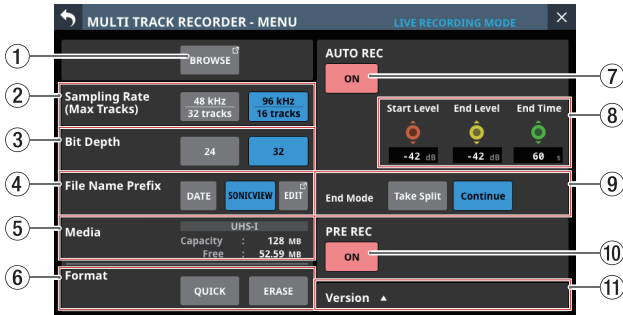

MTR - MENU Screen when in OVERDUB MODE

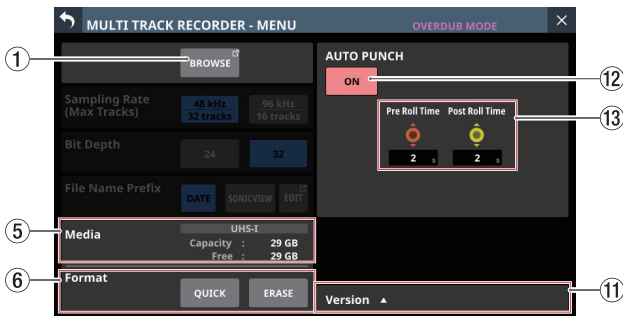

① BROWSE button

Tap this button to open the BROWSE MTR Screen. (See “MULTI TRACK RECORDER - BROWSE Screen” on page 229.)

② Sampling Rate (Max Tracks) buttons

This sets the sampling frequency and maximum number of tracks when the MTR operation mode is LIVE RECORDING MODE or VIRTUAL SOUND CHECK MODE.

The selected button will be highlighted light blue.

Options: 48 kHz / 32 tracks (default), 96 kHz / 16 tracks

NOTE

The sampling frequency for the IF-MTR32 can be set to a value different from the Sync Clock of the Sonicview 16/24 that it is installed in.

Since the number of tracks that can be recorded/played changes when this setting is switched, a routing change confirmation message will appear as shown below.

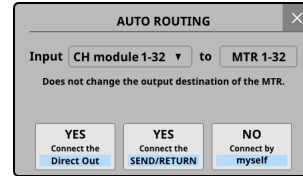

Message when switching to 48 kHz / 32 tracks

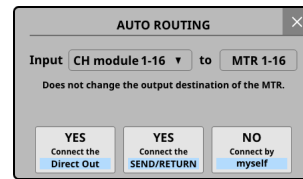

Message when switching to 96 kHz / 32 tracks

③ Bit Depth buttons

This setting will be used for the bit depth when the MTR operation mode is LIVE RECORDING MODE or VIRTUAL SOUND CHECK MODE.

The selected button will be highlighted light blue.

Options: 24-bit, 32-bit (default)

④ File Name Prefix buttons

This setting will be used for the first characters of recording file names when the MTR operation mode is LIVE RECORDING MODE or VIRTUAL SOUND CHECK MODE.

The selected button will be highlighted light blue.

| Option | Meaning |
|----------------|--|
| DATE (default) | The year, month and day that the recording started will be added to the recording file name in YYYYMMDD format. |
| Edit Name | The file name set by the user will be used as the recording file name (SONICVIEW by default). The set name is shown on the button. Tap the EDIT button on the right to open the Edit Name Screen where the file name set by the user can be edited. |

⑤ Media status

This shows the status of the SD card loaded in the IF-MTR32.

| Item | Explanation |
|----------|--|
| UHS-I | This area will appear lit if the card supports UHS-I. |
| Capacity | Shows the total amount of space on the SD card. |
| Free | This shows the amount of unused capacity on the SD card. |

12 – Multitrack Recorder

⑥ Format buttons

Use these to format the SD card loaded in the IF-MTR32. We recommend using the ERASE option to format SD cards when using them with the IF-MTR32 for the first time.

- Tap the QUICK button to format only the application management area on the medium.
- Tap the ERASE button to conduct erase formatting.

ATTENTION

Formatting will erase all the data on the SD card. Back up to a computer, for example, before formatting a card.

NOTE

- ERASE formatting takes more time than QUICK formatting. We recommend doing this when plenty of time is available.
- The writing speeds to SD cards and other storage media that use flash memory tend to decrease after writing occurs repeatedly. If the writing speed decreases, this could have a negative impact on recording.

Using the ERASE formatting function of this unit should restore the writing speed of the SD card.*

For this reason, we recommend using the ERASE formatting function at the following times.

- If the following message appears when recording

MTR Recording Error. Buffer overflow.

- Whenever the card has been written to until it became completely full
- On a regular schedule (about once per month)
- Before starting important recordings

* Writing speed might not be restored depending on the SD card condition (including malfunction and age).

⑦ AUTO REC button

Tap this button to turn the automatic recording function on/off (default).

When on, this button will appear red.

See "Automatic recording function" on page 236 for details.

⑧ Automatic recording function setting knobs

Use these to set the automatic recording operation levels and time.

● Start Level knob

This sets the level for starting automatic recording. Use LCD knob 6, which is lit red, to set this. (See "Automatic recording function" on page 236.)

Options: OFF*, -72 dBFS – -24 dBFS
(in 6dBFS increments, -42 dBFS default)

* When "OFF" is selected, tap the ● button on the MULTI TRACK RECORDER Screen to start recording.

● End Level knob

This sets the level for ending automatic recording. Use LCD knob 7, which is lit yellow, to adjust it. (See "Automatic recording function" on page 236.)

Options: OFF*, -72 dBFS – -24 dBFS
(in 6dBFS increments, -42 dBFS default)

* When "OFF" is selected, tap the ■ button on the MULTI TRACK RECORDER Screen to stop recording.

● End Time knob

This sets the time until automatic recording stops after the recording level goes below the End Level. Use LCD knob 8, which is lit green, to adjust it. (See "Automatic recording function" on page 236.)

If the recording level goes above the End Level before this time elapses, recording will continue.

Range: 1 – 60 seconds (default: 5 seconds)

⑨ End Mode buttons

Tap one of these buttons to set what happens when automatic recording has started and the End Time has elapsed after the recording level has gone below the End Level. (See "Automatic recording function" on page 236.)

| Option | Meaning |
|----------------------|--|
| Take Split (default) | Standby for recording in a new file |
| Continue | Standby for recording in the same file |

The selected button will be highlighted light blue.

⑩ PRE REC button

Tap this button to turn the pre-recording function on/off. (default: OFF)

When on, this button will appear red.

See "Pre-recording function" on page 236 for details.

⑪ Version button

Tap this button to open a window that shows information about the IF-MTR32 firmware version.

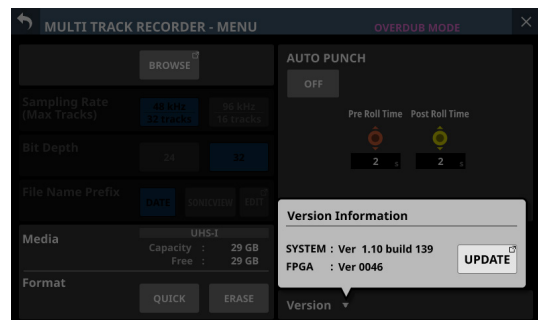

Tap the UPDATE button to open the Firmware Update Screen for the slot with the IF-MTR32 installed.

⑫ AUTO PUNCH button

Tap this button to turn the auto punch in/out function ON/OFF (default).

When on, this button will appear red.

See "Automatic punch in/out function" on page 237 for details.

⑬ Auto punch in/out function setting knobs

Use these to set the auto punch in/out function operation times. (See "Automatic punch in/out function" on page 237.)

● Pre Roll Time knob

This sets the pre-roll time for the auto punch in.

Use LCD knob 6, which is lit red, to set this.

Range: 0 – 10 seconds (default: 2 seconds)

● Post Roll Time knob

This sets the post roll time for the auto punch out.

Use LCD knob 7, which is lit yellow, to adjust it.

Range: 0 – 10 seconds (default: 2 seconds)

MULTI TRACK RECORDER - BROWSE Screen

Use this screen to select folders and files on the SD card loaded in the IF-MTR32 (multitrack recorder) card installed in SLOT 1 or SLOT 2.

To open this screen, tap Menu Screen > Recorder/Player menu > Multi Track Recorder to open the MULTI TRACK RECORDER Screen. Then, tap the project/take name. This screen can also be opened by tapping the BROWSE button on the MULTI TRACK RECORDER - MENU Screen.

BROWSE MTR Screen showing project list

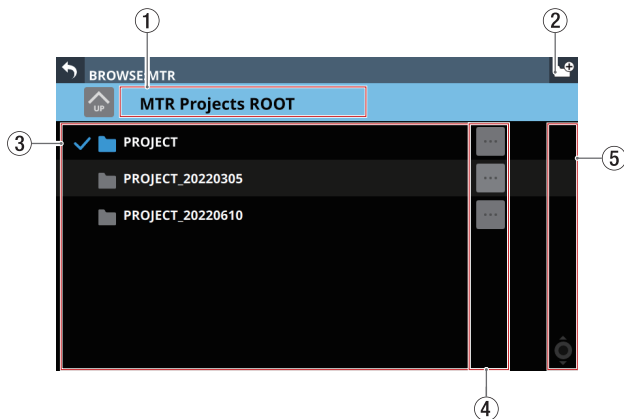

BROWSE MTR Screen showing take list

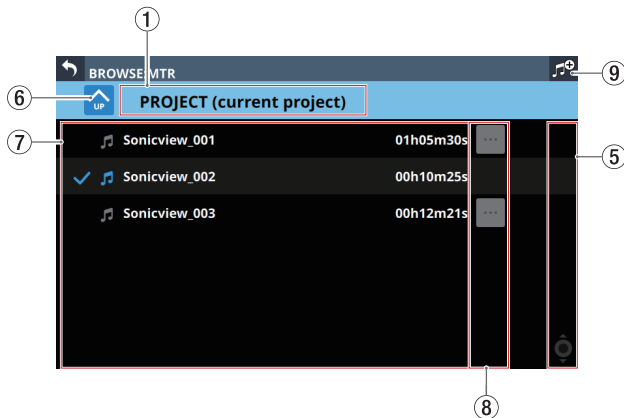

① Level name

- This shows the icon and name of the level that is currently open.
- “MTR Projects Root” will be shown when the project list is open.
- The name of the project that contains the takes will be shown when the take list is open. When the current project is being shown, “(current project)” will appear after the name.

② button

Use this button to create a new project folder at the root level of the SD card.

Tap this button to open a screen where the name of the folder being created can be input.



The combination of characters input can be changed depending on the status of the Caps lock and Shift keyboard buttons on the Make Project Screen.



See “Changing the keyboard keys” on page 167 for details about changing the keyboard.

③ Project list

- This shows the names of project folders on the root level of the SD card in name order.
- Tap a project in this area to select it as the current project.
- A check (✓) is shown next to the name of the current project.

④ Project menu buttons (⋮)

Tap one of these buttons to open a menu window that enables the following operations on the project folder shown to the left.

| Menu item | Explanation |
|-----------|--|
| Open | This selects the project folder to the left of the tapped  button as the current project and opens its take list. |
| Rename | This opens a screen where the name of the project folder to the left of the tapped  button can be changed. |
| Delete | This deletes the project folder to the left of the tapped  button. |

NOTE

- This operation is not possible during recording and playback.
- Rename and Delete cannot be used with the current project.

⑤ Scrollbar

This appears when the number of folders and files exceeds the amount that can be shown on the display at the same time.

Drag the scrollbar to scroll the screen. The project/take list can also be scrolled by swiping it up and down as well as by turning LCD knob 8.

12 – Multitrack Recorder

⑥ Level change button

Tap the  button to show the folder level one step above the current level.

NOTE

This will be gray when the MTR Projects Root (highest) level is open.

⑦ Take list

This shows the names and lengths of the takes in the project folder that is currently being shown. Tap this area to select a take as the current take, adding a check mark (✓) to it.

⑧ Take menu buttons (☰)

Tap one of these buttons to open a menu window that enables the following operations on the take shown to the left.

| Menu item | Explanation |
|-----------|---|
| Open | This selects the take to the left of the tapped ☰ button and reopens the MULTI TRACK RECORDER Screen. |
| Rename | This opens a screen where the name of the take to the left of the ☰ button can be changed. |
| Delete | This deletes the take to the left of the ☰ button. |

NOTE

This operation is not possible during recording and playback.

⑨ New take creation button (OVERDUB MODE only)

Use this button to create a new take.

Tap this button to open the following confirmation message.

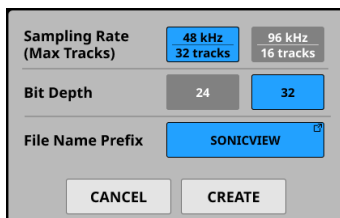

Set the Sampling Rate, Bit Depth and File Name Prefix, and tap the CREATE button to create a take.

Folder structure overview

The IF-MTR32 manages audio files in project folders. The SD card contains "PROJECT" and other project folders. These project folders contain audio files called takes (files from single recordings).

Folder structure

The illustration below shows the folder structure. The folder and file structure can be checked by accessing the SD card using a computer with an SD card reader.

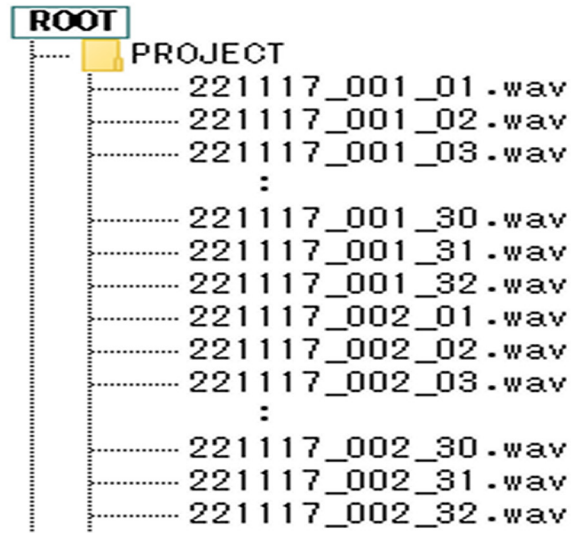

NOTE

- Other folders and files will also be created for management.
- Only folders at the root of the SD card can be selected as the current folder. Folders in other locations cannot be selected as the current folder.

Recording file names

The naming pattern for recording files is as follows.

[1–9-character File Name Prefix]_[3-digit take number]_[2-digit track number].wav

File format overview

The IF-MTR32 can record and play files with the following formats.

- File format: BWF/WAV*
- Sampling frequency: 48 kHz, 96 kHz
- Quantization bit depth: 16-bit**, 24-bit, 32-bit
- Number of channels: 1 (mono)

* This unit does not record files in WAV format, but it can play them.

** Recording with a quantization bit depth of 16-bit is not possible. Moreover, punching in/out is not possible with takes that contain 16-bit tracks. For this reason, selecting takes that contain 16-bit tracks is not possible when the MTR operation modes is OVERDUB MODE.

NOTE

- The single-channel WAV files named "[File Name Prefix]_[2-digit track number].wav" and numbered 32 and below when the sampling frequency is 48 kHz (16 and below when the sampling frequency is 96 kHz) are recognized as a single take.
- Single-digit track numbers have "0" placed at the number beginnings, for example "01" and "02".
- WAV files with the following "[2-digit track number]" values in their names are recognized as individual takes.
 - 48kHz sampling frequency: 33 and higher
 - 96kHz sampling frequency: 17 and higher
- WAV files without "[2-digit track number]" values in their names are recognized as individual takes.

Managing projects

With the IF-MTR32 (multi track recording) card, groups of files recorded at the same time are called “takes”. The folders that contain recorded takes are handled as “projects” and data is managed separately for each project folder.

To record and produce music, a project folder that has already been created must be selected or a new project folder must be created.

This chapter describes functions that range from basic operations such as procedures for selecting and creating new projects to various project management functions.

NOTE

To use the WAV files from a project in a DAW or other application, copy them to a computer. Do not use the files on the SD card directly.

Viewing project and take lists

To open a list of projects/takes saved on the SD card, tap the project or take name area on the MULTI TRACK RECORDER screen to open the BROWSE MTR Screen. The BROWSE MTR screen can also be opened by tapping the BROWSE button on the MULTI TRACK RECORDER – MENU Screen. (See “MULTI TRACK RECORDER - BROWSE Screen” on page 229.)

Project operations

Tap the  button at the right end of a project folder name on the BROWSE MTR Screen to open a menu window where project operations can be conducted.

Tap the buttons in the menu window to conduct project operations.

| Menu item | Explanation |
|-----------|---|
| Open | Tapping this selects that project as the current project and opens its take list. |
| Rename | Tapping this opens the Rename screen where the name of the selected project can be changed. |
| Delete | Tap this to open a message confirming whether or not to delete the selected project. <ul style="list-style-type: none"> • Tap the CANCEL button to close the confirmation message. • Tapping the OK button will delete the selected project and close the confirmation message. |

NOTE

- This operation is not possible during recording and playback.
- Rename and Delete cannot be used with the current project.

Creating new projects

To record or play with this unit, you must create and select a project.

The following procedure can be used to create a new project.

1. Open the BROWSE MTR Screen when the MTR is stopped. (See “MULTI TRACK RECORDER - BROWSE Screen” on page 229.)
2. Tap the  button at the top right of the screen to open the Make Project Screen where the name of the project being created can be input.



3. The combination of characters input can be changed depending on the status of the Caps lock and Shift keyboard buttons on the Make Project Screen. See “Changing the keyboard keys” on page 167 for details about changing the keyboard.

TIP

The project name can be changed later on the Rename Screen.

4. Tap the Enter button to create a new project and return to the MTR BROWSE Screen.

NOTE

- To cancel project creation, tap the  button at the top left of the screen.
- Input project names must be at least 1 character and no more than 11 characters.
- Project are created on the root level of the SD card.
- If a folder with the same name already exists when the Enter button is tapped, the following message will appear. Input a different name.

This name already exists. Please enter another name.

12 – Multitrack Recorder

Selecting projects

Follow the procedures below to select the project to use.

1. Open the BROWSE MTR Screen when the MTR is stopped. (See "MULTI TRACK RECORDER - BROWSE Screen" on page 229.)

NOTE

A check (✓) is shown next to the name of the project that is currently selected.

2. Tap the name of a project folder to select it as the current project, adding a check (✓) next to the name.

NOTE

The following selection procedures can also be used.

1. Tap the  button at the right end of a project folder name to open a menu window.
2. Tap the Open button to set the selected project as the current project and open its take list.

Deleting projects

Projects can be deleted.

Deleting unnecessary projects when the SD card space is low can create more open space.

NOTE

- The current project cannot be deleted.
- Files might be saved on the SD card for using the UNDO function in OVERDUB MODE. Those files can be deleted if the SD card loaded in the IF-MTR32 is removed and reinserted.

1. Open the BROWSE MTR Screen when the MTR is stopped. (See "MULTI TRACK RECORDER - BROWSE Screen" on page 229.)
2. Tap the  button at the right end of the folder name of the project that you want to delete to open a menu window.
3. Tap the Delete button to open a message confirming whether or not to delete the selected project.
 - Tap the CANCEL button to close the confirmation message.
 - Tapping the OK button will delete the selected project and close the confirmation message.

Changing project names

1. Open the BROWSE MTR Screen when the MTR is stopped. (See "MULTI TRACK RECORDER - BROWSE Screen" on page 229.)
2. Tap the  button at the right end of the folder name of the project that you want to rename to open a menu window.
3. Tap the Rename button to open the Rename Screen where the name of the selected project can be changed.



4. Change the project name. The combination of characters input can be changed depending on the status of the Caps lock and Shift keyboard buttons on the Rename Screen. See "Changing the keyboard keys" on page 167 for details about changing the keyboard.
5. Tap the Enter button to change the project name and return to the MTR BROWSE Screen.

NOTE

- To cancel project renaming, tap the  button at the top left of the screen.
- Changed project names must be at least 1 character and no more than 11 characters.
- The name of the current project cannot be changed.
- If a folder with the same name already exists when the Enter button is tapped, the following message will appear. Input a different name.

This name already exists. Please enter another name.

Basic recording

Selecting the MTR input source

The input source can be selected for the IF-MTR32 (multitrack recording) card.

MTR and automatic routing

Tap the AUTO ROUTING (Ⓜ) button at the top of the MULTI TRACK RECORDER Screen to open the following routing confirmation message.

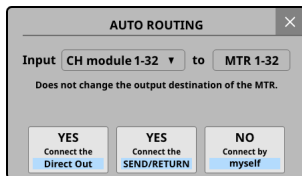

- After selecting either “CH module 1-32” or “CH module 9-40”, tap the “YES Connect the Direct Out” button to route the DIRECT OUT connections of the selected CH module group to 1–32 of the slot in which the IF-MTR32 is installed.
- Tap the “YES Connect the SEND/RETURN” button to route the INSERT SEND/RETURN connections of the selected CH module group to 1–32 of the slot in which the IF-MTR32 is installed.
- Tapping the “NO Connect by myself” button will keep the current routing settings, so make necessary routing changes manually.

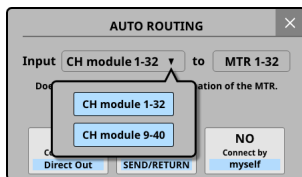

- Tap the [X] button to close the message. Doing this will retain the current routing settings.

Manual input routing to the MTR

Audio signals can be input to the MTR by assigning the desired signals to the output ports of the SLOT that the IF-MTR32 is installed in.

- To send the audio signal of a CH module to the MTR, select “1-32” of the slot in which the IF-MTR32 is installed for the following assignment destinations.
 - DIRECT OUT (DIRECT OUT button on)
 - Insert Send

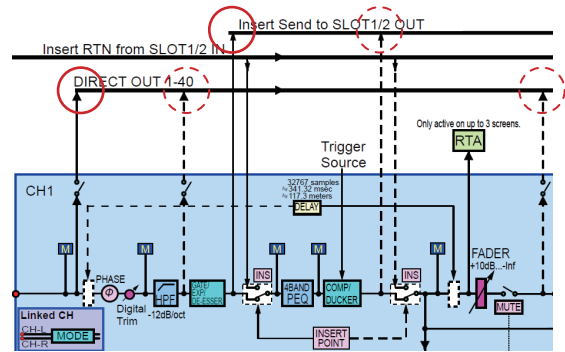

- To send the audio signal of a BUS module to the MTR, select “1-32” of the slot in which the IF-MTR32 is installed for the following assignment destinations.
 - Insert Send
 - Output Port

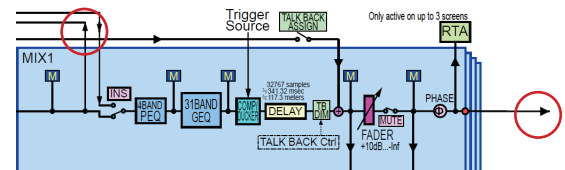

NOTE

Input port audio signals cannot be sent to the MTR without assigning them to a CH module.

12 – Multitrack Recorder

Precautions

- When recording the DIRECT OUT if the DIRECT OUT POINT setting is "POST HPF":
Use caution because signals will pass through Phase/D. Trim/HPF again during sound check (playback) if Phase/D. Trim/HPF is enabled during recording.
- When recording the DIRECT OUT if the DIRECT OUT POINT setting is "POST FADER":
Use caution because signals will pass through Phase, D.Trim, HPF, GATE, EQ, COMP and DELAY again during sound check (playback) if they are enabled during recording.

How to avoid these issues

To avoid two routes for processing the signals when recording and when playing back with the CH module, set the routing from the CH module to the MTR to one of the following.

- DIRECT OUT with DIRECT OUT POINT setting set to "INPUT"
- Insert Send

Precaution

When recording the BUS Output Port:

Use caution because signals will pass through EQ/GEQ/COMP/DELAY/Phase again during sound check (playback) if EQ/GEQ/COMP/DELAY/Phase is enabled when recording the BUS Output Port.

How to avoid this issue

To avoid two routes for processing the signals when recording and when playing back with the BUS module, set the routing from the BUS module to the MTR to "Insert Send".

Recording

This unit can simultaneously record up to 32 tracks. The following recording procedures are an example of steps to take when recording with the IF-MTR32 for the first time.

1. Load an SD card in the IF-MTR32.
2. Use the Erase Format function on the MULTI TRACK RECORDER - MENU Screen to format the SD card. (See "⑥ Format buttons" on page 228.)
3. Tap the MTR operation mode button at the top of the MULTI TRACK RECORDER Screen (See "④ MTR operation mode button" on page 217.), and select LIVE RECORDING MODE or VIRTUAL SOUND CHECK MODE.
4. Set REC READY to "On" for the tracks to record. Recording standby will be enabled, and the REC READY indicators will blink red.
5. Adjust the input levels of each channel that will be recorded.
6. Tap the ● button on the MULTI TRACK RECORDER Screen to pause recording.
7. Tapping the ► button on the MULTI TRACK RECORDER Screen will start recording and make the ● and ► buttons appear lit.
The REC READY indicators for tracks being recorded will stop blinking and stay lit.
8. When recording has completed, tap the ■ button.

Checking recorded audio (playing recordings)

1. Switch to MTR routing for playback.
Tap the SOUND CHECK button on the MULTI TRACK RECORDER Screen and confirm the message that is shown (See "⑳ SOUND CHECK button" on page 219.). This highlights the button and routes the MTR outputs to the recording channel inputs and Insert Return, enabling playback monitoring.
See "⑳ SOUND CHECK button" on page 219 for details switching MTR routing.

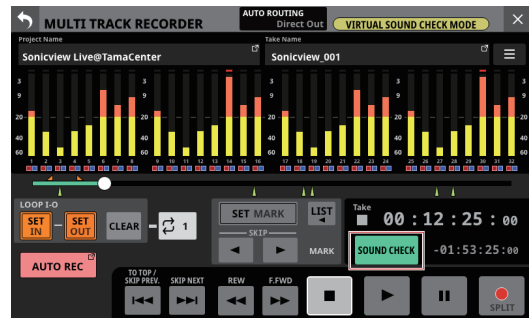

2. Use the ◀▶ and ■ buttons on the MULTI TRACK RECORDER Screen, for example, to locate to a position you want to check.

NOTE

For details about the locate function, see "Locate function" on page 235.

3. Tap the ► button on the MULTI TRACK RECORDER Screen to play the recorded tracks.

NOTE

To replace parts of tracks, switch the MTR operation mode to OVERDUB MODE and punch in/out. (See "Punch in/out function" on page 237 and "Automatic punch in/out function" on page 237.)

Recorder functions

Locate function

The playback position can be moved on the MULTI TRACK RECORDER Screen in the following ways.

All these methods can be used when the recorder is stopped or playing back.

- Drag the progress bar left or right
This allows approximate changes to the location to be made quickly.
- Turn LCD knob 8 (lit green) when the MULTI TRACK RECORDER Screen is open
Each click of LCD knob 8 changes the playback position by 50–70 ms. Each click of LCD knob 8 while it is being pressed changes the playback position by about 10 sec.
- Touch and hold the ◀◀ or ▶▶ button
- Input the location time

Inputting the location time to locate

The current position of the recorder can be moved by inputting the time in the time counter.

1. Tap the elapsed time counter on the MULTI TRACK RECORDER Screen to switch to location time input mode and show number input and LOCATE buttons below the time counter.

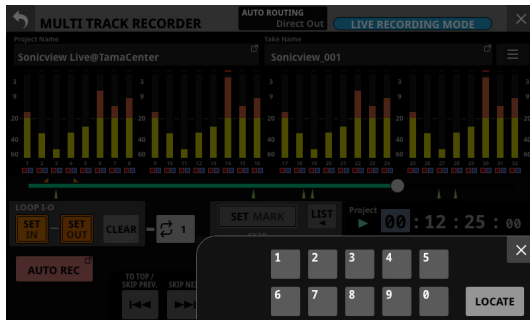

2. Input the desired location time.
3. Tap the LOCATE button to locate (move) immediately to the input time.

Repeat playback function

The repeat playback function can be used to play something over and over.

Tap the repeat mode setting button on the MULTI TRACK RECORDER Screen to set the repeat playback function.

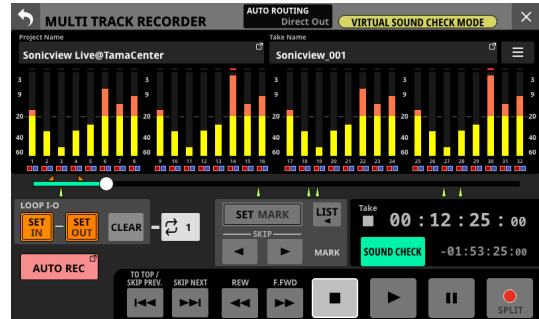

- When the MTR operation mode is LIVE RECORDING MODE or VIRTUAL SOUND CHECK MODE, tap the repeat mode setting button to cycle through these options: OFF, 1, ALL and I-O.
- When the MTR operation mode is OVERDUB MODE, tap the repeat mode setting button to cycle through these options: OFF, 1, and I-O. Repeat playback is not possible, however, when the AUTO PUNCH setting is "ON".

| Repeat mode | Function |
|-------------|---|
| | Playback will not be repeated. |
| | The entire take that is currently selected will be played repeatedly. |
| | The entire project will be played repeatedly. This can be selected when the MTR operation mode is LIVE RECORDING MODE or VIRTUAL SOUND CHECK MODE. |
| | Playback will be repeated between the IN and OUT points. (See "Setting the punch in/out points" on page 237.) |

NOTE

If the MTR operation mode is switched to OVERDUB MODE when the repeat mode is set to ALL, the repeat mode will be automatically switched to OFF.

12 – Multitrack Recorder

Automatic recording function

This function can start recording automatically. Recording starts automatically when the recording level exceeds a set level. In addition, the recorder can be set to pause the current file or start a new file when the recording level goes below a set level. Make these settings on the MULTI TRACK RECORDER- MENU Screen.

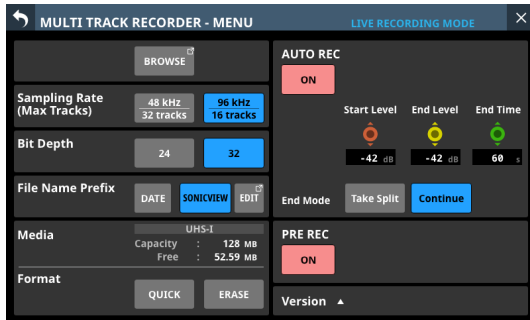

NOTE

This can be used when the MTR operation mode is LIVE RECORDING MODE or VIRTUAL SOUND CHECK MODE.

AUTO REC button

Tap this button to turn the automatic recording function on/off (default). When On, this button will appear red and recording will occur according to the following settings.

Start Level knob

This sets the level for starting automatic recording. Use LCD knob 6, which is lit red, to set this.

Options: OFF*, -72 dBFS – -24 dBFS (in 6dBFS increments, -42 dBFS default)

* When "OFF" is selected, tap the ● button on the MULTI TRACK RECORDER Screen to start recording.

End Level knob

This sets the level for ending automatic recording. Use LCD knob 7, which is lit yellow, to adjust it.

Options: OFF*, -72 dBFS – -24 dBFS (in 6dBFS increments, -42 dBFS default)

* When "OFF" is selected, tap the ■ button on the MULTI TRACK RECORDER Screen to stop recording.

End Time knob

This sets the time until automatic recording stops after the recording level goes below the end level. Use LCD knob 8, which is lit green, to adjust it. If the recording level goes above the End Level before this time elapses, recording will continue.

Range: 1 – 60 seconds (default: 5 seconds)

End Mode buttons

Tap one of these buttons to set what happens when automatic recording has started and the End Time has elapsed after the recording level has gone below the End Level.

| Option | Meaning |
|----------------------|--|
| Take Split (default) | Standby for recording in a new take |
| Continue | Standby for recording in the same take |

The selected button will be highlighted light blue.

Pre-recording function

When recording is paused, this function can record up to two seconds of signal input before recording is started. Make these settings on the MULTI TRACK RECORDER- MENU Screen.

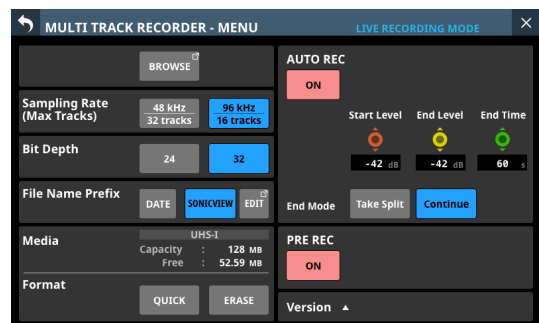

NOTE

This can be used when the MTR operation mode is LIVE RECORDING MODE or VIRTUAL SOUND CHECK MODE.

PRE REC button

Tap this button to turn the pre-recording function on/off (default: OFF). When on, this button will appear red.

Punch in/out function

Punching in and out is a function used to replace parts of already recorded tracks.

After starting playback of the recorder, use this to switch to recording when it reaches the part to be replaced (punch in). Then, switch back to playback when the end of that part is reached (punch out) and stop after the set amount of time.

NOTE

- This can only be used when the MTR operation mode is OVERDUB MODE.
- When the MTR operation mode is OVERDUB MODE, always use Insert Send/Return for mixer and MTR routing. Normal punch in/out recording will not be possible using different routing settings.

1. Determine the part you want to replace in advance. Select a point where the replacement audio can be combined well with the original track audio.
2. Turn on REC READY for the track with the part to be replaced and enter recording standby (REC READY indicator blinks red).
3. Start playback before the part to be replaced.
4. When the part to be replaced is reached, tap the ● button on the MULTI TRACK RECORDER Screen, and perform the part. Recording will start (punch in).
5. When the end of the part to be replaced is reached, tap the ■ or ► button on the MULTI TRACK RECORDER Screen.
 - Tap the ■ button to stop recording.
 - Tap the ► button to switch from recording to playback.

Using the footswitch to punch in/out

A footswitch can be used to punch in/out if the recommended TASCAM RC-1F footswitch (sold separately) is connected to the FOOTSWITCH jack on the rear panel.

To use a footswitch to punch in/out, you must set the foot switch function assignment to "Punch IN/OUT" for "MTR" in advance. (See "Foot Switch page" on page 53.)

At step 4 above, press the footswitch instead of the ● button, and at step 5 press it again instead of the ► button.

NOTE

This unit was designed to be used with unlatched (momentary) footswitches that have to be pushed to function (shorted when pushed).

Automatic punch in/out function

Using the automatic punch in/out function, you can automatically record between punch in and out points set in advance.

To use the automatic punch in/out functions, start playback from a pre-roll point before the punch in point where recording will start.

Recording will stop when the punch out point is reached, and playback will stop after the post roll.

NOTE

This can only be used when the MTR operation mode is OVERDUB MODE.

Setting the punch in/out points

1. Open the MULTI TRACK RECORDER Screen.

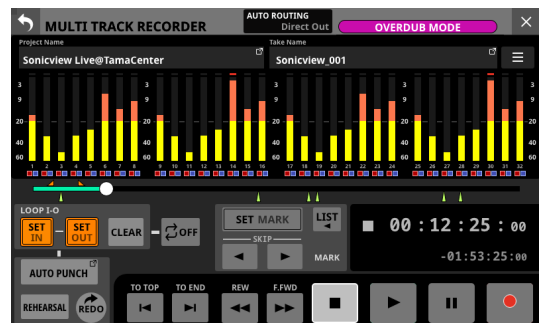

2. Tap the ► button to start playback.
3. Tap the SET IN button at the punch in point and the SET OUT button at the punch out point.
4. The set points are shown above the progress bar as ■ and ■.

NOTE

- Punch in/out points can also be set when stopped.
- Set the in and out points at least 200 ms apart. If the interval is less than 200 ms, the following message will appear and the later point will not be set.

Invalid I/O. Interval too short.

- Trying to set the out point before the in point or the in point after the out point will fail and the following message will appear. Set the in point so that it is before the out point.

Invalid I/O. Please set IN and OUT in order.

- Tap the CLEAR button to clear set punch in and out points.
5. Press the ■ button to stop playback.
 6. Tap the AUTO PUNCH button to open the MULTI TRACK RECORDER - MENU Screen and turn on the automatic punch in/out function.

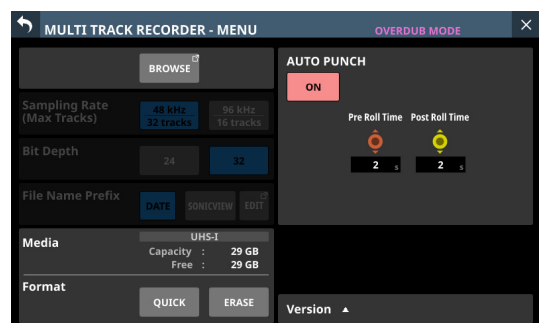

7. Tap the ◀ button at the top left of the screen to return to the MULTI TRACK RECORDER Screen.

NOTE

- By setting only the punch in point, you can start recording with automatic punch in and then continue recording until you tap the ■ or ► button to stop.
- By setting only the punch out point, you can start recording by tapping the ● button and then stop recording with automatic punch out.

12 – Multitrack Recorder

Setting pre roll and post roll points

When using automatic punch in/out, set the amount of playback time before the punch in point (pre roll point) and the amount after the punch out point before playback stops (post-roll point).

1. Open the MULTI TRACK RECORDER - MENU Screen when the MTR is stopped. (See “MULTI TRACK RECORDER - MENU Screen” on page 227.)

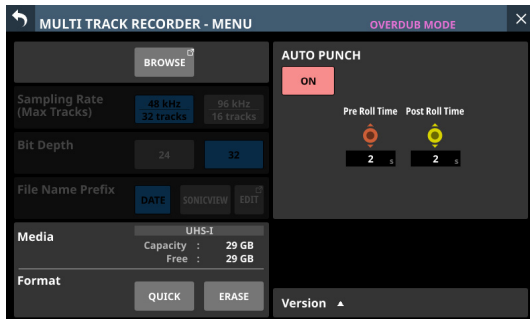

2. Use LCD knob 6, which is lit red, to adjust the Pre Roll Time, and use LCD knob 7, which is lit yellow, to adjust the Post Roll Time.
Pre Roll Time: 0 – 10 seconds (default: 2 seconds)
Post Roll Time: 0 – 10 seconds (default: 2 seconds)
3. Tap the button at the top left of the screen to return to the MULTI TRACK RECORDER Screen.

Rehearsing punching in and out

You can rehearse before punch in/out recording. In rehearsal, recording will not occur, but monitoring will be the same as if recording.

1. Confirm that the AUTO PUNCH button appears red on the MULTI TRACK RECORDER Screen.
2. Tap the REHEARSAL button on the MULTI TRACK RECORDER Screen to turn it on, highlighting it.
3. Turn on REC READY for the tracks to use with automatic punch in/out. (See “REC READY/INPUT MONITOR settings” on page 225.)
4. Tap the button.
Auto punch in/out rehearsal starts.
 - The transport starts playback from the pre-roll point. Both track playback and input source signals can be monitored. (See “Setting pre roll and post roll points” on page 238.)
 - When the punch in point is reached, only the input source signal will be monitored. The button will blink, showing that it rehearsal mode is active.
 - When the punch out point is reached, both track playback and input source signals will be monitored. The button will become gray.
 - When the set Post Roll Time has elapsed after the punch out point, playback will automatically stop and the button will blink. (See “Setting pre roll and post roll points” on page 238.)
 - Rehearsal can be repeated.

Using automatic punching in and out

Follow these procedures to punch in and out automatically and record.

1. Confirm that the AUTO PUNCH button appears red on the MULTI TRACK RECORDER Screen.
2. Tap the REHEARSAL button on the MULTI TRACK RECORDER Screen to turn it off, making it appear gray.
3. Turn on REC READY for the tracks to use with automatic punch in/out. (See “REC READY/INPUT MONITOR settings” on page 225.)
4. Tap the button.
 - The transport starts playback from the pre-roll point. Both track playback and input source signals can be monitored. (See “Setting pre roll and post roll points” on page 238.)
 - When the punch in point is reached, only the input source signal will be monitored, and the button will appear lit.
 - When the punch out point is reached, both track playback and input source signals will be monitored. The button will become gray.
 - When the set Post Roll Time has elapsed after the punch out point, playback will automatically stop and the button will blink. (See “Setting pre roll and post roll points” on page 238.)

NOTE

- The following message will appear if the button is tapped when the AUTO PUNCH button is lit red but the punch in and out points have not been set.

Tap the button after setting the punch in and out points.

Cannot execute AUTO PUNCH. Set both I/O points.

- The following message will appear if the button is tapped during MTR playback when the AUTO PUNCH button is lit red. Tap the button after stopping the MTR.

Cannot execute AUTO PUNCH. Stop the MTR.

Undoing auto punch in/out operations (UNDO function)

If you want to redo punching in and out, the operation last conducted can be undone.

When a project is loaded or the unit is turned off, information about previous operations will be lost, so undoing and redoing them will no longer be possible.

NOTE

Files used for undoing are sometimes saved on the SD card. Those files can be deleted if the SD card loaded in the IF-MTR32 is removed and reinserted.

Undoing the most recent punch in/out operation

Tap the UNDO button on the MULTI TRACK RECORDER Screen to start undoing and open a message.

When undoing completes, the state before the previous operation will be restored and the message will close.

Redoing an undone operation

After undoing, tap the REDO button on the MULTI TRACK RECORDER Screen to start redoing and open a message.

When redoing completes, the state before undoing will be restored and the message will close.

Editing takes

Changing take names

1. Open the BROWSE MTR Screen when the MTR is stopped. (See “MULTI TRACK RECORDER - BROWSE Screen” on page 229.)
2. Tap the  button at the right of the take name that you want to rename to open a menu window.
3. Tap the Rename button to open the Rename Screen where the name of the selected take can be changed.



4. Change the take name. The combination of characters input can be changed depending on the status of the Caps lock and Shift keyboard buttons on the Rename Screen. See “Changing the keyboard keys” on page 167 for details about changing the keyboard.
5. Tap the Enter button to change the take name and return to the MTR BROWSE Screen.

NOTE

- Changed take names must be at least 1 character and no more than 16 characters.
- To cancel take renaming, tap the  button at the top left of the screen.
- If a take with the same name already exists in the same folder when the Enter button is tapped, the following message will appear. Input a different name.

This name already exists. Please enter another name.

12 – Multitrack Recorder

Deleting takes

Specified takes can be deleted.

Deleting unnecessary takes when the SD card space is low can create more open space.

NOTE

Files might be saved on the SD card for using the UNDO function in OVERDUB MODE. Those files can be deleted if the SD card loaded in the IF-MTR32 is removed and reinserted.

1. Open the BROWSE MTR Screen when the MTR is stopped. (See "MULTI TRACK RECORDER - BROWSE Screen" on page 229.)
2. Tap the  button at the right of the take that you want to delete to open a menu window.
3. Tap the DELETE button to open a message confirming whether or not to delete the selected take.
 - Tap the CANCEL button to close the confirmation message.
 - Tapping the OK button will delete the selected take and close the confirmation message.

Importing files that have been recorded on other devices

Audio files that meet the following conditions can be imported and played as takes. Moreover, files that were created on an IF-MTR32 (multitrack recording) card and meet the following conditions can be played as is.

- File format: BWF/WAV
- Sampling frequency: 48 kHz, 96 kHz
- Quantization bit depth: 16-bit, 24-bit, 32-bit
- Number of channels: 1

File name format

[File name first half]_[2-digit track number].wav

Examples:

SONICVIEW_001_01.wav (track 1 file)
SONICVIEW_001_02.wav (track 2 file)
:
SONICVIEW_001_31.wav (track 31 file)
SONICVIEW_001_32.wav (track 32 file)

ATTENTION

Punching in/out is not possible with takes that contain 16-bit tracks. For this reason, selecting takes that contain 16-bit tracks is not possible in OVERDUB MODE.

NOTE

- WAV files named "[File name first half]_[2-digit track number].wav" with 2-digit track numbers from "01" to "32" when the sampling frequency is 48 kHz ("01" to "16" when the sampling frequency is 96 kHz) are recognized as a single take.
- Single-digit track numbers have "0" placed at the number beginnings, for example "01" and "02".
- WAV files with the following "[2-digit track number]" values in their names are recognized as individual takes.
 - 48kHz sampling frequency: 33 and higher
 - 96kHz sampling frequency: 17 and higher
- WAV files without "[2-digit track number]" values in their names are recognized as individual takes.

Preparation before Importing

Always use an IF-MTR32 to format SD cards before using them with an IF-MTR32 for the first time. SD cards formatted by an IF-MTR32 are optimized for improved performance.

Operation of this unit might be affected when using an SD card that has been formatted by a computer or other device.

1. Use the IF-MTR32 to format the SD card. (See “⑥ Format buttons” on page 228.)

NOTE

When formatted by an IF-MTR32, a “PROJECT” folder will automatically be created at the root level.

2. Remove the formatted SD card and load it in an SD card reader connected to a computer.
3. When a card has been formatted by an IF-MTR32, the computer will recognize it as a drive named “IF-MTR32”.
4. Copy the audio files that you want to load to a folder on the “IF-MTR32”.
5. When finished copying, remove the SD card from the card reader and load it in the IF-MTR32.

Using imported files with this unit

- If audio files have been added to the current project, those that can be played will automatically be recognized as takes.
- When audio files have been added outside the current project, if the added folder is selected as the current project on the BROWSE MTR Screen, those files that can be played will automatically be recognized as takes.

Mark function

Marks can be used to cue for playback, for example.

In addition to use with this unit, mark information added to WAV files can be used with software, for example, that supports the BWF format.

Adding marks

When playing or recording, the SET button on the MULTI TRACK RECORDER Screen can be tapped to add a mark at the current point.

- When a mark is added, a pop-up showing the mark number appears on the display.
- ▲ icons appear below the playback progress bar at the positions where marks are set.
- Marks added during recording/playback will automatically be saved in the WAV file when recording/playback stops.
- Marks added when stopped will automatically be saved in the WAV file at the following times.
 - When playback is started and then stopped after they have been set
 - When switching to a different take

NOTE

Punch in/out points are types of marks, but they are different from marks set using the SET MARK button in the following ways.

- Marks set using the SET MARK button are saved in WAV files.
- Punch in/out points are not saved in WAV files and are discarded by the following operations.
 - Changing the MTR operation mode
 - Switching projects or takes
 - Starting recording when in LIVE RECORDING or VIRTUAL SOUND CHECK mode
 - Turning off the power for the unit

12 – Multitrack Recorder

Moving between marks

The following two methods are available.

Moving forward/backward one at a time

When stopped, paused or playing back, tap the ◀/▶ MARK SKIP button on the MULTI TRACK RECORDER Screen to move (skip) from the current location to the previous/next mark.



Moving by selecting from a list

1. When stopped, paused or playing back, tap the LIST button on the MULTI TRACK RECORDER Screen to open a window that shows mark list information.

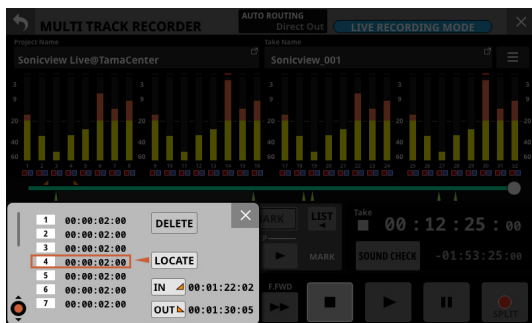

2. Turn LCD knob 1 to select the mark at the desired destination time.
3. Tap the LOCATE button to move (skip) to the position of the selected mark.

NOTE

Tap the IN or OUT point button in the mark list to move (skip) to the corresponding time.

Clearing individual marks

Marks can be cleared when stopped, paused or playing back. The following two methods are available.

Selecting from a list and deleting

1. When stopped, paused or playing back, tap the LIST button on the MULTI TRACK RECORDER Screen to open a window that shows mark list information.

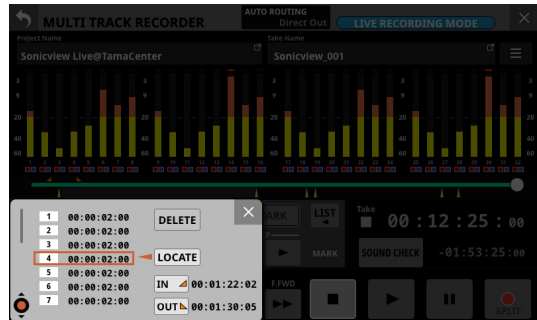

2. Turn LCD knob 1 to select the mark to be deleted.
3. Tap the DELETE button to delete that mark.

NOTE

Repeat steps 2 – 3 to delete multiple marks.

Moving to the mark and deleting

Move to the position of the mark to be deleted and tap the SET MARK button on the MULTI TRACK RECORDER Screen to delete that mark.

When a mark is deleted, a pop-up will appear on the display.

13 – List of shortcut operations

This unit has shortcuts that combine the simultaneous use of keys and the touchscreen, for example, to easily execute certain operations.

- Pressing something at the same time as the HOME key will reset that parameter to its standard value. (Brightness adjustment is excluded.)

| Shortcut operation | Explanation |
|---|--|
| Press a SEL key while pressing the HOME key on the top panel | <ul style="list-style-type: none"> • This sets the FADER level to 0 dB for the channel of the pressed SEL key on the top panel. • When the SENDS ON FADER key on the top panel is pressed (Sends On Fader mode is on), this sets the SEND level to 0 dB. |
| Tap the SEND level area on the touchscreen while pressing the HOME key on the top panel | This sets the following parameters to 0 dB. <ul style="list-style-type: none"> • Home Screen SEND levels • MODULE (OVERVIEW) Screen FADER levels • MODULE (SEND/PAN) Screen SEND levels • SEND OVERVIEW Screen SEND LEVEL (INPUT) page and SEND LEVEL (BUS) page SEND/MASTER levels • SEND OVERVIEW Screen FADER LEVEL page FADER and MASTER levels |
| Tap the PAN area on the touchscreen while pressing the HOME key on the top panel | This sets the following pan/balance settings to center (C). <ul style="list-style-type: none"> • Home Screen PAN/BAL • MODULE (OVERVIEW) Screen PAN/BAL • MODULE (SEND/PAN) Screen PAN/BAL • SEND OVERVIEW Screen SEND PAN (INPUT) page and SEND PAN (BUS) page PAN/BAL |
| Tap the EQ gain area on the touchscreen while pressing the HOME key on the top panel | This sets the EQ gain settings to 0 dB on the MODULE (EQ) Screens of each module. |
| Turn any LCD knob while pressing the HOME key on the top panel | This adjusts the brightness of all the touchscreens, channel screens, various indicators and the lamp connected to the LAMP connector on the rear panel at the same time. |
| Press and turn any LCD knob while pressing the HOME key on the top panel | This adjusts the brightness of all the touchscreens and channel screens at the same time. |

- While pressing the MENU key, press a key to open its settings screen. (Adjusting contrast is excluded.)

| Shortcut operation | Explanation | |
|--|---|---|
| Press the TALKBACK key while pressing the MENU key on the top panel | This opens the MONITOR SETUP Screen TALKBACK/OSCILLATOR page on the touchscreen. | |
| Press the SOLO or SOLO CLEAR key while pressing the MENU key on the top panel | This opens the MONITOR SETUP Screen MONITOR/SOLO page on the touchscreen. | |
| Press a LAYER KEY 1–7 while pressing the MENU key on the top panel | This opens the Layer Key SETUP Screen for the selected layer on the touchscreen. | |
| Press a USER KEY A–F or USER KEY 1–12 key while pressing the MENU key on the top panel | This will open one of the following screens that corresponds to the function assigned to USER KEY A–F or USER KEY 1–12. | |
| | USER key function Screen recalled by MENU+USER key | |
| | Unassigned | USER KEY setting screen for the depressed USER key |
| | Tap Tempo | FX MODULE (FX) Screen for the assigned number |
| | Mute Group | Mute Group Assign Screen |
| | Sends On Fader | Nothing will happen |
| | Snapshot | Snapshot List Screen |
| | Screen | Screen where Parameter 1 and 2 are set |
| | Talkback | MONITOR SETUP Screen TALKBACK/OSCILLATOR page |
| | Monitor Select | MONITOR SETUP Screen MONITOR/SOLO page |
| | Monitor Control | MONITOR SETUP Screen MONITOR/SOLO page |
| | Send On/Off | MODULE (SEND/ PAN) Screen for module where Parameter 1 is set |
| MTR | Multi Track Recorder Screen | |
| Turn an LCD knob while pressing the MENU key on the top panel | This adjusts the contrast of the channel screen that corresponds to that knob. | |

14 – Troubleshooting

If you are having trouble with the operation of this unit, please try the following before seeking repair.

If these measures do not solve the problem, please contact the store where you purchased this unit or TASCAM customer support service.

Power will not turn on

- Confirm that the power plug and other connectors are inserted completely.

No sound is output

- Confirm that the input and output routings and bus assignments are correct.
- Check connections with the monitoring system again. Check the volume of the amplifier as well.
- Confirm that the monitoring sources are correctly selected.
- Are that channel faders raised to suitable levels?
- Confirm that the MASTER fader is raised to a suitable level.
- Confirm that the headphones or MONITOR OUT volume is raised to a suitable level.
- Are any of the channel MUTE (③) or SOLO (④) keys on?

There is noise

- Confirm that the connection cables do not have connection issues.

Changed settings are forgotten

This unit saves settings at one-minute intervals.

Since saving could fail depending on when the power is turned off, use the Save Current Settings item on the Menu Screen to save the current settings in the internal memory before turning the power off.

Touchscreen operations are not possible

- If the system detects that touchscreen operations have stopped working, the following message will appear on the channel screens.

On Sonicview 16

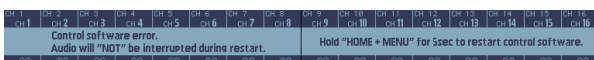

On Sonicview 24



Follow the instructions in the message, and press and hold the HOME and MENU keys for at least five seconds to restart the system and enable touchscreen operation.

Audio will continue to be output without interruption, but fader and mute operations will not be possible while restarting.

Since restarting will take some time to complete, conduct it when it will not cause trouble.

Fader, key and LCD knob operations are not possible

- If the system detects that fader, key and LCD knob operations have stopped working, the following message will appear on the touchscreen.

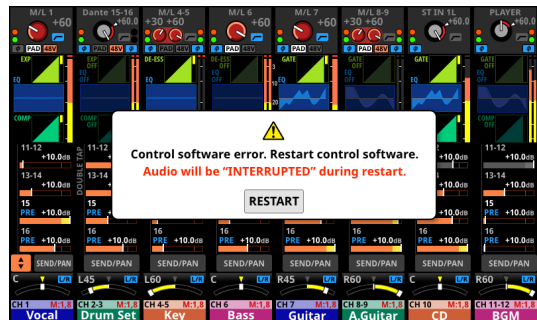

Tap the RESTART buttons to open a restart confirmation window.

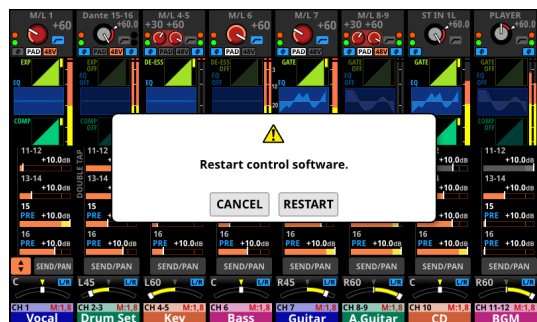

Tap the RESTART button on the confirmation screen to restart the system and enable fader, key and LCD knob operations. Note that while restarting audio output will stop. Since restarting will take some time to complete, conduct it when it will not cause trouble.

14 – Troubleshooting

Parameters on the touchscreen can be operated but do not affect the sound

- Trouble might have occurred with the signal processing device. If the system detects trouble with the signal processing control device, the following message will appear on the touchscreen and the channel screen.

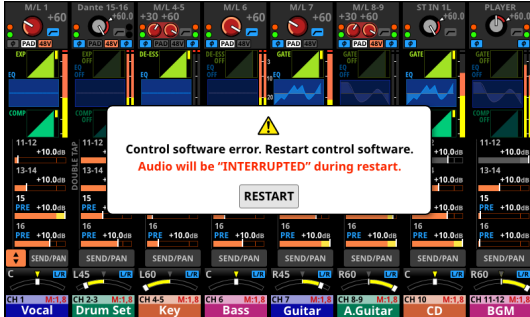

On Sonicview 16

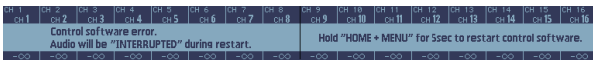

On Sonicview 24

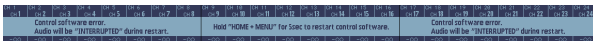

Tap the RESTART buttons to open a restart confirmation window.

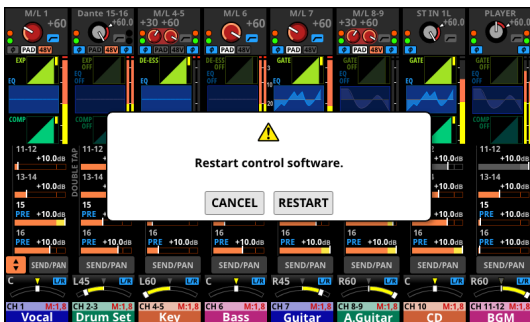

Tap the RESTART button on the confirmation screen to restart the system and enable proper LCD knob operations. Alternatively, follow the instructions in the message on the Channel Screen, and press and hold the HOME and MENU keys for at least five seconds to restart the system. Note that while restarting audio output will stop. Since restarting will take some time to complete, conduct it when it will not cause trouble.

15 – Specifications and ratings

Internal processing

Simultaneous processing capabilities

- Inputs: 52
 - Mono: 40
 - Stereo: 2 pairs
 - FX Return: 4 pairs
- Buses: 32
 - MIX buses (AUX/GROUP switchable): 22
 - MAIN L/R bus: 1 stereo
 - FX SEND buses: 4 pairs
- Internal FX: 4

Input ports

96 kHz: 160 ports maximum (Sonicview 24),
152 ports maximum (Sonicview 16)

48 kHz: 256 ports maximum (Sonicview 24),
248 ports maximum (Sonicview 16)

- MIC/LINE: 24 (Sonicview 24), 16 (Sonicview 16)
- ST IN (RCA): 4 (2 stereo)
- Dante: 32 (96 kHz), 64 (48 kHz)
- SLOT: 32 × 2 slots (96 kHz), 64 × 2 slots (48 kHz)
- USB AUDIO: 32
- Internal player: 2 (1 stereo)
- OSC: 1
- TALKBACK: 1

Output ports

96 kHz: 148 ports maximum

48 kHz: 244 ports maximum

- OUTPUT (analog): 16
- Dante: 32 (96 kHz), 64 (48 kHz)
- SLOT: 32 × 2 slots (96 kHz), 64 × 2 slots (48 kHz)
- USB AUDIO: 32
- MONITOR OUT (analog): 2 (1 stereo)
- Internal recorder: 2 (1 stereo)

Input and output ports

- Analog insert I/O: 2
 - MIC/LINE inputs 15/16 (Sonicview 24)
 - MIC/LINE inputs 7/8 (Sonicview 16)

Signal processing

- Mixer engine: 96kHz/54-bit floating-point arithmetic
- ADC: 96 kHz/32-bit
- DAC: 96 kHz/24-bit
- Digital I/O sampling frequencies: 96 kHz, 48 kHz

Signal Delay

| 48 kHz | ms | Routing details |
|--------|-------|---|
| A to A | 0.510 | MIC/LINE IN → CH module → MAIN L/R BUS → MAIN L/R module → OUTPUT (analog) |
| A to A | 0.620 | MIC/LINE IN → CH module → MAIN L/R BUS → MAIN L/R module → MONITOR OUT |
| D to D | 0.498 | SLOT MADI IN → CH module → MAIN L/R BUS → MAIN L/R module → SLOT MADI OUT |
| A to D | 0.458 | MIC/LINE IN → CH module → MAIN L/R BUS → MAIN L/R module → SLOT MADI OUT |
| D to A | 0.571 | SLOT MADI IN → CH module → MAIN L/R BUS → MAIN L/R module → OUTPUT (analog) |
| D to A | 0.666 | SLOT MADI IN → CH module → MAIN L/R BUS → MAIN L/R module → MONITOR OUT |

| 96 kHz | ms | Routing details |
|--------|-------|---|
| A to A | 0.510 | MIC/LINE IN → CH module → MAIN L/R BUS → MAIN L/R module → OUTPUT (analog) |
| A to A | 0.620 | MIC/LINE IN → CH module → MAIN L/R BUS → MAIN L/R module → MONITOR OUT |
| D to D | 0.104 | SLOT MADI IN → CH module → MAIN L/R BUS → MAIN L/R module → SLOT MADI OUT |
| A to D | 0.261 | MIC/LINE IN → CH module → MAIN L/R BUS → MAIN L/R module → SLOT MADI OUT |
| D to A | 0.374 | SLOT MADI IN → CH module → MAIN L/R BUS → MAIN L/R module → OUTPUT (analog) |
| D to A | 0.468 | SLOT MADI IN → CH module → MAIN L/R BUS → MAIN L/R module → MONITOR OUT |

15 – Specifications and ratings

Audio performance

0 dBu = 0.775 Vrms

Mic amp EIN (equivalent input noise)

-128 dBu or less

Frequency response

MIC/LINE IN to OUTPUT (Analog)
20 Hz - 40 kHz: +0 dB, -1.0 dB (JEITA)

Dynamic range

108 dB or more (MIC/LINE IN to OUTPUT (Analog), PAD = OFF, TRIM at minimum, D.Ref = -20dBFS, Clock master = INT, JEITA)

110 dB or more (MIC/LINE IN to DANTE OUT, PAD = OFF, TRIM at minimum, JEITA)

112 dB or more (DANTE IN to OUTPUT (Analog), Clock master = INT, JEITA)

Distortion

0.002% or less (MIC/LINE IN to OUTPUT (Analog), Input at +4 dBu, PAD = OFF, TRIM at minimum, JEITA)

0.002% or less (MIC/LINE IN to DANTE OUT, Input at +4 dBu, PAD = OFF, TRIM at minimum, JEITA)

0.002% or less (DANTE IN to OUTPUT (Analog), Input at 0 dBFS, JEITA)

Crosstalk

100 dB or more (MIC/LINE IN to OUTPUT (Analog), 1 kHz sine wave, JEITA)

D.Ref: Digital Reference Level setting

Analog audio input and output ratings

0 dBu = 0.775 Vrms, 0 dBV = 1 Vrms

MIC/LINE input jacks

Sonicview 16: 1-16

Sonicview 24: 1-24

Connectors: XLR-3-31 equivalent (1: GND, 2: HOT, 3: COLD)

Input levels:

Pad off

Maximum input level: +12 dBu (TRIM at minimum)

Minimum input level: -62 dBu (TRIM at maximum)

Pad on

Maximum input level: +32 dBu (TRIM at minimum)

Minimum input level: -42 dBu (TRIM at maximum)

Input impedance: 5.0 kΩ or higher

NOTE

+48V phantom power can be supplied to each MIC/ LINE input jack separately.

LINE IN (BAL) jacks

Sonicview 16: 9-16

Sonicview 24: 17-24

Connectors: 6.3mm (1/4") TRS phone jacks (Tip: HOT, Ring: COLD, Sleeve: GND)

Input levels:

Pad off

Maximum input level: +12 dBu (TRIM at minimum)

Minimum input level: -62 dBu (TRIM at maximum)

Pad on

Maximum input level: +32 dBu (TRIM at minimum)

Minimum input level: -42 dBu (TRIM at maximum)

Input impedance: 5.0 kΩ or higher

INSERT jacks

Sonicview 16: 7-8

Sonicview 24: 15-16

Connectors: 6.3mm (1/4") TRS phone jacks (Tip: SEND, Ring: RETURN, Sleeve: GND)

RETURN (Ring)

Maximum input level: +18 dBu

Nominal input level: -2 dBu

Input impedance: 5 kΩ or more

SEND (Tip)

Maximum output level: +18 dBu

Nominal output level: -2 dBu

Output impedance: 100 Ω or less

TALKBACK input jack

Connectors: XLR-3-31 equivalent (1: GND, 2: HOT, 3: COLD)

Maximum input level: +10 dBu

Minimum input level: -65 dBu

Gain adjustment range: 0 – 55 dB

Input impedance: 5.0 kΩ or more

NOTE

+48V phantom power can be supplied.

ST IN 1–2 L/R jacks

Connectors: RCA pin jacks

Maximum input level: +6 dBV

Nominal input level: -10 dBV

Headroom: 16 dB

Input impedance: 10 kΩ or higher

OUTPUT 1-16 jacks

Connectors: XLR-3-32 equivalent (1: GND, 2: HOT, 3: COLD)

Output impedance: 100 Ω or less

Nominal output level:

+6 dBu (D.Ref: -9 dBFS, A.Ref: +6 dBu)

+4 dBu (D.Ref: -14/-16/-18/-20 dBFS, A.Ref: +4 dBu)

0 dBu (D.Ref: -18/-20 dBFS, A.Ref: 0 dBu)

Maximum output level:

+15 dBu (D.Ref: -9 dBFS, A.Ref: +6 dBu)

+18 dBu (D.Ref: -18 dBFS, A.Ref: 0 dBu)

+20 dBu (D.Ref: -20 dBFS, A.Ref: 0 dBu)

+18 dBu (D.Ref: -14 dBFS, A.Ref: +4 dBu)

+20 dBu (D.Ref: -16 dBFS, A.Ref: +4 dBu)

+22 dBu (D.Ref: -18 dBFS, A.Ref: +4 dBu)

+24 dBu (D.Ref: -20 dBFS, A.Ref: +4 dBu)

D.Ref: Digital Reference Level setting

A.Ref: Analog Reference Level setting

MONITOR OUT L/R jacks

Connectors: XLR-3-32 equivalent (1: GND, 2: HOT, 3: COLD)
Maximum output level: +24 dBu
Nominal output level: +4 dBu
Output impedance: 100 Ω or less

Phones jack

Connectors: 6.3mm (1/4") stereo phone jack, 3.5mm (1/8") stereo mini jack
Maximum output: 100 mW + 100 mW (32 Ω load, when connected to only one jack)

Digital audio input/output ratings

Dante PRIMARY/SECONDARY connectors

Connector: etherCON Cat5e compatible connector*
Transmission protocol: Dante
Gigabit Ethernet standard: 1000BASE-T (IEEE 802.3ab)
Cables: category 5e or faster STP cables
* etherCON is a registered trademark of Neutrik AG.

USB Audio

Sampling Rate: 48 kHz, 96 kHz
Bit Depth: 32 bit
Number of inputs: 32 channels (Input to this unit)
Number of outputs: 32 channels (Output from this unit)

Control input/output ratings

FOOTSWITCH jack

Connector: 6.3mm (1/4") TS phone jacks (Tip: HOT, Sleeve: GND)

ETHERNET connector

Connector: RJ-45
Compatible standards: 100BASE-TX, 1000BASE-T

GPIO connector

Connector: 25-pin D-sub (8-in/8-out, female, inch-standard)
• See "GPIO connector overview" on page 15 for details about the GPIO connector and assignments.

Other input and output specifications

USB port (Top panel)

Connector: USB Type-C
Protocol: USB 2.0 HIGH SPEED (480 Mbps)

USB port (Rear panel)

Connector: USB Type-B
Protocol: USB 2.0 HIGH SPEED (480 Mbps)

LAMP jack

Connector: XLR 4-pin female (pin 4: +12V, pin 3: GND)
Power supply voltage: 0 V – +12 V
Maximum output: 5 W

WORD IN connector

Connector: BNC
Input level: 0.5–5 V_{p-p}
Input impedance: 75 Ω \pm 10% (termination resistance on)*
Input frequency: 48, 96 kHz
Allowable frequency deviation: \pm 100 ppm

* See "④ WORD OUT Mode button" in "SYNC CLOCK screen" on page 34 for details about turning termination resistance on/off.

WORD THRU/OUT connector

Connector: BNC
Output level: equivalent to 5V TTL
Output frequency: 48, 96 kHz

• See "④ WORD OUT Mode button" in "SYNC CLOCK screen" on page 34 for details about through/word output switching.

Recorder specifications

Recording media

SDHC cards (8GB–32GB, Class 10 or more)
SDXC cards (64GB–128GB, Class 10 or more)
USB flash drives (8GB–128GB, playback only)

NOTE

A list of SD cards that have been confirmed for use with this unit can be found on our web site. Access this list from the product page of this product on the TEAC Global Site (<https://teac-global.com>) or contact the TASCAM customer support service.

File System

SDHC card: FAT32
SDXC card: exFAT
USB flash drives: FAT32/exFAT

Recording/playback formats

BWF/WAV
Recording: 48/96 kHz, 24-bit, 2-channel
Playback: 48/96 kHz, 16/24-bit, 2-channel
MP3
Playback: 44.1/48 kHz, 32–320 kbps, 2-channel
AAC
Playback: 44.1/48 kHz, 64–320 kbps, 2-channel

15 – Specifications and ratings

Operating system and computer requirements

Check the TEAC Global Site (<https://teac-global.com/>) for the latest information about supported operating systems.

ATTENTION

Operation with each OS was confirmed with standard system setups that met the following conditions. Operation is not guaranteed, however, with all systems that meet the following conditions.

Windows

Supported operating systems

Windows 11 64-bit
Windows 10 64-bit

Computer hardware requirements

Windows computer with a USB 2.0 (or higher) port*

* Operation is not guaranteed using the TASCAM driver with ARM64 CPUs.

Mac

Supported operating systems

macOS Ventura (13)
macOS Monterey (12)
macOS Big Sur (11)
macOS Catalina (10.15)

Computer hardware requirements

Mac with a USB 2.0 (or higher) port

Other

Power

AC 100-240V, 50/60Hz

Power consumption

Sonicview 16: 65W
Sonicview 24: 85W

External dimensions

Sonicview 16: 472.0 x 228.1 x 554.4 mm
Sonicview 24: 690.8 x 228.1 x 554.4 mm
(width x height x depth)

Weight

Sonicview 16: 13 kg
Sonicview 24: 18 kg

Operating temperature range

0 – 40°C (32 – 104°F)

- Illustrations in this reference manual might differ in part from the actual product.
- Specifications and external appearance might be changed without notification to improve the product.

Dimensional drawings

Sonicview 16

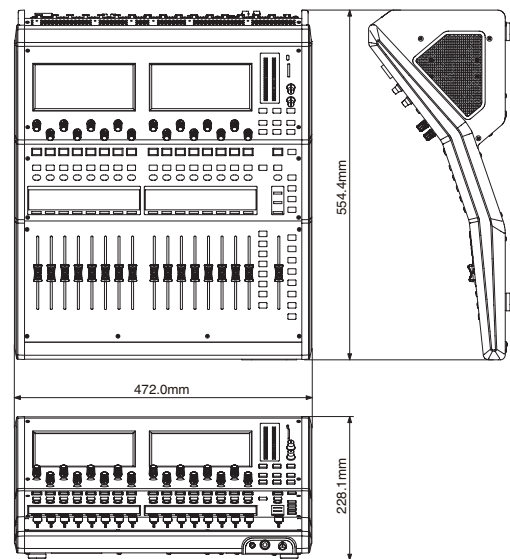

Sonicview 24

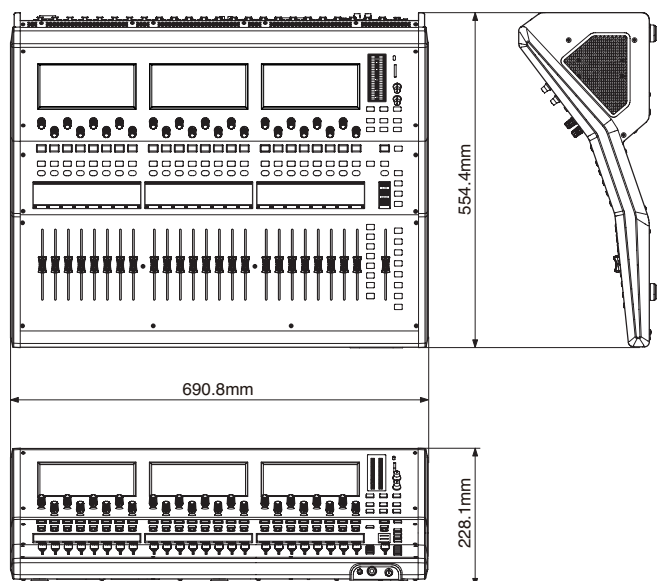

16 - Block diagram

Sonicview V1.2.0

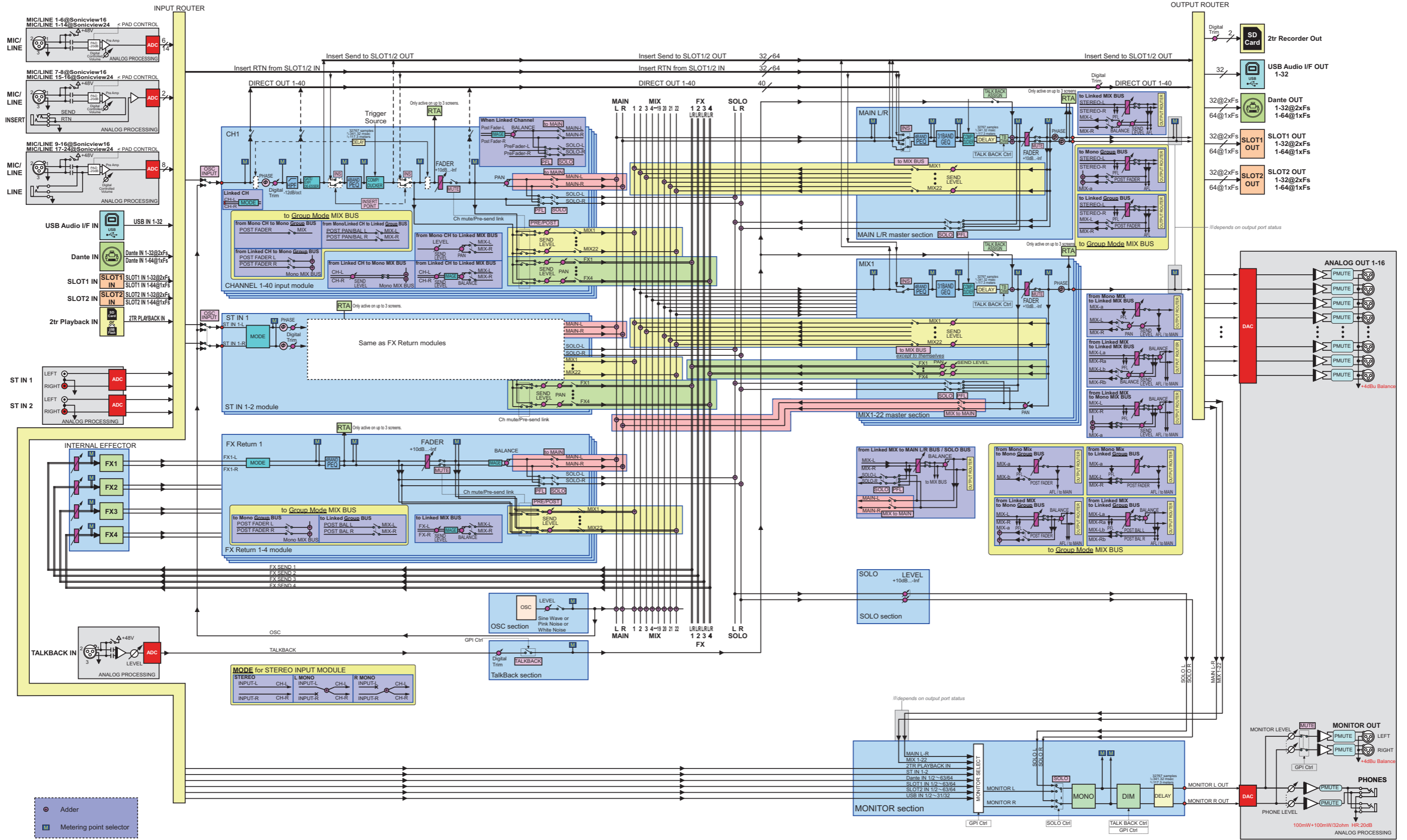

- [NOTE] • Supported Sync Clock Fs : 96kHz / 48kHz
 • Support 8 DCA Groups and 8 Mute Groups
 • Do not connect both the XLR and 1/4" Line input on the same channel.
 • Comp Key-in Trigger Source : SELF, CH1-40 Pre Comp, MIX1-22 Pre Comp, MAIN L/R Pre Com
 • Ducker Key-in Trigger Source : none, CH1-40 Post Fader, MIX1-22 Post Fader, MAIN L/R Post Fader

Sonicview 16/Sonicview 24 Mixer Audio Block Diagram

TASCAM

17 – Parameter tables

Sonicview 16/24 Mixer Basic Parameters

Libraries

| Name | User | Preset |
|-------------------|------|--------|
| Snapshot | 128 | 1 |
| MODULE INPUT | 128 | 2 |
| MODULE FX RTN | 128 | 4 |
| MODULE OUTPUT | 128 | 1 |
| EQ | 128 | 18 |
| GEQ | 128 | 0 |
| GATE/EXP/DE-ESSER | 128 | 11 |
| COMP/DUCKER | 128 | 12 |
| FX | 128 | 14 |

Input Modules

| Function | | Parameter | steps | Fine Step (when LCD knob turned without being pressed) | Coarse Steps (when LCD knob turned while being pressed) |
|-------------------|-------------------|--|-------|---|--|
| Pre Amp | Analog Gain | <p>When Analog Reference Level is +4 dBu and Digital Reference Level is -20 dBFS</p> <p>When PAD OFF: +12 dB – +66 dB When PAD ON: -8 dB – +46 dB</p> <p>NOTE See “Preamp analog gain for every reference level” on page 254 for value ranges for various analog and digital reference levels.</p> | 55 | 1 dB/click | 2 dB/click |
| | PAD | OFF/ON | | | |
| | Phantom | OFF/ON | | | |
| OSC INPUT | | OFF/ON | | | |
| Phase Sw | | Normal/Reverse | | | |
| D.TRIM | | -50.0 dB – +20.0 dB | 141 | 0.5 dB/click | 2.0 dB/click |
| HPF | Switch | OFF/ON | | | |
| | Freq | 20 Hz – 1.0 kHz | 69 | 1 point/click 1/12 oct/click | 3 step/click 1/4 oct/click |
| DIRECT OUT | Direct Out Switch | OFF/ON | | | |
| | Direct Out Point | INPUT/POST HPF/POST FADER | | | |
| | Direct Out Trim | -20.0 dB – +20.0 dB | 401 | 0.1 dB/click | 2.0 dB/click |
| INSERT | Switch | OFF/ON | | | |
| | Insert Point | PRE EQ/PRE FADER | | | |
| GATE/EXP/DE-ESSER | Dynamics1 Switch | OFF/ON | | | |
| | Dynamics1 Type | GATE/EXPANDER/DE-ESSER | | | |
| GATE | Gate Threshold | -80 dB – 0 dB | 81 | 1 dB/click | 4 dB/click |
| | Gate Range | -60 dB – 0 dB | 61 | 1 dB/click | 3 dB/click |
| | Gate Attack | 0 ms – 125 ms | 126 | 1 ms/click | 5 ms/click |
| | Gate Hold | 0 ms – 990 ms | 100 | 10 ms/click | 50 ms/click |
| | Gate Decay | 5 ms – 5.00 s | 100 | 1 point/click | 5 point/click |

17 – Parameter tables

| Function | | Parameter | steps | Fine Step (when LCD knob turned without being pressed) | Coarse Steps (when LCD knob turned while being pressed) |
|---------------------|----------------------|---|----------------|---|--|
| EXP | Expander Threshold | -60 dB – 0 dB | 61 | 1 dB/click | 3 dB/click |
| | Expander Ratio | 1:1, 2:1, 4:1, 8:1, 16:1, 32:1, 64: 1 | 7 | 1 point/click | 1 point/click |
| | Expander Knee | HARD/MID/SOFT | 3 | 1 point/click | 1 point/click |
| | Expander Attack | 0 ms – 125 ms | 126 | 1 ms/click | 5 ms/click |
| | Expander ReleaseTime | 5 ms - 5.00 s | 100 | 1 point/click | 5 point/click |
| DE-ESSER | De-Esser Threshold | -40 dB – 0 dB | 41 | 1 dB/click | 2 dB/click |
| | De-Esser Knee | HARD/MID/SOFT | 3 | 1 point/click | 1 point/click |
| | De-Esser CenterFreq | 1.0 kHz – 10.0 kHz | 91 | 0.1 kHz/step | 0.5 kHz/step |
| | De-Esser Q | 1.04 – 17.31 | 28 | 1 point/click | 1 point/click |
| 4 BAND EQ | Switch | OFF/ON | | | |
| | Band Switch | OFF/ON | | | |
| | Gain | -18.0 – +18.0 | 361 | 0.1 dB/click | 1.0 dB/click |
| | Freq | 20 Hz – 20.0 kHz | 121 | 1 point/click 1/12 oct/click | 6 point/click 1/2 oct/click |
| | Q | 0.10 – 17.31 | 55 | 1 point/click | 3 point/click |
| | Type (LO) | L.Shelf/Bell | | | |
| | Type (HI) | H.Shelf/Bell/LPF | | | |
| 31 BAND GEQ | Switch | OFF/ON | | | |
| | Gain | -18.0 – +18.0 | 361 | 0.1 dB/click | 1.0 dB/click |
| COMP/ DUCKER | Switch | OFF/ON | | | |
| | Type | COMP/DUCKER | | | |
| | Key In Source | SELF, CH 1–40, MIX 1–22, MAIN L/R | | | |
| | Key In Filter Switch | OFF/ON | | | |
| | Key In Filter Type | HPF/BPF/LPF | | | |
| | Key In Filter Freq | 20 Hz – 20.0 kHz | 121 | 1 point/click 1/12 oct/click | 6 point/click 1/2 oct/click |
| | Key In Filter Q | 0.10 – 17.31 | 55 | 1 point/click | 3 point/click |
| COMP | Comp Thresh | -49 dB – 0 dB | 50 | 1 dB/click | 2 dB/click |
| | Comp Ratio | 1.00:1 – ∞:1 | 21 | 1 point/click | 1 point/click |
| | Comp Knee | HARD HARD MID MID SOFT MID SOFT SMOOTH | 6 | 1 point/click | 1 point/click |
| | Comp Attack | 0.02 ms – 125 ms | 135 | 1 point/click | 5 point/click |
| | Comp Release | 5 ms – 5.00 s | 100 | 1 point/click | 5 point/click |
| | Comp Auto Makeup | OFF/ON | | | |
| | Comp Output Gain | 0 dB – 20 dB | 21 | 1 dB/click | 1 dB/click |
| | DUCKER | Ducker Threshold | -30 dB – -6 dB | 5 | 6 dB/click |
| Ducker Attenuation | | -∞, -24, -18, -12, -9, -6, -3 (dB) | 7 | 1 point/click | 1 point/click |
| Ducker HoldTime | | 0.1 sec – 5.0 sec | 50 | 0.1 sec/click | 0.1 sec/click |
| Ducker Release Time | | 0.1 sec – 5.0 sec | 50 | 0.1 sec/click | 0.1 sec/click |
| DELAY | Delay Switch | OFF/ON | | | |
| | Delay Time | 0.0 meter – 117.3 meter 0.0 feet – 384.8 feet 0.00 msec – 341.32 msec | | 0.1 meter/click 0.1 feet/click 0.02 msec/click | 2.0 meter/click 5.0 feet/click 5.00 msec/click |
| | Delay Point | INPUT/PRE FADER | | | |
| | Delay Edit Unit | meter/feet/msec | | | |

17 – Parameter tables

| Function | Parameter | steps | Fine Step (when LCD knob turned without being pressed) | Coarse Steps (when LCD knob turned while being pressed) |
|-----------------|-----------------------------------|---------------------------|---|--|
| FADER LEVEL | -∞ dB, -120 dB – +10.0 dB | 1024 | 1 point/click (-10 dB - +10 dB: 0.05 dB/click) | 40 point/click (-10 dB - +10 dB: 2 dB/click) |
| MUTE | OFF/ON | | | |
| MAIN L/R Assign | OFF/ON | | | |
| PAN/BAL | L100 – C – R100 | 201 | 1 point/click | 10 point/click |
| IMAGE | STEREO 100% – MONO – REVERSE 100% | 101 | 2%/click | 10%/click |
| MODE | STEREO/L-MONO/R-MONO | 3 | | |
| Send | Send Level | -∞ dB, -120 dB – +10.0 dB | 1024 (-10 dB - +10 dB: 0.05 dB/click) | 40 point/click (-10 dB - +10 dB: 2 dB/click) |
| | Send Pan | L100 – C – R100 | 201 | 10 point/click |
| | Send Switch | OFF/ON | | |
| | Send Point | PRE/POST | | |
| DCA | 8 DCAs | | | |
| Mute Group | 8 Groups | | | |
| Stereo Link | OFF/ON | | | |

- Preamp analog gain for every reference level

| When Analog Reference Level is +6 dBu and Digital Reference Level is -9 dBFS | |
|--|-----------------|
| When PAD OFF | +3 dB – +57 dB |
| When PAD ON | -17 dB – +37 dB |
| When Analog Reference Level is +4 dBu and Digital Reference Level is -20 dBFS | |
| When PAD OFF | +12 dB – +66 dB |
| When PAD ON | -8 dB – +46 dB |
| When Analog Reference Level is +4 dBu and Digital Reference Level is -18 dBFS | |
| When PAD OFF | +10 dB – +64 dB |
| When PAD ON | -10 dB – +44 dB |
| When Analog Reference Level is +4 dBu and Digital Reference Level is -16 dBFS | |
| When PAD OFF | +8 dB – +62 dB |
| When PAD ON | -12 dB – +42 dB |
| When Analog Reference Level is +4 dBu and Digital Reference Level is -14 dBFS | |
| When PAD OFF | +6 dB – +60 dB |
| When PAD ON | -14 dB – +40 dB |
| When Analog Reference Level is 0 dBu and Digital Reference Level is -20 dBFS | |
| When PAD OFF | +8 dB – +62 dB |
| When PAD ON | -12 dB – +42 dB |
| When Analog Reference Level is 0 dBu and Digital Reference Level is -18 dBFS | |
| When PAD OFF | +6 dB – +60 dB |
| When PAD ON | -14 dB – +40 dB |

Output Modules

| Function | | Parameter | steps | Fine Step (when LCD knob turned without being pressed) | Coarse Steps (when LCD knob turned while being pressed) |
|--------------------|----------------------|---|----------------|---|--|
| Insert | Switch | OFF/ON | | | |
| 4 BAND EQ | Switch | OFF/ON | | | |
| | Band Switch | OFF/ON | | | |
| | Gain | -18.0 - +18.0 | 361 | 0.1 dB/click | 1.0 dB/click |
| | Freq | 20 Hz – 20.0 kHz | 121 | 1 point/click 1/12 oct/click | 6 point/click 1/2 oct/click |
| | Q | 0.10 – 17.31 | 55 | 1 point/click | 3 point/click |
| | Type (LO) | L.Shelf/Bell | | | |
| | Type (HI) | H.Shelf/Bell/LPF | | | |
| 31 BAND GEQ | Switch | OFF/ON | | | |
| | GAIN | -18.0 – +18.0 | 361 | 0.1 dB/click | 1.0 dB/click |
| COMP/DUCKER | Switch | OFF/ON | | | |
| | Type | COMP/DUCKER | | | |
| | Key In Source | SELF, CH 1–40, MIX 1–22, MAIN L/R | | | |
| | Key In Filter Switch | OFF/ON | | | |
| | Key In Filter Type | HPF/BPF/LPF | | | |
| | Key In Filter Freq | 20 Hz – 20.0 kHz | 121 | 1 point/click 1/12 oct/click | 6 point/click 1/2 oct/click |
| | Key In Filter Q | 0.10 – 17.31 | 55 | 1 point/click | 3 point/click |
| COMP | Comp Thresh | - 49 dB – 0 dB | 50 | 1 dB/click | 2 dB/click |
| | Comp Ratio | 1.00:1 – ∞:1 | 21 | 1 point/click | 1 point/click |
| | Comp Knee | HARD HARD MID MID SOFT MID SOFT SMOOTH | 6 | 1 point/click | 1 point/click |
| | Comp Attack | 0.02 ms – 125 ms | 135 | 1 point/click | 5 point/click |
| | Comp Release | 5 ms – 5.00 s | 100 | 1 point/click | 5 point/click |
| | Comp Auto Makeup | OFF/ON | | | |
| | Comp Output Gain | 0 dB – +20 dB | 21 | 1 dB/click | 1 dB/click |
| | DUCKER | Ducker Threshold | -30 dB – -6 dB | 5 | 6 dB/click |
| Ducker Attenuation | | -∞, -24, -18, -12, -9, -6, -3 (dB) | 7 | 1 point/click | 1 point/click |
| Ducker HoldTime | | 0.1 sec, 0.5 – 5.0 sec | 11 | 1 point/click | 1 point/click |
| DELAY | Delay Switch | OFF/ON | | | |
| | Delay Time | 0.0 meter – 117.3 meter 0.0 feet – 384.8 feet 0.00 msec – 341.32 msec | | 0.1 meter/click 0.1 feet/click 0.02 msec/click | 2.0 meter/click 5.0 feet/click 5.00 msec/click |
| | Delay Point | INPUT/PRE FADER | | | |
| | Delay Edit Unit | meter/feet/msec | | | |
| FADER LEVEL | | -∞ dB, -120 dB – +10.0 dB | 1024 | 1 point/click (-10 dB - +10 dB: 0.05 dB/click) | 40 point/click (-10 dB - +10 dB: 2 dB/click) |
| MUTE | | OFF/ON | | | |
| Phase Sw | | Normal/Reverse | | | |
| Main L/R Assign | | OFF/ON | | | |
| Pan Bal | | L100 – C – R100 | 201 | 1 point/click | 10 point/click |

17 – Parameter tables

| Function | | Parameter | steps | Fine Step (when LCD knob turned without being pressed) | Coarse Steps (when LCD knob turned while being pressed) |
|-------------------------|-----------------------|---|-------|---|--|
| MIX to Main L/R Send | Send Level | $-\infty$ dB, - 120 dB – +10.0 dB | 1024 | 1 point/click (-10 dB - +10dB: 0.05 dB/click) | 40 point/click (-10 dB - +10 dB: 2 dB/click) |
| | Send Pan | L100 – C – R100 | 201 | 1 point/click | 10 point/click |
| | Send Switch | OFF/ON | | | |
| DCA | | 8 DCAs | | | |
| Mute Group | | 8 Groups | | | |
| Stereo Link | | OFF/ON | | | |
| Bus Mode | | AUX/GROUP | | | |
| Pan Link | | OFF/ON | | | |
| OSC | OSC Switch | OFF/ON | | | |
| | OSC Level | -36 dB – 0 dB | 37 | 1 dB/click | 2 dB/click |
| | OSC Type | Sine Wave/Pink Noise/White Noise | | | |
| | OSC Freq | 100 Hz/440 Hz/1 kHz/10 kHz | | | |
| Monitor | Monitor Mono | OFF/ON | | | |
| | Monitor Dimmer Switch | OFF/ON | | | |
| | Monitor Dimmer Level | -40 dB – 0 dB | 41 | 1 dB/click | 2 dB/click |
| | Monitor Delay Switch | OFF/ON | | | |
| | Monitor Delay Time | 0.0 meter – 117.3 meter 0.0 feet – 384.8 feet 0.00 msec – 341.32 msec | | 0.1 meter/click 0.1 feet/click 0.02 msec/click | 2.0 meter/click 5.0 feet/click 5.00 msec/click |

Sonicview 16/24 Mixer Basic Parameters (FX)

FX common

| Function | Parameter | steps | Fine Step (when LCD knob turned without being pressed) | Coarse Steps (when LCD knob turned while being pressed) | |
|----------|-----------------|---------------------------|---|--|---|
| FX | FX Input Level | -∞ dB, -120 dB – +10.0 dB | 1024 | 1 point/click (-10 dB – +10 dB: 0.05 dB/click) | 40 point/click (-10 dB – +10 dB: 2 dB/click) |
| | FX Output Level | -∞ dB, -120 dB – +10.0 dB | 1024 | 1 point/click (-10 dB – +10 dB: 0.05 dB/click) | 40 point/click (-10 dB – +10 dB: 2 dB/click) |
| | FX Mix Level | 0% – 100% | 101 | 1%/click | 5%/click |

FX

| Function | Parameter | steps | Fine Step (when LCD knob turned without being pressed) | Coarse Steps (when LCD knob turned while being pressed) | Description | |
|---------------|--------------|---------------------------|---|---|---|---|
| REVERB | TYPE | HALL/ROOM/ STUDIO/LIVE | 4 | 1 point/click | 1 point/click | Reverb type |
| | PRE DELAY | 0 msec – 200 msec | 201 | 1 msec/click | 10 msec/click | Time before reverb starts after sound is input |
| | REVERB TIME | 0.1 sec – 10.0 sec | 61 | 0.1 sec/click (0 – 5.0 sec) 0.5 sec/click (5.0 – 10.0 sec) | 0.2 sec/click (0 – 5.0 sec) 1.0 sec/click (5.0 – 10.0 sec) | Reverb time |
| | SPREAD | 0% – 100% | 101 | 1%/click | 5%/click | Reverb spread |
| STEREO REVERB | TYPE | HALL/ROOM | 2 | 1 point/click | 1 point/click | Reverb type |
| | PRE DELAY | 0 msec – 200 msec | 201 | 1 msec/click | 10 msec/click | Time before reverb starts after sound is input |
| | REVERB TIME | 0.1 sec – 20.0 sec | 71 | 0.1 sec/click (0 – 5.0 sec) 0.5 sec/click (5.0 – 10.0 sec) 1.0 sec/click (10.0 – 20.0 sec) | 0.2 sec/click (0 – 5.0 sec) 1.0 sec/click (5.0 – 10.0 sec) 2.0 sec/click (10.0 – 20.0 sec) | Reverb time |
| | SPREAD | 0% – 100% | 101 | 1%/click | 5%/click | Reverb spread |
| | LO/HIGH GAIN | -12.0 dB – +12.0 dB | 49 | 0.5 dB/click | 1.0 dB/click | Shelf filter gain |
| | LO FREQ | 125 Hz – 2.0 kHz | 49 | 1 point/click | 3 point/click | Cutoff frequency of the low-shelf filter |
| | HIGH FREQ | 1.00 kHz – 16.00 kHz | 49 | 1 point/click | 3 point/click | Cutoff frequency of the high-shelf filter |
| PLATE REVERB | TYPE | WARM/HARD/ BRIGHT/DARK | 4 | 1 point/click | 1 point/click | Reverb type |
| | PRE DELAY | 0 msec – 200 msec | 201 | 1 msec/click | 10 msec/click | Time before reverb starts after sound is input |
| | REVERB TIME | 0.1 sec – 10.0 sec | 61 | 0.1 sec/click (0 – 5.0 sec) 0.5 sec/click (5.0 – 10.0 sec) | 0.2 sec/click (0 – 5.0 sec) 1.0 sec/click (5.0 – 10.0 sec) | Reverb time |
| | HI DAMP | 500 Hz – 16.0 kHz | 61 | 1 point/click | 3 point/click | Cutoff frequency of reverb high-frequency attenuation |

17 – Parameter tables

| Function | | Parameter | steps | Fine Step (when LCD knob turned without being pressed) | Coarse Steps (when LCD knob turned while being pressed) | Description |
|-----------------|------------------|--------------------|-------|---|---|--|
| GATE REVERB | TYPE | FAST/SLOW | 2 | 1 point/click | 1 point/click | Gate behavior Fast: Gate opens quickly when Gate Level is exceeded It opens for the set Gate Time. Slow: Gate opens gradually when Gate Level is exceeded It opens completely after the set Gate Time has elapsed. |
| | GATE LEVEL | -48 dB – 0 dB | 49 | 1 dB/click | 2 dB/click | Level at which the gate opens |
| | GATE TIME | 10 msec – 3.0 sec | 201 | 1 msec/click (0 – 100 msec) 10 msec/click (100 msec – 1.0 sec) 0.1 sec/click (1.0 – 3.0 sec) | 10 msec/click (0 – 100 msec) 100 msec/click (100 msec – 1.0 sec) | Time that the gate is open |
| MONO DELAY | DELAY TIME | 1 msec – 3000 msec | 3000 | 1 msec/click | 100 msec/click | Delay time |
| | FEEDBACK | 0 – 100 | 101 | 1 point/click | 5 point/click | Feedback amount |
| | HI DAMP | 500 Hz – 16.0 kHz | 61 | 1 point/click | 3 point/click | Cutoff frequency of high-frequency attenuation |
| STEREO DELAY | DELAY TIME | 1 msec – 1500 msec | 1500 | 1 msec/click | 100 msec/click | Delay time |
| | FEEDBACK | 0 – 100 | 101 | 1 point/click | 5 point/click | Feedback amount |
| | HI DAMP | 500 Hz – 16.0 kHz | 61 | 1 point/click | 3 point/click | Cutoff frequency of high-frequency attenuation |
| PING-PONG DELAY | DELAY TIME | 1 msec – 1500 msec | 1500 | 1 msec/click | 100 msec/click | Delay time |
| | FEEDBACK | 0 – 100 | 101 | 1 point/click | 5 point/click | Feedback amount |
| | HI DAMP | 500 Hz – 16.0 kHz | 61 | 1 point/click | 3 point/click | Cutoff frequency of high-frequency attenuation |
| DELAY LCR | HI DAMP | 500 Hz – 16.0 kHz | 61 | 1 point/click | 3 point/click | Cutoff frequency of high-frequency attenuation |
| | DELAY TIME L/C/R | 1 msec – 3000 msec | 3000 | 1 msec/click | 100 msec/click | Delay time |
| | FEEDBACK | 0 – 100 | 101 | 1 point/click | 5 point/click | Feedback amount |
| | WET LEVEL L/C/R | 0 – 100 | 101 | 1 point/click | 5 point/click | Wet level |

17 – Parameter tables

| Function | | Parameter | steps | Fine Step (when LCD knob turned without being pressed) | Coarse Steps (when LCD knob turned while being pressed) | Description |
|----------|---------------|---------------------|-------|---|--|---|
| CHORUS | RATE | 0.05 Hz – 10.0 Hz | 101 | 1 point/click | 5 point/click | Chorus modulation frequency |
| | DEPTH | 0% – 100% | 101 | 1%/click | 5%/click | Chorus depth |
| | DELAY TIME | 0 msec – 100 msec | 101 | 1 msec/click | 5 msec/click | Time until wet level is output |
| | HI PASS | 22 Hz – 2.00 kHz | 79 | 1 point/click | 3 point/click | High pass filter that limits the frequency of input signals |
| | HI DAMP | 500 Hz – 16.0 kHz | 61 | 1 point/click | 3 point/click | Cutoff frequency of high-frequency attenuation |
| | SPREAD | 0% – 100% | 101 | 1%/click | 5%/click | Left-right width effect |
| FLANGER | RATE | 0.05 Hz – 10.0 Hz | 101 | 1 point/click | 5 point/click | Flanger modulation frequency |
| | DEPTH | 0% – 100% | 101 | 1%/click | 5%/click | Flanger depth |
| | DELAY TIME | 0 msec – 100 msec | 101 | 1 msec/click | 5 msec/click | Time until wet level is output |
| | PHASE | 0 deg – 180 deg | 181 | 1 deg/click | 10 deg/click | Left-right modulation phase difference |
| PHASER | RATE | 0.05 Hz – 10.0 Hz | 101 | 1 point/click | 5 point/click | Phaser modulation frequency |
| | STAGE | 4/8/12/16 | 4 | 1 point/click | 1 point/click | The number of phase steps |
| | RESONANCE | 0 – 10 | 11 | 1 point/click | 1 point/click | Amount of resonance applied to the feedback sound |
| | PHASE | 0 deg – 180 deg | 181 | 1 deg/click | 10 deg/click | Left-right modulation phase difference |
| PITCH | PITCH 1/2 | -24 – +24 | 49 | 1 point/click | 2 point/click | Shift amount (in semitones) |
| | FINE TUNE 1/2 | -50 Cent – +50 Cent | 101 | 1 cent/click | 5 cent/click | Shift amount (in cents) |

17 – Parameter tables

Sonicview 16/24 Preset List

Gate Library Preset List

| No. | TYPE | NAME | Parameters | | | | |
|------|----------|------------------|------------|--------|---------|----------|----------|
| | | | Threshold | Range | Attack | Hold | Decay |
| P001 | GATE | Floor Tom | -20 dB | -40 dB | 0 msec | 60 msec | 320 msec |
| P002 | GATE | Kick in | -30 dB | -50 dB | 0 msec | 110 msec | 95 msec |
| P003 | GATE | Kick out | -35 dB | -50 dB | 0 msec | 100 msec | 85 msec |
| P004 | GATE | Noise Gate | -28 dB | -60 dB | 0 msec | 50 msec | 300 msec |
| P005 | GATE | Rack Tom 1 | -20 dB | -40 dB | 0 msec | 60 msec | 380 msec |
| P006 | GATE | Rack Tom 2 | -20 dB | -40 dB | 0 msec | 60 msec | 300 msec |
| P007 | GATE | Snare bottom | -28 dB | -40 dB | 0 msec | 90 msec | 300 msec |
| P008 | EXP | EXP Snare bottom | -27 dB | 4:1 | Mid | 60 msec | 280 msec |
| P009 | EXP | EXP Tom | -28 dB | 4:1 | Mid | 60 msec | 380 msec |
| P010 | DE-ESSER | DE-ESS Vocal 2k | -28 dB | Mid | 2.5 kHz | 3.45 | |
| P011 | DE-ESSER | DE-ESS Vocal 4k | -28 dB | Mid | 4.2 kHz | 4.32 | |

EQ Library Preset List

| No. | NAME | Parameters | | | | | | | |
|------|-----------|------------|---------|---------|---------|--------|----------|------|----------|
| | | Low | | Low Mid | | Hi Mid | | Hi | |
| P001 | A.Gtr 1 | Q | - | Q | 1.90 | Q | - | Q | Hi Shelf |
| | | Freq | - | Freq | 397 Hz | Freq | - | Freq | 3.56 kHz |
| | | Gain | - | Gain | -2.5 dB | Gain | - | Gain | 1.5 dB |
| P002 | A.Gtr 2 | Q | 4.94 | Q | 2.02 | Q | 2.02 | Q | Hi Shelf |
| | | Freq | 140 Hz | Freq | 375 Hz | Freq | 3.17 kHz | Freq | 5.04 kHz |
| | | Gain | -3.0 dB | Gain | -3.0 dB | Gain | +3.5 dB | Gain | +1.0 dB |
| P003 | Bass Line | Q | 7.99 | Q | - | Q | 2.14 | Q | - |
| | | Freq | 132 Hz | Freq | - | Freq | 1.59 kHz | Freq | - |
| | | Gain | -3.0 dB | Gain | - | Gain | +4.0 dB | Gain | - |
| P004 | Bass mic | Q | - | Q | 2.02 | Q | 2.02 | Q | - |
| | | Freq | - | Freq | 265 Hz | Freq | 3.00 kHz | Freq | - |
| | | Gain | - | Gain | -5.0 dB | Gain | +5.0 dB | Gain | - |

17 – Parameter tables

| No. | NAME | Parameters | | | | | | | |
|------|--------------|------------|---------|----------------|---------|---------------|----------|-----------|----------|
| P005 | E.Gtr | Low | | Low Mid | | Hi Mid | | Hi | |
| | | Q | - | Q | 1.90 | Q | - | Q | Hi Shelf |
| | | Freq | - | Freq | 397 Hz | Freq | - | Freq | 3.56 kHz |
| | | Gain | - | Gain | -2.5 dB | Gain | - | Gain | +1.5 dB |
| P006 | Floor Tom | Low | | Low Mid | | Hi Mid | | Hi | |
| | | Q | 2.02 | Q | 1.41 | Q | - | Q | 1.80 |
| | | Freq | 79 Hz | Freq | 420 Hz | Freq | - | Freq | 5.04 kHz |
| | | Gain | +3.5 dB | Gain | -4.0 dB | Gain | - | Gain | +3.0 dB |
| P007 | Hi Hat | Low | | Low Mid | | Hi Mid | | Hi | |
| | | Q | - | Q | 0.92 | Q | - | Q | - |
| | | Freq | - | Freq | 472 Hz | Freq | - | Freq | - |
| | | Gain | - | Gain | -8.0 dB | Gain | - | Gain | - |
| P008 | Kick in | Low | | Low Mid | | Hi Mid | | Hi | |
| | | Q | - | Q | 1.90 | Q | 2.46 | Q | - |
| | | Freq | - | Freq | 315 Hz | Freq | 4.49 kHz | Freq | - |
| | | Gain | - | Gain | -4.0 dB | Gain | +8.0 dB | Gain | - |
| P009 | Kick out | Low | | Low Mid | | Hi Mid | | Hi | |
| | | Q | 2.46 | Q | 1.04 | Q | 1.41 | Q | - |
| | | Freq | 63 Hz | Freq | 375 Hz | Freq | 3.78 kHz | Freq | - |
| | | Gain | +3.0 dB | Gain | -6.0 dB | Gain | +7.0 dB | Gain | - |
| P010 | Over Head | Low | | Low Mid | | Hi Mid | | Hi | |
| | | Q | - | Q | 1.20 | Q | - | Q | Hi Shelf |
| | | Freq | - | Freq | 445 Hz | Freq | - | Freq | 4.24 kHz |
| | | Gain | - | Gain | -6.0 dB | Gain | - | Gain | +1.5 dB |
| P011 | Rack Tom 1 | Low | | Low Mid | | Hi Mid | | Hi | |
| | | Q | - | Q | 1.41 | Q | - | Q | 1.41 |
| | | Freq | - | Freq | 472 Hz | Freq | - | Freq | 4.76 kHz |
| | | Gain | - | Gain | -4.0 dB | Gain | - | Gain | +6.0 dB |
| P012 | Rack Tom 2 | Low | | Low Mid | | Hi Mid | | Hi | |
| | | Q | - | Q | 1.41 | Q | - | Q | 1.04 |
| | | Freq | - | Freq | 397 Hz | Freq | - | Freq | 4.24 kHz |
| | | Gain | - | Gain | -4.0 dB | Gain | - | Gain | +4.0 dB |
| P013 | Ride | Low | | Low Mid | | Hi Mid | | Hi | |
| | | Q | - | Q | 1.41 | Q | - | Q | Hi Shelf |
| | | Freq | - | Freq | 397 Hz | Freq | - | Freq | 4.24 kHz |
| | | Gain | - | Gain | -8.0 dB | Gain | - | Gain | +1.5 dB |
| P014 | Snare bottom | Low | | Low Mid | | Hi Mid | | Hi | |
| | | Q | - | Q | 1.41 | Q | 2.02 | Q | Hi Shelf |
| | | Freq | - | Freq | 297 Hz | Freq | 3.36 kHz | Freq | 2.52 kHz |
| | | Gain | - | Gain | -4.0 dB | Gain | +3.0 dB | Gain | +2.0 dB |
| P015 | Snare top | Low | | Low Mid | | Hi Mid | | Hi | |
| | | Q | - | Q | 1.90 | Q | 2.02 | Q | Hi Shelf |
| | | Freq | - | Freq | 445 Hz | Freq | 3.36 kHz | Freq | 2.00 kHz |
| | | Gain | - | Gain | -3.5 dB | Gain | +3.0 dB | Gain | +5.0 dB |
| P016 | Synth Bass | Low | | Low Mid | | Hi Mid | | Hi | |
| | | Q | 4.32 | Q | - | Q | 3.84 | Q | - |
| | | Freq | 70 Hz | Freq | - | Freq | 3.17 kHz | Freq | - |
| | | Gain | +3.0 dB | Gain | - | Gain | -3.0 dB | Gain | - |

17 – Parameter tables

| No. | NAME | Parameters | | | | | | | |
|------|--------------|------------|---------|----------------|---------|---------------|----------|-----------|----------|
| P017 | Vocal Female | Low | | Low Mid | | Hi Mid | | Hi | |
| | | Q | 3.13 | Q | 1.80 | Q | 3.45 | Q | Hi Shelf |
| | | Freq | 281 Hz | Freq | 595 Hz | Freq | 2.83 kHz | Freq | 5.04 kHz |
| | | Gain | -3.5 dB | Gain | -3.5 dB | Gain | -2.0 dB | Gain | +2.0 dB |
| P018 | Vocal Male | Low | | Low Mid | | Hi Mid | | Hi | |
| | | Q | 4.32 | Q | 2.87 | Q | 3.84 | Q | Hi Shelf |
| | | Freq | 210 Hz | Freq | 375 Hz | Freq | 4.49 kHz | Freq | 5.04 kHz |
| | | Gain | -3.0 dB | Gain | -3.5 dB | Gain | -2.0 dB | Gain | +3.0 dB |

Comp Library Preset List

| No. | NAME | Parameters | | | | | |
|------|--------------|------------------|--------------|-------------|---------------|----------------|--------------------|
| P001 | A.Gtr | Threshold | Ratio | Knee | Attack | Release | Output Gain |
| | | -29 dB | 2.50:1 | Mid | 1 msec | 200 msec | +2 dB |
| P002 | Bass Line | Threshold | Ratio | Knee | Attack | Release | Output Gain |
| | | -27 dB | 3.33:1 | Mid | 30 msec | 230 msec | +2 dB |
| P003 | Bass mic | Threshold | Ratio | Knee | Attack | Release | Output Gain |
| | | -30 dB | 3.33:1 | Hard | 20 msec | 125 msec | +3 dB |
| P004 | Keyboard | Threshold | Ratio | Knee | Attack | Release | Output Gain |
| | | -17 dB | 2.50:1 | Mid | 50 msec | 200 msec | +0 dB |
| P005 | Kick in | Threshold | Ratio | Knee | Attack | Release | Output Gain |
| | | -20 dB | 2.86:1 | Mid | 20 msec | 30 msec | +3 dB |
| P006 | Kick out | Threshold | Ratio | Knee | Attack | Release | Output Gain |
| | | -19 dB | 2.50:1 | Mid | 20 msec | 40 msec | +3 dB |
| P007 | Snare bottom | Threshold | Ratio | Knee | Attack | Release | Output Gain |
| | | -30 dB | 2.50:1 | Mid | 30 msec | 230 msec | +0 dB |
| P008 | Snare top | Threshold | Ratio | Knee | Attack | Release | Output Gain |
| | | -26 dB | 3.33:1 | Mid | 15 msec | 65 msec | +3 dB |
| P009 | Synth Bass | Threshold | Ratio | Knee | Attack | Release | Output Gain |
| | | -28 dB | 3.33:1 | Mid | 30 msec | 150 msec | +0 dB |
| P010 | Vocal Cho | Threshold | Ratio | Knee | Attack | Release | Output Gain |
| | | -28 dB | 3.33:1 | Mid | 30 msec | 150 msec | +1 dB |
| P011 | Vocal Female | Threshold | Ratio | Knee | Attack | Release | Output Gain |
| | | -25 dB | 2.50:1 | Mid | 25 msec | 150 msec | +3 dB |
| P012 | Vocal Male | Threshold | Ratio | Knee | Attack | Release | Output Gain |
| | | -24 dB | 2.50:1 | Mid | 25 msec | 200 msec | +3 dB |

FX Library Preset List

| No. | FX TYPE | Name | Parameters | | | | | | | |
|------|---------|-----------------|------------|--------------|--------------|--------------|----------|-------------|-------------|-------------|
| | | | TYPE | PRE DELAY | REVERB TIME | SPREAD | | | | |
| P001 | REVERB | Dr Rev | LIVE | 6 msec | 2.0 sec | 70% | | | | |
| | | | | | | | | | | |
| P002 | GT-REV | Gate Rev | TYPE | GATE LEVEL | GATE TIME | | | | | |
| | | | Fast | -20 dB | 810 msec | | | | | |
| P003 | ST-REV | Inst Rev | TYPE | PRE DELAY | REVERB TIME | SPREAD | LO GAIN | LO FREQ | HI GAIN | HI FREQ |
| | | | HALL | 20 msec | 2.2 sec | 80% | 3.0 dB | 132 Hz | 2.0 dB | 1.89 kHz |
| P004 | PL-REV | SN Rev | TYPE | PRE DELAY | REVERB TIME | HI DAMP | | | | |
| | | | BRIGHT | 20 msec | 1.8 sec | 4.00 kHz | | | | |
| P005 | PL-REV | Vo Rev 1 | TYPE | PRE DELAY | REVERB TIME | HI DAMP | | | | |
| | | | WARM | 80 msec | 2.8 sec | 8.00 kHz | | | | |
| P006 | REVERB | Vo Rev 2 | TYPE | PRE DELAY | REVERB TIME | SPREAD | | | | |
| | | | HALL | 40 msec | 2.4 sec | 70% | | | | |
| P007 | LCR-DLY | Delay LCR | HI DAMP | DELAY TIME L | DELAY TIME C | DELAY TIME R | FEEDBACK | WET LEVEL L | WET LEVEL C | WET LEVEL R |
| | | | 10.1 kHz | 250 msec | 750 msec | 500 msec | 40 | 80 | 80 | 80 |
| P008 | MN-DLY | Mono Delay | DELAY TIME | FEEDBACK | HI DAMP | | | | | |
| | | | 500 msec | 40 | 10.1 kHz | | | | | |
| P009 | PP-DLY | Ping-Pong Delay | DELAY TIME | FEEDBACK | HI DAMP | | | | | |
| | | | 500 msec | 60 | 10.1 kHz | | | | | |
| P010 | ST-DLY | Stereo Delay | DELAY TIME | FEEDBACK | HI DAMP | | | | | |
| | | | 500 msec | 40 | 10.1 kHz | | | | | |
| P011 | CHORUS | Chorus | RATE | DEPTH | DELAY TIME | HI PASS | HI DAMP | SPREAD | | |
| | | | 0.25 Hz | 0% | 40 msec | 125 Hz | 3.36 kHz | 100% | | |
| P012 | FLANGER | Flanger | RATE | DEPTH | DELAY TIME | PHASE | | | | |
| | | | 0.20 Hz | 10% | 40 msec | 180 deg | | | | |
| P013 | PHASER | Phaser | RATE | STAGE | RESONANCE | PHASE | | | | |
| | | | 0.40 Hz | 8 | 2 | 180 deg | | | | |
| P014 | PITCH | Pitch | PITCH 1 | FINE 1 | PITCH 2 | FINE 2 | | | | |
| | | | 0 | -10 cent | 0 | +10 cent | | | | |

TASCAM

TEAC CORPORATION

Phone: +81-42-356-9143

1-47 Ochiai, Tama-shi, Tokyo 206-8530 Japan

<https://tascam.jp/jp/>

TEAC AMERICA, INC.

Phone: +1-323-726-0303

10410 Pioneer Blvd., Unit #1, Santa Fe Springs, California 90670, U.S.A

<https://tascam.com/us/>

TEAC UK Ltd.

Phone: +44-1923-797205

Luminous House, 300 South Row, Milton Keynes, Buckinghamshire, MK9 2FR, UK

<https://www.tascam.eu/en/>

TEAC EUROPE GmbH

Phone: +49-611-71580

Bahnstrasse 12, 65205 Wiesbaden-Erbenheim, Germany

<https://www.tascam.eu/de/>

TEAC SALES & TRADING(SHENZHEN) CO., LTD

Phone: +86-755-88311561~2

Room 817, Xinian Center A, Tairan Nine Road West, Shennan Road, Futian District, Shenzhen, Guangdong Province 518040, China

<https://tascam.cn/cn/>

0423. MA-3498C